

EXACT

PRÄZISIONSWERKZEUGE

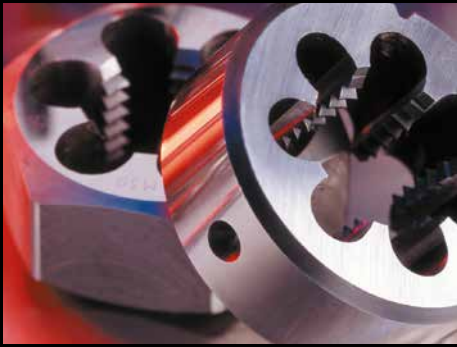

Vorsprung durch Innovation



EXACT entwickelt und produziert seit über 50 Jahren innovative Präzisionswerkzeuge auf höchstem Qualitätsniveau. Zahlreiche Produktentwicklungen zum Gewinden, Bohren, Senken und Entgraten stammen aus unserem Hause und belegen nachhaltig unsere Innovationskraft bei der Herstellung hochwertigster Präzisionswerkzeuge.

Mit der Investition in eine hoch moderne Vakuum-Beschichtungsanlage setzt EXACT auf neue, innovative Wege in der

Werkzeugveredelung und damit auf neue Werkzeug-Nutzungskonzepte auf Basis individueller Kundenwünsche für Werkzeuge höchster Fertigungsgüte zur Bearbeitung unterschiedlichster Materialien.

Die Zusammenführung modernster Fertigungs- und Beschichtungstechnologie unter einem Dach garantieren Ihnen höchsten Werkzeugstandard, optimale Standzeiten, hohe Effektivität und nicht zuletzt nachhaltig Prozesskostenoptimierung.

Leaping forward - with innovative solutions

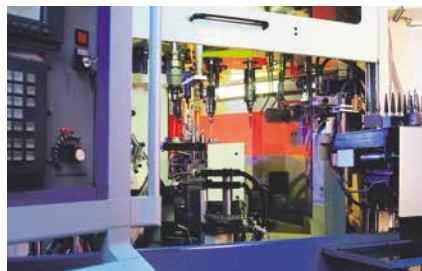

EXACT has been developing and manufacturing precision tools of the highest quality for over 50 years. Our company has developed countless products for threading, drilling, countersinking and deburring; products which bear lasting testimony to our innovative energy when it comes to the production of high-quality precision tools.

Having recently invested in a state-of-the-art vacuum coating plant, EXACT are now able to offer new and innovative

solutions that will further enhance our products. Allowing us to meet all our individual customer's needs with tools of the highest technical production quality.

By bringing together state-of-the-art production and coating technologies under one roof, we guarantee to offer you tools of the highest standard, optimum service lives, high effectiveness and, not least, process cost optimization.

EXACT
COATING TECHNOLOGIE

Werkzeugbeschichtung **Tool Coating**



Zu den wichtigsten Argumenten bei der Auswahl und dem Erwerb von professionellem Präzisionswerkzeug zählen Standzeit und Leistung. Hierbei wird die Wahl der richtigen Oberflächenbeschichtung immer mehr zu einem entscheidenden Wettbewerbsfaktor, denn neben der Fertigungsqualität der Werkzeuge beeinflusst die Beschichtung entscheidend die Standzeit eines Werkzeuges. Mit der Investition in eine hochmoderne Vakuum-Beschichtungsanlage setzen wir bei EXACT in enger Zusammenarbeit mit Forschungseinrichtungen und Instituten auf neue, innovative Wege in der Werkzeugveredelung.



Vorteile & Nutzen

- **Produktions-/Beschichtungskompetenz aus einer Hand**
- Weniger Verschleiß, weniger Ausfallzeiten
- Beschleunigung von Produktionsprozessen
- Neue Werkzeug-Nutzungskonzepte in Abstimmung auf individuelle Kundenanforderungen
- Prozesskostenoptimierung



When it comes to choosing and buying professional precision tools, two of the most important arguments are service life and performance. In this respect, the choice of the right surface coating is increasingly a critical competitive factor, because the coating not only influences the production quality of the tools, it also has a decisive influence on how long they last. With the investment in a highly modern vacuum coating plant, we at EXACT, in cooperation with research establishments and institutions, aim to make the most of new and innovative solutions for tool enhancement.



Advantages & benefits

- **Production and Coating competence from a single source**
- Less wear, less lost production time
- Acceleration of production processes
- New concepts for tool utilization in coordination with individual customer requirements
- Process cost optimization

Technische Information | Technical information

<p>TiN</p>	<p>Titan-Nitrid Beschichtung</p> <p>Farbe: Gold Schicht: Multilayer Gesamte Schichtstärke: bis 2 µm Oberflächenhärte: ca. 2.500 HV Temperaturbeständig: bis 600° C Kühlung: Nicht notwendig – wird aber empfohlen Anwendung: Für Baustahl, CrNi-Stahl, NE-Metalle und Kunststoffe etc. (Allround-Schicht)</p> <p>Vorteile: <ul style="list-style-type: none"> • Hohe Härte • Geringer Reibungskoeffizient • Erhöhte Standzeiten • Höhere Schnittgeschwindigkeit • Gute Wärmefestigkeit </p>	<p>Titan-Nitride Coating</p> <p>Colour: Gold Layer: Multilayer Layer thickness: up to 2 µm Surface hardness: approx. 2.500 HV Temperature resistant: up to 600° C Cooling: Not necessary but recommended Application: For steel, chrome-nickel steel, non-ferrous metal and plastic</p> <p>Advantages: <ul style="list-style-type: none"> • High surface hardness • Less coefficient of friction • Longer tool-life • Higher cutting speed </p>
<p>TiCN</p>	<p>Titan-Carbo-Nitrid Beschichtung</p> <p>Farbe: Violett/Purple Schicht: Multilayer Gesamte Schichtstärke: bis 4 µm Oberflächenhärte: ca. 3.000 HV Temperaturbeständig: bis 400° C Kühlung: Wird empfohlen Anwendung: Besonders geeignet für aufschmierende Werkstoffe (wie Aluminium & abrasive Materialien)</p> <p>Vorteile: <ul style="list-style-type: none"> • Erhöhte Standzeiten • Höhere Schnittgeschwindigkeit • Verbessertes Gleitverhalten </p>	<p>Titan-Carbo-Nitride Coating</p> <p>Colour: Violett/purple Layer: Multilayer Layer thickness: up to 4 µm Surface hardness: approx. 3.000 HV Temperature resistant: up to 400° C Cooling: Recommended Application: Good attitudes at greasy materials (like Aluminium & abrasive materials)</p> <p>Advantages: <ul style="list-style-type: none"> • Longer tool-life • Higher cutting speed </p>
<p>TitanPro</p>	<p>Titan-Pro Beschichtung</p> <p>Farbe: Violett Schicht: Multilayer Gesamte Schichtstärke: bis 2 µm Oberflächenhärte: ca. 3.100 HV Temperaturbeständig: bis 650° C Kühlung: Wird empfohlen Anwendung: Besonders geeignet für HSS und hochfeste Stähle</p> <p>Vorteile: <ul style="list-style-type: none"> • Sehr gutes Verschleißverhalten • Gute thermische Stabilität • Optimierte Schnittgeschwindigkeit </p>	<p>Titan-Pro Coating</p> <p>Colour: Violett Layer: Multilayer Layer thickness: up to 2 µm Surface hardness: approx. 3.100 HV Temperature resistant: up to 650° C Cooling: Recommended! Application: Especially suitable for application in HSS and hard metal</p> <p>Advantages: <ul style="list-style-type: none"> • Excellent wear resistance • High thermal stability • Optimised cutting speed </p>
<p>TiAlN</p>	<p>Titan-Aluminium-Nitrid Beschichtung</p> <p>Farbe: Schwarz-Violett Schicht: Multilayer Gesamte Schichtstärke: bis 4 µm Oberflächenhärte: ca. 3.500 HV Temperaturbeständig: bis 800° C Kühlung: Kein Kühlmittel notwendig Anwendung: Für hochabrasive Materialien und schwer spanbare Materialien</p> <p>Vorteile: <ul style="list-style-type: none"> • Zur Trockenerspanung geeignet • Keramische Oberfläche minimiert Reibung • Optimale Standzeiten • Höchste Schnittgeschwindigkeit • Deutliche Reduzierung von Aufbauschneiden </p>	<p>Titan-Aluminium-Nitride Coating</p> <p>Colour: Black-purple Layer: Multilayer Layer thickness: up to 4 µm Surface hardness: approx. 3.500 HV Temperature resistant: up to 800° C Cooling: Not necessary Application: Perfect for stainless steel cutting</p> <p>Advantages: <ul style="list-style-type: none"> • Dry cutting • Ceramic surface prevented friction • Longer tool-life • Highest cutting speed </p>
<p>VAP</p>	<p>Vaporisieren Aufdampfen einer nicht metallischen Oxydschicht. Wirkt als Trennschicht und vermindert Kaltaufschweißung.</p> <p>Vaporisation Steam tamping process. The nonferrous oxide film reduces cold-welding.</p>	

EXACT produziert und liefert Qualität ...
EXACT produces and delivers quality ...



Lager- und Produktions-Kapazitäten garantieren Liefersicherheit

Mit 6.000 Quadratmetern Nutzfläche verfügen wir an unserem Standort Bergisch Born über große Lagerkapazitäten für eine flexible Vorrats- und Bestandshaltung. Ein Vorteil, der maximale Liefer- und Wettbewerbsfähigkeit gewährleistet und das Vertrauen unserer Kunden in unser Leistungspotential stärkt.



Erfahrene und motivierte Mitarbeiter im Einsatz für unsere Kunden

Unser fachkundiges und engagiertes Mitarbeiterteam garantiert reibungslose Abläufe von der Materialbeschaffung, über die Fertigung und Qualitätskontrolle bis hin zur pünktlichen Auslieferung Ihrer Bestellung. Wir stehen Ihnen mit Rat und Tat zur Seite, gehen gerne auf Ihre speziellen Werkzeuganforderungen ein und finden mit Ihnen die optimalen Werkzeug-Lösungen für produktive und effiziente Arbeitsabläufe in Ihrem Hause.



Warehouse and production capacities for guaranteed delivery certainty

With 6,000 square meters of effective space available at our site in Bergisch Born, we have extensive warehouse capacity for keeping a flexible supply of stocks and inventories. An advantage which guarantees maximum delivery capability and competitiveness and also reinforces our customers' faith in our capabilities.



Experienced and motivated staff dedicated to serving our customers

Our expert and motivated team of staff guarantees smooth workflows at every stage, from procurement of materials, production and quality controls to the punctual delivery of your order. We are there to offer you practical advice, look forward to helping you with your specific tool requirements and finding the optimum tool solutions for productive and efficient workflows at your company.

... mit Sicherheit!
... you can count on!

Zertifiziertes Qualitätsmanagement belegt zukunftsorientiertes Handeln

Der hohe Qualitätsanspruch der EXACT GmbH & Co. KG Präzisionswerkzeuge ist mit dem Zertifikat DIN EN ISO 9001 geprüft, bestätigt und zertifiziert worden. Dabei steht neben der einwandfreien Produktqualität ebenso das ganzheitliche Denken und Handeln des Unternehmens im Focus, wie beispielsweise Innovationsstärke, Produktrealisierung, Management, Ressourcennutzung, Lieferfähigkeit und Zuverlässigkeit – und das weltweit.

Mit der Zertifizierung ist eine optimale Basis für die zukunftsorientierte Weiterentwicklung unseres Unternehmens geschaffen und stärkt das Vertrauen unserer Kunden in unser Leistungspotential.

Certified quality management attests to a future-oriented approach

The high quality standards of EXACT GmbH & Co. KG Präzisionswerkzeuge have been audited, verified and certified – with the DIN EN ISO 9001 certificate. In this connection the focus is not just on the company's flawless product quality but on its holistic approach in terms, for example, of innovativeness, product implementation, management, use of resources, delivery capability and reliability – and all that worldwide.

Certification has established an optimum basis for the future-oriented further development of our company and reinforces our customers' faith in our capabilities.



EXACT®



Das Produktprogramm ist in zwei Produktlinien unterteilt:
Die Premium-Marke EXACT® steht für Eigenfertigungsprodukte
"Made in Germany".

Premium-Marke EXACT®:

- **Made in Germany**
- Höchste, innovative Fertigungsqualität
- Ausschließlich eigene Herstellung
- Zahlreiche Produktinnovationen (Patente & Gebrauchsmuster)
- Breites, durchgängiges Sortiment
- Für höchste, industrielle Anforderungen in allen Anwendungsbereichen



Our range of products contains two lines: Premium brand EXACT®
be synonymous with own production "Made in Germany".

Premium brand EXACT®:

- **Made in Germany**
- Maximum, innovative production quality
- All products made exclusively in-house
- Numerous product innovations (patents & utility models)
- Wide, complete range of products
- For the highest industrial requirements in every area of application



EVENTUS® by EXACT

Die Handelsmarke EVENTUS® by EXACT bietet verlässliche Industriequalität zu einem überzeugenden Preis-/Leistungsverhältnis.

Handelsmarke EVENTUS® by EXACT:

- **Geprüfte und verlässliche Industriequalität nach technischen Vorgaben aus dem Hause EXACT**
- Optimales Preis-/Leistungsverhältnis
- Umfangreiche Produktauswahl
- Hochwertige Werkzeugqualität für alle Standard-Anwendungen

The brand EVENTUS® by EXACT provides reliable industrial quality with a good price/performance ratio.

EVENTUS® by EXACT:

- **Tested and reliable industrial quality in accordance with technical specifications from EXACT**
- Optimum value for money
- Wide range of products
- High-quality tools for all standard applications



INHALT | CONTENTS



GEWINDESORTIMENTE THREAD CUTTING ASSORTMENTS	14
---	-----------



HANDGEWINDE HAND TAPS	42
--	-----------



MASCHINENGEWINDE MACHINE TAPS	102
--	------------



STUFENBOHRER & BLECHSCHÄLBOHRER STEP DRILLS AND TUBE & SHEET DRILLS	156
--	------------



SENKER COUNTERSINKS	188
--------------------------------------	------------



BIT-PROGRAMM BIT-PROGRAM	214
---	------------



FRÄSSTIFTE ROTARY BURRS	226
--	------------



HANDENTGRATER HAND DEBURRING TOOLS	238
---	------------



LOCHSÄGEN HOLE SAWS	246
--------------------------------------	------------



SPIRALBOHRER TWIST DRILLS	252
--	------------



GEWINDEREPARATUR THREAD REPAIRING	308
--	------------



KERNBOHRER CORE DRILLS	328
---	------------

Handgewindebohrer	46 - 67
Schneideisen / Schneidmuttern	48 - 68
Einschnittgewindebohrer	80 - 81
Halbwerkzeuge	87 - 93
Zubehör	96 - 101

Universeller Einsatz	108 - 123
Stähle über 1.000 N/mm ²	124 - 127
VA + rostfreie Stähle	128 - 131
Guss Material	132
Zusätzliche Oberflächenhärtung	134 - 137
Spezial-Gewindebohrer	138 - 144

ADVANCEDLINE® 4-Nuten Stufenbohrer	158 - 161
Stufenbohrer	162 - 171
Spezial-Stufenbohrer	172 - 179
Bleeschälbohrer	180 - 187

ADVANCEDLINE® Hochleistungssenker	190 - 193
Kegelsenker 90° / 60° / 75° / 120°	194 - 207
Querlochsenker 90°	208 - 209
Flachsenker	210 - 213

Stufenbohrer-Bit	216
SGE-Bit® Kombigewindebohrer	217 - 219
Senk-Bit	220
Einschnittgewindebohrer-Bit	221
Spiralbohrer-Bit	222

Hartmetall Frässtifte	228 - 236
Sets & Display	237

Klingen	241
Handgriffe & Halter	240 / 242
Sets	244 / 245
Sortimente	242 - 243

Hartmetall Lochsägen	250
Zubehör Hartmetall Lochsägen	251
Zubehör Bi-Metall Lochsägen	251

Spiralbohrer DIN 338	256-271
Spiralbohrer DIN 340	272-273
Spiralbohrer DIN 345	274-276
Spiralbohrer DIN 1897	277-279
Sets DIN 338	280-285
Zusatzartikel	288-290

Kernbohrer 30mm	331
Kernbohrer 55mm	332
Sets 30 / 50 mm	333
Auswerfstift	333

Handgewindebohrer	70 - 78
Schneideisen / Schneidmuttern	72 - 79
Einschnittgewindebohrer	82 - 84
Halbwerkzeuge	87 - 93
Zubehör	96 - 101

Universeller Einsatz	148 - 151
Zusätzliche Oberflächenhärtung	152 - 155

HSS Bi-Metall Lochsägen	248
Sets HSS Bi-Metall Lochsägen	249

Spiralbohrer DIN 338	292-299
Spiralbohrer DIN 340	300
Spiralbohrer DIN 345	301-302
Sets DIN 338	304-307
Zusatzartikel	303

Sortimente M/Mf	312-314
Sets M/ Mf	315-316
Zubehör M/Mf	318-324

NEW

EXACT
PRÄZISIONSWERKZEUGE

BLACK BOX | BIT BOX | BLUE BOX

HIGH PERFORMANCE TOOL BOXES



Die innovativen Kompaktlösungen zur Metallbearbeitung.

The innovative compact solutions for metalworking.



Vorteile | Advantages

- Höchste Produktqualität
- Optimiertes Werkzeugkonzept
- Innovatives Produktdesign
- Optimised tool concept
- Innovative product design



BLACK BOX



Hochwertigste Qualitätswerkzeuge zur Metallbearbeitung für den professionellen, industriellen Einsatz.



	CODE	€ SET
BLACK BOX 23-teilig 23 pieces	70611	
1 Stufenbohrersatz, HSS, 3-teilig Step Drill Assortment, HSS, 3 pieces Ø 4-12 / 4-20 / 6-30 mm		
2 Kegelsenkersatz 90°, HSS, 6-teilig Countersink Assortment 90°, HSS, 6 pieces Ø 6,3 / 8,3 / 10,4 / 12,4 / 16,5 / 20,5 mm		
3 Maschinengewindebohrersatz, HSS-E, 14-teilig, Form B Machine Tap Assortment, HSS-E, 14 pieces, Form B M3 M4 M5 M6 M8 M10 M12 + Kernlochbohrer Twist Drills		

Die Kompaktlösung für Senk-, Bohr- und Gewindearbeiten

- Senken + Entgraten
- Bohren + Entgraten
- Schneiden von Innengewinden
- Countersinking + deburring
- Drilling + deburring
- Cutting internal threads

BIT BOX



Mit 1/4" Bit-Schaft speziell für den mobilen Einsatz bzw. für Arbeiten mit Akkuwerkzeugen.



	CODE	€ SET
BIT BOX 15-teilig 15 pieces	70612	
1 Stufenbohrer-Bit-Satz, HSS, 1/4", 3-teilig Step Drill Bit Assortment, HSS, 1/4", 3 pieces Ø 4-12 / 4-20 / 6-30 mm		
2 Senk-Bit-Satz, HSS, 1/4", 6-teilig Countersink-Bit Assortment, HSS, 1/4", 6 pieces Ø 6,3 / 8,3 / 10,4 / 12,4 / 16,5 / 20,5 mm		
3 SGE-Bit® Kombigewindebohrer-Satz, HSS, 1/4", 6-teilig SGE-Bit® Combi-tool Assortment, HSS, 1/4", 6 pieces		

Die Kompaktlösung für Senk-, Bohr- und Gewindearbeiten

- Senken + Entgraten
- Bohren + Entgraten
- Schneiden von Innengewinden
- Countersinking + deburring
- Drilling + deburring
- Cutting internal threads



GEWINDESORTIMENTE

THREAD CUTTING ASSORTMENTS

EXACT®

EVENTUS®
by EXACT

Hand- & Maschinengewinde

Hand Taps & Machine Taps

■ metrisch 19

Maschinengewinde

Machine Taps

■ metrisch 20-21 / 26

39

Handgewinde

Hand Taps

■ metrisch 22-23 / 27

32-36

■ metrisch fein 27

32-33

■ BSW 27

■ BSP (G) 25 / 27

■ UNC 27

■ UNF 27

Einschnittgewindebohrer

Short Machine Taps

■ metrisch 28

37

Schneideisen

Circular Dies

■ metrisch 29

37

Gewindereparatur

Thread Repairing

■ metrisch 24

Spezial Gewindesortimente

Special Thread Cutting Assortments

■ für Sanitärbranche 29

■ für Kabelverschraubungen 28

Aktionssortimente

Promotion Sets

■ Metallbearbeitung 17

■ Powerpacks 39

■ Gewindeschneidsortiment 40-41

STARTERKIT "METALL"

EXACT
PRÄZISIONSWERKZEUGE

35-teiliger Kunststoffkoffer inkl. Handbücher



NEU!



MEHR INFOS UNTER:
WWW.EXACT.INFO

Universalsortiment für die
Metallbearbeitung zum:

- +** Bohren
- +** Senken
- +** Entgraten
- +** Schneiden von Innen-
und Außengewinden



Sortimente • Assortments

Vorteile | Advantages



Innengewinde schneiden
Cut inner threads

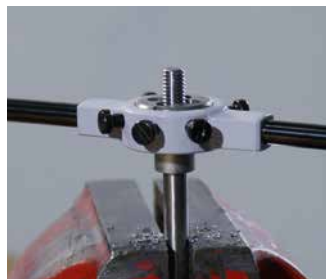

Außengewinde schneiden
Cut external threads



Senken & Entgraten
Countersink & Deburr



Stufenbohren
Step drilling



M3 – M12		CODE	€ SET
Metallbearbeitungs-Sortiment Metalworking Assortment • Einschnittgewindebohrer Short Machine Taps HSS, M3 – M4 – M5 – M6 – M8 – M10 – M12 + Schneideisen Circular Dies HSS, M3 – M4 – M5 – M6 – M8 – M10 – M12 + Schneideisenhalter Holder for Circular Dies HSS, 25 x 9 + Windeisen Tap Wrenches, 1 1/2 + Kernlochbohrer Twist Drills DIN 338 HSS-G, Ø 2,5 3,3 4,2 5,0 6,8 8,5 10,2 mm + Kegelsenker 90° Countersink 90° HSS, Ø 6,3 8,3 10,4 12,4 16,5 20,5 mm + Stufenbohrer Step Drills HSS, Ø 4-12 4-20 6-30 mm + Gewindelehre Thread Gauge Inkl. Handbücher "Gewindeschneiden" & "Bohren und Senken"			
HSS	M3 – M12 33-teilig 33 pieces	70633	



Übersicht | Overview

Hand- & Maschinengewindebohrer-Sortiment
Hand- & Machine Tap Assortment



GS61

61-teilig | 61 pieces

S. 19 | page 19

Gewindereparatur-Sortiment
Thread Repairing Assortment



GR130

130-teilig | 130 pieces

S. 24 | page 24

Maschinengewindebohrer-Sortiment
Machine Tap Assortment



GS18

18-teilig | 18 pieces

S. 20 | page 20

Maschinengewindebohrer-Sortiment
Machine Tap Assortment



GS18 Spezial

22-teilig | 22 pieces

S. 21 | page 21

Handgewindebohrer-Sortiment
Hand Tap Assortment



GS32

32-teilig | 32 pieces

S. 22 | page 22

Handgewindebohrer-Sortiment
Hand Tap Assortment



GS32 Spezial

36-teilig | 36 pieces

S. 23 | page 23

Maschinengewindebohrer-Sortiment
Machine Tap Assortment



Magazin I

61-teilig | 61 pieces

S. 26 | page 26

Maschinengewindebohrer-Sortiment
Machine Tap Assortment



Magazin II

124-teilig | 124 pieces

S. 26 | page 26

Handgewindebohrer-Sortiment
Hand Tap Assortment



S12 Sanitär

12-teilig | 12 pieces

S. 25 | page 25

Handgewindebohrer-Sortiment
Hand Tap Assortment



Holz Spezial

div. Varianten | different variations

S. 27 | page 27



Premium Gewindeschneidsortimente Premium Thread Cutting Assortments

EXACT
PRÄZISIONSWERKZEUGE

Sortimente • Assortments

M3 - M12

GS61

HSS

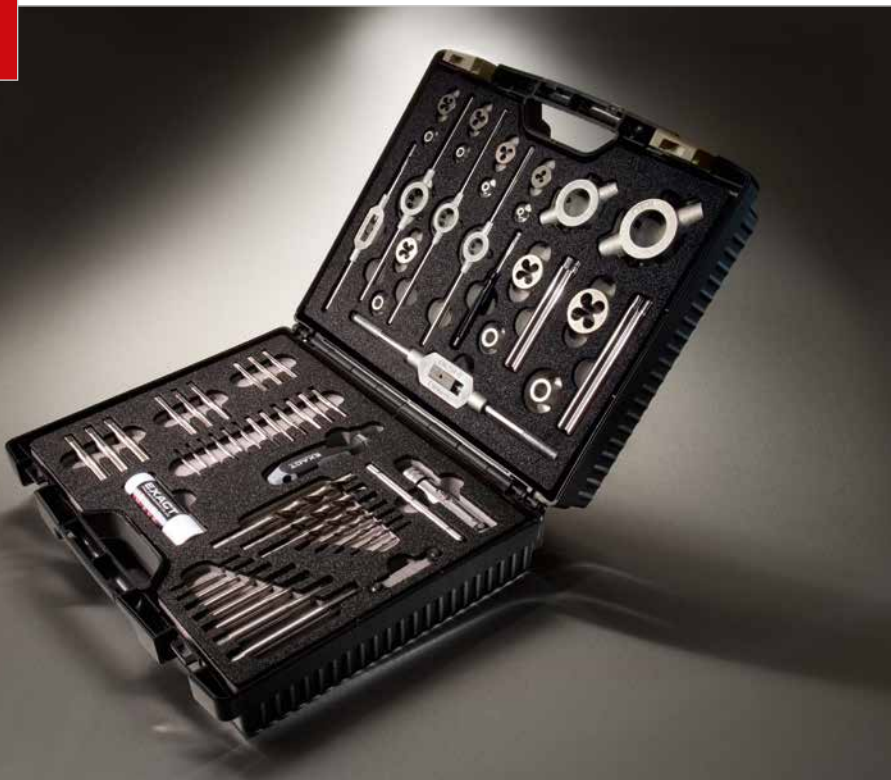

**INKLUSIVE
HANDBUCH
Gewindeschneiden**



Vorteile | Advantages



Optimiertes Werkzeugkonzept
Optimised tool configuration



2-farbiges "Tool-Control-System"
2-coloured "Tool-Control-System"



Schaumstoffinlays herausnehmbar
Removable inlays



Koffer rutschsicher und stapelbar
Non-slip and stackable toolboxes



GS61	M3 - M12	CODE	€ SET
	<p>Hand- & Maschinengewindebohrer-Sortiment Hand & Machine Tap Assortment</p> <ul style="list-style-type: none"> • Handgewindebohrer Hand Taps DIN 352, M3 – M12, Vor-, Mittel-, Fertigschneider • Maschinengewindebohrer Machine Taps DIN 371-376, Form B, M3 – M12 • Schneidisen Circular Dies DIN 223, M3 – M12 • Führungen Guides DIN 223, M3 – M12 • Schneidisenhalter Holder for Circular Dies GD DIN 225, 20x5 20x7 25x9 30x11 38x14 • Verstellbare Windeisen Adjustable Teap Wrenches DIN 1814, Gr. 1 und 2 • Handentgräter Hand Deburring Tool 12,4 mm • Spiralbohrer Twist Drills DIN 338, Ø 2,5 3,3 4,2 5,0 6,8 8,5 10,2 mm <p>+ Gewindehandbuch Thread Cutting Guide + Werkzeughalter Toolholder Gr. 2 + Bohrpaste Drilling paste 20 g + Gewindelehre Gauge + Schraubendreher Screw Driver</p>		
HSS	M3 – M12 61-teilig 61 pieces	70511	
HSS-E	M3 – M12 61-teilig 61 pieces	70521	



Sortimente • Assortments

GS18

M3 - M12

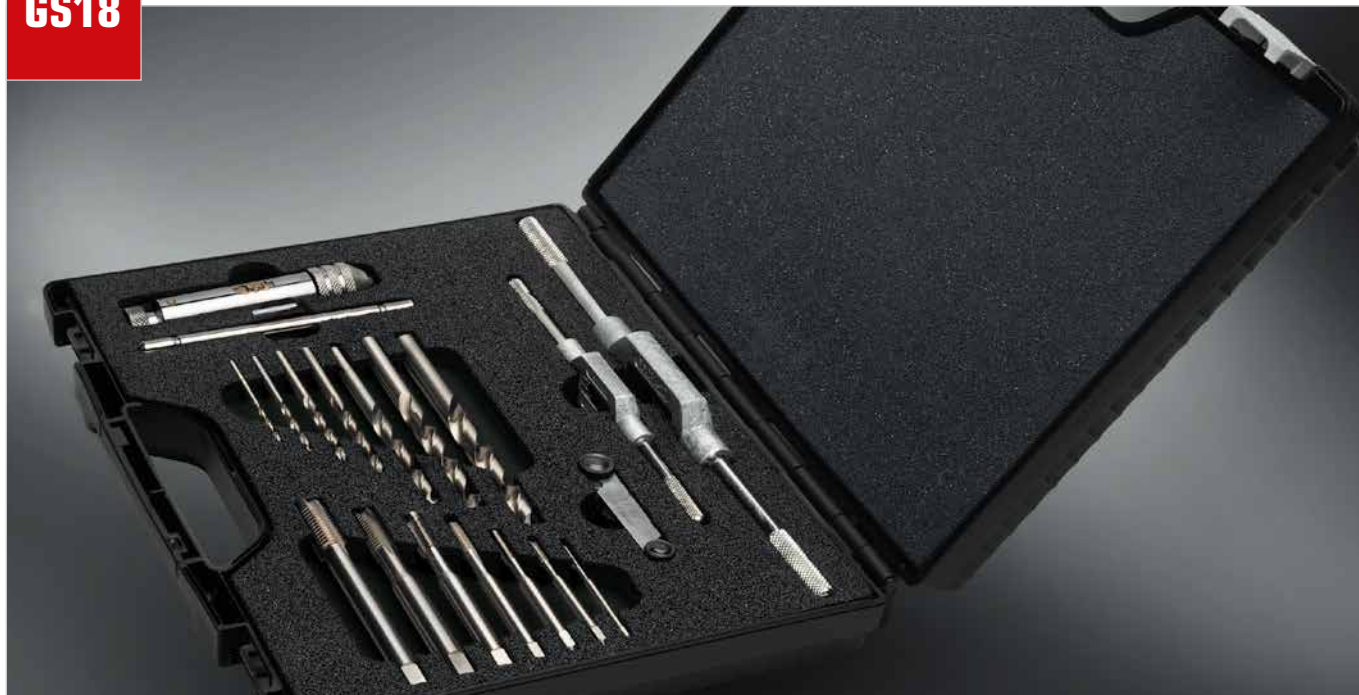

Vorteile | Advantages



Optimiertes Werkzeugkonzept
Optimised tool configuration



Innovatives Produktdesign
Innovative product design



Schaumstoffinlays herausnehmbar
Removable inlays



Koffer rutschsicher und stapelbar
Non-slip and stackable toolboxes



GS18	M3 - M12	CODE	€ SET
	Maschinengewindebohrer-Sortiment Machine Tap Assortment <ul style="list-style-type: none"> • Maschinengewindebohrer Machine Taps DIN 371-376, M3 - M4 - M5 - M6 - M8 - M10 - M12 + Verstellbare Windeisen Adjustable Teap Wrenches DIN 1814 Gr. 1 + 2 + Spiralbohrer Twist Drills DIN 338, Ø 2,5 3,3 4,2 5,0 6,8 8,5 10,2 mm + Werkzeughalter Toolholder Gr. 2 + Gewindelehre Gauge Standard 		
HSS Form B	M3 - M12 18-teilig 18 pieces	70531	
HSS-E Form B	M3 - M12 18-teilig 18 pieces	70541	
HSS 35°RSP	M3 - M12 18-teilig 18 pieces	70532	
HSS-E 35°RSP	M3 - M12 18-teilig 18 pieces	70542	



Premium Gewindeschneidsortimente Premium Thread Cutting Assortments

EXACT
PRÄZISIONSWERKZEUGE

**GS18
Spezial**

M3 - M12



**INKLUSIVE
HANDBUCH
Gewindeschneiden**



Sortimente • Assortments

Vorteile | Advantages



Optimiertes Werkzeugkonzept
Optimised tool configuration



Innovatives Produktdesign
Innovative product design



Schaumstoffinlays herausnehmbar
Removable inlays



Koffer rutschsicher und stapelbar
Non-slip and stackable toolboxes



GS18 Spezial	M3 - M12	CODE	€ SET
	Maschinengewindebohrer-Sortiment Machine Tap Assortment <ul style="list-style-type: none"> wie GS18 like GS18 + Schneidölspray Cutting Spray 50 ml + Gewindelehre Gauge + Digitaler Messschieber Digital Caliper + Gewindehandbuch Thread Cutting Guide 		
HSS Form B	M3 - M12 22-teilig 22 pieces	70533	
HSS-E Form B	M3 - M12 22-teilig 22 pieces	70543	
HSS 35°RSP	M3 - M12 22-teilig 22 pieces	70534	
HSS-E 35°RSP	M3 - M12 22-teilig 22 pieces	70544	



Premium Gewindeschneidsortimente Premium Thread Cutting Assortments

EXACT
PRÄZISIONSWERKZEUGE

Sortimente • Assortments

GS32

M3 - M12



Vorteile | Advantages



Optimiertes Werkzeugkonzept
Optimised tool configuration



2-farbiges "Tool-Control-System"
2-coloured "Tool-Control-System"



Schaumstoffinlays herausnehmbar
Removable inlays



Koffer rutschsicher und stapelbar
Non-slip and stackable toolboxes



GS32	M3 - M12	CODE 	€ SET
	Handgewindebohrer-Sortiment Hand Tap Assortment <ul style="list-style-type: none"> • Handgewindebohrer Hand Taps DIN 352, M3 - M4 - M5 - M6 - M8 - M10 - M12 + Verstellbare Windeisen Adjustable Teap Wrenches DIN 1814 Gr. 1 + 2 + Spiralbohrer Twist Drills DIN 338, Ø 2,5 3,3 4,2 5,0 6,8 8,5 10,2 mm + Werkzeughalter Toolholder Gr. 2 + Gewindelehre Gauge Standard 		
HSS	M3 - M12 32-teilig 32 pieces	70551	
HSS-E	M3 - M12 32-teilig 32 pieces	70561	



Premium Gewindeschneidsortimente Premium Thread Cutting Assortments

EXACT
PRÄZISIONSWERKZEUGE

**GS32
Spezial**

M3 - M12



**INKLUSIVE
HANDBUCH
Gewindeschneiden**



Sortimente • Assortments

Vorteile | Advantages



**Optimiertes Werkzeugkonzept
Optimised tool configuration**



**Innovatives Produktdesign
Innovative product design**



**Schaumstoffinlays herausnehmbar
Removable inlays**



**Koffer rutschsicher und stapelbar
Non-slip and stackable toolboxes**



<p>GS32 Spezial</p>	<p>M3 - M12</p>	<p>CODE ✍</p>	<p>€ SET</p>
<p>Handgewindebohrer-Sortiment Hand Tap Assortment</p> <ul style="list-style-type: none"> • wie GS32 like GS32 + Schneidöl spray Cutting Spray 50 ml + Gewindelehre Gauge + Digitaler Messschieber Digital Caliper + Gewindehandbuch Thread Cutting Guide 			
<p>HSS</p>	<p>M3 - M12 36-teilig 36 pieces</p>	<p>70562</p>	



Premium Gewindereparatursortiment Premium Thread Repairing Assortment

EXACT
PRÄZISIONSWERKZEUGE

M3 - M12

GR130



✓ **Integriertes Nachfüllsystem
inkl. 105 Gewindeeinsätze
in unterschiedlichen
Abmessungen**

**Integrated refill System
Including 105 inserts in
different dimensions**



Anwendung

1. Beschädigtes Gewinde mit dem Spiralbohrer aufbohren.
2. Mit dem Gewindebohrer das Aufnahmegewinde in das aufgebohrte Loch schneiden.
3. Die passenden Gewindeeinsätze in Gewinderichtung mit dem Eindrehwerkzeug eindrehen.
4. Das Eindrehwerkzeug herausnehmen und den Mitnehmerzapfen mit dem Zapfenbrecher entfernen.

Nach Beendigung der Arbeitsvorgänge ist durch die engen Toleranzen sowie die Formung der Gewindeeinsätze ein Gewinde entstanden, welches oft besser und stärker ist als das ursprüngliche Gewinde.

Application

1. Drill open the damaged threads with a twist drill.
2. Tap the tap hole in the bored out hole using the screw tap.
3. Screw in the thread inserts in the direction of the thread using the screwing in die.
4. Take out the screwing in die and remove the drive stub with the drive stub breaker.

Once these operations have been completed, the thread will often be better and stronger than the original because of the close tolerances and the shape of the thread inserts.

Vorteile | Advantages



Optimiertes Werkzeugkonzept
Optimised tool configuration



Innovatives Produktdesign
Innovative product design

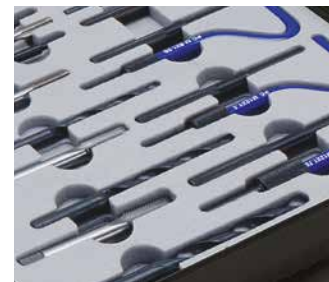

Schaumstoffinlays herausnehmbar
Removable inlays



Koffer rutschsicher und stapelbar
Non-slip and stackable toolboxes



GR130	M3 - M12	CODE	€ SET
Gewindereparatur-Sortiment Thread Repairing Assortment <ul style="list-style-type: none"> • Gewindeeinsätze Thread Inserts je 5 x M3 (1,0) / M3 (1,5) / M3 (2,5) / M4 (1,0) / M4 (1,5) / M4 (2,5) / M5 (1,0) / M5 (2,5) / M6 (1,0) / M6 (1,5) / M6 (2,5) / M8 (1,0) / M8 (1,5) / M8 (2,5) / M10 (1,0) / M10 (1,5) / M10 (2,5) / M12 (1,0) / M12 (1,5) / M12 (2,5) + Gewindebohrer Taps je 1 x M3 / M4 / M5 / M6 / M8 / M10 / M12 + Einbauwerkzeuge Fitting tools je 1 x M3 / M4 / M5 / M6 / M8x1,25 / M10x1,5 / M12x1,75 + Zapfenbrecher Pin-Breakers je 1 x M3 / M4 / M5 / M6 / M8x1,25 / M10x1,5 / M12x1,75 + Spiralbohrer Twist Drills je 1 x für M3x0,5 / M4x0,7 / M5x0,8 / M6x1,0 / M8x1,25 / M10x1,5 / M12x1,75 			
HSS	M3 - M12 130-teilig 130 pieces	40341	

Weitere Gewindereparatursets S. 312-314 | Other Thread Repairing Sets pages 312-314



Premium Gewindeschneidsortimente Premium Thread Cutting Assortments

EXACT
PRÄZISIONSWERKZEUGE

Sortimente • Assortments

1/8" - 1" BSP (G)

S12



G
BSP Whitworth Rohrgewinde
Whitworth pipe thread



Vorteile | Advantages



Optimiertes Werkzeugkonzept
Optimised tool configuration



Innovatives Produktdesign
Innovative product design



Schaumstoffinlays herausnehmbar
Removable inlays



Koffer rutschsicher und stapelbar
Non-slip and stackable toolboxes



S12	1/8" - 1"	CODE 	€ SET
<p>Sanitär-Gewindeschneidsortiment Thread Cutting Assortment</p> <ul style="list-style-type: none"> Einschnittgewindebohrer Short Machine Taps DIN 5157 BSP (G) 1/8" - 1/4" - 3/8" - 1/2" - 3/4" - 1" + Sechskant Schneidmutter Hexagon Die Nut DIN 382 BSP (G) 1/8" - 1/4" - 3/8" - 1/2" - 3/4" - 1" 			
HSS	1/8" - 1" für zylindrisches Rohrgewinde 12-teilig 1/8" - 1" for cylindrical pipe thread 12 pieces	70565	



M3 - M12

Magazin I



Inhalt | Contents

- 60 x Maschinengewindebohrer
Machine Taps DIN 371/376:
10 x M 3
10 x M 4
10 x M 5
10 x M 6
10 x M 8
5 x M10
5 x M12
- inklusive Bohrpaste | Drilling paste

HSS-E Form B	M3 - M12	CODE	€ SET
●	GELBRING für universellen Einsatz for universal using M3 - M12 61-teilig 61 pieces	Auf Anfrage	
○	ROTRING für Stähle über 1.000 N/mm ² for steel over 1000 N/mm ² M3 - M12 61-teilig 61 pieces	Auf Anfrage	
●	BLAURING für VA / INOX und rostfreie Stähle for stainless steel M3 - M12 61-teilig 61 pieces	Auf Anfrage	

M3 - M12

Magazin II



Inhalt | Contents

- Maschinengewindebohrer
Machine Taps DIN 371/376:
10 x M 3
10 x M 4
10 x M 5
10 x M 6
10 x M 8
5 x M10
5 x M12
- + **60 Spiralbohrer | Twist Drills:**
10 x 2,5 mm
10 x 3,3 mm
10 x 4,2 mm
10 x 5,0 mm
10 x 6,8 mm
5 x 8,5 mm
5 x 10,2 mm
- + **3 Kegelsenker | Countersinks:**
je 1 x Ø 6,3 / 10,4 / 12,4 mm
- inklusive Bohrpaste | Drilling paste

HSS-E Form B	M3 - M12	CODE	€ SET
●	GELBRING für universellen Einsatz for universal using M3 - M12 124-teilig 124 pieces	Auf Anfrage	
○	ROTRING für Stähle über 1.000 N/mm ² for steel over 1000 N/mm ² M3 - M12 124-teilig 124 pieces	Auf Anfrage	
●	BLAURING für VA / INOX und rostfreie Stähle for stainless steel M3 - M12 124-teilig 124 pieces	Auf Anfrage	



Premium Gewindeschneidsortimente

Premium Thread Cutting Assortments

EXACT
PRÄZISIONSWERKZEUGE

Sortimente • Assortments

**Holz
Spezial**

HSS | HSS



Ausführungen | Variations

M	metrisch metric
Mf	metrisch fein metric fine
BSW	Whitworth Gewinde Whitworth thread
UNC	Unified Grobgewinde Unified coarse thread
UNF	Unified Feingewinde Unified fine thread
G BSP	Whitworth Rohrgewinde Whitworth pipe thread

Technische Information

HSS = Hochleistungsschnell-Stahl

Anwendung

Handgewindebohrer, Schneideisen und Schneideisenhalter zum Schneiden von Gewinden.

Technical Information

HSS = High-speed-steel

Application

Hand Taps, Circular Dies and Holder for Circular Dies for cutting threads.



No.	i	INHALT	CODE	€ SET
M	M 3 – M16 44-teilig	Handgewindebohrer und Schneideisen Hand Taps and Circular Dies: M3 - M4 - M5 - M6 - M8 - M12 - M14 - M16 Schneideisenhalter Holder for Circular Dies: 20x5 - 20x7 - 25x9 - 30x11 - 38x14 - 45x18 Windeisen Tap wrenches: Gr. 1 + 3	05175	
Mf	Mf 6 – Mf 20 27-teilig	Handgewindebohrer und Schneideisen Hand Taps and Circular Dies: M6x0,75 - M8x0,75 - M8x1,0 - M10x1,0 - M12x1,5 - M14x1,25 - M14x1,5 - M16x1,5 - M18x1,5 - M20x1,5 Schneideisenhalter Holder for Circular Dies: 20x7 - 25x9 - 30x11 - 38x10 - 45x14 Windeisen Tap wrenches: Gr. 1 + 3	05176	
	Mf 6 – Mf 24 32-teilig	Handgewindebohrer und Schneideisen Hand Taps and Circular Dies: M6x0,75 - M8x0,75 - M8x1,0 - M10x1,0 - M12x1,5 - M14x1,25 - M14x1,5 - M16x1,5 - M18x1,5 - M20x1,5 - M22x1,5 - M24x1,5 Schneideisenhalter Holder for Circular Dies: 20x7 - 25x9 - 30x11 - 38x14 - 45x14 - 55x16 Windeisen Tap wrenches: Gr. 2 + 4	05177	
BSW	1/8" – 1/2" 28-teilig	Handgewindebohrer und Schneideisen Hand Taps and Circular Dies: 1/8 - 3/16 - 1/4 - 5/16 - 3/8 - 7/16 - 1/2 Schneideisenhalter Holder for Circular Dies: 20x5 - 20x7 - 25x9 - 30x11 - 38x14 Windeisen Tap wrenches: Gr. 1 + 2	05178	
	1/4" – 3/4" 28-teilig	Handgewindebohrer und Schneideisen Hand Taps and Circular Dies: 1/4 - 5/16 - 3/8 - 7/16 - 1/2 - 5/8 - 3/4 Schneideisenhalter Holder for Circular Dies: 20x7 - 25x9 - 30x11 - 38x14 - 45x18 Windeisen Tap wrenches: Gr. 1 + 3	05179	
	1/4" – 1" 35-teilig	Handgewindebohrer und Schneideisen Hand Taps and Circular Dies: 1/4 - 5/16 - 3/8 - 7/16 - 1/2 - 5/8 - 3/4 - 7/8 - 1" Schneideisenhalter Holder for Circular Dies: 20x7 - 25x9 - 30x11 - 38x14 - 45x18 - 55x22 Windeisen Tap wrenches: Gr. 2 + 4	05180	
UNC	1/4" – 3/4" 28-teilig	Handgewindebohrer und Schneideisen Hand Taps and Circular Dies: 1/4 - 5/16 - 3/8 - 7/16 - 1/2 - 5/8 - 3/4 Schneideisenhalter Holder for Circular Dies: 20x7 - 25x9 - 30x11 - 38x14 - 45x18 Windeisen Tap wrenches: Gr. 1 + 3	05181	
	1/4" – 1" 35-teilig	Handgewindebohrer und Schneideisen Hand Taps and Circular Dies: 1/4 - 5/16 - 3/8 - 7/16 - 1/2 - 5/8 - 3/4 - 7/8 - 1" Schneideisenhalter Holder for Circular Dies: 20x7 - 25x9 - 30x11 - 38x14 - 45x18 - 55x22 Windeisen Tap wrenches: Gr. 2 + 4	05182	
UNF	1/4" – 3/4" 21-teilig	Handgewindebohrer und Schneideisen Hand Taps and Circular Dies: 1/4 - 5/16 - 3/8 - 7/16 - 1/2 - 5/8 - 3/4 Schneideisenhalter Holder for Circular Dies: 20x7 - 25x9 - 30x11 - 38x10 - 45x14 Windeisen Tap wrenches: Gr. 1 + 3	05183	
	1/4" – 1" 26-teilig	Handgewindebohrer und Schneideisen Hand Taps and Circular Dies: 1/4 - 5/16 - 3/8 - 7/16 - 1/2 - 5/8 - 3/4 - 7/8 - 1" Schneideisenhalter Holder for Circular Dies: 20x7 - 25x9 - 30x11 - 38x10 - 45x14 - 55x16 Windeisen Tap wrenches: Gr. 2 + 4	05184	
BSP (G)	1/8" – 1" 21-teilig	Handgewindebohrer und Schneideisen Hand Taps and Circular Dies: 1/8 - 1/4 - 3/8 - 1/2 - 5/8 - 3/4 - 1" Schneideisenhalter Holder for Circular Dies: 30x11 - 38x10 - 45x14 - 55x16 - 65x18 Windeisen Tap wrenches: Gr. 3 + 5	05185	



Produktinformation | Product information

Artikel für Kabelverschraubungen

Die Gewinde sind metrische ISO-Feingewinde, jeweils mit einer Steigung von 1,5 mm bei allen Maßen. Bei Verteilerschränken mit Wandstärken bis max. 3 - 5,5 mm, werden die Kabelverschraubung in das Gehäuse verschraubt. Mit einem unserer Stufenbohrer wird, wie unten beschrieben, das Gewindekernloch gebohrt. Für das entsprechende Gewinde haben wir Spezial-Einschnitt-Gewindebohrer entwickelt (M 12 - M 32). Unsere Einschnitt-Gewindebohrer verfügen über eine lange Pilotspitze mit der das Werkzeug in der Bohrung fixiert wird, um ein 100% fluchtendes Gewinde auch bei einseitigem Druck zu erzeugen. Den Antrieb des Gewindebohrers haben wir so konstruiert, daß man ihn mit einem handelsüblichen Sechskanteinsatz („Nuß“) und einer Knarre im Einhandbetrieb betätigen kann. Diese Art des Antriebes ist zeit- und platzsparend, im Vergleich zu einem Einsatz mit DIN Handgewindebohrern und Windeisen (Ausladung des Windeisens bis zu 75 cm).

EXACT Stufenbohrer HSS mit Spiralnute und „Kantenbrecher“ Zone (DBGM) decken das gesamte Spektrum der Gehäuse-Öffnungen der neuen Norm M12 bis M 32 (EC 10) bzw. M 12 bis M 40 (EC 20) ab. Die Stufenbohrer haben jeweils eine kurze (3 mm) Bohrstufe für die Kabeldurchlässe in dünnwandige Gehäuse (Wandstärke max. 2 mm), sowie eine lange (6mm) Bohrstufe für Gewindekernlöcher in Verteilerschränken (Wandstärke max. 3 - 5,5 mm). Je nach Anwendungsintensität bieten wir die Stufenbohrer in blanker Ausführung, sowie mit TiN (Titan-Nitrid) und TiAlN (Titan-Aluminium-Nitrid) Beschichtungen an. Vorteile, speziell der EXACT-Stufenbohrer: Mit der spiralförmigen Nute (DBGM) erhalten wir ein verbessertes Arbeitsergebnis durch optimale Spanabfuhr, ruhigeres Schneidverhalten, längere Lebensdauer auf Grund verlängerter Schneidkanten, und weniger Kratzer auf dem Material durch kontrollierte Spanabfuhr. Mit Hilfe des „Kantenbrechers“ (DBGM) ist es möglich, die Bohrungen in Gehäusen (bis 1,5 mm Materialstärke) von beiden Seiten in einem Arbeitsgang zu entgraten. Der Einsatz eines zusätzlichen Entgratwerkzeuges wird überflüssig.

Gewinde Kernloch (6 mm Stufenhöhe)

∅	7	10.5	14.5	18.5	23.5	30.5
Gewinde	-	M12x1.5	M16x1.5	M20x1.5	M25x1.5	M32x1.5

Durchgangslöcher (3 mm Stufenhöhe)

∅	12.5	16.5	20.5	25.5	32.5
Gewinde	M12x1.5	M16x1.5	M20x1.5	M25x1.5	M32.5x1.5

Articles for Cable Connections

The threads are metric ISO-fine threads, each with a 1.5 pitch for all sizes. Cable screw connections are screwed into the cabinets with wall depths up to max. 3 - 5.5 mm. The core hole is drilled, as described below, with one of our step drills. We have designed a special short Tap (M 12 – M 32) for the respective threads. Our special short Taps are designed with a long pilot guid which fixes the tool in the bore, thus enabling the generating of threads which are 100% aligned even with single-sided pressure. We have designed the tap's drive such that one can use it single-handedly with a commercially available hex-head insert (nut) and a ratchet. This type of drive is time and space-saving when compared to DIN hand taps and tap wrenches (tap wrench swings of up to 750 mm).

EXACT HSS step drills with spiral flute and "Edge Breaker" zone (DBGM) cover the complete spectrum of electrician holes as per the new M12 to M32 (EC 10) specification, alternatively M 12 to M 40 (EC 20). The step drills have a short (3 mm) drill step for cable through-holes of thin-walled cabinets (max. 2 mm wall depth) as well as a long (6mm) drill step for tapping core holes in distributor cabinets (max. 3 - 5.5 mm wall depth) for every one of the individual metric diameters. We offer application-oriented step drills, e.g. without coating or as well as TiN (titanium-nitride) and TiAlN (titanium-aluminium-nitride) coated designs. Especial advantage of the EXACT-step drills: the spiral shaped flute (DBGM) enables an improved machining result due to optimal chip removal, smoother cutting characteristics, increased life-span due to increased cutting-edge lengths and scratches on the material due to controlled chip removal. Using the "Edge Breaker" (DBGM) capability it is possible to deburr the cabinet bores (up to 1.5 mm material thickness) from both sides in one machining step, thus eliminating the need for an extra deburring tool.

Thread Core Hole (6 mm Steps)



∅	7	10.5	14.5	18.5	23.5	30.5
Thread	-	M12x1.5	M16x1.5	M20x1.5	M25x1.5	M32x1.5

Trough Holes (3 mm Steps)

∅	12.5	16.5	20.5	25.5	32.5
Thread	M12x1.5	M16x1.5	M20x1.5	M25x1.5	M32.5x1.5

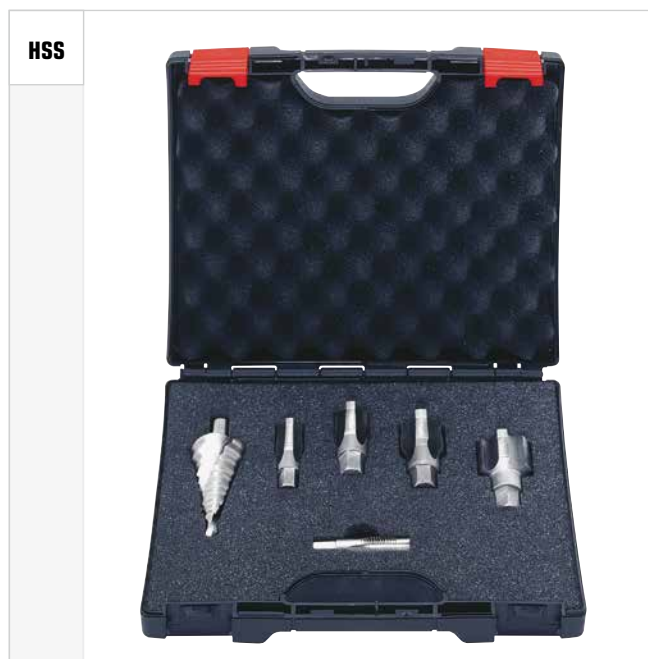
Elektro-Sortiment | Electric Assortment



 INHALT	 CODE	 SET
Spezial-Einschnittgewindebohrer Special Taps Mf 12x1,5 / Mf 16x1,5 / Mf 20x1,5 / Mf 25x1,5 / Mf 32 x 1,5 Stufenbohrer mit Spiralnute Step Drill with spiral flute EC 10 für ∅ 7 - 32,5 / M 12x1,5 / M 32x1,5	05979	



Spezial-Einschnittgewindebohrer | Special Taps



HSS

Technische Information

HSS = Hochleistungsschnell-Stahl
Für metrisches ISO-Feingewinde DIN 13, Toleranz 6H

Anwendung

Kurze Ausführung mit Sechskant-Antrieb für Einhandarbeit auch an schlecht zugänglichen Stellen. Führungszapfen für Gewindekernlöcher für einwandfreie, fluchtende Gewinde. Antrieb mit Nuss und Knarre.

Technical Information

HSS = High-speed-steel
For metric ISO-fine thread DIN 13, tolerance 6H

Application

Short design with hexagon shaft for one-hand working. With guide pins for thread coreholes for precise alignment of threads. Drive with socket and ratchet handle.

Mf	mm	mm	mm	mm	mm	CODE	€
Mf 12,0	1,50	10,5	16,5	51	SW 8	05971	
Mf 16,0	1,50	14,5	16,5	51	SW 10	05972	
Mf 20,0	1,50	18,5	16,5	51	SW 13	05973	
Mf 25,0	1,50	23,5	16,5	51	SW 13	05974	
Mf 32,0	1,50	30,5	16,5	51	SW 13	05975	
Mf 40,0	1,50	38,5	16,5	51	SW 13	05976	

Schneideisen-Set | Set of Circular Dies

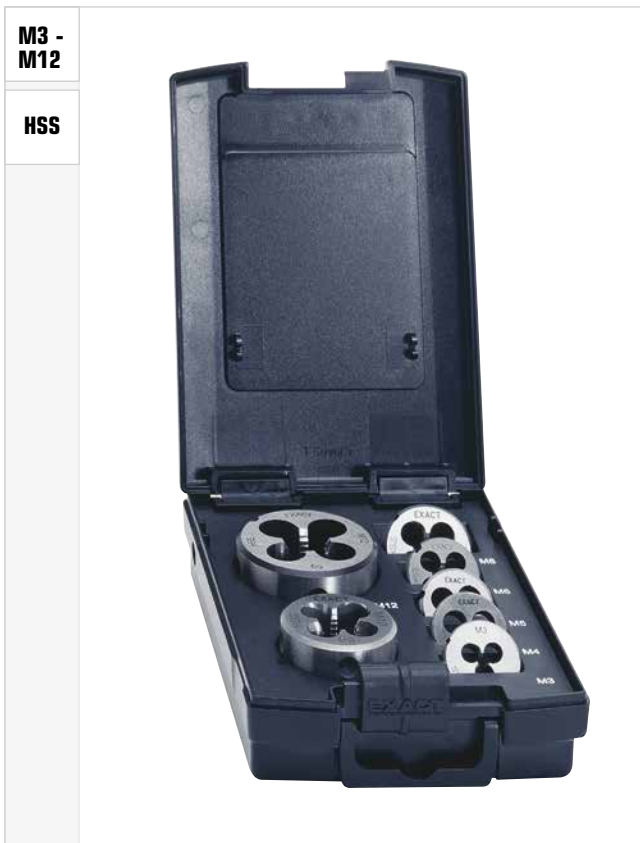

M3 - M12

HSS

Technische Information

Schneideisen liefern wir in vorgeschlitzter (geschlossener) Ausführung. Sie sind für den allgemeinen Einsatz, z.B. für Stähle bis 900 N/mm², geeignet. Für VA-Materialien verwenden Sie unsere Schneideisen aus HSS-E.

Toleranzen

2A **6g** Normale Gewindeverbindung

Technical Information

We can supply dies ready with slot (closed version). These are suitable for general use, e.g. in steel up to 900 N/mm². For VA materials, please use our dies made of HSS-E.

Tolerances

2A **6g** Thread with normal clearance

INHALT	CODE	€ SET
Schneideisen Circular Dies M3 - M4 - M5 - M6 - M8 - M10 - M12	03751	

EVENTUS STM-15S

EVENTUS
by EXACT

Abmessungen • Measurement
M3 / M4 / M5 / M6 / M8 / M10 / M12
Gr. 1 und Gr. 2

Wrenches DIN 1814 Zinc pressure casting
Dies DIN 225 Zinc pressure casting
20x5 / 20x7 / 4,2 / 5,0 / 6,8 / 8,5 / 10,2 mm

www.eventus-tools.de

Werkzeuge

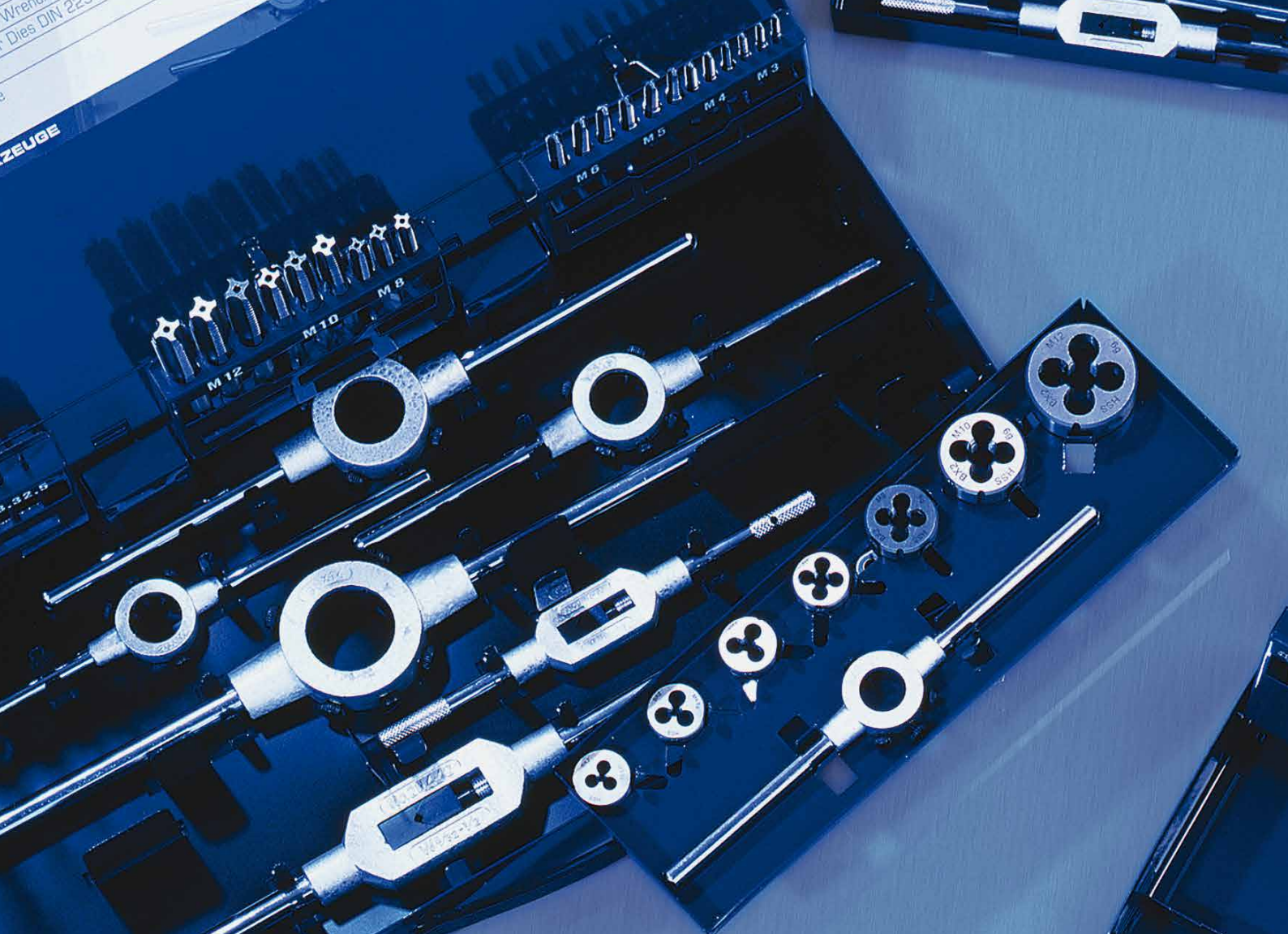

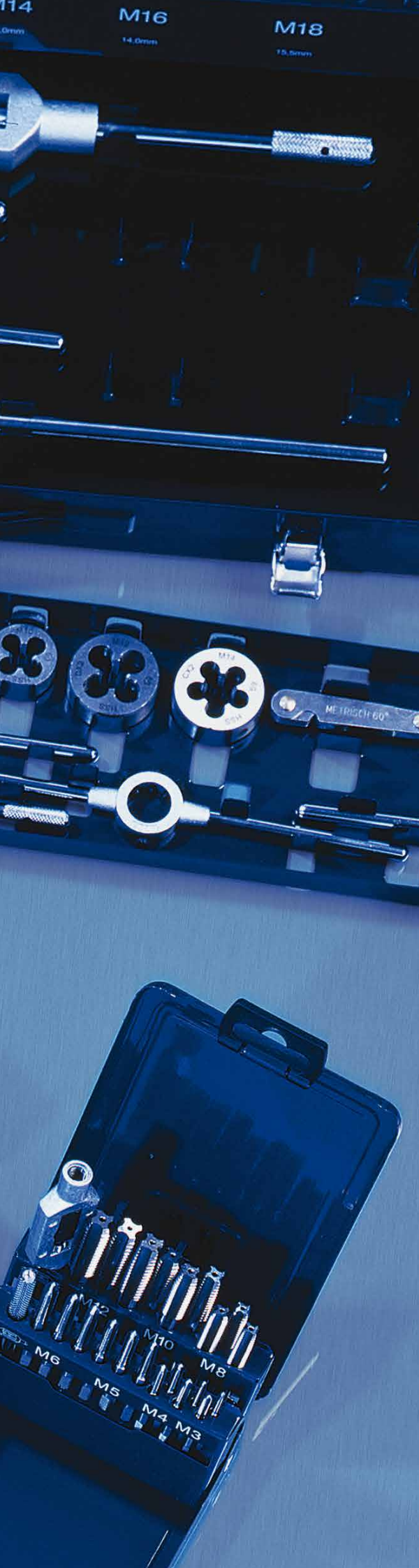

GEWINDESORTIMENTE

THREAD CUTTING

ASSORTMENTS

EVENTUS[®]
by EXACT

Handgewinde

Hand Taps

- metrisch **32-36**
- metrisch fein **38-39**
32-33

Maschinengewinde

Machine Taps

- metrisch **39**

Einschnittgewindebohrer

Short Machine Taps

- metrisch **37**

Schneideisen

Circular Dies

- metrisch **37**

Aktionsortimente

Promotion Sets

- Metallbearbeitung **38**
- Powerpacks **39**
- Gewindegewindesortiment **40-41**

M3 - M12

**STM
15**

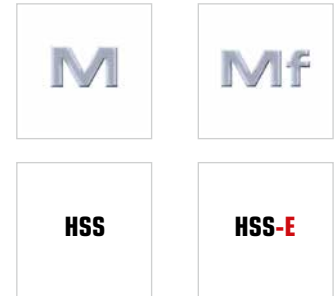

Technische Information

HSS = Hochleistungsschnell-Stahl
DIN 352 • Für metrisches ISO-Gewinde DIN 13, Toleranz 6H

Technical Information

HSS = High-speed-steel
DIN 352 • For metric ISO-thread DIN 13, tolerance 6H

Anwendung

Zum Schneiden von Innen- und Außengewinden.

Application

For cutting threads.

No.	M	M3 – M12	i	CODE	€ SET
STM 15S	metrisch	Gewindeschneidsortiment, 42-teilig Thread Cutting Assortment, 42 pieces Handgewindebohrer (Vor-, Mittel-, Fertigschneider) Hand Taps M3 - M4 - M5 - M6 - M8 - M10 - M12 + Schneideisen Circular Dies M3 - M4 - M5 - M6 - M8 - M10 - M12 + Schneideisenhalter Holder for Circular Dies 20x5 / 20x7 / 25x9 / 30x11 / 38x14 + Windeisen Tap wrenches 1 + 2 + Kernlochbohrer Twist Drills Ø 2,5 / 3,3 / 4,2 / 5,0 / 6,8 / 8,5 / 10,2	HSS	10731	
			HSS-E	10751	
STM 15SF	metrisch	Gewindeschneidsortiment, 49-teilig Thread Cutting Assortment, 49 pieces wie STM 15S + Führungen Guides Nr. 1 - 2 - 3 - 4 - 5 - 6 - 7	HSS	10721	
STM 15SW	metrisch	Gewindeschneidsortiment, 43-teilig Thread Cutting Assortment, 43 pieces wie STM 15S + Werkzeughalter Toolholder	HSS	10722	
			HSS-E	10753	

No.	Mf	M3 – M12	i	CODE	€ SET
STM 15S	metrisch fein	Gewindeschneidsortiment, 35-teilig Thread Cutting Assortment, 35 pieces Handgewindebohrer (Vor-, Fertigschneider) Hand Taps Mf3x0,35 - Mf4x0,5 - Mf5x0,5 - Mf6x0,75 - Mf8x1,0 - Mf10x1,0 - Mf12x1,5 + Schneideisen Circular Dies Mf3 - Mf4 - Mf5 - Mf6 - Mf8 - Mf10 - Mf12 + Schneideisenhalter Holder for Circular Dies 20x5 / 20x7 / 25x9 / 30x11 / 38x14 + Windeisen Tap wrenches 1 + 2	HSS	10741	
STM 15SF	metrisch fein	Gewindeschneidsortiment, 42-teilig Thread Cutting Assortment 42 pieces wie STM 15S + Führungen Guides Nr. 1 - 2 - 3 - 4 - 5 - 6 - 7	HSS	10742	
STM 15SW	metrisch fein	Gewindeschneidsortiment, 36-teilig Thread Cutting Assortment, 36 pieces wie STM 15S + Werkzeughalter Toolholder	HSS	10743	

STM
35

M3 - M20

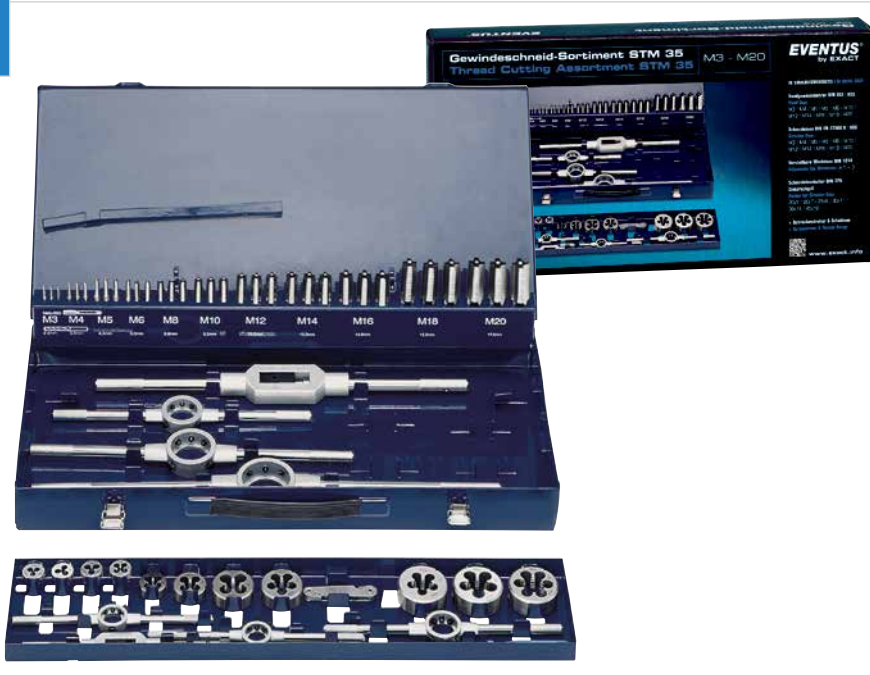

Sortimente • Assortments

Technische Information

HSS = Hochleistungsschnell-Stahl
DIN 352 • Für metrisches ISO-Gewinde DIN 13, Toleranz 6H

Technical Information

HSS = High-speed-steel
DIN 352 • For metric ISO-thread DIN 13, tolerance 6H

Anwendung

Zum Schneiden von Innen- und Außengewinden.

Application

For cutting threads.

No.	M	M3 – M20	i	CODE	€ SET
STM 35	metrisch	Gewindeschneidsortiment, 52-teilig Thread Cutting Assortment, 52 pieces Handgewindebohrer (Vor-, Mittel-, Fertigschneider) Hand Taps M3 - M4 - M5 - M6 - M8 - M10 - M12 - M14 - M16 - M18 - M20 + Schneideisen Circular Dies M3 - M4 - M5 - M6 - M8 - M10 - M12 - M14 - M16 - M18 - M20 + Schneideisenhalter Holder for Circular Dies 20x5 / 20x7 / 25x9 / 30x11 / 38x14 / 45x18 + Windeisen Tap wrenches 1 + 3	HSS	10723	
			HSS-E	10754	
STM 35F	metrisch	Gewindeschneidsortiment, 59-teilig Thread Cutting Assortment, 59 pieces wie STM 35S + Führungen Guides Nr. 1 - 2 - 3 - 4 - 5 - 6 - 7	HSS	10733	
			HSS-E	10755	

No.	Mf	M3 – M20	i	CODE	€ SET
STM 35	metrisch fein	Gewindeschneidsortiment, 41-teilig Thread Cutting Assortment, 41 pieces Handgewindebohrer (Vor-, Fertigschneider) Hand Taps Mf3x0,35 - Mf4x0,5 - Mf5x0,5 - Mf6x0,75 - Mf8x1,0 - Mf10x1,0 - Mf12x1,5 - Mf14x1,5 - Mf16x1,5 - Mf18x1,5 - Mf20x1,5 + Schneideisen Circular Dies Mf3 - Mf4 - Mf5 - Mf6 - Mf8 - Mf10 - Mf12 - Mf14 - Mf16 - Mf18 - Mf20 + Schneideisenhalter Holder for Circular Dies 20x5 / 20x7 / 25x9 / 30x11 / 38x14 / 45x18 + Windeisen Tap wrenches 1 + 3	HSS	10744	
			HSS	10745	
STM 35F	metrisch fein	Gewindeschneidsortiment, 48-teilig Thread Cutting Assortment 48 pieces wie STM 35S + Führungen Guides Nr. 1 - 2 - 3 - 4 - 5 - 6 - 7	HSS		

STM
55

M3 - M24



Technische Information

HSS = Hochleistungsschnell-Stahl
DIN 352 • Für metrisches ISO-Gewinde DIN 13, Toleranz 6H

Anwendung

Zum Schneiden von Gewinden.

Technical Information

HSS = High-speed-steel
DIN 352 • For metric ISO-thread DIN 13, tolerance 6H

Application

For cutting threads.

No.	M	M3 – M24	i	CODE	€ SET
STM 55	metrisch	Gewindeschneidsortiment, 62-teilig Thread Cutting Assortment, 62 pieces <ul style="list-style-type: none"> • Handgewindebohrer (Vor-, Mittel-, Fertigschneider) Hand Taps M3 - M4 - M5 - M6 - M8 - M10 - M12 - M14 - M16 - M18 - M20 - M22 - M24 • Schneideisen Circular Dies M3 - M4 - M5 - M6 - M8 - M10 - M12 - M14 - M16 - M18 - M20 - M22 - M24 + Schneideisenhalter Holder for Circular Dies 20x5 / 20x7 / 25x9 / 30x11 / 38x14 / 45x18 / 55x22 + Windeisen Tap wrenches 0 + 2 + 4 	HSS	10724	

Gewindeschneidsortiment DIN 352 Thread Cutting Assortments DIN 352

MA 5

M3 - M12



Abb. MA 5



Abb. MA 5 Spezial



Sortimente • Assortments

No.	M	M3 - M12	i	CODE	€ SET
MA 5	metrisch	Gewindeschneidsortiment, 21-teilig Thread Cutting Assortment, 21 pieces Handgewindebohrer (Vor-, Mittel-, Fertigschneider) Hand Taps M3 - M4 - M5 - M6 - M8 - M10 - M12	HSS	10701	
MA 5 / VW	metrisch	Gewindeschneidsortiment, 22-teilig Thread Cutting Assortment, 22 pieces wie MA 5 + Windeisen Tap Wrenches 1 1/2	HSS	10702	
MA 5 Spezial	metrisch	Gewindeschneidsortiment, 29-teilig Thread Cutting Assortment, 29 pieces wie MA 5 + Windeisen Tap wrench 1 1/2 + Kernlochbohrer Twist Drills \varnothing 2,5 / 3,3 / 4,2 / 5,0 / 6,8 / 8,5 / 10,2	HSS	10703	

CM 15

M3 - M12



No.	M	M3 - M12	i	CODE	€ SET
CM 15	metrisch	Gewindeschneidsortiment, 32-teilig Thread Cutting Assortment, 32 pieces • Handgewindebohrer (Vor-, Mittel-, Fertigschneider) Hand Taps M3 - M4 - M5 - M6 - M8 - M10 - M12 • Schneideisen (25x9) Circular Dies (25x9) M3 - M4 - M5 - M6 - M8 - M10 - M12 + Schneideisenhalter Holder for Circular Dies 25x9 + Windeisen Tap wrench 1 1/2 + Schraubendreher Screw driver + Gewindelehre Gauge	HSS	10711	

Einschnittgewindebohrer DIN 352

Short Machine Taps DIN 352

EVENTUS
by EXACT

Sortimente • Assortments

EB 3

M3 - M12



M

HSS

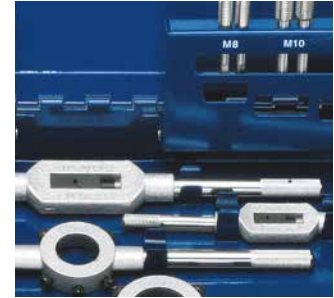

No.	M	M3 - M12	i	CODE	€ SET
EB 3	metrisch	Gewindeschneidsortiment, 42-teilig Thread Cutting Assortment, 42 pieces • Einschnittgewindebohrer Short Machine Taps Je 2 x: M3 - M4 - M5 - M6 - M8 - M10 - M12 + Schneideisen Circular Dies M3 - M4 - M5 - M6 - M8 - M10 - M12 + Schneideisenhalter Holder for Circular Dies 20x5 / 20x7 / 25x9 / 30x11 / 38x14 + Windeisen Tap wrenches 1 + 2 + Kernlochbohrer Twist Drills Ø 2,5 / 3,3 / 4,2 / 5,0 / 6,8 / 8,5 / 10,2 + Führungen Guides Nr. 1 - 2 - 3 - 4 - 5 - 6 - 7	HSS	20333	

EB 1

M3 - M12

M

HSS



EB 4

M3 - M12

M

HSS



No.	M3 - M12	CODE	€ SET	No.	M3 - M12	CODE	€ SET
EB 1	16-teilig 16 pieces Einschnittgewindebohrer Short Machine Taps Je 2 x: M3 - M4 - M5 - M6 - M8 - M10 - M12 + Windeisen Tap wrench 1 1/2 + Werkzeughalter Tool holder 1	20331		EB 4	15-teilig 15 pieces Einschnittgewindebohrer Short Machine Taps M3 - M4 - M5 - M6 - M8 - M10 - M12 + Windeisen Tap wrench 1 1/2 + Kernlochbohrer Twist Drills Ø 2,5 / 3,3 / 4,2 / 5,0 / 6,8 / 8,5 / 10,2	20334	

M3 - M12

M

HSS



Technische Information

Schneideisen liefern wir in vorgeschlitzter (geschlossener) Ausführung. Sie sind für den allgemeinen Einsatz, z.B. für Stähle bis 900 N/mm², geeignet. Für VA-Materialien verwenden Sie unsere Schneideisen aus HSS-E.

Toleranzen

2A

6g

Normale Gewindeverbindung

Technical Information

We can supply dies ready with slot (closed version). These are suitable for general use, e.g. in steel up to 900 N/mm². For VA materials, please use our dies made of HSS-E.

Tolerances

2A

6g

Thread with normal clearance

M3 - M12

CODE

€
SET

Schneideisen-Set, 8-teilig
Set of Circular Dies, 8 pieces

- Schneideisen | Circular Dies
M3 - M4 - M5 - M6 - M8 - M10 - M12 • Ø 25 mm
- + Schneideisenhalter | Holder for Circular Dies 25x9

70418

M3 - M10

M

HSS



M3 - M10

CODE

€
SET

Einschnittgewindebohrerbit-Set, 12-teilig
Short Machine Tap Bit Set, 12 pieces

- Einschnittgewindebohrerbits | Short Machine Tap Bits
M3 - M4 - M5 - M6 - M8 - M10
- + Spiralbohrer | Twist Drills
Ø 2,5 - 3,3 - 4,2 - 5,0 - 6,8 - 8,5 mm

70419

BLUE BOX



	CODE 	€ SET
<p>BLUE BOX 24-teilig 24 pieces</p> <p>1 Kegelsenker-Sortiment 6-teilig Countersink Assortment 6 pieces Ø 6,3 / 8,3 / 10,4 / 12,4 / 16,5 / 20,5 mm</p> <p>2 Stufenbohrersatz 3-teilig Step Drill Assortment 3 pieces Ø 4-12 / 4-20 / 6-30 mm</p> <p>3 Einschnittgewindebohrersatz 15-teilig Short Machine Tap Assortment 15 pieces M3 M4 M5 M6 M8 M10 M12 + Spiralbohrer Twist Drills Ø 2,5 / 3,3 / 4,2 / 5,0 / 6,8 / 8,5 / 10,2 + Inkl. verstellbarem Windeisen + Incl. adjustable Tap wrench</p>	70613	

Die Kompaktlösung für Senk-, Bohr- und Gewindearbeiten

- Senken + Entgraten
- Countersinking + deburring
- Bohren + Entgraten
- Drilling + deburring
- Schneiden von Innengewinden
- Cutting internal threads

M3 - M12



	CODE 	€ SET
<p>M3 - M12</p> <p>GEWINDEKOMPAKT, 21-teilig</p> <p>1 Einschnittgewindebohrerbit-Set 12-teilig Short Machine Tap Bit Set 12 pieces Einschnittgewindebohrerbits Short Machine Tap Bits M3 - M4 - M5 - M6 - M8 - M10 + Spiralbohrer Twist Drills Ø 2,5 / 3,3 / 4,2 / 5,0 / 6,8 / 8,5</p> <p>2 Schneideisen-Sortiment 8-teilig Circular Die Assortment 8 pieces Schneideisen Circular Dies DIN 223 Ø 25 mm: M3 - M4 - M5 - M6 - M8 - M10 - M12 + Schneideisenhalter Circular Die Guide 25 x 9</p> <p>Inkl. Schneidöl-spray Cutting spray 50 ml</p>	70603	



Die Kompaktlösung für Gewindearbeiten

- Schneiden von Innengewinden
- Cutting internal threads
- Schneiden von Außengewinden
- Cutting external threads

Handgewinde M3 - M12 | Hand Taps M3 - M12



M3 - M12	CODE	€ SET
22-teiliges Power Pack Power Pack 22 pieces: 1 Einschnittgewindebohrer-Sortiment 15-teilig Short Machine Tap Assortment 15 pieces Einschnittgewindebohrer Short Machine Taps M3 - M4 - M5 - M6 - M8 - M10 - M12 + Windeisen Tap wrench 1 1/2 + Kernlochbohrer Twist Drills Ø 2,5 / 3,3 / 4,2 / 5,0 / 6,8 / 8,5 / 10,2 2 Kegelsenker-Set 6-teilig Countersink Assotment 6 pieces Kegelsenker Countersinks DIN 335 C Ø 6,3 / 8,3 / 10,4 / 12,4 / 16,5 / 20,5 mm Inkl. Handbuch Gewindeschneiden	70601	



**INKLUSIVE
HANDBUCH
Gewindeschneiden**

Maschinengewinde M3 - M12 | Machine Taps M3 - M12



M3 - M12	CODE	€ SET
14-teiliges Power Pack Power Pack 14 pieces: 1 Maschinengewindebohrer-Sortiment 7-teilig Machine Tap Assortment 7 pieces Maschinengewindebohrer Machine Taps DIN 371/376 HSS I Form B M3 - M4 - M5 - M6 - M8 - M10 - M12 2 Kegelsenker-Set 6-teilig Countersink Assotment 6 pieces Kegelsenker Countersinks DIN 335 C Ø 6,3 / 8,3 / 10,4 / 12,4 / 16,5 / 20,5 mm Inkl. Handbuch Gewindeschneiden	70602	



**INKLUSIVE
HANDBUCH
Gewindeschneiden**

INNOVATION BY

EVENTUS[®]
by EXACT

PREMIUM-Gewindeschneidsortiment für Innen- und Außengewinde

Gewindeschneidsortiment | HSS | M3 - M12 | 52-teilig



Die innovative Kompaktlösung
für Ihre Gewindearbeiten.
The innovative compact solution
for threading work.



Vorteile | Advantages

- Optimiertes Werkzeugkonzept
- Innovatives Produktdesign
- Schaumstoffinlays herausnehmbar
- Koffer rutschsicher und stapelbar
- Optimised tool concept
- Innovative product design
- Removable inlays
- Case certainly about slide and stackable

GS
52

M3 - M12



**INKLUSIVE
HANDBUCH
Gewindeschneiden**



Sortimente • Assortments

Technische Information

HSS = Hochleistungsschnell-Stahl
DIN 352 • Für metrisches ISO-Gewinde DIN 13, Toleranz 6H

Technical Information

HSS = High-speed-steel
DIN 352 • For metric ISO-thread DIN 13, tolerance 6H

Anwendung

Zum Schneiden von Innen- und Außengewinden.

Application

For cutting threads.

Vorteile | Advantages



Koffer rutschsicher und stapelbar
Case certainly about slide and stackable



Schaumstoffinlays herausnehmbar
Removable inlays



Optimiertes Werkzeugkonzept
Optimised tool concept



No.	M	M3 - 12	i	CODE	€ SET
GS 52	metrisch	Gewindeschneidsortiment, 52-teilig Thread Cutting Assortment, 52 pieces <ul style="list-style-type: none"> • Handgewindebohrer (Vor-, Mittel-, Fertigschneider) Hand Taps M3 - M4 - M5 - M6 - M8 - M10 - M12 • Schneideisen DIN 223 Circular Dies M3 - M4 - M5 - M6 - M8 - M10 - M12 • Führung DIN 223 Guides M3 - M4 - M5 - M6 - M8 - M10 - M12 • Schneideisenhalter Holder for Circular Dies 20x5 20x7 25x9 30x11 38x14 • Verstellbare Windeisen Adjustable Tap Wrenches Gr. 1+2 • Kernlochbohrer DIN 338 HSS-G Twist Drills Ø 2,5 3,3 4,2 5,0 6,8 8,5 10,2 mm • Werkzeughalter Toolholder • Gewindelehre Gauge • Schraubendreher Screw Driver + Inklusive Handbuch Gewindeschneiden Included Threading Manual	HSS	70571	



HANDGEWINDE HAND TAPS

EXACT®

EVENTUS®
by EXACT

Handgewindebohrer

Hand Taps

■ metrisch	46-47	70-71
■ metrisch fein	49-53	73-74
■ BSW	56-57	
■ BSP (G)	59	76
■ UNC	61-62	
■ UNF	64-65	78
■ Trapez	67	

Schneideisen / Schneidmuttern

Circular Dies / Hexagon Die Nuts

■ metrisch	48	72
■ metrisch fein	54-55	72
■ BSW	58	
■ BSP (G)	60	75
■ UNC	63	77
■ UNF	66	79
■ Trapez	68	

Einschnittgewindebohrer

Short Machine Taps

■ metrisch	80	82
■ metrisch fein	81	83
■ NPT	81	
■ BSP (G)		83
■ UNC		84
■ UNF		84

Haltwerkzeuge

Guides/Toolholder

■ Schneideisenführungen	87	87
■ Schneideisenhalter	88 / 90	88 / 90
■ Windeisen	89 / 90	89 / 90
■ Werkzeughalter	92	92
■ Gewindebohrerverlängerung	93	93

Sortimente **19-29**

32-41

Assortments

Technische Information

Handgewindebohrer führen wir in allen gebräuchlichen Sorten und Abmessungen, profilgeschliffen und hinterschliffen, aus HSS und HSS-E, in verschiedenen Qualitätsstufen je nach Anforderung. Fragen Sie Sondergewinde an.

Toleranzen

2B **6H** Toleranz 2B / 6H = ISO2 Normale Gewindeverbindung

7H **6G** Toleranz 7H + 6G = ISO3 Gewindeverbindung mit Spiel

Technical Information

Hand Taps: we have all types and sizes in stock that are in general use, profile-ground and backed off, in HSS and HSS-E and in various different quality grades, as required. Please enquire if you need special threads.

Tolerances

2B **6H** Tolerance 2B / 6H = ISO2: Thread with normal clearance

7H **6G** Tolerance 7H + 6G = ISO3: Thread with large clearance

Anschnittlängen | Chamfer

metrisch | metric



metrisch fein | metric fine

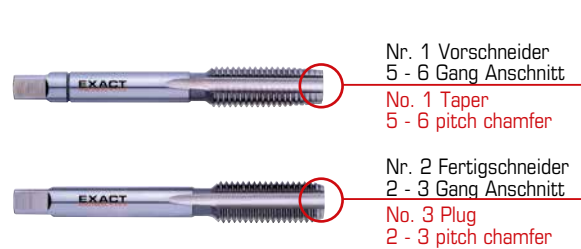

Ausführungen Handgewindebohrer | Versions of Hand Taps



M BSW UNC



M



M



Mf $\frac{G}{BSP}$ UNF



Mf



Tr



Tr



Technische Information

Schneideisen liefern wir in vorgeschlitzter (geschlossener) Ausführung. Sie sind für den allgemeinen Einsatz, z.B. für Stähle bis 900 N/mm², geeignet. Für VA-Materialien verwenden Sie unsere Schneideisen aus HSS-E.

Sechskant-Schneidmuttern nach DIN 382 dienen zum Nachschneiden von vorhandenen Gewinden. Es sind die gängigsten Sorten und Abmessungen lieferbar. Aufgrund der sechskantigen Ausführung erfolgt der Gebrauch durch Verwendung von Maul- und Ringschlüsseln.

Toleranzen

2A **6g** Normale Gewindeverbindung

Technical Information

We can supply Dies ready with slot (closed version). These are suitable for general use, e.g. in steel up to 900 N/mm². For VA materials, please use our dies made of HSS-E.

Hexagonal cutting nuts complying with DIN 382 can be used to repair or extend the tap on existing threads. All types and sizes in common use can be supplied. Because of the hexagonal design, these are used together with open-jaw and ring spanners.

Tolerances

2A **6g** Thread with normal clearance

Schneideisen | Circular Dies

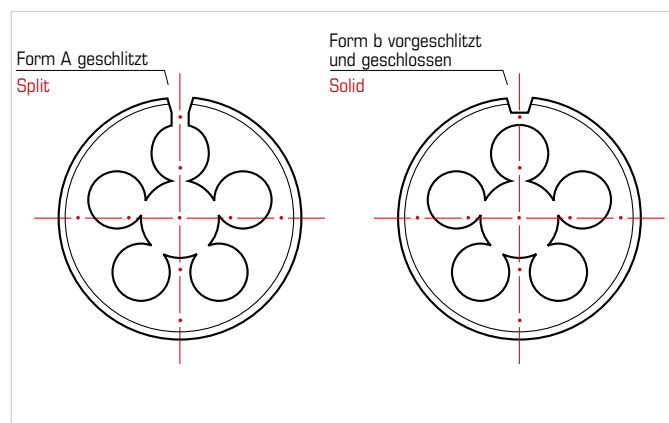
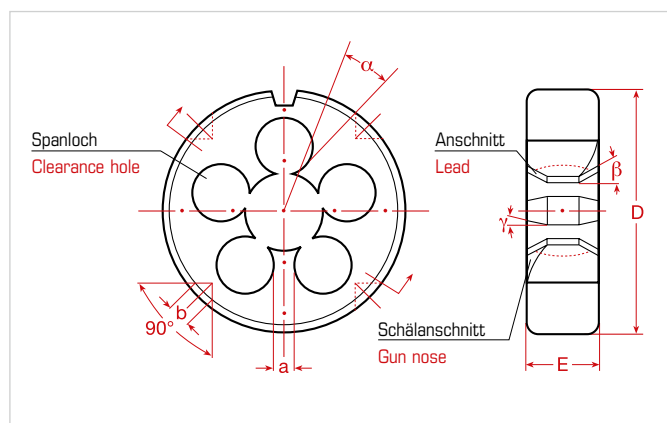

- D Außendurchmesser
- E Schneideisenhöhe
- a Stegbreite
- b Bohrung für Halteschrauben
- α Spanwinkel
- β Anschnittwinkel
- γ Schälanschnittwinkel

- D Outside diameter
- E Width of die
- a Width of land
- b Hole for holding screws
- α Rake angle
- β Lead angle
- γ Angle of gun nose

Ausführungen Schneideisen/-muttern | Versions of Circular Dies & Hexagon Die Nuts

HSS		HSS Links Left-hand		HSS-E		HSS	
M	Mf	M	Mf	M		M	Mf
BSW	G BSP	G BSP				BSW	G BSP
UNC	UNF						
Tr							

Schneideisen/-muttern | Circular Dies / Hexagon Die Nuts

Handgewindebohrer DIN 352

Hand Taps DIN 352

EXACT
PRÄZISIONSWERKZEUGE

Metrisch | Metric



Technische Information

HSS = Hochleistungsschnell-Stahl
 HSS-E = Hochleistungsschnell-Stahl Klasse E
 VA = Für VA-Materialien + rostfreie Stähle
 DIN 352 • Für metrisches ISO-Gewinde DIN 13, Toleranz 6H
 • M3-M12 in Werkzeugmacher-Ausführung,
 Vorschneider mit Führungszapfen

Technical Information

HSS = High-speed-steel
 HSS-E = High-speed-steel E-class
 VA = For VA materials + stainless steel
 DIN 352 • For metric ISO-thread DIN 13, tolerance 6H
 • M3 - M12 in tool-maker version,
 taper tap with guide journal

Anwendung

Zum Schneiden von Innengewinden für Durchgangs- und Sacklöcher.

Application

For cutting internal threads for through holes and blind holes.











M	mm	mm	mm	mm	mm	CODE	€	CODE	€	CODE	€
M 2,0	0,40	1,60	8	36	2,1	No. I	00029				
						No. II	00030				
						No. III	00031				
						Set	00032				
M 2,2	0,45	1,75	9	36	2,1	No. I	00033				
						No. II	00034				
						No. III	00035				
						Set	00036				
M 2,3	0,40	1,90	9	36	2,1	No. I	00037				
						No. II	00038				
						No. III	00039				
						Set	00040				
M 2,5	0,45	2,05	9	40	2,1	No. I	00041				
						No. II	00042				
						No. III	00043				
						Set	00044				
M 2,6	0,45	2,15	9	40	2,1	No. I	00045				
						No. II	00046				
						No. III	00047				
						Set	00048				
M 3,0	0,50	2,50	11	40	2,7	No. I	00049	No. I	00201	No. I	00301
						No. II	00050	No. II	00202	No. II	00302
						No. III	00051	No. III	00203	No. III	00303
						Set	00052	Set	00204	Set	00304
M 3,5	0,60	2,90	13	45	3,0	No. I	00053				
						No. II	00054				
						No. III	00055				
						Set	00056				
M 4,0	0,70	3,30	13	45	3,4	No. I	00057	No. I	00205	No. I	00305
						No. II	00058	No. II	00206	No. II	00306
						No. III	00059	No. III	00207	No. III	00307
						Set	00060	Set	00208	Set	00308
M 4,5	0,75	3,75	16	50	4,9	No. I	00061				
						No. II	00062				
						No. III	00063				
						Set	00064				
M 5,0	0,80	4,20	16	50	4,9	No. I	00065	No. I	00209	No. I	00309
						No. II	00066	No. II	00210	No. II	00310
						No. III	00067	No. III	00211	No. III	00311
						Set	00068	Set	00212	Set	00312
M 6,0	1,00	5,00	19	56	4,9	No. I	00069	No. I	00213	No. I	00313
						No. II	00070	No. II	00214	No. II	00314
						No. III	00071	No. III	00215	No. III	00315
						Set	00072	Set	00216	Set	00316



Handgewindebohrer DIN 352

Hand Taps DIN 352

Metrisch | Metric

M											
M 7,0	1,00	6,00	19	56	4,9	No. I	00073				
						No. II	00074				
						No. III	00075				
						Set	00076				
M 8,0	1,25	6,75	22	63	4,9	No. I	00077	No. I	00217	No. I	00317
						No. II	00078	No. II	00218	No. II	00318
						No. III	00079	No. III	00219	No. III	00319
						Set	00080	Set	00220	Set	00320
M 9,0	1,25	7,75	22	63	5,5	No. I	00081				
						No. II	00082				
						No. III	00083				
						Set	00084				
M 10,0	1,50	8,50	24	70	5,5	No. I	00085	No. I	00221	No. I	00321
						No. II	00086	No. II	00222	No. II	00322
						No. III	00087	No. III	00223	No. III	00323
						Set	00088	Set	00224	Set	00324
M 11,0	1,50	9,50	24	70	6,2	No. I	00089				
						No. II	00090				
						No. III	00091				
						Set	00092				
M 12,0	1,75	10,25	29	75	7,0	No. I	00093	No. I	00225	No. I	00325
						No. II	00094	No. II	00226	No. II	00326
						No. III	00095	No. III	00227	No. III	00327
						Set	00096	Set	00228	Set	00328
M 14,0	2,00	12,00	30	80	9,0	No. I	00097	No. I	00229	No. I	00329
						No. II	00098	No. II	00230	No. II	00330
						No. III	00099	No. III	00231	No. III	00331
						Set	00100	Set	00232	Set	00332
M 16,0	2,00	14,00	32	80	9,0	No. I	00101	No. I	00233	No. I	00333
						No. II	00102	No. II	00234	No. II	00334
						No. III	00103	No. III	00235	No. III	00335
						Set	00104	Set	00236	Set	00336
M 18,0	2,50	15,50	40	95	11,0	No. I	00105	No. I	00237	No. I	00337
						No. II	00106	No. II	00238	No. II	00338
						No. III	00107	No. III	00239	No. III	00339
						Set	00108	Set	00240	Set	00340
M 20,0	2,50	17,50	40	95	12,0	No. I	00109	No. I	00241	No. I	00341
						No. II	00110	No. II	00242	No. II	00342
						No. III	00111	No. III	00243	No. III	00343
						Set	00112	Set	00244	Set	00344
M 22,0	2,50	19,50	40	100	14,5	No. I	00113	No. I	00245		
						No. II	00114	No. II	00246		
						No. III	00115	No. III	00247		
						Set	00116	Set	00248		
M 24,0	3,00	21,00	50	110	14,5	No. I	00117	No. I	00249		
						No. II	00118	No. II	00250		
						No. III	00119	No. III	00251		
						Set	00120	Set	00252		
M 27,0	3,00	24,00	50	110	16,0	No. I	00121				
						No. II	00122				
						No. III	00123				
						Set	00124				
M 30,0	3,50	26,50	56	125	18,0	No. I	00125				
						No. II	00126				
						No. III	00127				
						Set	00128				
M 33,0	3,50	29,50	56	125	20,0	No. I	00129				
						No. II	00130				
						No. III	00131				
						Set	00132				
M 36,0	4,00	32,00	63	150	22,0	No. I	00133				
						No. II	00134				
						No. III	00135				
						Set	00136				

Handgewindebohrer | Hand Taps

Metrisch | Metric



Technische Information

HSS = Hochleistungsschnell-Stahl
 HSS-E = Hochleistungsschnell-Stahl Klasse E
 VA = Für VA-Materialien + rostfreie Stähle
 Schneideisen DIN 223 B = EN 22568 • Schneidmuttern DIN 382
 Für metrisches ISO-Gewinde DIN 13, Toleranz 6g

Technical Information

HSS = High-speed-steel
 HSS-E = High-speed-steel E-class
 VA = For VA materials + stainless steel
 Circular Dies DIN 223 B = EN 22568 • Hexagon Die Nuts DIN 382
 For metric ISO-thread DIN 13, tolerance 6g

Anwendung

Schneideisen zum Schneiden von Außengewinden – Schneidmuttern zum Nachschneiden vorhandener Gewinde.

Application

Circular Dies for cutting external threads – Hexagon Die Nuts can be used to repair or extend the tap on existing threads.

M	mm	mm	mm	CODE	€	CODE	€	CODE	€	mm	CODE	€
M 2,0	0,40	1,93	16 x 5	03708	11,95							
M 2,2	0,45	2,13	16 x 5	03709	11,78							
M 2,3	0,40	2,23	16 x 5	03710	11,78							
M 2,5	0,45	2,43	16 x 5	03711	11,63							
M 2,6	0,45	2,53	16 x 5	03712	11,63							
M 3,0	0,50	2,92	20 x 5	03713	10,08	03761		03801		19 x 5	04601	
M 3,5	0,60	3,41	20 x 5	03714	11,24					19 x 5	04602	
M 4,0	0,70	3,91	20 x 5	03715	10,08	03762		03802		19 x 5	04603	
M 4,5	0,75	4,41	20 x 7	03716	11,24					19 x 7	04604	
M 5,0	0,80	4,90	20 x 7	03717	10,11	03763		03803		19 x 7	04605	
M 6,0	1,00	5,88	20 x 7	03719	10,08	03764		03804		19 x 7	04606	
M 7,0	1,00	6,88	25 x 9	03720	11,38					22 x 9	04607	
M 8,0	1,25	7,87	25 x 9	03721	10,25	03765		03805		22 x 9	04608	
M 9,0	1,25	8,87	25 x 9	03722	11,95					22 x 9	04609	
M 10,0	1,50	9,85	30 x 11	03723	11,95	03766		03806		27 x 11	04610	
M 11,0	1,50	10,85	30 x 11	03724	17,00					27 x 11	04611	
M 12,0	1,75	11,83	38 x 14	03725	17,00	03767		03807		36 x 14	04612	
M 14,0	2,00	13,82	38 x 14	03726	17,64	03768		03808		36 x 14	04613	
M 16,0	2,00	15,82	45 x 18	03727	24,87	03769		03809		41 x 18	04614	
M 18,0	2,50	17,79	45 x 18	03728	25,27	03770		03810		41 x 18	04615	
M 20,0	2,50	19,79	45 x 18	03729	26,22	03771		03811		41 x 18	04616	
M 22,0	2,50	21,79	55 x 22	03730	36,47	03772				50 x 22	04617	
M 24,0	3,00	23,77	55 x 22	03731	40,98	03773				50 x 22	04618	
M 27,0	3,00	26,77	65 x 25	03732	51,47					60 x 25	04619	
M 30,0	3,50	29,73	65 x 25	03733	54,70					60 x 25	04620	
M 33,0	3,50	32,73	65 x 25	03734	56,69					60 x 25	04621	
M 36,0	4,00	35,70	65 x 25	03735	59,10					60 x 25	04622	

Weitere Abmessungen auf Anfrage lieferbar | Other sizes available on request



= Artikel für Kabelverschraubungen
 = Tools for cable connections

Handgewindebohrer DIN 2181

Hand Taps DIN 2181

Metrisch fein | Metric fine



Technische Information

HSS = Hochleistungsschnell-Stahl
DIN 2181 • Für metrisches ISO-Feingewinde DIN 13, Toleranz 6H

Technical Information

HSS = High-speed-steel
DIN 2181 • For metric ISO-fine thread DIN 13, tolerance 6H

Anwendung

Zum Schneiden von Innengewinden für Durchgangs- und Sacklöcher.
E Abmessungen für Kabelverschraubungen.

Application

For cutting internal threads for through holes and blind holes.
E For cable connections.

Mf	mm	mm	mm	mm	mm	CODE	€	CODE	€
Mf 3,0	0,35	2,65	9	40	2,7	No. I 00401 No. II 00402 Set 00403			
Mf 3,5	0,35	3,15	9	40	3,0	No. I 00404 No. II 00405 Set 00406			
Mf 4,0	0,35	3,65	10	45	3,4	No. I 00407 No. II 00408 Set 00409			
Mf 4,0	0,50	3,50	12	50	4,9	No. I 00410 No. II 00411 Set 00412			
Mf 5,0	0,50	4,50	12	50	4,9	No. I 00413 No. II 00414 Set 00415			
Mf 5,0	0,75	4,25	12	50	4,9	No. I 00416 No. II 00417 Set 00418			
Mf 6,0	0,50	5,50	14	50	4,9	No. I 00419 No. II 00420 Set 00421			
E Mf 6,0	0,75	5,35	14	50	4,9	No. I 00422 No. II 00423 Set 00424		No. I 00701 No. II 00702 Set 00703	
Mf 7,0	0,75	6,25	14	50	4,9	No. I 00425 No. II 00426 Set 00427			
Mf 8,0	0,50	7,50	19	50	4,9	No. I 00428 No. II 00429 Set 00430			
Mf 8,0	0,75	7,25	19	50	4,9	No. I 00431 No. II 00432 Set 00433		No. I 00704 No. II 00705 Set 00706	
E Mf 8,0	1,00	7,00	22	56	4,9	No. I 00434 No. II 00435 Set 00436		No. I 00707 No. II 00708 Set 00709	
Mf 9,0	0,75	8,25	19	56	5,5	No. I 00437 No. II 00438 Set 00439			
Mf 9,0	1,00	8,00	22	63	5,5	No. I 00440 No. II 00441 Set 00442			
Mf 10,0	0,75	9,25	20	63	5,5	No. I 00443 No. II 00444 Set 00445			



Handgewindebohrer DIN 2181

Hand Taps DIN 2181

EXACT
PRÄZISIONSWERKZEUGE

Metrisch fein | Metric fine

Fortsetzung

Continuation

Mf										
Mf 10,0	1,00	9,00	20	63	5,5	No. I	00446		No. I	00710
						No. II	00447		No. II	00711
						Set	00448		Set	00712
Mf 10,0	1,25	8,75	24	70	5,5	No. I	00449			
						No. II	00450			
						Set	00451			
Mf 11,0	1,00	10,00	20	63	6,2	No. I	00452			
						No. II	00453			
						Set	00454			
Mf 11,0	1,25	9,75	20	63	6,2	No. I	00455			
						No. II	00456			
						Set	00457			
Mf 12,0	0,75	11,25	22	63	7,0	No. I	00458			
						No. II	00459			
						Set	00460			
Mf 12,0	1,00	11,00	22	70	7,0	No. I	00461			
						No. II	00462			
						Set	00463			
Mf 12,0	1,25	10,75	22	70	7,0	No. I	00464			
						No. II	00465			
						Set	00466			
Mf 12,0	1,50	10,50	22	70	7,0	No. I	00467		No. I	00713
						No. II	00468		No. II	00714
						Set	00469		Set	00715
Mf 13,0	1,00	12,00	22	70	9,0	No. I	00470			
						No. II	00471			
						Set	00472			
Mf 13,0	1,50	11,50	22	70	9,0	No. I	00473			
						No. II	00474			
						Set	00475			
Mf 14,0	0,75	13,25	22	70	9,0	No. I	00476			
						No. II	00477			
						Set	00478			
Mf 14,0	1,00	13,00	22	70	9,0	No. I	00479			
						No. II	00480			
						Set	00481			
Mf 14,0	1,25	12,75	22	70	9,0	No. I	00482		No. I	00716
						No. II	00483		No. II	00717
						Set	00484		Set	00718
Mf 14,0	1,50	12,50	22	70	9,0	No. I	00485		No. I	00719
						No. II	00486		No. II	00720
						Set	00487		Set	00721
Mf 15,0	1,00	14,00	22	70	9,0	No. I	00488			
						No. II	00489			
						Set	00490			
Mf 15,0	1,50	13,50	22	70	9,0	No. I	00491			
						No. II	00492			
						Set	00493			
Mf 16,0	1,00	15,00	22	70	9,0	No. I	00494			
						No. II	00495			
						Set	00496			
Mf 16,0	1,25	14,75	22	70	9,0	No. I	00497			
						No. II	00498			
						Set	00499			
Mf 16,0	1,50	14,50	22	70	9,0	No. I	00500		No. I	00722
						No. II	00501		No. II	00723
						Set	00502		Set	00724
Mf 18,0	1,00	17,00	22	80	11,0	No. I	00503			
						No. II	00504			
						Set	00505			



Handgewindebohrer DIN 2181

Hand Taps DIN 2181

Metrisch fein | Metric fine

Fortsetzung

Continuation

Mf	mm	mm	mm	mm	mm	CODE	€	CODE	€
Mf 18,0	1,25	16,75	22	80	11,0	No. I 00506			
						No. II 00507			
						Set 00508			
Mf 18,0	1,50	16,50	22	80	11,0	No. I 00509		No. I 00725	
						No. II 00510		No. II 00726	
						Set 00511		Set 00727	
Mf 18,0	2,00	16,00	22	80	11,0	No. I 00512			
						No. II 00513			
						Set 00514			
Mf 20,0	1,00	19,00	22	80	12,0	No. I 00515			
						No. II 00516			
						Set 00517			
Mf 20,0	1,25	18,75	22	80	12,0	No. I 00518			
						No. II 00519			
						Set 00520			
F Mf 20,0	1,50	18,50	22	80	12,0	No. I 00521		No. I 00728	
F						No. II 00522		No. II 00729	
F						Set 00523		Set 00730	
Mf 20,0	2,00	18,00	22	80	12,0	No. I 00524			
						No. II 00525			
						Set 00526			
Mf 21,0	1,50	19,50	22	80	12,0	No. I 00527			
						No. II 00528			
						Set 00529			
Mf 22,0	1,00	21,00	22	80	14,5	No. I 00530			
						No. II 00531			
						Set 00532			
Mf 22,0	1,25	20,75	22	80	14,5	No. I 00533			
						No. II 00534			
						Set 00535			
Mf 22,0	1,50	20,50	22	80	14,5	No. I 00536		No. I 00731	
						No. II 00537		No. II 00732	
						Set 00538		Set 00733	
Mf 22,0	2,00	20,00	22	80	14,5	No. I 00539			
						No. II 00540			
						Set 00541			
Mf 23,0	1,50	21,50	22	80	14,5	No. I 00542			
						No. II 00543			
						Set 00544			
Mf 24,0	1,00	23,00	22	90	14,5	No. I 00545			
						No. II 00546			
						Set 00547			
Mf 24,0	1,25	22,75	22	90	14,5	No. I 00548			
						No. II 00549			
						Set 00550			
Mf 24,0	1,50	22,50	22	90	14,5	No. I 00551		No. I 00734	
						No. II 00552		No. II 00735	
						Set 00553		Set 00736	
Mf 24,0	2,00	22,00	22	90	14,5	No. I 00554			
						No. II 00555			
						Set 00556			
F Mf 25,0	1,50	23,50	22	90	14,5	No. I 00557			
F						No. II 00558			
F						Set 00559			
Mf 26,0	1,00	25,00	22	90	14,5	No. I 00560			
						No. II 00561			
						Set 00562			
Mf 26,0	1,50	24,50	22	90	14,5	No. I 00563			
						No. II 00564			
						Set 00565			



Handgewindebohrer DIN 2181

Hand Taps DIN 2181

EXACT
PRÄZISIONSWERKZEUGE

Metrisch fein | Metric fine

Fortsetzung

Continuation

Mf									
Mf 26,0	2,00	24,00	22	90	14,5	No. I 00566			
						No. II 00567			
						Set 00568			
Mf 27,0	1,50	25,50	22	90	16,0	No. I 00569			
						No. II 00570			
						Set 00571			
Mf 27,0	2,00	25,00	22	90	16,0	No. I 00572			
						No. II 00573			
						Set 00574			
Mf 28,0	1,00	27,00	22	90	16,0	No. I 00575			
						No. II 00576			
						Set 00577			
Mf 28,0	1,50	26,50	22	90	16,0	No. I 00578			
						No. II 00579			
						Set 00580			
Mf 28,0	2,00	26,00	22	90	16,0	No. I 00581			
						No. II 00582			
						Set 00583			
Mf 29,0	1,50	27,50	22	90	18,0	No. I 00584			
						No. II 00585			
						Set 00586			
Mf 30,0	1,00	29,00	22	90	18,0	No. I 00587			
						No. II 00588			
						Set 00589			
Mf 30,0	1,50	28,50	22	90	18,0	No. I 00590			
						No. II 00591			
						Set 00592			
Mf 30,0	2,00	28,00	22	90	18,0	No. I 00593			
						No. II 00594			
						Set 00595			
Mf 30,0	3,00	27,00	56	125	18,0	No. I 00596			
						No. II 00597			
						Set 00598			
Mf 32,0	1,50	30,50	22	90	18,0	No. I 00599			
						No. II 00600			
						Set 00601			
Mf 33,0	1,50	31,50	25	100	20,0	No. I 00602			
						No. II 00603			
						Set 00604			
Mf 33,0	2,00	31,00	25	100	20,0	No. I 00605			
						No. II 00606			
						Set 00607			
Mf 33,0	3,00	30,00	56	125	20,0	No. I 00608			
						No. II 00609			
						Set 00610			
Mf 34,0	1,50	32,50	25	100	22,0	No. I 00611			
						No. II 00612			
						Set 00613			
Mf 34,0	2,00	32,00	25	100	22,0	No. I 00614			
						No. II 00615			
						Set 00616			
Mf 35,0	1,50	33,50	25	100	22,0	No. I 00617			
						No. II 00618			
						Set 00619			
Mf 36,0	1,50	34,50	25	100	22,0	No. I 00620			
						No. II 00621			
						Set 00622			
Mf 36,0	2,00	34,00	25	100	22,0	No. I 00623			
						No. II 00624			
						Set 00625			



Handgewindebohrer DIN 2181

Hand Taps DIN 2181

Metrisch fein | Metric fine

Fortsetzung

Continuation

Mf	mm	mm	mm	mm	mm	CODE	€	CODE	€
Mf 36,0	3,00	33,00	40	125	22,0	No. I 00626			
						No. II 00627			
						Set 00628			
Mf 38,0	1,50	36,50	25	100	22,0	No. I 00629			
						No. II 00630			
						Set 00631			
Mf 39,0	1,50	37,50	25	110	24,0	No. I 00632			
						No. II 00633			
						Set 00634			
Mf 39,0	2,00	37,00	40	125	24,0	No. I 00635			
						No. II 00636			
						Set 00637			
Mf 39,0	3,00	36,00	40	125	24,0	No. I 00638			
						No. II 00639			
						Set 00640			
Mf 40,0	1,50	38,50	25	110	24,0	No. I 00641			
						No. II 00642			
						Set 00643			
Mf 40,0	2,00	38,00	40	125	24,0	No. I 00644			
						No. II 00645			
						Set 00646			
Mf 40,0	3,00	37,00	40	125	24,0	No. I 00647			
						No. II 00648			
						Set 00649			
Mf 50,0	1,50	48,50	25	125	29,0	No. I 00677			
						No. II 00678			
						Set 00679			
Mf 63,0	1,50	61,50	32	140	35,0	No. I 00689			
						No. II 00690			
						Set 00691			

Handgewindebohrer | Hand Taps

Weitere Abmessungen auf Anfrage lieferbar | Other sizes available on request



Handgewindesortimente metrisch fein: Seiten 27, 32, 33
Hand Tap Assortments metric fine: pages 27, 32, 33



Haltwerkzeuge: Seiten 88-92
Guides / Toolholder: pages 88-92

Metrisch fein | Metric fine

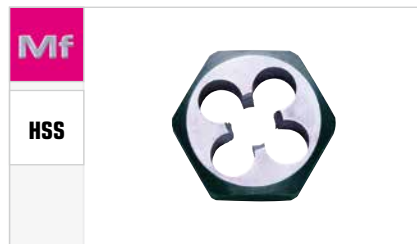
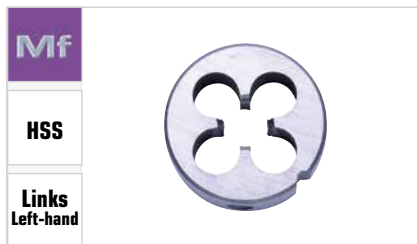
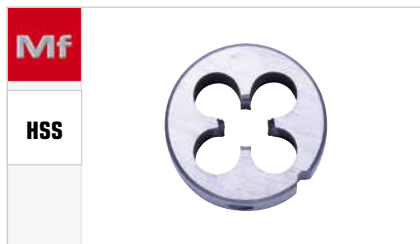

Technische Information

HSS = Hochleistungsschnell-Stahl
Schneideisen DIN 223 B = EN 22568 • Schneidmuttern DIN 382
Für metrisches ISO-Feingewinde DIN 13, Toleranz 6g

Anwendung

Schneideisen zum Schneiden von Außengewinden – Schneidmuttern zum Nachschneiden vorhandener Gewinde.
■ Abmessungen für Kabelverschraubungen.

Technical Information

HSS = High-speed-steel
Circular Dies DIN 223 B = EN 22568 • Hexagon Die Nuts DIN 382
For metric ISO-fine thread DIN 13, tolerance 6g

Application

Circular Dies for cutting external threads – Hexagon Die Nuts can be used to repair or extend the tap on existing threads.
■ For cable connections.

Mf	mm	mm	mm	CODE	€	CODE	€	mm	CODE	€
Mf 3,0	0,35	2,94	20 x 5	03901				19 x 5	04701	
Mf 3,5	0,35	3,44	20 x 5	03902						
Mf 4,0	0,35	3,94	20 x 5	03903						
Mf 4,0	0,50	3,93	20 x 5	03904				19 x 5	04702	
Mf 5,0	0,50	4,93	20 x 5	03905				19 x 5	04703	
Mf 5,0	0,75	4,90	20 x 7	03906						
Mf 6,0	0,50	5,93	20 x 5	03907						
■ Mf 6,0	0,75	5,90	20 x 7	03908		04021		19 x 5	04704	
Mf 7,0	0,75	6,90	25 x 9	03909				22 x 9	04705	
Mf 8,0	0,50	7,93	25 x 9	03910						
Mf 8,0	0,75	7,90	25 x 9	03911		04022		22 x 9	04706	
■ Mf 8,0	1,00	7,83	25 x 9	03912		04023		22 x 9	04707	
Mf 9,0	0,75	8,90	25 x 9	03913						
Mf 9,0	1,00	8,88	25 x 9	03914				22 x 9	04708	
Mf 10,0	0,75	9,93	30 x 11	03915						
■ Mf 10,0	1,00	9,88	30 x 11	03916		04024		27 x 11	04709	
Mf 10,0	1,25	9,86	30 x 11	03917						
Mf 11,0	1,00	10,88	30 x 11	03918				27 x 11	04710	
Mf 11,0	1,25	10,87	30 x 11	03919						
Mf 12,0	0,75	11,90	38 x 10	03920						
Mf 12,0	1,00	11,88	38 x 10	03921				36 x 10	04711	
Mf 12,0	1,25	11,86	38 x 10	03922				36 x 10	04712	
■ Mf 12,0	1,50	11,85	38 x 10	03923		04025		36 x 10	04713	
Mf 13,0	1,00	12,88	38 x 10	03924						
Mf 13,0	1,50	12,85	38 x 10	03925						
Mf 14,0	0,75	13,91	38 x 10	03926						
Mf 14,0	1,00	13,88	38 x 10	03927				36 x 10	04714	
Mf 14,0	1,25	13,86	38 x 10	03928				36 x 10	04715	
Mf 14,0	1,50	13,86	38 x 10	03929		04026		36 x 10	04716	
Mf 15,0	1,00	14,88	38 x 10	03930						
Mf 15,0	1,50	14,85	38 x 10	03931						
Mf 16,0	1,00	15,88	45 x 14	03932						
Mf 16,0	1,25	15,86	45 x 14	03933						
■ Mf 16,0	1,50	15,85	45 x 14	03934		04027		41 x 14	04717	
Mf 18,0	1,00	17,88	45 x 14	03935						
Mf 18,0	1,25	17,86	45 x 14	03936						
Mf 18,0	1,50	17,85	45 x 14	03937		04028		41 x 14	04718	
Mf 18,0	2,00	17,82	45 x 14	03938				41 x 14	04719	
Mf 20,0	1,00	19,88	45 x 14	03939						
Mf 20,0	1,25	19,86	45 x 14	03940						
■ Mf 20,0	1,50	19,85	45 x 14	03941		04029		41 x 14	04720	
Mf 20,0	2,00	19,82	45 x 14	03942				41 x 14	04721	
Mf 21,0	1,50	20,85	45 x 14	03943						
Mf 22,0	1,00	21,88	55 x 16	03944						



Metrisch fein | Metric fine

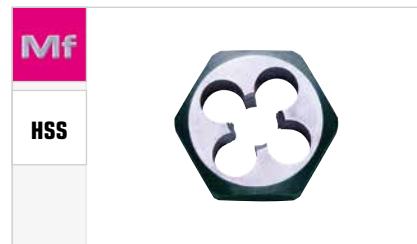
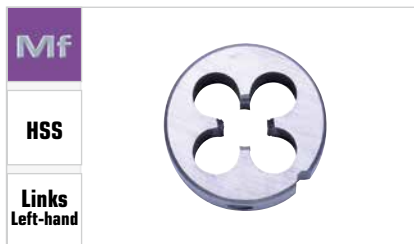
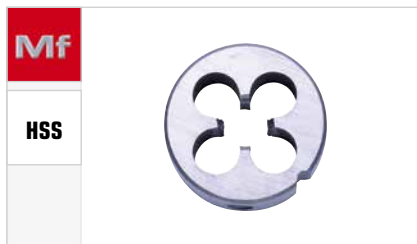

Fortsetzung

Continuation

Mf	mm	mm		CODE	€	CODE	€		CODE	€
Mf 22,0	1,25	21,85	55 x 16	03945						
Mf 22,0	1,50	21,85	55 x 16	03946		04030		50 x 16	04722	
Mf 22,0	2,00	21,82	55 x 16	03947				50 x 16	04723	
Mf 23,0	1,50	22,85	55 x 16	03948						
Mf 24,0	1,00	23,88	55 x 16	03949						
Mf 24,0	1,25	23,86	55 x 16	03950						
Mf 24,0	1,50	23,85	55 x 16	03951		04031		50 x 16	04724	
Mf 24,0	2,00	22,82	55 x 16	03952				50 x 16	04725	
F Mf 25,0	1,50	24,85	55 x 16	03953						
Mf 26,0	1,00	25,88	55 x 16	03954						
Mf 26,0	1,50	25,85	55 x 16	03955				60 x 18	04726	
Mf 26,0	2,00	25,82	55 x 16	03956						
Mf 27,0	1,50	26,85	65 x 18	03957				60 x 18	04727	
Mf 27,0	2,00	26,82	65 x 18	03958				60 x 18	04728	
Mf 28,0	1,00	27,88	65 x 18	03959						
Mf 28,0	1,50	27,85	65 x 18	03960				60 x 18	04729	
Mf 28,0	2,00	27,82	65 x 18	03961						
Mf 29,0	1,50	28,85	65 x 18	03962						
Mf 30,0	1,00	29,88	65 x 18	03963						
Mf 30,0	1,50	29,85	65 x 18	03964				60 x 18	04730	
Mf 30,0	2,00	29,82	65 x 18	03965				60 x 18	04731	
Mf 30,0	3,00	29,76	65 x 25	03966						
F Mf 32,0	1,50	31,85	65 x 18	03967				60 x 18	04732	
Mf 33,0	1,50	32,85	65 x 18	03968				60 x 18	04733	
Mf 33,0	2,00	32,82	65 x 18	03969				60 x 18	04734	
Mf 33,0	3,00	32,76	65 x 25	03970						
Mf 34,0	1,50	33,85	65 x 18	03971						
Mf 34,0	2,00	33,82	65 x 18	03972						
Mf 35,0	1,50	34,85	65 x 18	03973				60 x 18	04735	
Mf 36,0	1,50	35,85	65 x 18	03974				60 x 18	04736	
Mf 36,0	2,00	35,82	65 x 18	03975				60 x 18	04737	
Mf 36,0	3,00	35,76	65 x 25	03976				60 x 25	04738	
Mf 38,0	1,50	37,85	75 x 20	03977				70 x 20	04739	
Mf 39,0	1,50	38,85	75 x 20	03978				70 x 20	04740	
Mf 39,0	2,00	38,82	75 x 20	03979				70 x 20	04741	
Mf 39,0	3,00	38,76	75 x 20	03980				70 x 20	04742	
F Mf 40,0	1,50	39,85	75 x 20	03981				70 x 20	04743	
Mf 40,0	2,00	39,82	75 x 20	03982				70 x 20	04744	
Mf 40,0	3,00	39,76	75 x 20	03983						
F Mf 50,0	1,50	49,82	90 x 22	03993						
F Mf 63,0	1,50	62,85	105 x 22	03997						

Weitere Abmessungen auf Anfrage lieferbar | Other sizes available on request

Schneideisen/-muttern | Circular Dies / Hexagon Die Nuts



Handgewindebohrer DIN 2184

Hand Taps DIN 2184

EXACT
PRÄZISIONSWERKZEUGE

BSW Whitworth-Gewinde | BSW Whitworth thread



Technische Information

HSS = Hochleistungsschnell-Stahl
DIN 2184 • Für Whitworth Gewinde DIN 11

Anwendung

Zum Schneiden von Innengewinden für Durchgangs- und Sacklöcher.

Technical Information

HSS = High-speed-steel
DIN 2184 • For Whitworth thread DIN 11

Application

For cutting internal threads for through holes and blind holes.

BSW						CODE	€
1/16	60	1,20	10	32	2,1	No. I	00801
						No. II	00802
						No. III	00803
						Set	00804
3/32	48	1,90	11	36	2,1	No. I	00805
						No. II	00806
						No. III	00807
						Set	00808
1/8	40	2,60	12	40	2,7	No. I	00809
						No. II	00810
						No. III	00811
						Set	00812
5/32	32	3,20	14	45	3,4	No. I	00813
						No. II	00814
						No. III	00815
						Set	00816
3/16	24	3,80	14	45	4,3	No. I	00817
						No. II	00818
						No. III	00819
						Set	00820
7/32	24	4,60	18	50	4,9	No. I	00821
						No. II	00822
						No. III	00823
						Set	00824
1/4	20	5,10	22	56	4,9	No. I	00825
						No. II	00826
						No. III	00827
						Set	00828
5/16	18	6,50	22	56	4,9	No. I	00829
						No. II	00830
						No. III	00831
						Set	00832
3/8	16	7,90	25	70	5,5	No. I	00833
						No. II	00834
						No. III	00835
						Set	00836
7/16	14	9,30	30	75	6,2	No. I	00837
						No. II	00838
						No. III	00839
						Set	00840
1/2	12	10,50	30	75	7,0	No. I	00841
						No. II	00842
						No. III	00843
						Set	00844



Handgewindebohrer DIN 2184

Hand Taps DIN 2184

BSW Whitworth-Gewinde | BSW Whitworth thread



Fortsetzung

Continuation

BSW						CODE	€
9/16	12	12,00	32	80	9,0	No. I	00845
						No. II	00846
						No. III	00847
						Set	00848
5/8	11	13,50	32	80	9,0	No. I	00849
						No. II	00850
						No. III	00851
						Set	00852
3/4	10	16,50	40	95	11,0	No. I	00853
						No. II	00854
						No. III	00855
						Set	00856
7/8	9	19,50	40	100	14,5	No. I	00857
						No. II	00858
						No. III	00859
						Set	00860
1	8	22,00	50	110	16,0	No. I	00861
						No. II	00862
						No. III	00863
						Set	00864

Weitere Abmessungen auf Anfrage lieferbar | Other sizes available on request



Handgewindesortimente BSW: Seite 27
 Hand Tap Assortments BSW: page 27



Haltwerkzeuge: Seiten 88-92
 Guides / Toolholder: pages 88-92

BSW Whitworth-Gewinde | BSW Whitworth thread

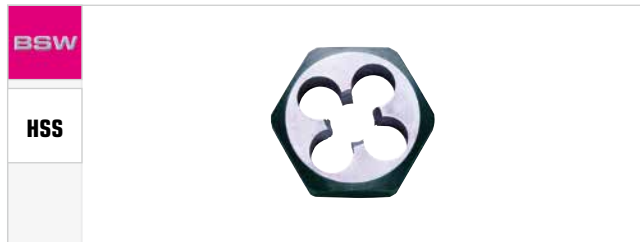

Technische Information

HSS = Hochleistungsschnell-Stahl
Schneideisen DIN 223 B = EN 22568 • Schneidmutter DIN 382
Für Whitworth Gewinde DIN 11

Anwendung

Schneideisen zum Schneiden von Außengewinden – Schneidmutter zum Nachschneiden vorhandener Gewinde.

Technical Information

HSS = High-speed-steel
Circular Dies DIN 223 B = EN 22568 • Hexagon Die Nuts DIN 382
For Whitworth thread DIN 11

Application

Circular Dies for cutting external threads – Hexagon Die Nuts can be used to repair or extend the tap on existing threads.

BSW	mm	mm	mm	CODE	€	mm	CODE	€
1/16	60	1,51	16 x 5	04101				
3/32	48	2,30	16 x 5	04102				
1/8	40	3,09	20 x 5	04103		19 x 5	04801	
5/32	32	3,88	20 x 5	04104				
3/16	24	4,66	20 x 7	04105		19 x 7	04802	
7/32	24	5,43	20 x 7	04106				
1/4	20	6,24	20 x 7	04107		19 x 7	04803	
5/16	18	7,82	25 x 9	04108		22 x 9	04804	
3/8	16	9,40	30 x 11	04109		27 x 11	04805	
7/16	14	10,98	30 x 11	04110		27 x 11	04806	
1/2	12	12,56	38 x 14	04111		36 x 14	04807	
9/16	12	14,14	38 x 14	04112		36 x 14	04808	
5/8	11	15,72	45 x 18	04113		41 x 18	04809	
3/4	10	18,89	45 x 18	04114		41 x 18	04810	
7/8	9	22,10	55 x 22	04115		50 x 22	04811	
1	8	25,27	55 x 22	04116		50 x 22	04812	

Weitere Abmessungen auf Anfrage lieferbar | Other sizes available on request

Handgewindebohrer DIN 5157

Hand Taps DIN 5157

BSP Whitworth-Rohrgewinde (G) | BSP Whitworth pipe thread (G)



Technische Information

HSS = Hochleistungsschnell-Stahl
DIN 5157
Für BSP Whitworth-Rohrgewinde (G) DIN 259 ISO 228 / Teil 1

Anwendung

Zum Schneiden von Innengewinden für Durchgangs- und Sacklöcher.

Technical Information

HSS = High-speed-steel
DIN 5157
For BSP Whitworth pipe thread DIN 259 ISO 228 / Part 1

Application

For cutting internal threads for through holes and blind holes.

G BSP	mm	mm	mm	mm	mm	CODE	€	CODE	€
1/8	28	8,80	20	63	5,5	No. I	01101	No. I	01201
						No. II	01102	No. II	01202
						Set	01103	Set	01203
1/4	19	11,80	20	70	9,0	No. I	01104	No. I	01204
						No. II	01105	No. II	01205
						Set	01106	Set	01206
3/8	19	15,30	22	70	9,0	No. I	01107	No. I	01207
						No. II	01108	No. II	01208
						Set	01109	Set	01209
1/2	14	19,00	22	80	12,0	No. I	01110	No. I	01210
						No. II	01111	No. II	01211
						Set	01112	Set	01212
5/8	14	21,00	22	80	14,5	No. I	01113	No. I	01213
						No. II	01114	No. II	01214
						Set	01115	Set	01215
3/4	14	24,50	22	90	16,0	No. I	01116	No. I	01216
						No. II	01117	No. II	01217
						Set	01118	Set	01218
7/8	14	28,25	22	90	18,0	No. I	01119	No. I	01219
						No. II	01120	No. II	01220
						Set	01121	Set	01221
1	11	30,50	25	100	20,0	No. I	01122	No. I	01222
						No. II	01123	No. II	01223
						Set	01124	Set	01224
1 1/8	11	35,50	40	125	22,0	No. I	01125	No. I	
						No. II	01126	No. II	
						Set	01127	Set	
1 1/4	11	39,50	40	125	24,0	No. I	01128	No. I	
						No. II	01129	No. II	
						Set	01130	Set	
1 3/8	11	42,00	40	125	29,0	No. I	01131	No. I	
						No. II	01132	No. II	
						Set	01133	Set	
1 1/2	11	45,00	40	140	29,0	No. I	01134	No. I	
						No. II	01135	No. II	
						Set	01136	Set	
1 3/4	11	51,00	40	140	32,0	No. I	01137	No. I	
						No. II	01138	No. II	
						Set	01139	Set	
2	11	57,00	40	160	35,0	No. I	01140	No. I	
						No. II	01141	No. II	
						Set	01142	Set	

Weitere Abmessungen auf Anfrage lieferbar | Other sizes available on request

BSP Whitworth-Rohrgewinde (G) | BSP Whitworth pipe thread (G)

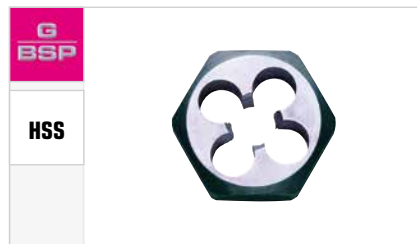
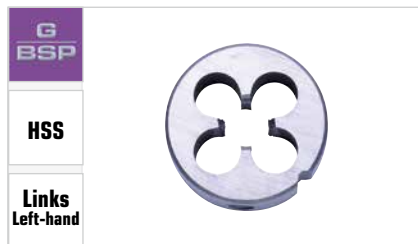
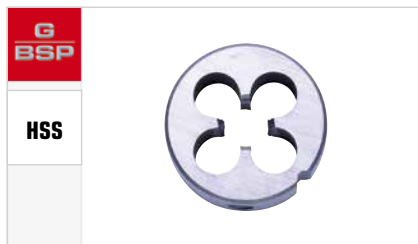

Technische Information

HSS = Hochleistungsschnell-Stahl
 Schneideisen DIN 5158 = EN 24231 • Schneidmutter DIN 382
 Für zylindrisches Whitworth-Rohrgewinde DIN 259 ISO 228 / Teil 1

Anwendung

Schneideisen zum Schneiden von Außengewinden – Schneidmuttern zum Nachschneiden vorhandener Gewinde.

Technical Information

HSS = High-speed-steel
 Circular Dies DIN 5158 = EN 24231 • Hexagon Die Nuts DIN 382
 For cylindrical Whitworth pipe thread DIN 259 ISO 228 / Part 1

Application

Circular Dies for cutting external threads – Hexagon Die Nuts can be used to repair or extend the tap on existing threads.

G BSP	mm	mm	mm	CODE	€	CODE	€	mm	CODE	€
1/8	28	9,62	30 x 11	04201		04231		27 x 11	04851	
1/4	19	13,03	38 x 10	04202		04232		36 x 10	04852	
3/8	19	16,53	45 x 14	04203		04233		41 x 14	04853	
1/2	14	20,81	45 x 14	04204		04234		41 x 14	04854	
5/8	14	22,77	55 x 16	04205		04235		50 x 16	04855	
3/4	14	26,30	55 x 16	04206		04236		50 x 16	04856	
7/8	14	30,06	65 x 18	04207		04237		60 x 18	04857	
1	11	33,07	65 x 18	04208		04238		60 x 18	04858	
1 1/8	11	37,71	75 x 20	04209				70 x 20	04859	
1 1/4	11	41,73	75 x 20	04210				70 x 20	04860	
1 3/8	11	44,14	90 x 22	04211				85 x 22	04861	
1 1/2	11	47,62	90 x 22	04212				85 x 22	04862	
1 3/4	11	53,56	90 x 22	04213				100 x 22	04863	
2	11	59,43	105 x 22	04214				100 x 22	04864	

Weitere Abmessungen auf Anfrage lieferbar | Other sizes available on request



Handgewindebohrer ≈ DIN 352

Hand Taps ≈ DIN 352

UNC | UNC



Technische Information

HSS = Hochleistungsschnell-Stahl
≈ DIN 352 • Für UNC-Gewinde (Unified-Grobgewinde), Toleranz 2B

Technical Information

HSS = High-speed-steel
≈ DIN 352 • For UNC thread (Unified coarse thread), tolerance 2B

Anwendung

Zum Schneiden von Innengewinden für Durchgangs- und Sacklöcher.

Application

For cutting internal threads for through holes and blind holes.

UNC						CODE	€
No. 4	40	2,30	10	40	2,7	No. I	01313
						No. II	01314
						No. III	01315
						Set	01316
No. 5	40	2,60	12	40	2,7	No. I	01317
						No. II	01318
						No. III	01319
						Set	01320
No. 6	32	2,80	14	45	3,0	No. I	01321
						No. II	01322
						No. III	01323
						Set	01324
No. 8	32	3,50	14	45	3,4	No. I	01325
						No. II	01326
						No. III	01327
						Set	01328
No. 10	24	3,90	16	48	4,9	No. I	01329
						No. II	01330
						No. III	01331
						Set	01332
No. 12	24	4,50	18	50	4,9	No. I	01333
						No. II	01334
						No. III	01335
						Set	01336
1/4	20	5,20	22	56	4,9	No. I	01337
						No. II	01338
						No. III	01339
						Set	01340
5/16	18	6,60	22	56	4,9	No. I	01341
						No. II	01342
						No. III	01343
						Set	01344
3/8	16	8,00	28	70	5,5	No. I	01345
						No. II	01346
						No. III	01347
						Set	01348
7/16	14	9,40	30	75	6,2	No. I	01349
						No. II	01350
						No. III	01351
						Set	01352
1/2	13	10,80	30	75	7,0	No. I	01353
						No. II	01354
						No. III	01355
						Set	01356



Handgewindebohrer ≈ DIN 352

Hand Taps ≈ DIN 352





EXACT
PRÄZISIONSWERKZEUGE

UNC | UNC



Fortsetzung

Continuation

UNC						CODE	€
9/16	12	12,30	32	80	9,0	No. I	01357
						No. II	01358
						No. III	01359
						Set	01360
5/8	11	13,50	32	80	9,0	No. I	01361
						No. II	01362
						No. III	01363
						Set	01364
3/4	10	16,50	40	95	11,0	No. I	01365
						No. II	01366
						No. III	01367
						Set	01368
7/8	9	19,50	40	100	14,5	No. I	01369
						No. II	01370
						No. III	01371
						Set	01372
1	8	22,30	50	110	16,0	No. I	01373
						No. II	01374
						No. III	01375
						Set	01376

Weitere Abmessungen auf Anfrage lieferbar | Other sizes available on request



Handgewindesortimente UNC: Seite 27
Hand Tap Assortments UNC: page 27



Haltwerkzeuge: Seiten 88-92
Guides / Toolholder: pages 88-92



Schneideisen DIN EN 22568

Circular Dies DIN EN 22568

UNC | UNC



Technische Information

HSS = Hochleistungsschnell-Stahl
DIN 223 B = EN 22568 • Für UNC-Gewinde (Unified-Grobgewinde),
Toleranz 2A

Anwendung

Schneideisen zum Schneiden von Außengewinden.

Technical Information

HSS = High-speed-steel
DIN 223 B = EN 22568 • For UNC thread (Unified coarse thread),
tolerance 2A

Application

Circular Dies for cutting external threads.

UNC	mm	mm	mm	CODE	€
No. 4	40	2,76	20 x 5	04304	
No. 5	40	3,09	20 x 5	04305	
No. 6	32	3,41	20 x 5	04306	
No. 8	32	4,07	20 x 5	04307	
No. 10	24	4,71	20 x 7	04308	
No. 12	24	5,37	20 x 7	04309	
1/4	20	6,22	20 x 7	04310	
5/16	18	7,80	25 x 9	04311	
3/8	16	9,37	30 x 11	04312	
7/16	14	10,95	30 x 11	04313	
1/2	13	12,52	38 x 14	04314	
9/16	12	14,10	38 x 14	04315	
5/8	11	15,68	45 x 18	04316	
3/4	10	18,84	45 x 18	04317	
7/8	9	22,00	55 x 22	04318	
1	8	25,16	55 x 22	04319	

Weitere Abmessungen auf Anfrage lieferbar | Other sizes available on request

Schneideisen | Circular Dies



Handgewindebohrer ≈ DIN 2181

Hand Taps ≈ DIN 2181

EXACT
PRÄZISIONSWERKZEUGE

UNF | UNF



Technische Information

HSS = Hochleistungsschnell-Stahl
≈ DIN 2181 • Für UNF-Gewinde (Unified-Feingewinde), Toleranz 2B

Anwendung

Zum Schneiden von Innengewinden für Durchgangs- und Sacklöcher.

Technical Information

HSS = High-speed-steel
≈ DIN 2181 • For UNF thread (Unified fine thread), tolerance 2B

Application

For cutting internal threads for through holes and blind holes.

UNF						CODE	€
No. 4	48	2,40	10	40	2,7	No. I	01513
						No. II	01514
						Set	01515
No. 5	44	2,70	12	40	2,7	No. I	01516
						No. II	01517
						Set	01518
No. 6	40	3,00	14	45	3,0	No. I	01519
						No. II	01520
						Set	01521
No. 8	36	3,50	14	45	3,4	No. I	01522
						No. II	01523
						Set	01524
No. 10	32	4,10	16	48	4,9	No. I	01525
						No. II	01526
						Set	01527
No. 12	28	4,65	16	50	4,9	No. I	01528
						No. II	01529
						Set	01530
1/4	28	5,50	16	50	4,9	No. I	01531
						No. II	01532
						Set	01533
5/16	24	6,90	16	56	4,9	No. I	01534
						No. II	01535
						Set	01536
3/8	24	8,50	16	56	5,5	No. I	01537
						No. II	01538
						Set	01539
7/16	20	9,90	18	63	6,2	No. I	01540
						No. II	01541
						Set	01542
1/2	20	11,50	20	70	7,0	No. I	01543
						No. II	01544
						Set	01545
9/16	18	13,00	22	70	9,0	No. I	01546
						No. II	01547
						Set	01548



Handgewindebohrer ≈ DIN 2181

Hand Taps ≈ DIN 2181

UNF | UNF



UNF

HSS

Fortsetzung

Continuation

Handgewindebohrer | Hand Taps

UNF						CODE	€
5/8	18	14,60	22	70	9,0	No. I 01549 No. II 01550 Set 01551	
3/4	16	17,50	22	80	11,0	No. I 01552 No. II 01553 Set 01554	
7/8	14	20,50	28	90	14,5	No. I 01555 No. II 01556 Set 01557	
1	14 (NS)	23,40	32	100	16,0	No. I 01558 No. II 01559 Set 01560	
1	12	23,50	32	100	16,0	No. I 01561 No. II 01562 Set 01563	

Weitere Abmessungen auf Anfrage lieferbar | Other sizes available on request



Handgewindesortimente UNF: Seite 27
 Hand Tap Assortments UNF: page 27



Haltwerkzeuge: Seiten 88-92
 Guides / Toolholder: pages 88-92



Schneideisen DIN EN 22568

Circular Dies DIN EN 22568

EXACT
PRÄZISIONSWERKZEUGE

UNF | UNF

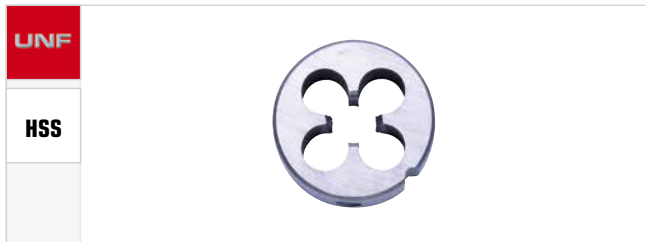

Technische Information

HSS = Hochleistungsschnell-Stahl • DIN 223 B = EN 22568
Für UNF-Gewinde (Unified-Feingewinde), Toleranz 2A

Technical Information

HSS = High-speed-steel • DIN 223 B = EN 22568
For UNF thread (Unified fine thread), tolerance 2A

Anwendung

Schneideisen zum Schneiden von Außengewinden.

Application

Circular Dies for cutting external threads.

UNF	mm	mm	mm	CODE	€
No. 4	48	2,77	20 x 5	04405	
No. 5	44	3,10	20 x 5	04406	
No. 6	40	3,42	20 x 5	04407	
No. 8	36	4,08	20 x 5	04408	
No. 10	32	4,73	20 x 7	04409	
No. 12	28	5,38	20 x 7	04410	
1/4	28	6,24	20 x 7	04411	
5/16	24	7,82	25 x 9	04412	
3/8	24	9,41	30 x 11	04413	
7/16	20	10,98	30 x 11	04414	
1/2	20	12,56	38 x 10	04415	
9/16	18	14,14	38 x 10	04416	
5/8	18	15,73	45 x 14	04417	
3/4	16	18,89	45 x 14	04418	
7/8	14	22,05	55 x 16	04419	
1	14 (NS)	25,16	55 x 16	04420	
1	12	25,21	55 x 16	04421	

Weitere Abmessungen auf Anfrage lieferbar | Other sizes available on request

Handgewindebohrer DIN 103

Hand Taps DIN 103

Trapez-Gewinde | Trapezoidal thread



Technische Information

HSS = Hochleistungsschnell-Stahl
DIN 103 • Für metrisches ISO-Trapez-Gewinde, Toleranz 7H

Technical Information

HSS = High-speed-steel
DIN 103 • For metric ISO trapezoidal thread, tolerance 7H

Anwendung

Zum Schneiden von Innengewinden für Durchgangs- und Sacklöcher.

Application

For cutting internal threads for through holes and blind holes.

Tr	mm	mm	mm	mm	mm	CODE	€
10	2	8,20	45	90	5,5	No. I 01705 No. II 01706 No. III 01707 Set 01708	
12	3	9,25	60	117	6,2	No. I 01709 No. II 01710 No. III 01711 Set 01712	
14	3	11,25	65	130	8,0	No. I 01713 No. II 01714 No. III 01715 Set 01716	
16	4	12,25	80	156	9,0	No. I 01717 No. II 01718 No. III 01719 Set 01720	
18	4	14,25	84	160	10,0	No. I 01721 No. II 01722 No. III 01723 Set 01724	
20	4	16,25	88	164	12,0	No. I 01725 No. II 01726 No. III 01727 Set 01728	
22	5	17,25	95	190	12,0	No. I 01729 No. II 01730 No. III 01731 Set 01732	
24	5	19,25	100	195	14,5	No. I 01733 No. II 01734 No. III 01735 Set 01736	
26	5	21,25	100	200	16,0	No. I 01737 No. II 01738 No. III 01739 Set 01740	
28	5	23,25	110	205	18,0	No. I 01741 No. II 01742 No. III 01743 Set 01744	
30	6	24,25	114	228	18,0	No. I 01745 No. II 01746 No. III 01747 Set 01748	
32	6	26,25	120	234	20,0	No. I 01749 No. II 01750 No. III 01751 Set 01752	



Schneideisen DIN EN 22568

Circular Dies DIN EN 22568

EXACT
PRÄZISIONSWERKZEUGE

Trapez-Gewinde | Trapezoidal thread



Technische Information

HSS = Hochleistungsschnell-Stahl
DIN 223 B = EN 22568 • Für Trapez-Gewinde nach DIN 103

Anwendung





Schneideisen zum Schneiden von Außengewinden.

Technical Information

HSS = High-speed-steel
DIN 223 B = EN 22568 • For trapezoidal thread in conformity with DIN 103

Application

Circular Dies for cutting external threads.

Tr				CODE 	€ 
10	2	9,91	38 x 14	04521	
10	3	9,88	38 x 14	04522	
12	3	11,88	38 x 14	04523	
14	3	13,88	45 x 18	04524	
14	4	13,65	45 x 18	04525	
16	4	15,85	45 x 18	04526	
18	4	17,85	45 x 18	04527	
20	4	19,85	55 x 22	04528	
22	5	21,83	55 x 22	04529	
24	5	23,83	65 x 25	04530	
26	5	25,83	65 x 25	04531	
28	5	27,83	65 x 25	04532	
30	6	29,81	65 x 25	04533	
32	6	31,81	65 x 25	04534	

Weitere Abmessungen auf Anfrage lieferbar | Other sizes available on request

Technische Information Handgewindebohrer
Handgewindebohrer führen wir im EVENTUS®-Programm in gebräuchlichen Sorten und Abmessungen, profilgeschliffen und hinterschliffen, aus HSS. Fragen Sie Sondergewinde an.

Toleranzen

2B **6H** Toleranz 2B / 6H = ISO2 Normale Gewindeverbindung

7H **6G** Toleranz 7H + 6G = ISO3 Gewindeverbindung mit Spiel

Technical Information Hand Taps

Hand Taps: we have a lot of types and sizes in stock that are in general use, profile-ground and backed off, in HSS. Please enquire if you need special threads.

Tolerances

2B **6H** Tolerance 2B / 6H = ISO2: Thread with normal clearance

7H **6G** Tolerance 7H + 6G = ISO3: Thread with large clearance

Anschnittlängen | Chamfer

metrisch | metric

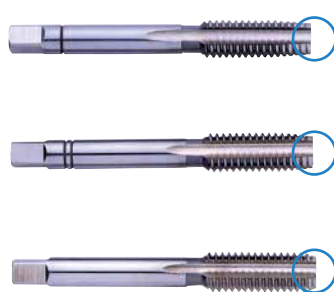

- Nr. 1 Vorschneider
6 - 8 Gang Anschnitt
No. 1 Taper
6 - 8 pitch chamfer
- Nr. 2 Mittelschneider
4 - 5 Gang Anschnitt
No. 2 Second
4 - 5 pitch chamfer
- Nr. 3 Fertigschneider
2 - 3 Gang Anschnitt
No. 3 Plug
2 - 3 pitch chamfer

metrisch fein | metric fine



- Nr. 1 Vorschneider
5 - 6 Gang Anschnitt
No. 1 Taper
5 - 6 pitch chamfer
- Nr. 2 Fertigschneider
2 - 3 Gang Anschnitt
No. 3 Plug
2 - 3 pitch chamfer

Ausführungen Handgewindebohrer | Versions of Hand Taps

HSS

M

UNC



HSS

Mf

**G
BSP**

UNF



Technische Information Schneideisen
Schneideisen liefern wir in vorgeschlitzter (geschlossener) Ausführung. Sie sind für den allgemeinen Einsatz, z.B. für Stähle bis 900 N/mm², geeignet. Für VA-Materialien verwenden Sie unsere Schneideisen aus HSS-E.

Toleranzen

2A **6g** Normale Gewindeverbindung

Technical Information Circular Dies
We can supply dies ready with slot (closed version). These are suitable for general use, e.g. in steel up to 900 N/mm². For VA materials, please use our dies made of HSS-E.

Tolerances

2A **6g** Thread with normal clearance

Ausführungen Schneideisen | Versions of Circular Dies

HSS

M

Mf

**G
BSP** **UNC** **UNF**





Handgewindebohrer DIN 352

Hand Taps DIN 352

EVENTUS
by EXACT

Metrisch | Metric



Technische Information

HSS = Hochleistungsschnell-Stahl
DIN 352 • Für metrisches ISO-Gewinde DIN 13, Toleranz 6H

Anwendung

Zum Schneiden von Innengewinden für Durchgangs- und Sacklöcher.

Technical Information

HSS = High-speed-steel
DIN 352 • For metric ISO-thread DIN 13, tolerance 6H

Application

For cutting internal threads for through holes and blind holes.

M						CODE	€
M 1,0	0,25	0,75	5,5	32	2,1	No. I	10061
						No. II	10062
						No. III	10063
M 1,1	0,25	0,75	5,5	32	2,1	Set	10064
						No. I	10065
						No. II	10066
M 1,2	0,25	0,95	5,5	32	2,1	No. III	10067
						Set	10068
						No. I	10069
M 1,4	0,30	1,10	7	32	2,1	No. II	10070
						No. III	10071
						Set	10072
M 1,6	0,35	1,25	8	32	2,1	No. I	10073
						No. II	10074
						No. III	10075
M 1,7	0,35	1,35	8	32	2,1	Set	10076
						No. I	10077
						No. II	10078
M 1,8	0,35	1,45	8	32	2,1	No. III	10079
						Set	10080
						No. I	10081
M 2,0	0,40	1,60	8	36	2,1	No. II	10082
						No. III	10083
						Set	10084
M 2,5	0,45	2,05	9	40	2,1	No. I	10085
						No. II	10086
						No. III	10087
M 3,0	0,50	2,50	11	40	2,7	Set	10088
						No. I	10089
						No. II	10090
M 4,0	0,70	3,30	13	45	3,4	No. III	10091
						Set	10092
						No. I	10093
						No. II	10094
						No. III	10095
						Set	10096
						No. I	10001
						No. II	10002
						No. III	10003
						Set	10004
						No. I	10005
						No. II	10006
						No. III	10007
						Set	10008

Handgewindebohrer DIN 352





Hand Taps DIN 352

EVENTUS[®]
by EXACT

Metrisch | Metric

Fortsetzung

Continuation

M						CODE	€
M 5,0	0,80	4,20	16	50	4,9	No. I	10009
						No. II	10010
						No. III	10011
						Set	10012
M 6,0	1,00	5,00	19	56	4,9	No. I	10013
						No. II	10014
						No. III	10015
						Set	10016
M 8,0	1,25	6,75	22	63	4,9	No. I	10017
						No. II	10018
						No. III	10019
						Set	10020
M 10,0	1,50	8,50	24	70	5,5	No. I	10021
						No. II	10022
						No. III	10023
						Set	10024
M 12,0	1,75	10,25	29	75	7,0	No. I	10025
						No. II	10026
						No. III	10027
						Set	10028
M 14,0	2,00	12,00	30	80	9,0	No. I	10029
						No. II	10030
						No. III	10031
						Set	10032
M 16,0	2,00	14,00	32	80	9,0	No. I	10033
						No. II	10034
						No. III	10035
						Set	10036
M 18,0	2,50	15,50	40	95	11,0	No. I	10037
						No. II	10038
						No. III	10039
						Set	10040
M 20,0	2,50	17,50	40	95	12,0	No. I	10041
						No. II	10042
						No. III	10043
						Set	10044
M 22,0	2,50	19,50	40	100	14,5	No. I	10045
						No. II	10046
						No. III	10047
						Set	10048
M 24,0	3,00	21,00	50	110	14,5	No. I	10049
						No. II	10050
						No. III	10051
						Set	10052
M 27,0	3,00	24,00	50	110	16,0	No. I	10053
						No. II	10054
						No. III	10055
						Set	10056
M 30,0	3,50	26,50	56	125	18,0	No. I	10057
						No. II	10058
						No. III	10059
						Set	10060

Weitere Abmessungen auf Anfrage lieferbar | Other sizes available on request



Schneideisen DIN EN 22568 Circular Dies DIN EN 22568

EVENTUS[®]
by EXACT

Metrisch | Metric



Technische Information

HSS = Hochleistungsschnell-Stahl
DIN 223 B • Für metrisches ISO-Gewinde DIN 13, Toleranz 6g

Technical Information



HSS = High-speed-steel
DIN 223 B • For metric ISO-thread DIN 13, tolerance 6g

Anwendung



Schneideisen zum Schneiden von Außengewinden.

Application

Circular Dies for cutting external threads.

M				CODE	€
M 1,0	0,25	0,97	16 / 5	10416	
M 1,1	0,25	1,07	16 / 5	10417	
M 1,2	0,25	1,17	16 / 5	10418	
M 1,4	0,30	1,36	16 / 5	10419	
M 1,6	0,35	1,54	16 / 5	10420	
M 1,7	0,35	1,64	16 / 5	10421	
M 1,8	0,35	1,74	16 / 5	10422	
M 2,0	0,40	1,93	16 / 5	10423	
M 2,5	0,45	2,43	16 / 5	10424	
M 3,0	0,50	2,92	20 / 5	10401	
M 4,0	0,70	3,91	20 / 5	10402	
M 5,0	0,80	4,90	20 / 7	10403	
M 6,0	1,00	5,88	20 / 7	10404	
M 8,0	1,25	7,87	25 / 9	10405	
M 10,0	1,50	9,85	30 / 11	10406	
M 12,0	1,75	11,83	38 / 14	10407	
M 14,0	2,00	13,82	38 / 14	10408	
M 16,0	2,00	15,82	45 / 18	10409	
M 18,0	2,50	17,79	45 / 18	10410	
M 20,0	2,50	19,79	45 / 18	10411	
M 22,0	2,50	21,79	55 / 22	10412	
M 24,0	3,00	23,77	55 / 22	10413	
M 27,0	3,00	26,77	65 / 25	10414	
M 30,0	3,50	29,73	65 / 25	10415	

Metrisch fein | Metric fine

Mf				CODE	€
Mf 3,0	0,35	2,94	20 / 5	10514	
Mf 4,0	0,35	3,94	20 / 5	10515	
Mf 5,0	0,50	4,93	20 / 5	10516	
Mf 6,0	0,75	5,90	20 / 7	10501	
Mf 8,0	0,75	7,90	25 / 9	10502	
Mf 8,0	1,00	7,83	25 / 9	10503	
Mf 10,0	1,00	9,88	30 / 11	10504	
Mf 12,0	1,00	11,88	38 / 10	10505	
Mf 12,0	1,50	11,85	38 / 10	10506	
Mf 14,0	1,25	13,86	38 / 10	10507	
Mf 14,0	1,50	13,85	38 / 10	10508	
Mf 16,0	1,50	15,85	45 / 14	10509	
Mf 18,0	1,50	17,85	45 / 14	10510	
Mf 20,0	1,50	19,85	45 / 14	10511	
Mf 22,0	1,50	21,85	55 / 16	10512	
Mf 24,0	1,50	23,85	55 / 16	10513	

Weitere Abmessungen auf Anfrage lieferbar | Other sizes available on request

Handgewindebohrer DIN 2181

Hand Taps DIN 2181

Metrisch fein | Metric fine



Technische Information

HSS = Hochleistungsschnell-Stahl
DIN 2181 • Für metrisches ISO-Feingewinde DIN 13, Toleranz 6H

Technical Information

HSS = High-speed-steel
DIN 2181 • For metric ISO-fine thread DIN 13, tolerance 6H

Anwendung

Zum Schneiden von Innengewinden für Durchgangs- und Sacklöcher.

Application

For cutting internal threads for through holes and blind holes.

Mf						CODE	€
Mf 3,0	0,35	2,65	9	40	2,7	No. I 10146 No. II 10147 Set 10148	
Mf 4,0	0,35	3,65	10	45	3,4	No. I 10149 No. II 10150 Set 10151	
Mf 5,0	0,50	4,50	12	50	4,9	No. I 10152 No. II 10153 Set 10154	
Mf 6,0	0,75	5,25	14	50	4,9	No. I 10101 No. II 10102 Set 10103	
Mf 8,0	0,75	7,25	19	50	4,9	No. I 10104 No. II 10105 Set 10106	
Mf 8,0	1,00	7,00	22	56	4,9	No. I 10107 No. II 10108 Set 10109	
Mf 10,0	1,00	9,00	20	63	5,5	No. I 10110 No. II 10111 Set 10112	
Mf 12,0	1,00	11,00	22	70	7,0	No. I 10113 No. II 10114 Set 10115	
Mf 12,0	1,50	10,50	22	70	7,0	No. I 10116 No. II 10117 Set 10118	
Mf 14,0	1,25	12,75	22	70	9,0	No. I 10119 No. II 10120 Set 10121	
Mf 14,0	1,50	12,50	22	70	9,0	No. I 10122 No. II 10123 Set 10124	
Mf 16,0	1,50	14,50	22	70	9,0	No. I 10125 No. II 10126 Set 10127	
Mf 18,0	1,50	16,50	22	80	11,0	No. I 10128 No. II 10129 Set 10130	
Mf 20,0	1,50	18,50	22	80	12,0	No. I 10131 No. II 10132 Set 10133	
Mf 22,0	1,50	20,50	22	80	14,5	No. I 10134 No. II 10135 Set 10136	
Mf 24,0	1,50	22,50	22	90	14,5	No. I 10137 No. II 10138 Set 10139	

Weitere Abmessungen auf Anfrage lieferbar | Other sizes available on request



Handgewindebohrer DIN 5157

Hand Taps DIN 5157

EVENTUS
by EXACT

BSP Whitworth-Rohrgewinde (G) | BSP Whitworth pipe thread (G)

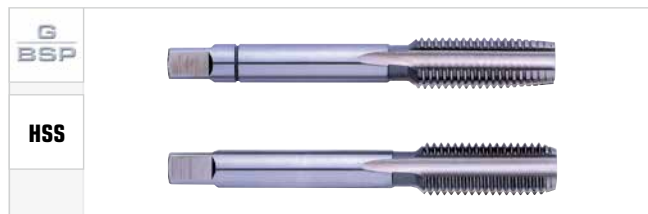

Technische Information

HSS = Hochleistungsschnell-Stahl
DIN 5157
Für BSP Whitworth-Rohrgewinde (G) DIN 259 ISO 228 / Teil 1

Anwendung

Zum Schneiden von Innengewinden für Durchgangs- und Sacklöcher.

Technical Information

HSS = High-speed-steel
DIN 5157
For BSP Whitworth pipe thread DIN 259 ISO 228 / Part 1

Application

For cutting internal threads for through holes and blind holes.

1/8	28	8,80	20	63	5,5	No. I	10201
						No. II	10202
						Set	10203
1/4	19	11,80	20	70	9,0	No. I	10204
						No. II	10205
						Set	10206
3/8	19	15,30	22	70	9,0	No. I	10207
						No. II	10208
						Set	10209
1/2	14	19,00	22	80	12,0	No. I	10210
						No. II	10211
						Set	10212
3/4	14	24,50	22	90	16,0	No. I	10213
						No. II	10214
						Set	10215
1	11	30,50	25	100	20,0	No. I	10216
						No. II	10217
						Set	10218

Weitere Abmessungen auf Anfrage lieferbar | Other sizes available on request



Schneideisen DIN 5158

Circular Dies DIN 5158

BSP Whitworth-Rohrgewinde (G) | BSP Whitworth pipe thread (G)



Technische Information

HSS = Hochleistungsschnell-Stahl
DIN 5158 • Für zylindrisches Whitworth-Rohrgewinde DIN 259
ISO 228 / Teil 1

Anwendung







Schneideisen zum Schneiden von Außengewinden.

Technical Information

HSS = High-speed-steel
DIN 5158 • For cylindrical Whitworth pipe thread DIN 259
ISO 228 / Part 1

Application

Circular Dies for cutting external threads.

					
1/8	28	9,62	30 / 11	10601	
1/4	19	13,03	38 / 10	10602	
3/8	19	16,53	45 / 14	10603	
1/2	14	20,81	45 / 14	10604	
3/4	14	26,30	55 / 16	10605	
1	11	33,07	65 / 18	10606	

Handgewindebohrer DIN 352

Hand Taps DIN 352

EVENTUS[®]
by EXACT

UNC | UNC



Technische Information

HSS = Hochleistungsschnell-Stahl

≈ DIN 352 • Für UNC-Gewinde (Unified-Grobgewinde), Toleranz 2B

Anwendung

Zum Schneiden von Innengewinden für Durchgangs- und Sacklöcher.

Technical Information

HSS = High-speed-steel

≈ DIN 352 • For UNC thread (Unified coarse thread), tolerance 2B

Application

For cutting internal threads for through holes and blind holes.

UNC	mm	mm	mm	mm	mm	CODE	€
No. 4	40	2,30	10	40	2,7	No. I	10220
						No. II	10221
						No. III	10222
						Set	10223
No. 5	40	2,60	12	40	2,7	No. I	10224
						No. II	10225
						No. III	10226
						Set	10227
No. 6	32	2,80	14	45	3,0	No. I	10228
						No. II	10229
						No. III	10230
						Set	10231
No. 8	32	3,50	14	45	3,4	No. I	10232
						No. II	10233
						No. III	10234
						Set	10235
No. 10	24	3,90	16	48	4,9	No. I	10236
						No. II	10237
						No. III	10238
						Set	10239
No. 12	24	4,50	18	50	4,9	No. I	10240
						No. II	10241
						No. III	10242
						Set	10243
1/4	20	5,20	22	56	4,9	No. I	10244
						No. II	10245
						No. III	10246
						Set	10247
5/16	18	6,60	22	56	4,9	No. I	10248
						No. II	10249
						No. III	10250
						Set	10251
7/16	14	9,40	30	75	6,2	No. I	10252
						No. II	10253
						No. III	10254
						Set	10255
1/2	13	10,80	30	75	7,0	No. I	10256
						No. II	10257
						No. III	10258
						Set	10259
9/16	12	12,30	32	80	9,0	No. I	10260
						No. II	10261
						No. III	10262
						Set	10263
5/8	11	13,50	32	80	9,0	No. I	10264
						No. II	10265
						No. III	10266
						Set	10267



Schneideisen DIN EN 22568 Circular Dies DIN EN 22568

UNC | UNC

Fortsetzung Handgewindebohrer UNC

Continuation Hand Taps UNC

UNC	mm	mm	mm	mm	mm	CODE	€
3/4	10	16,50	40	95	11,0	No. I	10268
						No. II	10269
						No. III	10270
						Set	10271
7/8	9	19,50	40	100	14,5	No. I	10272
						No. II	10273
						No. III	10274
						Set	10275
1	8	22,30	50	110	16,0	No. I	10276
						No. II	10277
						No. III	10278
						Set	10279

Weitere Abmessungen auf Anfrage lieferbar | Other sizes available on request

UNC | UNC



Technische Information

HSS = Hochleistungsschnell-Stahl
DIN 223 B = EN 22568 • Für UNC-Gewinde (Unified-Grobgewinde),
Toleranz 2A

Anwendung

Schneideisen zum Schneiden von Außengewinden.

Technical Information

HSS = High-speed-steel
DIN 223 B = EN 22568 • For UNC thread (Unified coarse thread),
tolerance 2A

Application

Circular Dies for cutting external threads.

UNC	mm	mm	mm	CODE	€
No. 4	40	2,76	20 x 5	10280	
No. 5	40	3,09	20 x 5	10281	
No. 6	32	3,41	20 x 5	10282	
No. 8	32	4,07	20 x 5	10283	
No. 10	24	4,71	20 x 7	10284	
No. 12	24	5,37	20 x 7	10285	
1/4	20	6,22	20 x 7	10286	
5/16	18	7,80	25 x 9	10287	
3/8	16	9,37	30 x 11	10288	
7/16	14	10,95	30 x 11	10289	
1/2	13	12,52	38 x 14	10290	
9/16	12	14,10	38 x 14	10291	
5/8	11	15,68	45 x 18	10292	
3/4	10	18,84	45 x 18	10293	
7/8	9	22,00	55 x 22	10294	
1	8	25,16	55 x 22	10295	

Weitere Abmessungen auf Anfrage lieferbar | Other sizes available on request



Handgewindebohrer DIN 2181

Hand Taps DIN 2181

UNF | UNF



Technische Information

HSS = Hochleistungsschnell-Stahl
≈ DIN 2181 • Für UNF-Gewinde (Unified-Feingewinde), Toleranz 2B

Anwendung

Zum Schneiden von Innengewinden für Durchgangs- und Sacklöcher.

Technical Information

HSS = High-speed-steel
≈ DIN 2181 • For UNF thread (Unified fine thread), tolerance 2B

Application

For cutting internal threads for through holes and blind holes.

UNF	mm	mm	mm	mm	mm	CODE	€
No. 4	48	2,40	10	40	2,7	No. I 10610 No. II 10611 Set 10612	
No. 5	44	2,70	12	40	2,7	No. I 10613 No. II 10614 Set 10615	
No. 6	40	3,00	14	45	3,0	No. I 10616 No. II 10617 Set 10618	
No. 8	36	3,50	14	45	3,4	No. I 10619 No. II 10620 Set 10621	
No. 10	32	4,10	16	48	4,9	No. I 10622 No. II 10623 Set 10624	
No. 12	28	4,65	16	50	4,9	No. I 10625 No. II 10626 Set 10627	
1/4	28	5,50	16	50	4,9	No. I 10628 No. II 10629 Set 10630	
5/16	24	6,90	16	56	4,9	No. I 10631 No. II 10632 Set 10633	
3/8	24	8,50	16	56	5,5	No. I 10634 No. II 10635 Set 10636	
7/16	20	9,90	18	63	6,2	No. I 10637 No. II 10638 Set 10639	
1/2	20	11,50	20	70	7,0	No. I 10640 No. II 10641 Set 10642	
9/16	18	13,00	22	70	9,0	No. I 10643 No. II 10644 Set 10645	
5/8	18	14,60	22	70	9,0	No. I 10646 No. II 10647 Set 10648	
3/4	16	17,50	22	80	11,0	No. I 10649 No. II 10650 Set 10652	
7/8	14	20,50	28	90	14,50	No. I 10653 No. II 10654 Set 10655	







Schneideisen DIN EN 22568 Circular Dies DIN EN 22568

UNF | UNF

Fortsetzung Handgewindebohrer UNF

Continuation Hand Taps UNF

UNF						CODE	€
1	14 (NS)	23,40	32	100	16,0	No. I 10656 No. II 10657 Set 10658	
1	12	23,50	32	100	16,0	No. I 10659 No. II 10660 Set 10661	

Weitere Abmessungen auf Anfrage lieferbar | Other sizes available on request

UNF | UNF



Technische Information

HSS = Hochleistungsschnell-Stahl • DIN 223 B = EN 22568
Für UNF-Gewinde (Unified-Feingewinde), Toleranz 2A

Technical Information



HSS = High-speed-steel • DIN 223 B = EN 22568
For UNF thread (Unified fine thread), tolerance 2A

Anwendung

Schneideisen zum Schneiden von Außengewinden.

Application

Circular Dies for cutting external threads.

UNF				CODE	€
No. 4	48	2,77	20 x 5	10680	
No. 5	44	3,10	20 x 5	10681	
No. 6	40	3,42	20 x 5	10682	
No. 8	36	4,08	20 x 5	10683	
No. 10	32	4,73	20 x 7	10684	
No. 12	28	5,38	20 x 7	10685	
1/4	28	6,24	20 x 7	10686	
5/16	24	7,82	25 x 9	10687	
3/8	24	9,41	30 x 11	10688	
7/16	20	10,98	30 x 11	10689	
1/2	20	12,56	38 x 10	10690	
9/16	18	14,14	38 x 10	10691	
5/8	18	15,73	45 x 14	10692	
3/4	16	18,89	45 x 14	10693	
7/8	14	22,05	55 x 16	10694	
1	14 (NS)	25,16	55 x 16	10695	
1	12	25,21	55 x 16	10696	

Weitere Abmessungen auf Anfrage lieferbar | Other sizes available on request

Einschnittgewindebohrer DIN 352

Short Machine Taps DIN 352

EXACT
PRÄZISIONSWERKZEUGE

Anschnittlängen | Chamfer

metrisch | metric



Form B: 4 - 5 Gang Anschnitt mit Schälanschnitt für Durchgangslöcher

Form B: 4 - 5 pitch chamfer, spiral point for through holes



Form B-AZ: 4 - 5 Gang Anschnitt mit Schälanschnitt mit ausgesetzten Zähnen für Durchgangslöcher

Form B-AZ: 4 - 5 pitch chamfer, spiral point with interrupted thread for through holes

metrisch fein | metric fine



Form D: Kurze Ausführung für Durchgangs- und Sacklöcher

Form D: Short version for through and blind holes

Metrisch | Metric

M

HSS-E

Form B



M

HSS-E

Form B-AZ



Technische Information

- HSS = Hochleistungsschnell-Stahl
 HSS-E = Hochleistungsschnell-Stahl Klasse E
 Form B = Mit Schälanschnitt, 5-Gang Anschnitt
 Kurze Ausführung für Durchgangslöcher.
 Form B-AZ = Besonders geeignet für die Bearbeitung von
 Bronze, Kupfer, Nickel usw.
 DIN 352 • Für metrisches ISO-Gewinde DIN 13, Toleranz 6H

Technical Information

- HSS = High-speed-steel
 HSS-E = High-speed-steel E-class
 Form B = 5-pitch chamfer, spiral point
 Short version for through holes.
 Form B-AZ = Ideal for machining bronze,
 copper, nickel, etc.
 DIN 352 • For metric ISO-thread DIN 13, tolerance 6H

Anwendung

Für Hand- und Maschinengebrauch.

Application

For manual and machine use.

M	mm	mm	mm	mm	mm	CODE	€	CODE	€
M 3	0,50	2,50	11	40	2,7	02021		02061	
M 4	0,70	3,30	13	45	3,4	02022		02062	
M 5	0,80	4,20	16	50	4,9	02023		02063	
M 6	1,00	5,00	19	50	4,9	02024		02064	
M 8	1,25	6,75	22	56	4,9	02025		02065	
M 10	1,50	8,50	24	70	5,5	02026		02066	
M 12	1,75	10,25	29	75	7,0	02027		02067	
M 14	2,00	12,00	30	80	9,0	02028			
M 16	2,00	14,00	32	80	9,0	02029			
M 18	2,50	15,50	40	95	11,0	02030			
M 20	2,50	17,50	40	95	12,0	02031			

Einschnittgewindebohrer DIN 2181

Short Machine Taps DIN 2181

Metrisch fein | Metric fine



Technische Information

HSS-E = Hochleistungsschnell-Stahl Klasse E
 Form D = Kurze Ausführung für Durchgangslöcher und Sacklöcher
 DIN 2181 • Für metrisches ISO-Feingewinde DIN 13, Toleranz 6H

Anwendung

Für Hand- und Maschinengebrauch.

Technical Information

HSS-E = High-speed-steel E-class
 Form D = Short version for through holes and blind holes
 DIN 2181 • For metric ISO-thread DIN 13, tolerance 6H

Application

For manual and machine use.

Mf	mm	mm	mm	mm	mm	CODE	€
Mf 6	0,75	5,25	14	50	4,9	02071	
Mf 8	0,75	7,25	19	50	4,9	02072	
Mf 8	1,00	7,00	22	56	4,9	02073	
Mf 10	1,00	9,00	20	63	5,5	02074	
Mf 12	1,00	11,00	22	70	7,0	02075	
Mf 12	1,50	10,50	22	70	7,0	02076	
Mf 14	1,25	12,75	22	70	9,0	02077	
Mf 14	1,50	12,50	22	70	9,0	02078	
Mf 16	1,50	14,50	22	70	9,0	02079	
Mf 18	1,50	16,50	22	80	11,0	02080	
Mf 20	1,50	18,50	22	80	12,0	02081	
Mf 22	1,50	20,50	22	80	14,5	02082	
Mf 24	1,50	22,50	22	90	14,5	02083	

Amerikanisches kegeliges Rohrgewinde NPT | American tapered pipe thread NPT



Technische Information

HSS = Hochleistungsschnell-Stahl
 Form D = Kurze Ausführung für Durchgangs- und Sacklöcher
 Kegel 1:16

Anwendung

Für Hand- und Maschinengebrauch.

Technical Information

HSS = High-speed-steel
 Form D = Short version for through and blind holes
 Taper 1:16

Application

For manual and machine use.

NPT	mm	mm	mm	mm	mm	CODE	€
1/16	27	6,30	17,50	60	5,5	02041	
1/8	27	8,50	20,00	63	5,5	02042	
1/4	18	11,00	28,00	63	9,0	02043	
3/8	18	14,30	28,00	71	9,0	02044	
1/2	14	18,00	36,00	80	12,0	02045	
3/4	14	23,00	36,00	100	16,0	02046	
1	11 1/2	29,00	45,00	110	20,0	02047	

Einschnittgewindebohrer • Short Machine Taps

Einschnittgewindebohrer DIN 352

Short Machine Taps DIN 352

EVENTUS[®]
by EXACT

Anschnittlängen | Chamfer

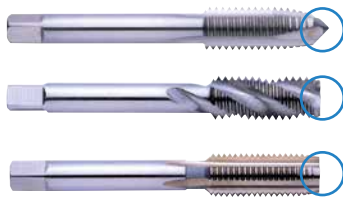

- Form B** 4 - 5 Gang Ansnitt mit Schälanschnitt für Durchgangslöcher
- Form B** 4 - 5 pitch chamfer, spiral point for through holes
- 35° RSP** 2 - 3 Gang Ansnitt für Sacklöcher
- 35° RSP** 2 - 3 pitch chamfer, spiral point with interrupted thread for through holes
- Form D** Für Durchgangs- und Sacklöcher
- Form D** For through and blind holes

Metrisch | Metric



Technische Information

HSS = Hochleistungsschnell-Stahl
 Form B = 5 Gang Ansnitt mit Schälanschnitt, für Durchgangslöcher
 35° RSP = 2 Gang Ansnitt für Sacklöcher • Kurze Ausführung
 DIN 352 • Für metrisches ISO-Gewinde DIN 13, Toleranz 6H

Technical Information

HSS = High-speed-steel
 Form B = 5-pitch chamfer, spiral point for through holes
 35° RSP = 2-pitch chamfer for blind holes • Short version
 DIN 352 • For metric ISO-thread DIN 13, tolerance 6H

Anwendung

Für Hand- und Maschinengebrauch.

Application

For manual and machine use.

M	mm	mm	mm	mm	CODE	€	CODE	€
M 3	0,50	2,50	11	40	20001		20031	
M 4	0,70	3,30	13	45	20002		20032	
M 5	0,80	4,20	16	50	20003		20033	
M 6	1,00	5,00	19	50	20004		20034	
M 8	1,25	6,75	22	56	20005		20035	
M 10	1,50	8,50	24	70	20006		20036	
M 12	1,75	10,25	29	75	20007		20037	
M 14	2,00	12,00	30	80	20064			
M 16	2,00	14,00	32	80	20065			
M 18	2,50	15,50	40	95	20066			
M 20	2,50	17,50	40	95	20067			
M 22	2,50	19,50	40	100	20068			
M 24	3,00	21,00	50	110	20069			

Einschnittgewindebohrer Short Machine Taps

DIN 2181 • Metrisch fein | DIN 2181 • Metric fine

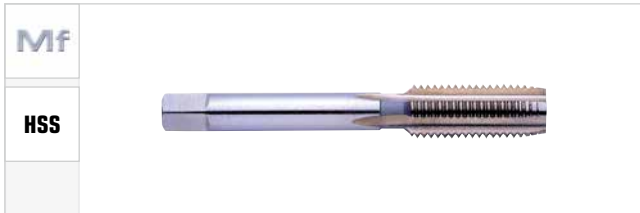

Technische Information

HSS = Hochleistungsschnell-Stahl
Kurze Ausführung für Durchgangs- und Sacklöcher.
DIN 2181 • Für metrisches ISO-Feingewinde DIN 13, Toleranz 6H

Anwendung

Für Hand- und Maschinengebrauch.

Technical Information

HSS = High-speed-steel
Short version for through and blind holes.
DIN 2181 • For metric ISO-thread DIN 13, tolerance 6H

Application

For manual and machine use.

Mf					CODE	€
Mf 6	0,75	5,25	14	50	20101	
Mf 8	0,75	7,25	19	50	20102	
Mf 8	1,00	7,00	22	56	20103	
Mf 10	1,00	9,00	20	63	20104	
Mf 12	1,00	11,00	22	70	20105	
Mf 12	1,50	10,50	22	70	20106	
Mf 14	1,25	12,75	22	70	20107	
Mf 14	1,50	12,50	22	70	20108	
Mf 16	1,50	14,50	22	70	20109	
Mf 18	1,50	16,50	22	80	20110	
Mf 20	1,50	18,50	22	80	20111	
Mf 22	1,50	20,50	22	80	20112	
Mf 24	1,50	22,50	22	90	20113	

DIN 5157 • Whitworth-Rohrgewinde (G) | DIN 5157 • Whitworth pipe thread (G)



Technische Information

HSS = Hochleistungsschnell-Stahl
Für Whitworth-Rohrgewinde (Gas) DIN 259 ISO 228 / Teil 1
Kurze Ausführung für Durchgangs- und Sacklöcher.

Anwendung

Für Hand- und Maschinengebrauch.

Technical Information

HSS = High-speed-steel
For Whitworth pipe thread (gas) DIN 259 ISO 228 / Part 1
Short version for through and blind holes.

Application

For manual and machine use.

G BSP					CODE	€
1/8	28	8,80	20	63	20181	
1/4	19	11,80	22	70	20182	
3/8	19	15,30	22	70	20183	
1/2	14	19,00	22	80	20184	
3/4	14	24,50	22	90	20185	
1	11	30,50	25	100	20186	
1 1/4	11	39,50	40	125	20187	
1 1/2	11	45,00	40	140	20188	
2	11	57,00	40	160	20189	

Einschnittgewindebohrer DIN 351

Short Machine Taps DIN 351

EVENTUS[®]
by EXACT

UNC | UNC



Technische Information

HSS = Hochleistungsschnell-Stahl
Kurze Ausführung für Durchgangs- und Sacklöcher.
DIN 351 • Für UNC-Gewinde (Unified-Grobgewinde), Toleranz 2B

Anwendung

Für Hand- und Maschinengebrauch.

Technical Information

HSS = High-speed-steel
Short version for through and blind holes.
DIN 351 • For UNC thread (Unified coarse thread), tolerance 2B

Application

For manual and machine use.

UNC	mm	mm	mm	mm	CODE	€
1/4	20	5,20	22	56	20201	
5/16	18	6,60	22	56	20202	
3/8	16	8,00	25	70	20203	
7/16	14	9,40	30	75	20204	
1/2	13	10,80	30	75	20205	
9/16	12	12,30	32	80	20206	
5/8	11	13,50	32	80	20207	
3/4	10	16,50	40	95	20208	

UNF | UNF



Technische Information

HSS = Hochleistungsschnell-Stahl
Kurze Ausführung für Durchgangs- und Sacklöcher.
Für UNF-Gewinde (Unified-Feingewinde), Toleranz 2B

Anwendung

Für Hand- und Maschinengebrauch.

Technical Information

HSS = High-speed-steel
Short version for through and blind holes.
For UNF thread (Unified fine thread), tolerance 2B

Application

For manual and machine use.

UNF	mm	mm	mm	mm	CODE	€
1/4	28	5,50	18	56	20221	
5/16	24	6,90	18	63	20222	
3/8	24	8,50	18	63	20223	
7/16	20	9,90	18	63	20224	
1/2	20	11,50	20	63	20225	
9/16	18	13,00	20	70	20226	
5/8	18	14,60	20	70	20227	
3/4	16	17,50	22	80	20228	



Für Ihre Notizen
For your notes

EVENTUS[®]
by EXACT



Auszug | Example

TIPP!

Zum leichteren lotgerechten Anschneiden gibt es eisenführungen. Die Führungen für Schneisen werden zusammen mit dem Schneisen in Schneisenhalter festigt. Das Führungsrohr hat genau den Bolzendurchmesser der Größe des zu schneidenden Gewindes. Somit wird der Anschnitt lotgerecht ausgeführt und die Gewindeflanken werden sauber geschnitten. Die Führungen werden im Druckgussverfahren aus Aluminium hergestellt und haben eingearbeitete Spanlöcher, damit die Späne entsprechend abgeführt werden können.

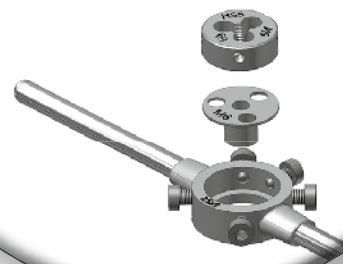

Gewindehandbuch

Thread Cutting Guide

Alles was Sie über Gewindeschneiden wissen sollten
- zusammengefasst auf 72 Seiten!

You will find everything that you need to know
about thread cutting on 72 pages!



Qualitätsmerkmale | Quality references

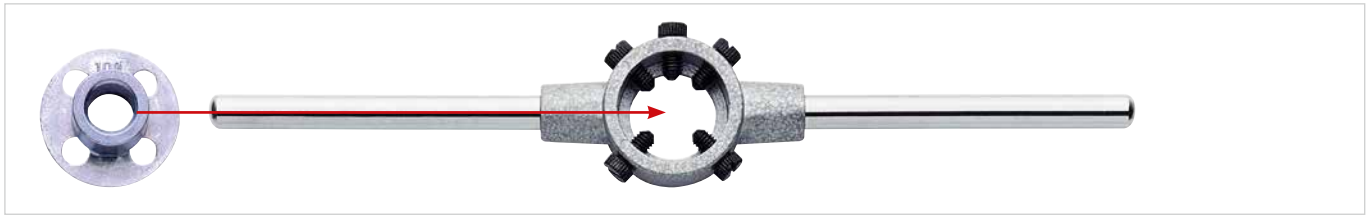

Vorteile

- Genaue fluchtende Gewinde
- Saubere Gewindeflanken
- Weniger Ausschuss
- Gute Spanabfuhr, da Führung mit Spanlöchern
- Bei kleinen Serien preisgünstiger von Hand arbeiten, als Maschinen zu belasten
- Schneiden von Rechts- und Linksgewinden, sowie alle vorkommenden Gewinde-Steigungen

Advantages

- Allows precise alignment of threads
- Better swarf removal
- Reduced rejection rate
- The guide allows quick and accurate production of small volumes, to be produced by hand and therefore eliminates the necessity to set up machines for small productions
- For right- and lefthand threads, and it can be used with thread pitches within the same diameters



Technische Information

Für Schneideisen **DIN 223 = EN 22568** und Schneideisenhalter **DIN 225 = EN 22568**

Technical Information

For Circular Dies **DIN 223 = EN 22568** and holder for Circular Dies **DIN 225 = EN 22568**

Anwendung

Hilfe zum Schneiden von Außengewinden. Die Führung wird zusammen mit dem Schneideisen in den Schneideisenhalter eingelegt.

Application

Aid for cutting external threads. Put the guides together with the Circular Die in the holder for Circular Dies.

No.	M	CODE	€	€ SET
1	M 3	05191	3,30	
2	M 4	05192	3,30	
3	M 5	05193	3,30	
4	M 6	05194	3,30	
5	M 8	05195	3,30	
6	M 10	05196	3,30	
7	M 12	05197	4,65	
1 - 7	M 3 - M 12	05198		

Für Schneideisen Ø 25x9 | For Circular Dies Ø 25x9

	M	CODE	€	€ SET
	M 3	15191	2,80	
	M 4	15192	2,80	
	M 5	15193	2,80	
	M 6	15194	2,80	
	M 8	15195	2,80	
	M 10	15196	2,80	
	M 12	15197	2,80	
		M 3 - M 12	15198	

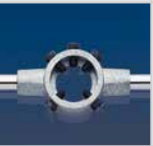

Schneideisenhalter DIN EN 22568

Holder for Circular Dies DIN EN 22568

EXACT
PRÄZISIONSWERKZEUGE

Haltewerkzeuge • Tool holder

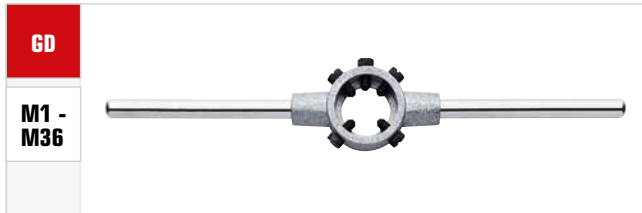

Technische Information

GD = aus Zinkdruckguss (GD)
STAHL = aus Temperguss (GT)

Anwendung

Zur Aufnahme geschlossener und geschlitzter Schneideisen
DIN 223 / 5158 • EN 22568 / 24230 / 24231

Technical Information

GD = made of zinc pressure casting (GD)
STEEL = made of tempered pressure casting (GT)

Application

For mounting closed and slotted circular dies
DIN 223 / 5158 • EN 22568 / 24230 / 24231

M	Mf	BSW	G BSP			CODE	€	CODE	€
M 1 - M 2,6		1/16 - 3/32		16 x 5	160	04931			
M 3 - M 4		1/8 - 5/32		20 x 5	200	04932			
M 4,5 - M 6		3/16 - 1/4		20 x 7	200	04933			
M 7 - M 9		5/16	1/16	25 x 9	224	04934			
M 10 - M 11		3/8 - 7/16	1/8	30 x 11	280	04935			
M 12 - M 14		1/2 - 9/16		38 x 14	315	04936			
Mf 10 - Mf 15			1/4	38 x 10	315	04937			
M 16 - M 20		5/8 - 3/4		45 x 18	450	04938			
Mf 16 - Mf 20			3/8 - 1/2	45 x 14	450	04939			
M 22 - M 24		7/8 - 1"		55 x 22	560	04940			
Mf 21 - Mf 26			5/8 - 3/4	55 x 16	560	04941			
M 27 - M 36		1 1/8 - 1 3/8		65 x 25	630	04942			
Mf 27 - Mf 36			7/8 - 1	65 x 18	630	04943			
M 39 - M 42		1 1/2 - 1 5/8		75 x 30	800			04914	
Mf 38 - Mf 42			1 1/8 - 1 1/4	75 x 20	800			04915	
M 45 - M 52		1 3/4 - 2"		90 x 36	900			04916	
Mf 45 - Mf 52			1 1/2	90 x 22	900			04917	
M 56 - M 64		2 1/4 - 2 3/4		105 x 36	1000			04918	
M 55 - M 62			1 3/4 - 2	105 x 22	1000			04919	
M 68 - M 76		2 3/4 - 3"		120 x 36	1000			04920	
M 62 - M 80			2 3/8 - 2 3/4	120 x 22	1000			04921	

Windeisen DIN 1814 Tapwrenches DIN 1814

Verstellbare Windeisen | Adjustable Tapwrenches

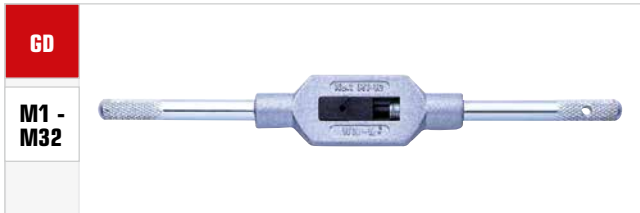

Technische Information

GD = aus Zinkdruckguss (GD)

STAHL = aus Temperguss (GT)

Mit Stahlgriffen; davon 1 Griff abschraubbar

Anwendung

Zum Gewindeschneiden an schwer zugänglichen Stellen. Mit Zweibackenspannfutter zur Aufnahme von Vierkantschäften.

Technical Information

GD = made of zinc pressure casting (GD)

STEEL = made of tempered pressure casting (GT)

1 removable arm

Application

For threading in hard-to-reach positions. With two-jaw chuck for mounting on square shafts.

No.	M	Mf	BSW	G BSP	mm	CODE	€	CODE	€
0	M 1 - M 8		1/16 - 5/16	-	130	04971		04951	
1	M 1 - M 10		1/16 - 3/8	-	175	04972		04952	
1 1/2	M 1 - M 12		1/16 - 1/2	1/8	175	04973		04953	
2	M 3,5 - M 12		5/32 - 1/2	1/8	280	04974		04954	
3	M 5 - M 20		7/32 - 3/4	1/8 - 1/2	375	04975		04955	
4	M 11 - M 27		7/16 - 1	1/4 - 3/4	470	04976		04956	
5	M 13 - M 32		1/2 - 1 1/4	1/4 - 1	700	04977		04957	
6	M 18 - M 42		3/4 - 1 1/2	1/2 - 1 1/4	1000			04958	
7	M 25 - M 52		1 - 1/8	3/4 - 1 3/4	1250			04959	
8	M 25 - M 64		1 - 2 1/2	3/4 - 3	1250			04960	

Kugelwindeisen | Ball Tapwrenches

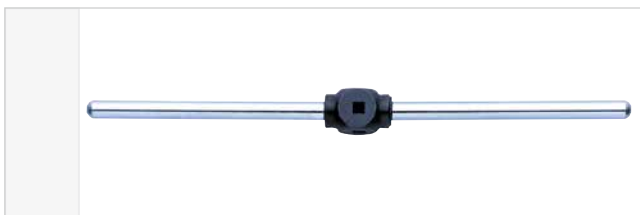

Technische Information

Arme ausschraubbar. Gehäuse aus Zinkdruckguss.

Anwendung

Zur Aufnahme von Gewindewerkzeug mit 4-Kant.

Technical Information

Removable arms. Housing in zinc diecasting.

Application

For directly holding of thread tool with size of square.

No.	M	BSW	mm	CODE	€
0	M 1 - M 4	1/16 - 5/32	200	04991	
1	M 3,5 - M 8	5/32 - 5/16	200	04992	
2	M 4 - M 10	5/32 - 3/8	240	04993	
3	M 5 - M 12	7/32 - 1/2	300	04994	
4	M 9 - M 16	3/8 - 5/8	340	04995	
5	M 12 - M 20	1/2 - 13/16	450	04996	
6	M 18 - M 27	11/16 - 1	650	04997	

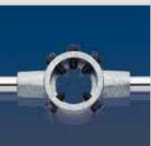

Schneideisenhalter DIN EN 22568 Holder for Circular Dies DIN EN 22568

EXACT
PRÄZISIONSWERKZEUGE

Schneideisenhalter DIN EN 22568 PM | Holder for Circular Dies PM

PM



Vorteile | Advantages

- Hohe Bruchfestigkeit
- Verbesserte Verschleißfestigkeit
- Deutlich leichter als Stahl
- Higher breaking resistance
- Optimised wear resistance
- Lighter than steel holder

Technische Information

PM = Pulvermetallurgisches Metall

Anwendung

Zur Aufnahme geschlossener und geschlitzter Schneideisen
DIN 223 / 5158 • EN 22568 / 24230 / 24231

Technical Information

PM = Powder-metallurgy metal

Application

For mounting closed and slotted circular dies
DIN 223 / 5158 • EN 22568 / 24230 / 24231

M	Mf	BSW	G BSP			CODE	€
M 1 - M 2,6		1/16 - 3/32		16 x 5	160	04922	
M 3 - M 4		1/8 - 5/32		20 x 5	200	04923	
M 4,5 - M 6		3/16 - 1/4		20 x 7	200	04924	
M 7 - M 9		5/16	1/16	25 x 9	224	04925	
M 10 - M 11		3/8 - 7/16	1/8	30 x 11	280	04926	
M 12 - M 14		1/2 - 9/16		38 x 14	315	04927	
Mf 10 - Mf 15			1/4	38 x 10	315	04928	
M 16 - M 20		5/8 - 3/4		45 x 18	450	04929	
Mf 16 - Mf 20			3/8 - 1/2	45 x 14	450	04930	
Mf 21 - Mf 26			5/8 - 3/4	55 x 16	560	04944	
Mf 27 - Mf 36		1 1/8 - 1 3/8	7/8 - 1	65 x 18	630	04945	

Verstellbare Windeisen PM | Adjustable Tapwrenches PM

PM



Vorteile | Advantages

- Hohe Bruchfestigkeit
- Verbesserte Verschleißfestigkeit
- Deutlich leichter als Stahl
- Higher breaking resistance
- Optimised wear resistance
- Lighter than steel holder

Technische Information

PM = Pulvermetallurgisches Metall

Mit Stahlgriffen; davon 1 Griff abschraubbar

Anwendung

Zum Gewindeschneiden an schwer zugänglichen Stellen. Mit Zweibacken-Spannfutter zur Aufnahme von Vierkantschäften.

Technical Information

PM = Powder-metallurgy metal

1 removable arm

Application

For threading in hard-to-reach positions. With two-jaw chuck for mounting on square shafts.

No.	M	Mf	BSW	G BSP		CODE	€
0	M 1 - M 8		1/16 - 1/4	-	125	04961	
1	M 1 - M 10		1/16 - 3/8	1/8	180	04962	
1 1/2	M 1 - M 12		1/16 - 1/2	1/8	200	04963	
2	M 3,5 - M 12		5/32 - 1/2	1/8	280	04964	
3	M 5 - M 20		7/32 - 3/4	1/8 - 1/2	375	04965	
4	M 11 - M 27		7/16 - 1	1/4 - 3/4	500	04966	
5	M 13 - M 32		1/2 - 1 1/4	1/4 - 1	750	04967	



Für Ihre Notizen
For your notes

EXACT
PRÄZISIONSWERKZEUGE



Werkzeughalter mit Knarre Tapwrenches with ratchet

Werkzeughalter mit Knarre | Tapwrenches with ratchet

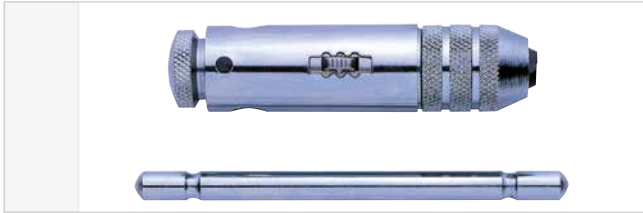

Technische Information

Rechts- und Linksgang, lange und kurze Ausführung für Gewindebohrer.

Artikel 05040 auch geeignet zur Aufnahme von 6-Kantschäften nach DIN 3126.

Anwendung

Zum Gewindeschneiden an schwer zugänglichen Stellen. Mit Zweibacken-Spannfutter zur Aufnahme von Vierkantschäften.

Technical Information

Right- and left-hand, long and short versions for Taps.

Article 05040 can be used for holding of hexagon shanks DIN 3126.

Application

For threading in hard-to-reach positions. With two-jaw chuck for mounting on square shafts.

No.	M	BSW	G BSP	mm	CODE	€
kurz short (MADE IN GERMANY)						
1	M 3 - M 10	1/8 - 3/8		85	05039	
2	M 5 - M 12	7/32 - 1/2	1/8	100	05040	
kurz short						
1	M 3 - M 10	1/8 - 3/8		85	05041	
2	M 5 - M 12	7/32 - 1/2	1/8	100	05042	
lang long						
10	M 3 - M 10	1/8 - 3/8		250	05043	
20	M 5 - M 12	7/32 - 1/2	1/8	300	05044	

Werkzeughalter mit Knarre | Tapwrenches with ratchet



M13 -
M20

Technische Information

Rechts- und Linksgang, lange und kurze Ausführung für Gewindebohrer.

Artikel 05038 auch geeignet zur Aufnahme von 6-Kantschäften nach DIN 3126.

Anwendung

Zum Gewindeschneiden an schwer zugänglichen Stellen. Mit Zweibacken-Spannfutter zur Aufnahme von Vierkantschäften.

Technical Information

Right- and left-hand, long and short versions for Taps.

Article 0538 can be used for holding of hexagon shanks DIN 3126.

Application

For threading in hard-to-reach positions. With two-jaw chuck for mounting on square shafts.

No.	M	mm	CODE	€
BIG				
3	M 13 - M 20	117	05038	

Gewindebohrerverlängerung DIN 377

Tap Extension DIN 377

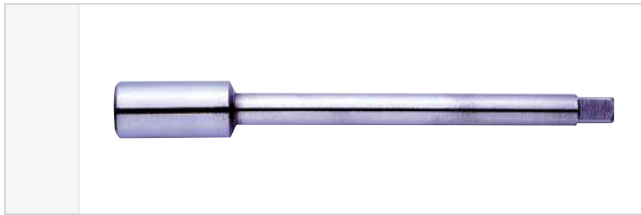

Technische Information

DIN 377 • Innen- und Außenvierkant • Ausführung gehärtet und geschliffen

Anwendung



Zur Verlängerung von Handgewindebohrern

Technical Information

DIN 377 • Square internal and external section • Hardened and ground

Application

For Tap lengthening

	M	Mf	BSW	G BSP		CODE	€
2,1	M 1 - M 2,6		1/16 - 3/32		60	05001	
2,4					70	05002	
2,7	M 3		1/8		80	05003	
3,0	M 3,5				90	05004	
3,4	M 4		5/32		95	05005	
3,8	M 4,5				100	05006	
4,3			3/16		105	05007	
4,9	M 5 - M 8		7/32 - 5/16		110	05008	
5,5	M 9 - M 10		3/8	1/8	115	05009	
6,2	M 11		7/16		120	05010	
7,0	M 12		1/2		125	05011	
8,0					130	05012	
9,0	M 13 - M 16		9/16 - 5/8	1/4 - 3/8	135	05013	
10,0					140	05014	
11,0	M 18		11/16 - 3/4		150	05015	
12,0	M 20		13/16	1/2	155	05016	
13,0					165	05017	
14,5	M 22 - M 26		7/8 - 15/16	5/8	175	05018	
16,0	M 27 - M 28		1	3/4	185	05019	
18,0	M 30 - M 32		1 1/8	7/8	195	05020	
20,0	M 33		1 1/4	1	210	05021	
22,0	M 34 - M 38		1 3/8	1 1/8	220	05022	
24,0	M 39 - M 42		1 1/2 - 1 5/8	1 1/4	235	05023	
26,0					250	05024	
29,0	M 45 - M 50		1 3/4 - 1 7/8	1 3/8 - 1 1/2	265	05025	
32,0	M 52		2	1 3/4	285	05026	



ZUBEHÖR ACCESSORIES

EXACT®

Gewindehandbuch 96
Thread Cutting Guide

Gewindeschablonen

Thread Gauge

■ M	97
■ M / Ww	97
■ M / Ww 55° / Ww-Rohr 55°	97
■ Ww 55°	97
■ Ww-Rohr 55°	97
■ UNF 60°	97
■ US 60°	97

Digital-Messschieber 97
Digital Caliper

Kühl- und Schmierstoffe

Coolants and lubricants

■ Schneidölspray	98
■ Bohrpaste	98
■ Schneidölspray im Thekendisplay	99
■ Bohrpaste im Theklendisplay	99

Gewindekronen 100

Schraubenausdreher 101
Screw Extractors

Gewindefeilen 101
Thread restoring files

Gewindehandbuch | Thread Cutting Guide



Anwendung

Alles was Sie über Gewindeschneiden wissen sollten – zusammengefasst auf 72 Seiten!

Application

You will find everything that you need to know about thread cutting on 72 pages!



		
Handbuch Gewindeschneiden Thread Cutting Guide 72 Seiten Tipps zum Gewindeschneiden DEUTSCH	92500	
englisch, spanisch, russisch, finnisch – auf Anfrage on request		

Produktinformation | Product information

INHALT

- Sicherheitshinweise
- Übersicht Gewindearten
- Geschichte des Gewindes
- Begriffe und Maßklärungen
- Innengewinde
- Fehler beim Gewindeschneiden
- Außengewinde
- Gewindebestimmung
- Gewinde-Reparatur
- Tabellenzitat

ALLGEMEINE HINWEISE

Alle Informations- und Hinweise wurden von den Autoren sorgsam zusammengestellt. Irrtümliche Fehler und Auslassungen können aber nicht ausgeschlossen werden. Wir können deshalb weder eine ausdrückliche noch eine stillschweigende Gewährleistung für die Vollständigkeit und Richtigkeit der Angaben übernehmen. Für Schäden und Verluste, die durch den Gebrauch dieser Information entstehen, übernehmen wir keine Haftung. Und noch ein Hinweis: Bitte lesen Sie die Sicherheitsanweisungen und beachten Sie diese. Sie haben Fragen? Nehmen Sie Kontakt mit uns auf oder besuchen Sie uns im Internet! Anregungen und Weiterungen sind jederzeit willkommen und werden gerne berücksichtigt.

COPYRIGHT

Dieses Benutzerhandbuch ist durch internationale Urheberrechtsgesetze geschützt. Kein Teil dieses Benutzerhandbuchs darf ohne die vorherige schriftliche Genehmigung in irgendeiner Form oder durch elektronische Mittel elektronisch oder mechanisch einschließlich von Fotokopieren, Aufnahmen oder Speichern in einem Informationssystem- oder -netzwerkssystem reproduziert, verteilt, übersetzt oder übertragen werden.



MAN UNTERSCHIEDET HANDGEWINDEBOHRER UND MASCHINENGEWINDEBOHRER.

HANDGEWINDEBOHRER

Der dreiteilige Satz für metrisches ISO-Regelgewinde M 1 bis M 68 besteht aus Vorschneider, Mittelschneider und Fertigschneider. Vorschneider und Mittelschneider haben jeweils Untermaß. Die Größen von M 1 bis M 6 sind mit verstärktem Schaft und in der Regel mit drei Spannschrauben ausgeführt. Die Größen von M 7 bis M 68 haben in der Regel einen durchfallenden Schaft und vier Spannschrauben. Der Gewindebohrersatz für Feingewinde (MF) besteht nur aus Vor- und Fertigschneider.

MASCHINENGEWINDEBOHRER

Der Maschinengewindebohrer für metrisches ISO-Regelgewinde ist zum Schneiden von Innengewinden für den Maschinengebrauch geeignet. Die Ausführung DN 371 hat einen verstärkten Schaft bis M 10 und die Ausführung DN 376 hat einen durchfallenden Schaft (Überlaufbohrer M 3,5 bis M 68).



WINDSEISEN

Das verstellbare Windseisen mit gehärteten Spannböcken aus Stahl hat gerändelte Stützgriffe, die an einer Seite abschraubbar sind. Es ist für Gewindebohrer mit Vierkantschaft und Gewindebohrer-Verlängerungen geeignet. Der Körper ist aus feinem Zinkdruckguss nach DIN 1743 gegossen.

WERKZEUGHALTER

Werkzeughalter mit umschaltbarer Klemme sind zur Aufnahme von Gewindebohrern mit Vierkantschaft im gehärteten Zwickbacken-Bohrerfutter ausgelegt. Der Körper ist ganz aus Stahl gefertigt. Mit einem Schieber ist der Rechts- und Linkslauf einstellbar. Der Werkzeughalter ist in zwei Größen für Gewindebohrer M 3 bis M 10 und M 5 bis M 12 verfügbar und hat einen verschiebbaren Guisgriff mit Rillen an beiden Enden zum Erweitern der Anheberränge.



HERSTELLUNG VON AUSSENGEWINDEN

Der Rundstift wird in Form einer Kegelkappe gedreht. Damit wird das Anschneiden erleichtert. Legen Sie das Schneidseisen in den Schneideseisenhalter, schen Sie darauf, dass die Kerbe in Höhe der mittleren Schraube justiert wird. Ziehen Sie mit dem beiliegendem Schraubendreher die Schrauben fest an, damit das Schneidseisen nicht verrutschen kann. Achten Sie außerdem darauf, dass die Schrauben in die Vorbohrungen des Schneidseisens und in der oberen Kerbe des Schneidseisens greifen, um einen sicheren Halt zu gewährleisten. Sie können das Schneidseisen von beiden Seiten benutzen. Es verfügt auf jeder Seite über einen Anschnitt.

Achten Sie auf einen geraden Anschnitt und schmelzen Sie mit Schneidöl. Danach wird das Schneidseisen mit leichtem Druck auf den Boden aufgedreht. Drücken Sie das Schneidseisen ab und zu zurück, damit die Späne brechen können.

TIPP!

Zum leichteren lotgerechten Anschneiden gibt es Schneidseisenführungen. Die Führungen für Schneidseisen werden zusammen mit dem Schneidseisen im Schneideseisenhalter befestigt. Die Führungsbohrer hat genau den Bohrerdurchmesser der Größe des zu schneidenden Gewindes. Somit wird der Anschnitt lotgerechter ausgeführt und die Drehmomenten werden sauber geschritten. Die Führungen werden im Druckgussverfahren aus Aluminium hergestellt und haben eingearbeitete Spaltlöcher, damit die Späne entsprechend abgeführt werden können.

Gewindeschablonen | Thread Gauge



Technische Information
Für Außen- und Innenmessungen

Technical Information
For gauging of threads

No.				CODE	€
M	0,5 - 1,75	0,5 - 0,6 - 0,7 - 0,75 - 0,8 - 0,9 - 1,0 - 1,25 - 1,5 - 1,75 - 27 - 28	12	50521	
M	0,25 - 6,0	0,25 - 0,3 - 0,35 - 0,4 - 0,45 - 0,5 - 0,6 - 0,7 - 0,75 - 0,8 - 0,9 - 1,0 - 1,25 - 1,5 - 1,75 - 2,0 - 2,5 - 3,0 - 3,5 - 4,0 - 4,5 - 5,0 - 5,5 - 6,0	24	50522	
M	0,4 - 7,0	0,4 - 0,5 - 0,7 - 0,75 - 0,8 - 1,0 - 1,25 - 1,5 - 1,75 - 2,0 - 2,5 - 3,0 - 3,5 - 4,0 - 4,5 - 5,0 - 5,5 - 6,0 - 6,5 - 7,0	20	50504	
M	0,25 - 6,0	0,25 - 0,3 - 0,35 - 0,4 - 0,45 - 0,5 - 0,6 - 0,7 - 0,75 - 0,8 - 0,9 - 1,0 - 1,25 - 1,5 - 1,75 - 2,0 - 2,5 - 3,0 - 3,5 - 4,0 - 4,5 - 5,0 - 5,5 - 6,0	52	50523	
Ww	4 - 62	4 - 4,5 - 5 - 6 - 7 - 8 - 9 - 10 - 11 - 12 - 13 - 14 - 16 - 18 - 19 - 20 - 22 - 24 - 25 - 26 - 28"			
M	0,25 - 6,0	0,25 - 0,3 - 0,35 - 0,4 - 0,45 - 0,5 - 0,6 - 0,7 - 0,75 - 0,8 - 0,9 - 1,0 - 1,25 - 1,5 - 1,75 - 2,0 - 2,5 - 3,0 - 3,5 - 4,0 - 4,5 - 5,0 - 5,5 - 6,0	58	50524	
Ww 55° / Ww-Rohr 55°	4 - 62				
	8 - 28	4 - 4,5 - 5 - 6 - 7 - 8 - 9 - 10 - 11 - 12 - 13 - 14 - 16 - 18 - 19 - 20 - 22 - 24 - 25 - 26 - 28"			
Ww 55°	4 - 30	4 - 4,5 - 5 - 6 - 7 - 8 - 9 - 10 - 11 - 12 - 13 - 14 - 16 - 18 - 19 - 22 - 24 - 26 - 28 - 30"	20	50525	
Ww 55°	4 - 62	4 - 4,5 - 5 - 6 - 7 - 8 - 9 - 10 - 11 - 12 - 13 - 14 - 16 - 18 - 19 - 20 - 22 - 24 - 25 - 26 - 28 - 30 - 32 - 36 - 40 - 48 - 60 - 62	28	50526	
Ww-Rohr 55°	8 - 28	8 - 10 - 11 - 14 - 19 - 28	6	50527	
UNC 60°	4 - 64	4 - 4,5 - 5 - 6 - 7 - 8 - 9 - 10 - 11 - 12 - 13 - 14 - 16 - 18 - 20 - 24 - 32 - 40 - 48 - 56 - 64	22	50528	
UNF 60°	12 - 80	12 - 14 - 16 - 18 - 20 - 24 - 28 - 32 - 36 - 40 - 44 - 48 - 56 - 64 - 72 - 80	16	50529	
US 60°	4 - 42	4 - 4,5 - 5 - 5,5 - 6 - 7 - 8 - 9 - 10 - 11 - 11,5 - 12 - 13 - 14 - 15 - 16 - 18 - 20 - 22 - 24 - 26 - 27 - 28 - 30 - 32 - 34 - 36 - 38 - 40 - 42	30	50530	
US 60°	10 - 40	10 - 11 - 12 - 13 - 14 - 16 - 18 - 20 - 24 - 27 - 28 - 32 - 36 - 40	14	50531	

Digital-Messschieber | Digital Caliper



Technische Information
Ablesung 0,01 mm / 0,0005", Maßgenauigkeit
0,02 mm / 0,0015", rostfreier Stahl,
4 fach Messung

Technical Information
Reading 0,01 mm / 0,0005",
acc. 0,02 mm / 0,0015",
stainless steel, hardened and ground

INHALT	CODE	€
Messbereich 150 mm / 6 inch Ablesung 0,01 / 0,001 Schalter manuell	50512	



Produktinformation | Product information

Eigenschaften

Das Schneidöl-Spray Universal und die Bohrpaste bieten hervorragende Trenn- und Kühlwirkung. Beide erzeugen eine hohe Oberflächengüte und erhöhen die Werkzeugstandzeiten auch bei harten und spröden Materialien.

Properties

The universal cutting spray and the drilling paste provide for optimum cutting and cooling performance. Both produce a high surface quality and increase tool service lives, even for hard and brittle materials.

- Elastischer Schmierfilm mit Korrosionsschutz
- Hochbelastbar durch tragfähige Grenzschichtbildung
- Gezielte und saubere Anwendung beim Schneiden
- Gute Haftung auf allen Oberflächen
- Hohe Standzeiten der Werkzeuge: dadurch weniger Verschleiß
- Größere Schnittgeschwindigkeit: dadurch schnelleres Arbeiten möglich
- Besonders geeignet zum Gewindeschneiden, Bohren, Drehen, Fräsen, Reiben, Sägen und Stanzen von Stahl, Messing, Kupfer und vielen anderen Legierungen
- Sehr ergiebig und effizient im Verbrauch durch Dosiersprühkopf

- Elastic film of lubricant with corrosion protection
- Stress resistant thanks to formation of stable boundary layer
- Effective and clean use for cutting
- Good adhesion to all surfaces
- Long tool service lives: less wear as a result
- Higher cutting speed: for faster working
- Particularly suitable for threading, drilling, turning, milling, reaming, sawing and punching of steel, brass, copper and many other alloys
- Spray nozzle for highly economical and efficient use

Umwelt

Inhaltsstoffe sind frei von Blei, Schwefel, Chlor und PCB.

Environment

Constituents contain no lead, sulphur, chlorine or PCB.

Schneidöl-Spray • Bohrpaste | Cutting spray • Drilling paste

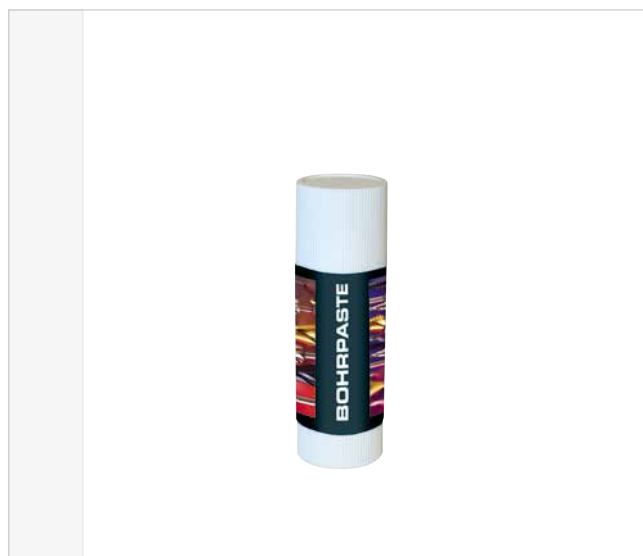

INHALT	CODE	€
1 Dose Schneidöl-Spray à 50 ml	05265	
1 Dose Schneidöl-Spray à 400 ml	05262	

INHALT	CODE	€
1 praktischer Drehstick Bohrpaste à 30 g	05261	
1 praktischer Drehstick Bohrpaste à 50 g	05266	



Schneidöl-Spray in Thekendisplay | Cutting spray in a counter display



Dekoratives, verkaufsförderndes Thekendisplay, befüllt mit 9 Dosen Schneidöl-Spray (Füllmenge je Dose 420 ml).

Format Thekendisplay (Breite / Höhe / Tiefe): 20,5 x 28,5 x 21 cm

Decorative, promotional counter display, containing 9 cans of cutting spray (400 ml in each spray can).

Counter display size (Width / Height / Depth): 20,5 x 28,5 x 21 cm

 INHALT	 CODE	 SET
Display mit 9 Dosen Schneidöl-Spray à 400 ml	05263	

Bohrpaste in Thekendisplay | Drilling paste in a counter display





Dekoratives, verkaufsförderndes Thekendisplay, befüllt mit 18 Stück Bohrpasten (Füllmenge je 30 g).

Format Thekendisplay (Breite / Höhe / Tiefe): 14 x 19,5 x 21 cm

Decorative, promotional counter display, containing 18 units of drilling paste (30 g in each unit).

Counter display size (Width / Height / Depth): 14 x 19,5 x 21 cm

 INHALT	 CODE	 SET
Display mit 18 Stück Bohrpasten à 30 g	05264	

Gewindekronen



Technische Information

Die Gewindekronen Typ 3 sind für Gewindebohrer mit 3 Nuten

Vorteile

Zum Entfernen abgebrochener Gewindebohrer ist die Gewindekrone das ideale Werkzeug – Sie sparen Zeit und Geld.

Technical Information

Gewindekronen Typ 3 for Taps with 3 flutes

Application

Professional tool for removing broken taps. Parts are often very cost-intensive and broken taps requires a lot of time and money to remove to prevent the part from becoming scrap.

Anwendung | Application



1.) Zum Entfernen des abgebrochenen Gewindebohrers führt man die Stege der Gewindekrone in die Nuten des Bruchstückes ein (gegebenenfalls hilft man mit leichten Hammerschlägen nach).

2.) Mit einem Windeisen wird durch gefühlvolles Hin- und Herbewegen der Gewindekrone, das Bruchstück im Werkstück gelöst.

3.) Kleinere Bruchstücke des Gewindebohrers müssen mittels einer Reißnadel oder ähnliches unbedingt vorher entfernt werden, da sonst die Bruchstücke ein Herausdrehen des Gewindebohrers erschweren und die Gewindekrone beschädigen könnten.

4.) Durch Drehen entgegen der Gewinderichtung wird das Bruchstück aus dem Werkzeug entfernt. Bei kleineren Größen ist hierbei mit Gefühl zu verfahren.

1.) To remove the broken tap, insert the webs of the Gewindekrone in the grooves of the broken bit, assist with light blows of a hammer if necessary.

2.) Using a tap wrench, loosen the broken tap in the part with slow to and fro moves of the Gewindekrone.

3.) Smaller tap fragments must be removed with a marking or similar tool before the broken tap is taken out because if they are not removed, the fragments make pulling out the tap more difficult and are likely to damage the Gewindekrone.

4.) Remove the broken pieces from the part by turning in opposite direction of the tap run. Proceed with care especially with small bits.

TYP	Gr.	i	CODE	€
3	0	M 3	60201	
3	1	M 4	60202	
3	2	M 5	60203	
3	3	M 6	60204	
3	4	M 8	60205	
3	5	M10	60206	
3	6	M12	60207	
3	7	M14	60208	
3	8	M16	60209	
3	9	M20	60210	

Schraubenausdreher | Screw Extractors



Technische Information

Aus Chrom-Vanadium-Stahl

Anwendung

Zum Ausdrehen von abgebrochenen Schrauben in Gewinden

Technical Information

Made of chrom-vanadium-steel

Application

Instructions for use: For removing shorn screws in threads

M	G BSP	mm	No.	CODE	€	€ SET
M 3 - M 6	1/8 - 1/4	1,4 - 3,6	1	05121		
M 6 - M 8	1/4 - 5/16	2,1 - 4,9	2	05122		
M 8 - M 11	5/16 - 7/16	3,1 - 6,5	3	05123		
M 11 - M 14	7/16 - 9/16	4,8 - 8,8	4	05124		
M 14 - M 18	9/16 - 3/4	6,2 - 11	5	05125		
M 18 - M 24	3/4 - 1	11 - 14	6	05126		
M 24 - M 33	1 - 1 3/8	14 - 18	7	05127		
M 33 - M 45	1 3/8 - 1 3/4	18 - 24	8	05128		
Sets						
M 3 - M 18	1/8 - 3/4	1,4 - 11	10: 1 - 5	05129		
M 3 - M 24	1/8 - 1	1,4 - 14	20: 1 - 6	05130		
M 3 - M 45	1/8 - 1 3/4	1,4 - 24	30: 1 - 8	05131		

Gewindefeilen | Thread restoring file



Technische Information

HSS = Hochleistungsschnell-Stahl

Anwendung

Zur manuellen Nachbearbeitung von Außengewinden an technischen Bauteilen wie Schrauben, Bolzen, Wellen, Achsen, etc.

Technical Information

HSS = High-speed-steel

Application

For manual finishing of external threads on technical components such as screws, bolts, shafts and axles, etc.

i		mm	CODE	€
ISO metrisch	0,8 - 1,0 - 1,25 - 1,5 - 1,75 - 2,0 - 2,5 - 3,0 mm	230	50509	
WW Whitworth	Gänge per „ 24 - 20 - 18 - 16 - 14 - 12 - 11 - 10	230	50510	



EXACT
HSS-Co

EXACT
HSS-Co

MASCHINENGEWINDE

MACHINE TAPS

EXACT®

EVENTUS®
by EXACT

Universeller Einsatz

Universal using

☐ metrisch	108-111	148-151
☐ metrisch fein	112-114	
☐ BSP (G)	115-117	
☐ UNC	118-120	
☐ UNF	121-123	

Stähle über 1.000 N/mm²

Steel over 1000 N/mm²

⊙ metrisch	124-125	
⊙ metrisch fein	126-127	

VA + rostfreie Stähle

Stainless steel

⊙ metrisch	128-129	
⊙ metrisch fein	130-131	

Guss

Cast material

■ metrisch	132	
------------	------------	--

mit TIN-Beschichtung

with TIN-Coating

▣ metrisch	134-135	152-153
------------	----------------	----------------

mit TiAlN-Beschichtung

with TiAlN-Coating

▣ metrisch	136-137	154-155
------------	----------------	----------------

Spezialbohrer

Special Taps

■ mit ausgesetzten Zähnen	138	
■ Kombigewindebohrer	139	
■ lange Ausführungen	140-141	
■ Muttergewindebohrer	142-143	
■ Gewindeformer	144	

Technische Information

Maschinengewindebohrer mit Farbring-Markierung erleichtern Ihnen die Auswahl der richtigen Bohrer für das zu bearbeitende Material.

- HSS-E = Hochleistungsschnell-Stahl Klasse E
- Form B = für Durchgangslöcher
- Form B-AZ = für Durchgangslöcher
- 35° RSP = für Sacklöcher
- Form C = für Durchgangslöcher und Sacklöcher

Für metrisches ISO-Gewinde DIN 13, Toleranz 6H

Anwendung

Zum Schneiden von Innengewinden.

Technical Information

Machine Taps with colour-rings make it easier to select exactly the right drill for special materials.

- HSS-E = High-speed-steel E-class
- Form B = for through holes
- Form B-AZ = for through holes
- 35° RSP = for blind holes
- Form C = for through holes and blind holes

For metric ISO-thread DIN 13, tolerance 6H

Application

For cutting internal threads.

Form B + B-AZ für Durchgangslöcher | Form B + B-AZ for through holes



Anschnittformen | Chamfer



Form B: 4 - 5 Gang Anschnitt mit Schälanschnitt für Durchgangslöcher
Form B: 4 - 5 pitch chamfer, spiral point for through holes



35° RSP: 2 - 3 Gang Anschnitt, 35° Rechtsspirale, für Sacklöcher
35° RSP: 2 - 3 pitch chamfer, with 35° spiral flute, for blind holes



Form C: 2 - 3 Gang Anschnitt für Durchgangslöcher und Sacklöcher
Form C: 2 - 3 pitch chamfer for through holes and blind holes



Form B-AZ: 4 - 5 Gang Anschnitt mit Schälanschnitt, ausgesetzte Zähne für Durchgangslöcher
Form B-AZ: 4 - 5 pitch chamfer with interrupted thread for through holes

Form 35° RSP für Sacklöcher | Form 35° RSP for blind holes

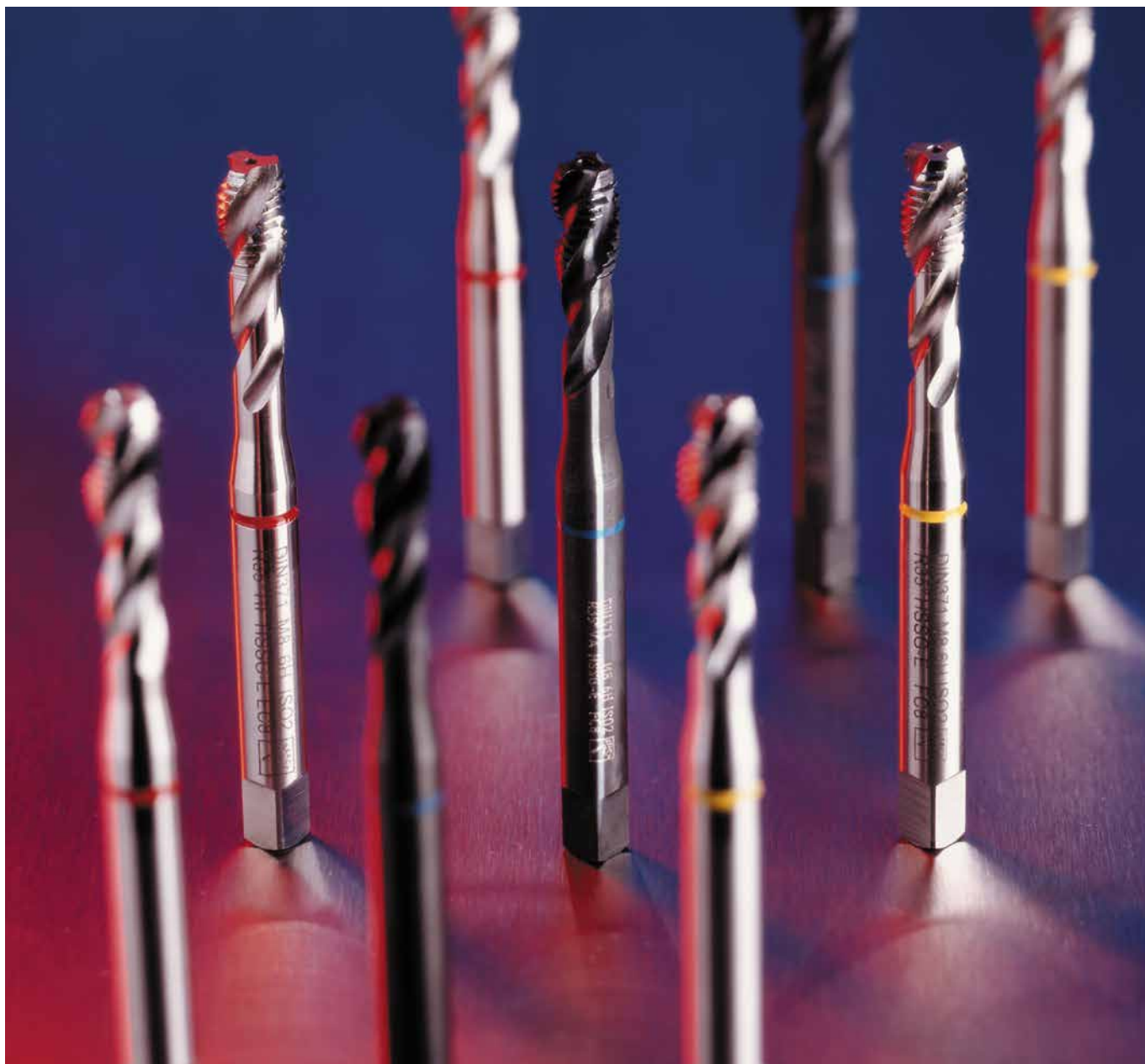











Anwendung Maschinengewindebohrer





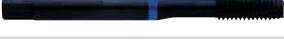





Application Machine Taps

Maschinengewindebohrer • Machine Taps

Maschinengewindebohrer Farbring | Machine Taps Colour-ring

Seite page	Bezeichnung Name	Baustahl	Baustahl	Automatenstahl	Vergütungsstahl	Legierter Stahl	Stahl gehärtet
		Structural steel	Structural steel	Free-cutting steel	Tempered steel	Alloyed steel	Hardened steel
		≤ 500 N/mm ²	> 500 N/mm ²	≤ 1000 N/mm ²	≤ 1000 N/mm ²	≤ 1200 N/mm ²	40 - 60 HRC
 EXACT M MF S BSP UNC UNF 102 106 109 112 115	Form B	●	●	●	○		
 EXACT M MF S BSP UNC UNF 102 107 110 113 116	35° RSP	●	●	●	○		
 EXACT M MF S BSP UNC UNF 104 108 111 114 117	Form C	●	●	●	○		
 EXACT M 105	Form C links left-hand	●	●	●	○		
 EXACT M 133	Kombiboher Combined Tap	●	○				
 EXACT M MF 118 120	Form B	●	●	●	●	●	
 EXACT M MF 118 121	35° RSP	●	●	●	●	●	
 EXACT M MF 122 124	Form B / VAP						
 EXACT M MF 122 125	35° RSP / VAP						
 EXACT M TiCN 126	Form C						

Maschinengewindebohrer | Machine Taps

 EXACT M TIN 128-129	Form B				●	●	
 EXACT M TIN 128-129	35° RSP				●	●	
 EXACT M TiAlN 130-131	Form B				●	●	
 EXACT M TiAlN 130-131	35° RSP				●	●	
 EXACT M 132	Form B-AZ	●	●				
 EXACT M 134	Form B / lang	●	●	●	○		
 EXACT M 135	35° RSP / lang	●	●	●	○		
 EXACT M 136	Muttergewindebohrer Nut Tap	●	●	●	●	○	
 EXACT Tr 137	Muttergewindebohrer Nut Tap	●	●	●	●	○	
 EXACT M NITRIERT 138	Gewindeformer Forming Tap						
 EXACT M TIN 138	Gewindeformer Forming Tap	●	●	●	●		

● empfohlen | recommended ○ bedingt geeignet | partly suitable

VA Stahl VA steel ≤ 850 N/mm ²	VA Stahl VA steel > 850 N/mm ²	Werkzeugstahl Tool steel ≤ 1000 N/mm ²	Guss Cast iron ≤ 300 HB	Kupfer Copper ≤ 400 N/mm ²	Alu + Legierung Alu + Alloy ≤ 450 N/mm ²	Uni Uni	Schneidöl Cutting oil	Emulsion Emulsion	Min. Schmierung Minimum lubrication	Trockenbearbeitung Dry machining
		○		○	○		●	●	●	
		○		○	○		●	●	●	
		○		○	○		●	●	●	
		○		○	○		●	●	●	
○			○		●		●			
		●					●	●	●	
		●					●	●	●	
●	●						●	●	●	
●	●						●	●	●	
			●				●	●	●	

		●					●	●	●	
		●					●	●	●	
		●							●	●
		●							●	●
			●	●		●	●			
		○		○			●	●	●	
		○		○			●	●	●	
●		○	●	●	●		●	●	●	
●		○	●	●	●		●	●	●	
				●	●		●	●		
							●	●		

Maschinengewindebohrer DIN 371 / 376

Machine Taps DIN 371 / 376

EXACT
PRÄZISIONSWERKZEUGE

Metrisch | Metric

M

HSS-E

Form B



Universeller Einsatz

M

HSS-E

35°



Universal Using

Technische Information

HSS-E = Hochleistungsschnell-Stahl Klasse E
 Form B = 5 Gang Anschnitt mit Schälanschnitt für Durchgangslöcher
 35° RSP = 2 Gang Anschnitt für Sacklöcher
 DIN 371 / 376 • Für metrisches ISO-Gewinde DIN 13, Toleranz 6H

Anwendung

Zum Schneiden von Innengewinden.

Technical Information

HSS-E = High-speed-steel E-class
 Form B = 5-pitch chamfer, spiral point for through holes
 35° RSP = 2-pitch chamfer with 35° spiral flute for blind holes
 DIN 371 / 376 • For metric ISO-thread DIN 13, tolerance 6H

Application

For cutting internal threads.

M	mm	mm	mm	mm	mm	mm	mm	CODE	€	CODE	€
M	mm	mm	mm	mm	mm	mm	mm	FORM B	€	35° RSP	€
mit verstärktem Schaft - DIN 371											
M 2,0	0,40	1,60	8	45	2,8	2,1	2,8	42154	€	43559	€
M 2,5	0,45	2,05	9	50	2,8	2,1	2,8	42155	€	43560	€
M 3,0	0,50	2,50	11	56	3,5	2,7	3,5	42156	€	43561	€
M 4,0	0,70	3,30	13	63	4,5	3,4	4,5	42157	€	43562	€
M 5,0	0,80	4,20	16	70	6,0	4,9	6,0	42158	€	43563	€
M 6,0	1,00	5,00	19	80	6,0	4,9	6,0	42159	€	43564	€
M 8,0	1,25	6,75	22	90	8,0	6,2	8,0	42160	€	43565	€
M 10,0	1,50	8,50	16	100	10,0	8,0	10,0	42161	€	43566	€
mit durchfallendem Schaft - DIN 376											
M 12,0	1,75	10,25	29	110	9,0	7,0	9,0	42387	€	43573	€
M 14,0	2,00	12,00	30	110	11,0	9,0	11,0	42388	€	43574	€
M 16,0	2,00	14,00	32	110	12,0	9,0	12,0	42389	€	43575	€
M 18,0	2,50	15,50	34	125	14,0	11,0	14,0	42390	€	43576	€
M 20,0	2,50	17,50	34	140	16,0	12,0	16,0	42391	€	43577	€
M 22,0	2,50	19,50	34	140	18,0	14,5	18,0	42392	€	43578	€
M 24,0	3,00	21,00	38	160	18,0	14,5	18,0	42393	€	43579	€
M 27,0	3,00	24,00	38	160	20,0	16,0	20,0	42395	€	43580	€
M 30,0	3,50	26,50	45	180	22,0	18,0	22,0	42396	€	43581	€
M 33,0	3,50	29,50	50	180	25,0	20,0	25,0	42397	€	43582	€
M 36,0	4,00	32,00	56	200	28,0	22,0	28,0	42398	€	43583	€

Einsatz GELBRING | Application YELLOW RING

Baustahl	Baustahl	Auto- matenstahl Free- cutting steel	Ver- gütungs- stahl Tempered steel	Legierter Stahl Alloyed steel	Stahl gehärtet Hardened steel	VA Stahl VA steel	VA Stahl VA steel	Werk- zeugstahl Tool steel	Guss Cast iron	Kupfer Copper	Alu + Legierung Aluminium + alloy	Uni Uni	Schneidöl Cutting oil	Emulsion Emulsion	Minimal Schmie- rung Minimum lubrication	Trocken- bearbei- tung Dry machining	Pressluft Com- pressed air
≤ 500 N/mm ²	> 500 N/mm ²	≤ 1000 N/mm ²	≤ 1000 N/mm ²	≤ 1200 N/mm ²	40 - 60 HRC	≤ 850 N/mm ²	> 850 N/mm ²	≤ 1000 N/mm ²	≤ 300 HB	≤ 400 N/mm ²	≤ 450 N/mm ²						
●	●	●	○					○		○	○		●	●	●		

● empfohlen | recommended ○ bedingt geeignet | partly suitable



Maschinengewindebohrer-Sets

Machine Tap Sets

EXACT
PRÄZISIONSWERKZEUGE

Metrisch | **Metric**

Maschinengewindebohrer • Machine Taps

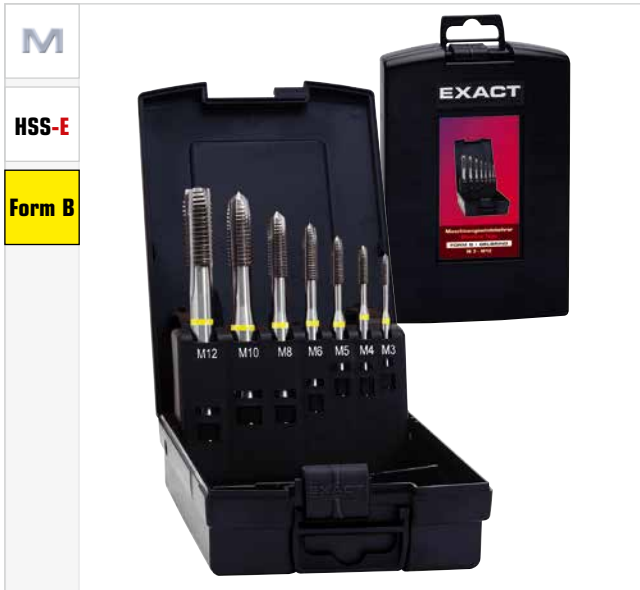



M

HSS-E

Form B

Universeller Einsatz

 <p>INHALT</p>	 <p>CODE FORM B</p>	 <p>€ SET</p>
<p>Maschinengewindebohrer Machine Taps: M3 - M4 - M5 - M6 - M8 - M10 - M12</p>		
	05112	

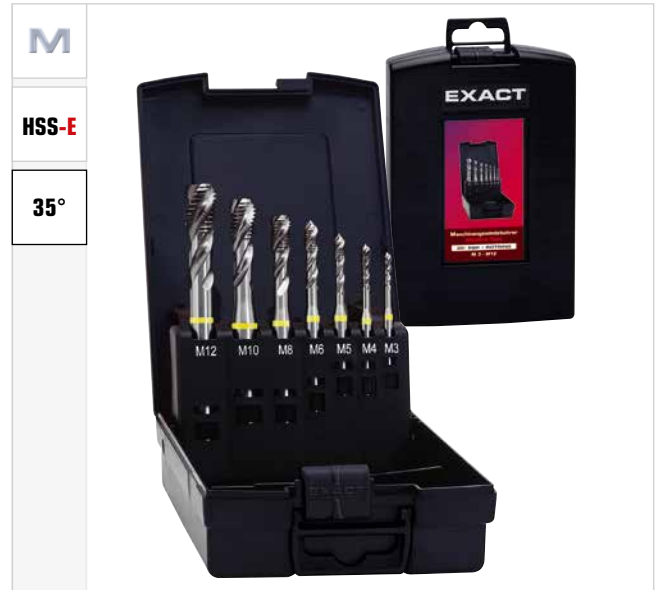



M

HSS-E

35°

Universal Using

 <p>INHALT</p>	 <p>CODE 35° RSP</p>	 <p>€ SET</p>
<p>Maschinengewindebohrer Machine Taps: M3 - M4 - M5 - M6 - M8 - M10 - M12</p>		
	05117	

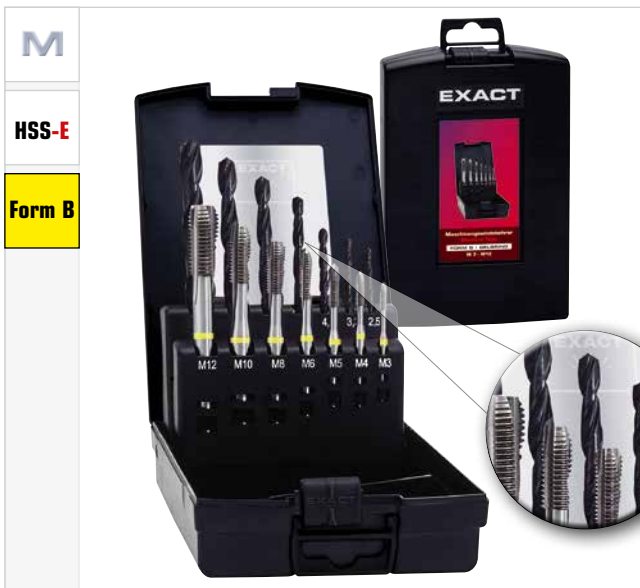

M

HSS-E

Form B

Universeller Einsatz

 <p>INHALT</p>	 <p>CODE FORM B</p>	 <p>€ SET</p>
<p>Maschinengewindebohrer Machine Taps: M3 - M4 - M5 - M6 - M8 - M10 - M12 + Kernlochbohrer Twist Drills: 2,5 - 3,3 - 4,2 - 5 - 6,8 - 8,5 - 10,2</p>		
	05118	

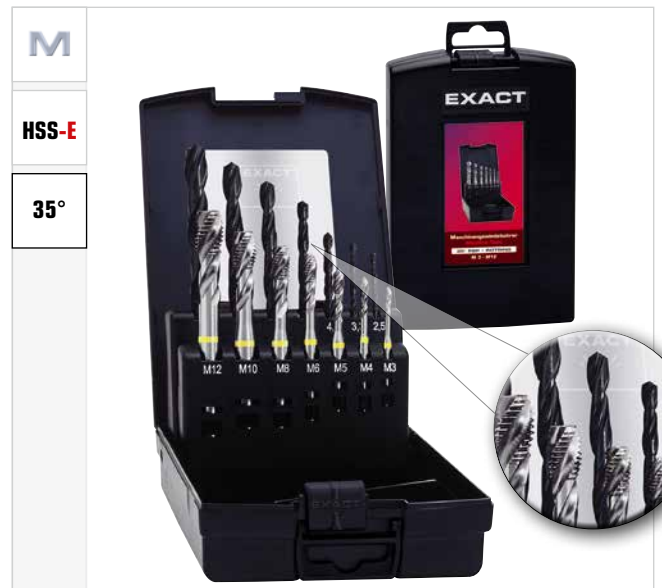

M

HSS-E

35°

Universal Using

 <p>INHALT</p>	 <p>CODE 35° RSP</p>	 <p>€ SET</p>
<p>Maschinengewindebohrer Machine Taps: M3 - M4 - M5 - M6 - M8 - M10 - M12 + Kernlochbohrer Twist Drills: 2,5 - 3,3 - 4,2 - 5 - 6,8 - 8,5 - 10,2</p>		
	05119	

Maschinengewindebohrer DIN 371 / 376

Machine Taps DIN 371 / 376

EXACT
PRÄZISIONSWERKZEUGE

Metrisch | Metric



Technische Information

HSS-E = Hochleistungsschnell-Stahl Klasse E
 Form C = 2-3 Gang Anschnitt für Durchgangs- und Sacklöcher
 DIN 371 / 376 • Für metrisches ISO-Gewinde DIN 13, Toleranz 6H

Technical Information

HSS-E = High-speed-steel E-class
 Form C = 2-3 pitch chamfer for through holes and blind holes
 DIN 371 / 376 • For metric ISO-thread DIN 13, tolerance 6H

Anwendung

Zum Schneiden von Innengewinden. Für kurzspanende Werkstoffe.

Application

For cutting internal threads. For short-chipping materials.

M	mm	mm	mm	mm	mm	mm	CODE	€
mit verstärktem Schaft - DIN 371								
M 2,0	0,40	1,60	8	50	2,8	2,1	02205	
M 2,2	0,45	1,75	9	50	2,8	2,1	02206	
M 2,3	0,40	1,90	9	50	2,8	2,1	02207	
M 2,5	0,45	2,05	9	50	2,8	2,1	02208	
M 2,6	0,45	2,15	9	50	2,8	2,1	02209	
M 3,0	0,50	2,50	11	56	3,5	2,7	02210	
M 3,5	0,60	2,90	13	56	4,0	4,0	02211	
M 4,0	0,70	3,30	13	63	4,5	3,4	02212	
M 5,0	0,80	4,20	16	70	6,0	4,9	02213	
M 6,0	1,00	5,00	19	80	6,0	4,9	02214	
M 7,0	1,00	6,00	19	80	7,0	5,5	02215	
M 8,0	1,25	6,75	22	90	8,0	6,2	02216	
M 9,0	1,25	7,75	22	90	9,0	7,0	02217	
M 10,0	1,50	8,50	24	100	10,0	8,0	02218	
mit durchfallendem Schaft - DIN 376								
M 12,0	1,75	10,25	29	110	9,0	7,0	02417	
M 14,0	2,00	12,00	30	110	11,0	9,0	02418	
M 16,0	2,00	14,00	32	110	12,0	9,0	02419	
M 18,0	2,50	15,50	34	125	14,0	11,0	02420	
M 20,0	2,50	17,50	34	140	16,0	12,0	02421	
M 22,0	2,50	19,50	34	140	18,0	14,5	02422	
M 24,0	3,00	21,00	38	160	18,0	14,5	02423	
M 27,0	3,00	24,00	38	160	20,0	16,0	02424	
M 30,0	3,50	26,50	45	180	22,0	18,0	02425	
M 33,0	3,50	29,50	50	180	25,0	20,0	02426	
M 36,0	4,00	32,00	56	200	28,0	22,0	02427	

Einsatz GELBRING Application YELLOW RING																	
Baustahl	Baustahl	Auto- matenstahl	Ver- gütungs- stahl	Legierter Stahl	Stahl gehärtet	VA Stahl	VA Stahl	Werk- zeugstahl	Guss	Kupfer	Alu + Legierung	Uni	Schneidöl	Emulsion	Minimal Schmie- rung	Trocken- bearbei- tung	Pressluft
Structural steel	Structural steel	Free- cutting steel	Tempered steel	Alloyed steel	Hardened steel	VA steel	VA steel	Tool steel	Cast iron	Copper	Aluminium + alloy	Uni	Cutting oil	Emulsion	Minimum lubrication	Dry machining	Com- pressed air
≤ 500 N/ mm ²	> 500 N/ mm ²	≤ 1000 N/ mm ²	≤ 1000 N/ mm ²	≤ 1200 N/ mm ²	40 - 60 HRC	≤ 850 N/ mm ²	> 850 N/ mm ²	≤ 1000 N/ mm ²	≤ 300 HB	≤ 400 N/ mm ²	≤ 450 N/ mm ²						
●	●	●	○					○		○	○		●	●	●		

● empfohlen | recommended ○ bedingt geeignet | partly suitable

Maschinengewindebohrer DIN 371 / 376

Machine Taps DIN 371 / 376

Metrisch | Metric



Universeller Einsatz



HSS-E

**Form C
Links
Left-hand**

Universal Using

Technische Information

HSS-E = Hochleistungsschnell-Stahl Klasse E
Form C = 2-3 Gang Anschnitt für Durchgangs- und Sacklöcher
DIN 371 / 376 • Für metrisches ISO-Gewinde DIN 13, Toleranz 6H

Technical Information

HSS-E = High-speed-steel E-class
Form C = 2-3 pitch chamfer for through holes and blind holes
DIN 371 / 376 • For metric ISO-thread DIN 13, tolerance 6H

Anwendung

Zum Schneiden von Innengewinden.

Application

For cutting internal threads.

M	mm	mm	mm	mm	mm	mm	mm	CODE	€
mit verstärktem Schaft - DIN 371									
M 3,0	0,50	2,50	11	56	3,5	2,7	02310		
M 4,0	0,70	3,30	13	63	4,5	3,4	02311		
M 5,0	0,80	4,20	16	70	6,0	4,9	02312		
M 6,0	1,00	5,00	19	80	6,0	4,9	02313		
M 8,0	1,25	6,75	22	90	8,0	6,2	02314		
M 10,0	1,50	8,50	24	100	10,0	8,0	02315		
mit durchfallendem Schaft - DIN 376									
M 12,0	1,75	10,25	29	110	9,0	7,0	02316		
M 14,0	2,00	12,00	30	110	11,0	9,0	02317		
M 16,0	2,00	14,00	32	110	12,0	9,0	02318		
M 18,0	2,50	15,50	34	125	14,0	11,0	02319		
M 20,0	2,50	17,50	34	140	16,0	12,0	02320		
M 22,0	2,50	19,50	34	140	18,0	14,5	02329		
M 24,0	3,00	21,00	38	160	18,0	14,5	02330		

Einsatz GELBRING Application YELLOW RING																		
Baustahl	Baustahl	Auto- matenstahl	Ver- gütungs- stahl	Legierter Stahl	Stahl gehärtet	VA Stahl	VA Stahl	Werk- zeugstahl	Guss	Kupfer	Alu + Legierung	Uni	Schneidöl	Emulsion	Minimal Schmie- rung	Trocken- bearbei- tung	Pressluft	
Structural steel	Structural steel	Free- cutting steel	Tempered steel	Alloyed steel	Hardened steel	VA steel	VA steel	Tool steel	Cast iron	Copper	Aluminium + alloy	Uni	Cutting oil	Emulsion	Minimum lubrication	Dry machining	Com- pressed air	
≤ 500 N/ mm ²	> 500 N/ mm ²	≤ 1000 N/ mm ²	≤ 1000 N/ mm ²	≤ 1200 N/ mm ²	40 - 60 HRC	≤ 850 N/ mm ²	> 850 N/ mm ²	≤ 1000 N/ mm ²	≤ 300 HB	≤ 400 N/ mm ²	≤ 450 N/ mm ²							
●	●	●	○					○		○			●	●	●			

● empfohlen | recommended ○ bedingt geeignet | partly suitable

Maschinengewindebohrer DIN 374

Machine Taps DIN 374

Metrisch fein | Metric fine



Mf

HSS-E

Form B

Universeller Einsatz

Universal Using

Technische Information

HSS-E = Hochleistungsschnell-Stahl Klasse E
 Form B = 4-5 Gang Anschnitt mit Schälanschnitt für Durchgangslöcher
 DIN 374 • Für metrisches ISO-Gewinde DIN 13, Toleranz 6H

Technical Information

HSS-E = High-speed-steel E-class
 Form B = 4-5 pitch chamfer, spiral point for through holes
 DIN 374 • For metric ISO-thread DIN 13, tolerance 6H

Anwendung

Zum Schneiden von Innengewinden.

Application

For cutting internal threads.

Mf							CODE	€
Mf 6,0	0,75	5,25	14	80	4,5	3,4	02501	
Mf 8,0	0,75	7,25	19	80	6,0	4,9	02502	
Mf 8,0	1,00	7,00	22	90	6,0	4,9	02503	
Mf 10,0	1,00	9,00	16	90	7,0	5,5	02504	
Mf 10,0	1,25	8,75	24	100	7,0	5,5	02539	
Mf 12,0	1,00	11,00	22	100	9,0	7,0	02505	
Mf 12,0	1,25	10,75	22	100	9,0	7,0	02540	
Mf 12,0	1,50	10,50	22	100	9,0	7,0	02506	
Mf 14,0	1,00	13,00	22	100	11,0	9,0	02507	
Mf 14,0	1,25	12,75	22	100	11,0	9,0	02508	
Mf 14,0	1,50	12,50	22	100	11,0	9,0	02509	
Mf 16,0	1,00	15,00	22	100	12,0	9,0	02510	
Mf 16,0	1,50	14,50	22	100	12,0	9,0	02511	
Mf 18,0	1,00	17,00	22	110	14,0	11,0	02512	
Mf 18,0	1,50	16,50	25	110	14,0	11,0	02513	
Mf 18,0	2,00	16,00	34	125	14,0	11,0	02514	
Mf 20,0	1,00	19,00	25	125	16,0	12,0	02515	
Mf 20,0	1,50	18,50	25	125	16,0	12,0	02516	
Mf 20,0	2,00	18,00	34	140	16,0	12,0	02517	
Mf 22,0	1,00	21,00	25	125	18,0	14,5	02518	
Mf 22,0	1,50	20,50	25	125	18,0	14,5	02519	
Mf 22,0	2,00	20,00	34	140	18,0	14,5	02520	
Mf 24,0	1,00	23,00	28	140	18,0	14,5	02521	
Mf 24,0	1,50	22,50	28	140	18,0	14,5	02522	
Mf 24,0	2,00	22,00	28	140	18,0	14,5	02523	
Mf 26,0	1,50	24,50	28	140	18,0	14,5	02524	
Mf 27,0	2,00	25,00	28	140	20,0	16,0	02525	
Mf 28,0	1,50	26,50	28	150	22,0	18,0	02526	
Mf 30,0	1,50	28,50	28	150	22,0	18,0	02527	
Mf 30,0	2,00	28,00	28	150	22,0	18,0	02528	
Mf 32,0	1,50	30,50	28	150	22,0	18,0	02529	
Mf 35,0	1,50	33,50	30	170	28,0	22,0	02530	
Mf 36,0	1,50	34,50	28	170	28,0	22,0	02531	
Mf 38,0	1,50	36,50	28	170	28,0	22,0	02532	
Mf 40,0	1,50	38,50	30	170	32,0	24,0	02533	
Mf 42,0	1,50	40,50	30	170	32,0	24,0	02534	
Mf 45,0	1,50	43,50	32	180	36,0	29,0	02535	
Mf 48,0	1,50	46,50	32	190	36,0	29,0	02536	
Mf 50,0	1,50	48,50	32	190	36,0	29,0	02537	
Mf 52,0	1,50	50,50	32	190	40,0	32,0	02538	

Maschinengewindebohrer DIN 374

Machine Taps DIN 374

EXACT
PRÄZISIONSWERKZEUGE

Metrisch fein | Metric fine



Universeller Einsatz



Universal Using

Technische Information

HSS-E = Hochleistungsschnell-Stahl Klasse E
35° RSP = 2-3 Gang Anschnitt, 35° Rechtsspirale, für Sacklöcher
DIN 374 • Für metrisches ISO-Gewinde DIN 13, Toleranz 6H

Technical Information

HSS-E = High-speed-steel E-class
35° RSP = 2-3 pitch chamfer, with 35° spiral flute, for blind holes
DIN 374 • For metric ISO-thread DIN 13, tolerance 6H

Anwendung

Zum Schneiden von Innengewinden.

Application

For cutting internal threads.

Mf	mm	mm	mm	mm	mm	mm	CODE	€
Mf 6,0	0,75	5,25	14	80	4,5	3,4	03101	
Mf 8,0	0,75	7,25	19	80	6,0	4,9	03102	
Mf 8,0	1,00	7,00	22	90	6,0	4,9	03103	
Mf 10,0	1,00	9,00	16	90	7,0	5,5	03104	
Mf 10,0	1,25	8,75	24	100	7,0	5,5	03105	
Mf 12,0	1,00	11,00	22	100	9,0	7,0	03106	
Mf 12,0	1,25	10,75	22	100	9,0	7,0	03107	
Mf 12,0	1,50	10,50	22	100	9,0	7,0	03108	
Mf 14,0	1,00	13,00	22	100	11,0	9,0	03109	
Mf 14,0	1,25	12,75	22	100	11,0	9,0	03110	
Mf 14,0	1,50	12,50	22	100	11,0	9,0	03111	
Mf 16,0	1,00	15,00	22	100	12,0	9,0	03112	
Mf 16,0	1,50	14,50	22	100	12,0	9,0	03113	
Mf 18,0	1,00	17,00	22	110	14,0	11,0	03114	
Mf 18,0	1,50	16,50	25	110	14,0	11,0	03115	
Mf 18,0	2,00	16,00	34	125	14,0	11,0	03116	
Mf 20,0	1,00	19,00	25	125	16,0	12,0	03117	
Mf 20,0	1,50	18,50	25	125	16,0	12,0	03118	
Mf 20,0	2,00	18,00	34	140	16,0	12,0	03119	
Mf 22,0	1,00	21,00	25	125	18,0	14,5	03120	
Mf 22,0	1,50	20,50	25	125	18,0	14,5	03121	
Mf 22,0	2,00	20,00	34	140	18,0	14,5	03122	
Mf 24,0	1,00	23,00	28	140	18,0	14,5	03123	
Mf 24,0	1,50	22,50	28	140	18,0	14,5	03124	

Einsatz GELBRING Application YELLOW RING																	
Baustahl	Baustahl	Auto- matenstahl	Ver- gütungs- stahl	Legierter Stahl	Stahl gehärtet	VA Stahl	VA Stahl	Werk- zeugstahl	Guss	Kupfer	Alu + Legierung	Uni	Schneidöl	Emulsion	Minimal Schmie- rung	Trocken- bearbei- tung	Presluft
Structural steel	Structural steel	Free- cutting steel	Tempered steel	Alloyed steel	Hardened steel	VA steel	VA steel	Tool steel	Cast iron	Copper	Aluminium + alloy	Uni	Cutting oil	Emulsion	Minimum lubrication	Dry machining	Com- pressed air
≤ 500 N/ mm ²	> 500 N/ mm ²	≤ 1000 N/ mm ²	≤ 1000 N/ mm ²	≤ 1200 N/ mm ²	40 - 60 HRC	≤ 850 N/ mm ²	> 850 N/ mm ²	≤ 1000 N/ mm ²	≤ 300 HB	≤ 400 N/ mm ²	≤ 450 N/ mm ²						
●	●	●	○					○		○	●		●	●	●		

● empfohlen | recommended ○ bedingt geeignet | partly suitable ● bedingt geeignet für "Form B" | partly suitable for "Form B"

Maschinengewindebohrer DIN 374

Machine Taps DIN 374

Metrisch fein | Metric fine

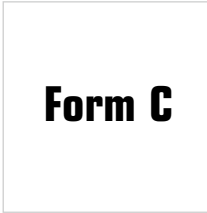

Universeller Einsatz

Universal Using

Technische Information

HSS-E = Hochleistungsschnell-Stahl Klasse E
Form C = 2-3 Gang Anschnitt für Durchgangs- und Sacklöcher
DIN 374 • Für metrisches ISO-Gewinde DIN 13, Toleranz 6H

Technical Information

HSS-E = High-speed-steel E-class
Form C = 2-3 pitch chamfer for through holes and blind holes
DIN 374 • For metric ISO-thread DIN 13, tolerance 6H

Anwendung

Zum Schneiden von Innengewinden.

Application

For cutting internal threads.

F = Artikel für Kabelverschraubungen
F = Tools for cable connections

Mf	mm	mm	mm	mm	mm	mm	CODE	€
F Mf 6,0	0,75	5,25	14	80	4,5	3,4	02551	
Mf 8,0	0,75	7,25	19	80	6,0	4,9	02552	
F Mf 8,0	1,00	7,00	22	90	6,0	4,9	02553	
F Mf 10,0	1,00	9,00	16	90	7,0	5,5	02554	
Mf 10,0	1,25	8,75	24	100	7,0	5,5	02589	
Mf 12,0	1,00	11,00	22	100	9,0	7,0	02555	
Mf 12,0	1,25	10,75	22	100	9,0	7,0	02590	
F Mf 12,0	1,50	10,50	22	100	9,0	7,0	02556	
Mf 14,0	1,00	13,00	22	100	11,0	9,0	02557	
Mf 14,0	1,25	12,75	22	100	11,0	9,0	02558	
Mf 14,0	1,50	12,50	22	100	11,0	9,0	02559	
Mf 16,0	1,00	15,00	22	100	12,0	9,0	02560	
F Mf 16,0	1,50	14,50	22	100	12,0	9,0	02561	
Mf 18,0	1,00	17,00	22	110	14,0	11,0	02562	
Mf 18,0	1,50	16,50	25	110	14,0	11,0	02563	
Mf 18,0	2,00	16,00	34	125	14,0	11,0	02564	
Mf 20,0	1,00	19,00	25	125	16,0	12,0	02565	
F Mf 20,0	1,50	18,50	25	125	16,0	12,0	02566	
Mf 20,0	2,00	18,00	34	140	16,0	12,0	02567	
Mf 22,0	1,00	21,00	25	125	18,0	14,5	02568	
Mf 22,0	1,50	20,50	25	125	18,0	14,5	02569	
Mf 22,0	2,00	20,00	34	140	18,0	14,5	02570	
Mf 24,0	1,00	23,00	28	140	18,0	14,5	02571	
Mf 24,0	1,50	22,50	28	140	18,0	14,5	02572	
Mf 24,0	2,00	22,00	28	140	18,0	14,5	02573	
F Mf 25,0	1,50	23,50	28	140	18,0	14,5	02591	
Mf 26,0	1,50	24,50	28	140	18,0	14,5	02574	
Mf 27,0	2,00	25,00	28	140	20,0	16,0	02575	
Mf 28,0	1,50	26,50	28	150	22,0	18,0	02576	
Mf 30,0	1,50	28,50	28	150	22,0	18,0	02577	
Mf 30,0	2,00	28,00	28	150	22,0	18,0	02578	
F Mf 32,0	1,50	30,50	28	150	22,0	18,0	02579	
Mf 35,0	1,50	33,50	30	170	28,0	22,0	02580	
Mf 36,0	1,50	34,50	28	170	28,0	22,0	02581	
Mf 38,0	1,50	36,50	28	170	28,0	22,0	02582	
F Mf 40,0	1,50	38,50	30	170	32,0	24,0	02583	
Mf 42,0	1,50	40,50	30	170	32,0	24,0	02584	
Mf 45,0	1,50	43,50	32	180	36,0	29,0	02585	
Mf 48,0	1,50	46,50	32	190	36,0	29,0	02586	
F Mf 50,0	1,50	48,50	32	190	36,0	29,0	02587	
Mf 52,0	1,50	50,50	32	190	40,0	32,0	02588	
F Mf 63,0	1,50	61,50	32	220	40,0	35,0	02592	

Maschinengewindebohrer DIN 5156

Machine Taps DIN 5156

BSP Whitworth-Rohrgewinde (G) | BSP Whitworth pipe thread (G)

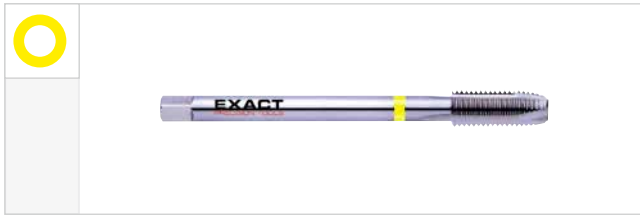

Universeller Einsatz

Technische Information

HSS-E = Hochleistungsschnell-Stahl Klasse E
Form B = 4-5 Gang Anschnitt mit Schälanschnitt für Durchgangslöcher
DIN 5156 • Für Whitworth-Rohrgewinde (G) DIN 259 ISO 228 / Teil 1

Anwendung

Zum Schneiden von Innengewinden.



HSS-E

Form B

Universal Using

Technical Information

HSS-E = High-speed-steel E-class
Form B = 4-5 pitch chamfer, spiral point for through holes
DIN 5156 • For Whitworth pipe thread DIN 259 ISO 228 / Part 1

Application

For cutting internal threads.

G BSP	mm	mm	mm	mm	mm	mm	mm	CODE	€
1/8	28	8,70	20	90	8,0	6,2	02721		
1/4	19	11,75	20	100	11,0	9,0	02722		
3/8	19	15,25	22	100	12,0	9,0	02723		
1/2	14	19,00	25	140	16,0	12,0	02724		
5/8	14	21,00	25	140	18,0	14,5	02725		
3/4	14	24,50	30	140	20,0	16,0	02726		
7/8	14	28,25	30	160	22,0	18,0	02727		
1	11	30,50	36	170	25,0	20,0	02728		

Weitere Abmessungen auf Anfrage lieferbar | Other sizes available on request

Einsatz GELBRING Application YELLOW RING																	
Baustahl	Baustahl	Auto- matenstahl	Ver- gütungs- stahl	Legierter Stahl	Stahl gehärtet	VA Stahl	VA Stahl	Werk- zeugstahl	Guss	Kupfer	Alu + Legierung	Uni	Schneidöl	Emulsion	Minimal Schmie- rung	Trocken- bearbei- tung	Pressluft
Structural steel	Structural steel	Free- cutting steel	Tempered steel	Alloyed steel	Hardened steel	VA steel	VA steel	Tool steel	Cast iron	Copper	Aluminium + alloy	Uni	Cutting oil	Emulsion	Minimum lubrication	Dry machining	Com- pressed air
≤ 500 N/ mm ²	> 500 N/ mm ²	≤ 1000 N/ mm ²	≤ 1000 N/ mm ²	≤ 1200 N/ mm ²	40 - 60 HRC	≤ 850 N/ mm ²	> 850 N/ mm ²	≤ 1000 N/ mm ²	≤ 300 HB	≤ 400 N/ mm ²	≤ 450 N/ mm ²						
●	●	●	○					○		○	○		●	●	●		

● empfohlen | recommended ○ bedingt geeignet | partly suitable

Maschinengewindebohrer DIN 5156

Machine Taps DIN 5156

EXACT
PRÄZISIONSWERKZEUGE

BSP Whitworth-Rohrgewinde (G) | BSP Whitworth pipe thread (G)



Technische Information

HSS-E = Hochleistungsschnell-Stahl Klasse E
 35° RSP = 2-3 Gang Anschnitt, 35° Rechtsspirale, für Sacklöcher
 DIN 5156 • Für Whitworth-Rohrgewinde (G) DIN 259 ISO 228 / Teil 1

Anwendung

Zum Schneiden von Innengewinden.

Technical Information

HSS-E = High-speed-steel E-class
 35° RSP = 2-3 pitch chamfer, with 35° spiral flute, for blind holes
 DIN 5156 • For Whitworth pipe thread DIN 259 ISO 228 / Part 1

Application

For cutting internal threads.

G BSP	mm	mm	mm	mm	mm	mm	mm	CODE	€
1/8	28	8,70	20	90	8,0	6,2	02760		
1/4	19	11,75	20	100	11,0	9,0	02761		
3/8	19	15,25	22	100	12,0	9,0	02762		
1/2	14	19,00	25	140	16,0	12,0	02763		
5/8	14	21,00	25	140	18,0	14,5	02764		
3/4	14	24,50	30	140	20,0	16,0	02765		
7/8	14	28,25	30	160	22,0	18,0	02766		
1	11	30,50	36	170	25,0	20,0	02767		

Weitere Abmessungen auf Anfrage lieferbar | Other sizes available on request

Einsatz GELBRING Application YELLOW RING																	
Baustahl	Baustahl	Auto- matenstahl	Ver- gütungs- stahl	Legierter Stahl	Stahl gehärtet	VA Stahl	VA Stahl	Werk- zeugstahl	Guss	Kupfer	Alu + Legierung	Uni	Schneidöl	Emulsion	Minimal Schmie- rung	Trocken- bearbei- tung	Pressluft
Structural steel	Structural steel	Free- cutting steel	Tempered steel	Alloyed steel	Hardened steel	VA steel	VA steel	Tool steel	Cast iron	Copper	Aluminium + alloy	Uni	Cutting oil	Emulsion	Minimum lubrication	Dry machining	Com- pressed air
≤ 500 N/ mm ²	> 500 N/ mm ²	≤ 1000 N/ mm ²	≤ 1000 N/ mm ²	≤ 1200 N/ mm ²	40 - 60 HRC	≤ 850 N/ mm ²	> 850 N/ mm ²	≤ 1000 N/ mm ²	≤ 300 HB	≤ 400 N/ mm ²	≤ 450 N/ mm ²						
●	●	●	○					○		○	○		●	●	●		

● empfohlen | recommended ○ bedingt geeignet | partly suitable

Maschinengewindebohrer DIN 5156

Machine Taps DIN 5156

BSP Whitworth-Rohrgewinde (G) | BSP Whitworth pipe thread (G)



Universeller Einsatz



HSS-E

Form C

Universal Using

Technische Information

HSS-E = Hochleistungsschnell-Stahl Klasse E
Form C = 2-3 Gang Anschnitt für Durchgangs- und Sacklöcher
DIN 5156 • Für Whitworth-Rohrgewinde (G) DIN 259 ISO 228 / Teil 1

Anwendung

Zum Schneiden von Innengewinden.

Technical Information

HSS-E = High-speed-steel E-class
Form C = 2-3 pitch chamfer for through holes and blind holes
DIN 5156 • For Whitworth pipe thread DIN 259 ISO 228 / Part 1

Application

For cutting internal threads.

G BSP	mm	mm	mm	mm	mm	mm	mm	CODE	€
1/8	28	8,70	20	90	8,0	6,2	02741		
1/4	19	11,75	20	100	11,0	9,0	02742		
3/8	19	15,25	22	100	12,0	9,0	02743		
1/2	14	19,00	25	140	16,0	12,0	02744		
5/8	14	21,00	25	140	18,0	14,5	02745		
3/4	14	24,50	30	140	20,0	16,0	02746		
7/8	14	28,25	30	160	22,0	18,0	02747		
1	11	30,50	36	170	25,0	20,0	02748		

Weitere Abmessungen auf Anfrage lieferbar | Other sizes available on request

Einsatz GELBRING Application YELLOW RING																	
Baustahl	Baustahl	Auto- matenstahl	Ver- gütungs- stahl	Legierter Stahl	Stahl gehärtet	VA Stahl	VA Stahl	Werk- zeugstahl	Guss	Kupfer	Alu + Legierung	Uni	Schneidöl	Emulsion	Minimal Schmie- rung	Trocken- bearbei- tung	Pressluft
Structural steel	Structural steel	Free- cutting steel	Tempered steel	Alloyed steel	Hardened steel	VA steel	VA steel	Tool steel	Cast iron	Copper	Aluminium + alloy	Uni	Cutting oil	Emulsion	Minimum lubrication	Dry machining	Com- pressed air
≤ 500 N/ mm ²	> 500 N/ mm ²	≤ 1000 N/ mm ²	≤ 1000 N/ mm ²	≤ 1200 N/ mm ²	40 - 60 HRC	≤ 850 N/ mm ²	> 850 N/ mm ²	≤ 1000 N/ mm ²	≤ 300 HB	≤ 400 N/ mm ²	≤ 450 N/ mm ²						
●	●	●	○					○		○	○		●	●	●		

● empfohlen | recommended ○ bedingt geeignet | partly suitable

Maschinengewindebohrer DIN 2182/2183

Machine Taps DIN 2182/2183

EXACT
PRÄZISIONSWERKZEUGE

UNC | UNC

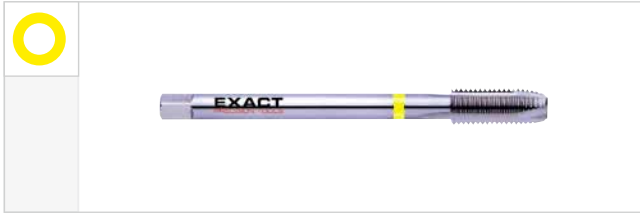

Universeller Einsatz



Universal Using

Technische Information

HSS-E = Hochleistungsschnell-Stahl Klasse E
Form B = 4-5 Gang Anschnitt mit Schälanschnitt für Durchgangslöcher
DIN 2182 / 2183 • Für UNC-Gewinde (Unified-Grobgewinde), Toleranz 2B

Technical Information

HSS-E = High-speed-steel E-class
Form B = 4-5 pitch chamfer, spiral point for through holes
DIN 2182 / 2183 • For UNC thread (Unified coarse thread), tolerance 2B

Anwendung

Zum Schneiden von Innengewinden.

Application

For cutting internal threads.

UNC	mm	mm	mm	mm	mm	mm	CODE	€
mit verstärktem Schaft - DIN 2182								
1/4	20	5,10	22	80	7,0	5,5	03031	
5/16	18	6,50	25	90	8,0	6,2	03032	
3/8	16	7,90	28	100	9,0	7,0	03033	
mit durchfallendem Schaft - DIN 2183								
7/16	14	9,30	28	100	8,0	6,2	03034	
1/2	13	10,80	32	110	9,0	7,0	03035	
9/16	12	12,30	32	110	11,0	9,0	03036	
5/8	11	13,50	32	110	12,0	9,0	03037	
3/4	10	16,50	36	125	14,0	11,0	03038	
7/8	9	19,50	40	140	18,0	14,5	03039	
1	8	22,25	45	160	20,0	16,0	03040	

Weitere Abmessungen auf Anfrage lieferbar | Other sizes available on request

Einsatz GELBRING Application YELLOW RING																	
Baustahl	Baustahl	Auto- matenstahl Free- cutting steel	Ver- gütungs- stahl Tempered steel	Legierter Stahl Alloyed steel	Stahl gehärtet Hardened steel	VA Stahl	VA Stahl	Werk- zeugstahl Tool steel	Guss	Kupfer	Alu + Legierung Aluminium + alloy	Uni	Schneidöl	Emulsion	Minimal Schmie- rung Minimum lubrication	Trocken- bearbei- tung Dry machining	Pressluft
≤ 500 N/ mm ²	> 500 N/ mm ²	≤ 1000 N/ mm ²	≤ 1000 N/ mm ²	≤ 1200 N/ mm ²	40 - 60 HRC	≤ 850 N/ mm ²	> 850 N/ mm ²	≤ 1000 N/ mm ²	≤ 300 HB	≤ 400 N/ mm ²	≤ 450 N/ mm ²		Cutting oil	Emulsion			Com- pressed air
●	●	●	○					○		○	○		●	●	●		

● empfohlen | recommended ○ bedingt geeignet | partly suitable

Maschinengewindebohrer DIN 2182/2183

Machine Taps DIN 2182/2183

UNC | UNC



Universeller Einsatz



Universal Using

Technische Information

HSS-E = Hochleistungsschnell-Stahl Klasse E
35° RSP = 2-3 Gang Anschnitt, 35° Rechtsspirale, für Sacklöcher
DIN 2182 / 2183 • Für UNC-Gewinde (Unified-Grobgewinde), Toleranz 2B

Anwendung

Zum Schneiden von Innengewinden.

Technical Information

HSS-E = High-speed-steel E-class
35° RSP = 2-3 pitch chamfer, with 35° spiral flute, for blind holes
DIN 2182 / 2183 • For UNC thread (Unified coarse thread), tolerance 2B

Application

For cutting internal threads.

UNC	mm	mm	mm	mm	mm	mm	mm	CODE	€
mit verstärktem Schaft - DIN 2182									
1/4	20	5,10	22	80	7,0	5,5	03081		
5/16	18	6,50	25	90	8,0	6,2	03082		
3/8	16	7,90	28	100	9,0	7,0	03083		
mit durchfallendem Schaft - DIN 2183									
7/16	14	9,30	28	100	8,0	6,2	03084		
1/2	13	10,80	32	110	9,0	7,0	03085		
9/16	12	12,30	32	110	11,0	9,0	03086		
5/8	11	13,50	32	110	12,0	9,0	03087		
3/4	10	16,50	36	125	14,0	11,0	03088		
7/8	9	19,50	40	140	18,0	14,5	03089		
1	8	22,25	45	160	20,0	16,0	03090		

Weitere Abmessungen auf Anfrage lieferbar | Other sizes available on request

Einsatz GELBRING Application YELLOW RING																	
Baustahl	Baustahl	Auto- matenstahl	Ver- gütungs- stahl	Legierter Stahl	Stahl gehärtet	VA Stahl	VA Stahl	Werk- zeugstahl	Guss	Kupfer	Alu + Legierung	Uni	Schneidöl	Emulsion	Minimal Schmie- rung	Trocken- bearbei- tung	Pressluft
Structural steel	Structural steel	Free- cutting steel	Tempered steel	Alloyed steel	Hardened steel	VA steel	VA steel	Tool steel	Cast iron	Copper	Aluminium + alloy	Uni	Cutting oil	Emulsion	Minimum lubrication	Dry machining	Com- pressed air
≤ 500 N/ mm ²	> 500 N/ mm ²	≤ 1000 N/ mm ²	≤ 1000 N/ mm ²	≤ 1200 N/ mm ²	40 - 60 HRC	≤ 850 N/ mm ²	> 850 N/ mm ²	≤ 1000 N/ mm ²	≤ 300 HB	≤ 400 N/ mm ²	≤ 450 N/ mm ²						
●	●	●	○					○		○	○		●	●	●		

● empfohlen | recommended ○ bedingt geeignet | partly suitable

Maschinengewindebohrer DIN 2182/2183

Machine Taps DIN 2182/2183

EXACT
PRÄZISIONSWERKZEUGE

UNC | UNC



Universeller Einsatz



Universal Using

Technische Information

HSS-E = Hochleistungsschnell-Stahl Klasse E
 Form C = 2-3 Gang Anschnitt für Durchgangs- und Sacklöcher
 DIN 2182 / 2183 • Für UNC-Gewinde (Unified-Grobgewinde), Toleranz 2B

Technical Information

HSS-E = High-speed-steel E-class
 Form C = 2-3 pitch chamfer for through holes and blind holes
 DIN 2182 / 2183 • For UNC thread (Unified coarse thread), tolerance 2B

Anwendung

Zum Schneiden von Innengewinden.

Application

For cutting internal threads.

UNC	mm	mm	mm	mm	mm	mm	CODE	€
mit verstärktem Schaft - DIN 2182								
1/4	20	5,10	22	80	7,0	5,5	03061	
5/16	18	6,50	25	90	8,0	6,2	03062	
3/8	16	7,90	28	100	9,0	7,0	03063	
mit durchfallendem Schaft - DIN 2183								
7/16	14	9,30	28	100	8,0	6,2	03064	
1/2	13	10,80	32	110	9,0	7,0	03065	
9/16	12	12,30	32	110	11,0	9,0	03066	
5/8	11	13,50	32	110	12,0	9,0	03067	
3/4	10	16,50	36	125	14,0	11,0	03068	
7/8	9	19,50	40	140	18,0	14,5	03069	
1	8	22,25	45	160	20,0	16,0	03070	

Weitere Abmessungen auf Anfrage lieferbar | Other sizes available on request

Einsatz GELBRING Application YELLOW RING																	
Baustahl	Baustahl	Auto- matenstahl Free- cutting steel	Vergü- tungs- stahl Tempered steel	Legierter Stahl Alloyed steel	Stahl gehärtet Hardened steel	VA Stahl	VA Stahl	Werk- zeugstahl Tool steel	Guss	Kupfer	Alu + Legierung Aluminium + alloy	Uni	Schneidöl	Emulsion	Minimal Schmie- rung Minimum lubrication	Trocken- bearbei- tung Dry machining	Pressluft
≤ 500 N/ mm ²	> 500 N/ mm ²	≤ 1000 N/ mm ²	≤ 1000 N/ mm ²	≤ 1200 N/ mm ²	40 - 60 HRC	≤ 850 N/ mm ²	> 850 N/ mm ²	≤ 1000 N/ mm ²	≤ 300 HB	≤ 400 N/ mm ²	≤ 450 N/ mm ²		Cutting oil	Emulsion			Com- pressed air
●	●	●	○					○		○	○		●	●	●		

● empfohlen | recommended ○ bedingt geeignet | partly suitable

Maschinengewindebohrer DIN 2182/2183

Machine Taps DIN 2182/2183

UNF | UNF



Universeller Einsatz



Universal Using

Technische Information

HSS-E = Hochleistungsschnell-Stahl Klasse E
Form B = 4-5 Gang Anschnitt mit Schälanschnitt für Durchgangslöcher
DIN 2182 / 2183 • Für UNF-Gewinde (Unified-Feingewinde), Toleranz 2B

Anwendung

Zum Schneiden von Innengewinden.

Technical Information

HSS-E = High-speed-steel E-class
Form B = 4-5 pitch chamfer, spiral point for through holes
DIN 2182 / 2183 • For UNF thread (Unified fine thread), tolerance 2B

Application

For cutting internal threads.

UNF	mm	mm	mm	mm	mm	mm	mm	CODE	€
mit verstärktem Schaft - DIN 2182									
1/4	28	5,50	22	80	7,0	5,5	03181		
5/16	24	6,90	25	90	8,0	6,2	03182		
3/8	24	8,50	38	100	9,0	7,0	03183		
mit durchfallendem Schaft - DIN 2183									
7/16	20	9,90	28	100	8,0	6,2	03184		
1/2	20	11,50	32	110	9,0	7,0	03185		
9/16	18	13,00	32	110	11,0	9,0	03186		
5/8	18	14,60	32	110	12,0	9,0	03187		
3/4	16	17,50	36	125	14,0	11,0	03188		
7/8	14	20,50	40	140	18,0	14,5	03189		
1	12	23,40	45	160	20,0	16,0	03190		

Weitere Abmessungen auf Anfrage lieferbar | Other sizes available on request

Einsatz GELBRING Application YELLOW RING																		
Baustahl	Baustahl	Auto- matenstahl	Ver- gütungs- stahl	Legierter Stahl	Stahl gehärtet	VA Stahl	VA Stahl	Werk- zeugstahl	Guss	Kupfer	Alu + Legierung	Uni	Schneidöl	Emulsion	Minimal Schmie- rung	Trocken- bearbei- tung	Pressluft	
Structural steel	Structural steel	Free- cutting steel	Tempered steel	Alloyed steel	Hardened steel	VA steel	VA steel	Tool steel	Cast iron	Copper	Aluminium + alloy	Uni	Cutting oil	Emulsion	Minimum lubrication	Dry machining	Com- pressed air	
≤ 500 N/ mm ²	> 500 N/ mm ²	≤ 1000 N/ mm ²	≤ 1000 N/ mm ²	≤ 1200 N/ mm ²	40 - 60 HRC	≤ 850 N/ mm ²	> 850 N/ mm ²	≤ 1000 N/ mm ²	≤ 300 HB	≤ 400 N/ mm ²	≤ 450 N/ mm ²							
●	●	●	○					○		○	○		●	●	●			

● empfohlen | recommended ○ bedingt geeignet | partly suitable

UNF | UNF

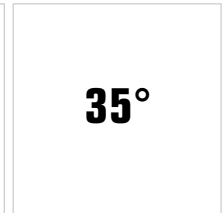

Universeller Einsatz

Universal Using

Technische Information

HSS-E = Hochleistungsschnell-Stahl Klasse E
35° RSP = 2-3 Gang Anschnitt, 35° Rechtsspirale, für Sacklöcher
DIN 2182 / 2183 • Für UNF-Gewinde (Unified-Feingewinde), Toleranz 2B

Technical Information

HSS-E = High-speed-steel E-class
35° RSP = 2-3 pitch chamfer, with 35° spiral flute, for blind holes
DIN 2182 / 2183 • For UNF thread (Unified fine thread), tolerance 2B

Anwendung

Zum Schneiden von Innengewinden.

Application

For cutting internal threads.

UNF	mm	mm	mm	mm	mm	mm	mm	CODE	€
mit verstärktem Schaft - DIN 2182									
1/4	28	5,50	22	80	7,0	5,5	03231		
5/16	24	6,90	25	90	8,0	6,2	03232		
3/8	24	8,50	38	100	9,0	7,0	03233		
mit durchfallendem Schaft - DIN 2183									
7/16	20	9,90	28	100	8,0	6,2	03234		
1/2	20	11,50	32	110	9,0	7,0	03235		
9/16	18	13,00	32	110	11,0	9,0	03236		
5/8	18	14,60	32	110	12,0	9,0	03237		
3/4	16	17,50	36	125	14,0	11,0	03238		
7/8	14	20,50	40	140	18,0	14,5	03239		
1	12	23,40	45	160	20,0	16,0	03240		

Weitere Abmessungen auf Anfrage lieferbar | Other sizes available on request

Einsatz GELBRING Application YELLOW RING																	
Baustahl	Baustahl	Auto- matenstahl Free- cutting steel	Ver- gütungs- stahl Tempered steel	Legierter Stahl Alloyed steel	Stahl gehärtet Hardened steel	VA Stahl	VA Stahl	Werk- zeugstahl Tool steel	Guss	Kupfer	Alu + Legierung Aluminium + alloy	Uni	Schneidöl	Emulsion	Minimal Schmie- rung Minimum lubrication	Trocken- bearbei- tung Dry machining	Pressluft
Structural steel	Structural steel	Free- cutting steel	Tempered steel	Alloyed steel	Hardened steel	VA steel	VA steel	Tool steel	Cast iron	Copper	Aluminium + alloy	Uni	Cutting oil	Emulsion	Minimum lubrication	Dry machining	Com- pressed air
≤ 500 N/ mm ²	> 500 N/ mm ²	≤ 1000 N/ mm ²	≤ 1000 N/ mm ²	≤ 1200 N/ mm ²	40 - 60 HRC	≤ 850 N/ mm ²	> 850 N/ mm ²	≤ 1000 N/ mm ²	≤ 300 HB	≤ 400 N/ mm ²	≤ 450 N/ mm ²						
●	●	●	○					○		○	○		●	●	●		

● empfohlen | recommended ○ bedingt geeignet | partly suitable

Maschinengewindebohrer DIN 2182/2183

Machine Taps DIN 2182/2183

EXACT
PRÄZISIONSWERKZEUGE

UNF | UNF



Universeller Einsatz



Universal Using

Technische Information

HSS-E = Hochleistungsschnell-Stahl Klasse E
Form C = 2-3 Gang Anschnitt für Durchgangs- und Sacklöcher
DIN 2182 / 2183 • Für UNF-Gewinde (Unified-Feingewinde), Toleranz 2B

Anwendung

Zum Schneiden von Innengewinden.

Technical Information

HSS-E = High-speed-steel E-class
Form C = 2-3 pitch chamfer for through holes and blind holes
DIN 2182 / 2183 • For UNF thread (Unified fine thread), tolerance 2B

Application

For cutting internal threads.

UNF	mm	mm	mm	mm	mm	mm	mm	CODE	€
mit verstärktem Schaft - DIN 2182									
1/4	28	5,50	22	80	7,0	5,5	03211		
5/16	24	6,90	25	90	8,0	6,2	03212		
3/8	24	8,50	38	100	9,0	7,0	03213		
mit durchfallendem Schaft - DIN 2183									
7/16	20	9,90	28	100	8,0	6,2	03214		
1/2	20	11,50	32	110	9,0	7,0	03215		
9/16	18	13,00	32	110	11,0	9,0	03216		
5/8	18	14,60	32	110	12,0	9,0	03217		
3/4	16	17,50	36	125	14,0	11,0	03218		
7/8	14	20,50	40	140	18,0	14,5	03219		
1	12	23,40	45	160	20,0	16,0	03220		

Weitere Abmessungen auf Anfrage lieferbar | Other sizes available on request

Einsatz GELBRING Application YELLOW RING																	
Baustahl	Baustahl	Auto- matenstahl	Ver- gütungs- stahl	Legierter Stahl	Stahl gehärtet	VA Stahl	VA Stahl	Werk- zeugstahl	Guss	Kupfer	Alu + Legierung	Uni	Schneidöl	Emulsion	Minimal Schmie- rung	Trocken- bearbei- tung	Pressluft
Structural steel	Structural steel	Free- cutting steel	Tempered steel	Alloyed steel	Hardened steel	VA steel	VA steel	Tool steel	Cast iron	Copper	Aluminium + alloy	Uni	Cutting oil	Emulsion	Minimum lubrication	Dry machining	Com- pressed air
≤ 500 N/ mm ²	> 500 N/ mm ²	≤ 1000 N/ mm ²	≤ 1000 N/ mm ²	≤ 1200 N/ mm ²	40 - 60 HRC	≤ 850 N/ mm ²	> 850 N/ mm ²	≤ 1000 N/ mm ²	≤ 300 HB	≤ 400 N/ mm ²	≤ 450 N/ mm ²						
●	●	●	○					○		○	○		●	●	●		

● empfohlen | recommended ○ bedingt geeignet | partly suitable

Maschinengewindebohrer DIN 371 / 376

Machine Taps DIN 371 / 376



Metrisch | Metric

M

HSS-E

Form B

○
Stähle über 1000 N/mm²

M

HSS-E

35°

○
Steel over 1000 N/mm²

Technische Information

HSS-E = Hochleistungsschnell-Stahl Klasse E
 Form B = 5 Gang Anschnitt mit Schälanschnitt für Durchgangslöcher
 35° RSP = 2 Gang Anschnitt für Sacklöcher
 DIN 371 / 376 • Für metrisches ISO-Gewinde DIN 13, Toleranz 6H

Anwendung

Zum Schneiden von Innengewinden.

Technical Information

HSS-E = High-speed-steel E-class
 Form B = 5-pitch chamfer, spiral point for through holes
 35° RSP = 2-pitch chamfer with 35° spiral flute for blind holes
 DIN 371 / 376 • For metric ISO-thread DIN 13, tolerance 6H

Application

For cutting internal threads.

M	mm	mm	mm	mm	mm	mm	CODE FORM B	€	CODE 35° RSP	€
mit verstärktem Schaft - DIN 371										
M 3,0	0,50	2,50	11	56	3,5	2,7	42331		43681	
M 4,0	0,70	3,30	13	63	4,5	3,4	42332		43682	
M 5,0	0,80	4,20	16	70	6,0	4,9	42333		43683	
M 6,0	1,00	5,00	19	80	6,0	4,9	42334		43684	
M 8,0	1,25	6,75	22	90	8,0	6,2	42335		43685	
M 10,0	1,50	8,50	24	100	10,0	8,0	42336		43686	
mit durchfallendem Schaft - DIN 376										
M 12,0	1,75	10,25	29	110	9,0	7,0	42337		43687	
M 14,0	2,00	12,00	30	110	11,0	9,0	42338		43688	
M 16,0	2,00	14,00	32	110	12,0	9,0	42339		43689	
M 18,0	2,50	15,50	34	125	14,0	11,0	42340		43690	
M 20,0	2,50	17,50	34	140	16,0	12,0	42341		43691	
M 22,0	2,50	19,50	34	140	18,0	14,5	42342		43692	
M 24,0	3,00	21,00	38	160	18,0	14,5	42343		43693	

Einsatz ROTRING | Application RED RING

Baustahl	Baustahl	Auto- matenstahl Free- cutting steel	Ver- gütungs- stahl Tempered steel	Legierter Stahl Alloyed steel	Stahl gehärtet Hardened steel	VA Stahl	VA Stahl	Werk- zeugstahl Tool steel	Guss	Kupfer	Alu + Legierung Aluminium + alloy	Uni	Schneidöl	Emulsion	Minimal Schmie- rung Minimum lubrication	Trocken- bearbei- tung Dry machining	Pressluft
≤ 500 N/mm ²	> 500 N/mm ²	≤ 1000 N/mm ²	≤ 1000 N/mm ²	≤ 1200 N/mm ²	40 - 60 HRC	≤ 850 N/mm ²	> 850 N/mm ²	≤ 1000 N/mm ²	≤ 300 HB	≤ 400 N/mm ²	≤ 450 N/mm ²		Cutting oil	Emulsion	Minimum lubrication	Dry machining	Compressed air
●	●	●	●	●				●					●	●	●		

● empfohlen | recommended ○ bedingt geeignet | partly suitable



Maschinengewindebohrer-Sets Machine Tap Sets

EXACT
PRÄZISIONSWERKZEUGE

Metrisch | Metric

Maschinengewindebohrer • Machine Taps

M	
HSS-E	
Form B	
Stähle über 1000 N/mm²	

M	
HSS-E	
35°	
Steel over 1000 N/mm²	

 	 FORM B	 SET
Maschinengewindebohrer Machine Taps: M3 - M4 - M5 - M6 - M8 - M10 - M12		42345

 	 35° RSP	 SET
Maschinengewindebohrer Machine Taps: M3 - M4 - M5 - M6 - M8 - M10 - M12		43694

M	
HSS-E	
Form B	
Stähle über 1000 N/mm²	

M	
HSS-E	
35°	
Stähle über 1000 N/mm²	

 	 FORM B	 SET
Maschinengewindebohrer Machine Taps: M3 - M4 - M5 - M6 - M8 - M10 - M12 + Kernlochbohrer Twist Drills: 2,5 - 3,3 - 4,2 - 5 - 6,8 - 8,5 - 10,2		43695

 	 35° RSP	 SET
Maschinengewindebohrer Machine Taps: M3 - M4 - M5 - M6 - M8 - M10 - M12 + Kernlochbohrer Twist Drills: 2,5 - 3,3 - 4,2 - 5 - 6,8 - 8,5 - 10,2		43696

Maschinengewindebohrer DIN 374

Machine Taps DIN 374

Metrisch fein | Metric fine



Stähle über 1000 N/mm²

Steel over 1000 N/mm²

Technische Information

HSS-E = Hochleistungsschnell-Stahl Klasse E
 Form B = 4-5 Gang Anschnitt mit Schälanschnitt für Durchgangslöcher
 DIN 374 • Für metrisches ISO-Gewinde DIN 13, Toleranz 6H

Technical Information

HSS-E = High-speed-steel E-class
 Form B = 4-5 pitch chamfer, spiral point for through holes
 DIN 374 • For metric ISO-thread DIN 13, tolerance 6H

Anwendung

Zum Schneiden von Innengewinden.

Application

For cutting internal threads.

Mf	mm	mm	mm	mm	mm	mm	CODE	€
Mf 6,0	0,75	5,25	14	80	4,5	3,4	42346	
Mf 8,0	0,75	7,25	19	80	6,0	4,9	42347	
Mf 8,0	1,00	7,00	22	90	6,0	4,9	42348	
Mf 10,0	1,00	9,00	16	90	7,0	5,5	42349	
Mf 10,0	1,25	8,75	24	100	7,0	5,5	42350	
Mf 12,0	1,00	11,00	22	100	9,0	7,0	42351	
Mf 12,0	1,25	10,75	22	100	9,0	7,0	42352	
Mf 12,0	1,50	10,50	22	100	9,0	7,0	42353	
Mf 14,0	1,00	13,00	22	100	11,0	9,0	42354	
Mf 14,0	1,25	12,75	22	100	11,0	9,0	42355	
Mf 14,0	1,50	12,50	22	100	11,0	9,0	42356	
Mf 16,0	1,00	15,00	22	100	12,0	9,0	42357	
Mf 16,0	1,50	14,50	22	100	12,0	9,0	42358	
Mf 18,0	1,00	17,00	22	110	14,0	11,0	42359	
Mf 18,0	1,50	16,50	25	110	14,0	11,0	42360	
Mf 18,0	2,00	16,00	34	125	14,0	11,0	42361	
Mf 20,0	1,00	19,00	25	125	16,0	12,0	42362	
Mf 20,0	1,50	18,50	25	125	16,0	12,0	42363	
Mf 20,0	2,00	18,00	34	140	16,0	12,0	42364	
Mf 22,0	1,00	21,00	25	125	18,0	14,5	42365	
Mf 22,0	1,50	20,50	25	125	18,0	14,5	42366	
Mf 22,0	2,00	20,00	34	140	18,0	14,5	42367	
Mf 24,0	1,00	23,00	28	140	18,0	14,5	42368	
Mf 24,0	1,50	22,50	28	140	18,0	14,5	42369	

Einsatz ROTRING | Application RED RING

Baustahl	Baustahl	Auto- matenstahl	Ver- gütungs- stahl	Legierter Stahl	Stahl gehärtet	VA Stahl	VA Stahl	Werk- zeugstahl	Guss	Kupfer	Alu + Legierung	Uni	Schneidöl	Emulsion	Minimal Schmie- rung	Trocken- bearbei- tung	Pressluft
Structural steel	Structural steel	Free- cutting steel	Tempered steel	Alloyed steel	Hardened steel	VA steel	VA steel	Tool steel	Cast iron	Copper	Aluminium + alloy	Uni	Cutting oil	Emulsion	Minimum lubrication	Dry machining	Com- pressed air
≤ 500 N/ mm ²	> 500 N/ mm ²	≤ 1000 N/ mm ²	≤ 1000 N/ mm ²	≤ 1200 N/ mm ²	40 - 60 HRC	≤ 850 N/ mm ²	> 850 N/ mm ²	≤ 1000 N/ mm ²	≤ 300 HB	≤ 400 N/ mm ²	≤ 450 N/ mm ²						
●	●	●	●	●				●					●	●	●		

● empfohlen | recommended ○ bedingt geeignet | partly suitable

Maschinengewindebohrer DIN 374

Machine Taps DIN 374

EXACT
PRÄZISIONSWERKZEUGE

Metrisch fein | Metric fine



Stähle über 1000 N/mm²

Steel over 1000 N/mm²

Technische Information

HSS-E = Hochleistungsschnell-Stahl Klasse E
35° RSP = 2-3 Gang Anschnitt, 35° Rechtsspirale, für Sacklöcher
DIN 374 • Für metrisches ISO-Gewinde DIN 13, Toleranz 6H

Technical Information

HSS-E = High-speed-steel E-class
35° RSP = 2-3 pitch chamfer, with 35° spiral flute, for blind holes
DIN 374 • For metric ISO-thread DIN 13, tolerance 6H

Anwendung

Zum Schneiden von Innengewinden.

Application

For cutting internal threads.

Mf	mm	mm	mm	mm	mm	mm	CODE	€
Mf 6,0	0,75	5,25	14	80	4,5	3,4	43701	
Mf 8,0	0,75	7,25	19	80	6,0	4,9	43702	
Mf 8,0	1,00	7,00	22	90	6,0	4,9	43703	
Mf 10,0	1,00	9,00	16	90	7,0	5,5	43704	
Mf 10,0	1,25	8,75	24	100	7,0	5,5	43705	
Mf 12,0	1,00	11,00	22	100	9,0	7,0	43706	
Mf 12,0	1,25	10,75	22	100	9,0	7,0	43707	
Mf 12,0	1,50	10,50	22	100	9,0	7,0	43708	
Mf 14,0	1,00	13,00	22	100	11,0	9,0	43709	
Mf 14,0	1,25	12,75	22	100	11,0	9,0	43710	
Mf 14,0	1,50	12,50	22	100	11,0	9,0	43711	
Mf 16,0	1,00	15,00	22	100	12,0	9,0	43712	
Mf 16,0	1,50	14,50	22	100	12,0	9,0	43713	
Mf 18,0	1,00	17,00	22	110	14,0	11,0	43714	
Mf 18,0	1,50	16,50	25	110	14,0	11,0	43715	
Mf 18,0	2,00	16,00	34	125	14,0	11,0	43716	
Mf 20,0	1,00	19,00	25	125	16,0	12,0	43717	
Mf 20,0	1,50	18,50	25	125	16,0	12,0	43718	
Mf 20,0	2,00	18,00	34	140	16,0	12,0	43719	
Mf 22,0	1,00	21,00	25	125	18,0	14,5	43720	
Mf 22,0	1,50	20,50	25	125	18,0	14,5	43721	
Mf 22,0	2,00	20,00	34	140	18,0	14,5	43722	
Mf 24,0	1,00	23,00	28	140	18,0	14,5	43723	
Mf 24,0	1,50	22,50	28	140	18,0	14,5	43724	

Einsatz ROTRING Application RED RING																	
Baustahl	Baustahl	Auto- matenstahl	Ver- gütungs- stahl	Legierter Stahl	Stahl gehärtet	VA Stahl	VA Stahl	Werk- zeugstahl	Guss	Kupfer	Alu + Legierung	Uni	Schneidöl	Emulsion	Minimal Schmie- rung	Trocken- bearbei- tung	Pressluft
Structural steel	Structural steel	Free- cutting steel	Tempered steel	Alloyed steel	Hardened steel	VA steel	VA steel	Tool steel	Cast iron	Copper	Aluminium + alloy	Uni	Cutting oil	Emulsion	Minimum lubrication	Dry machining	Com- pressed air
≤ 500 N/ mm ²	> 500 N/ mm ²	≤ 1000 N/ mm ²	≤ 1000 N/ mm ²	≤ 1200 N/ mm ²	40 - 60 HRC	≤ 850 N/ mm ²	> 850 N/ mm ²	≤ 1000 N/ mm ²	≤ 300 HB	≤ 400 N/ mm ²	≤ 450 N/ mm ²						
●	●	●	●	●				●					●	●	●		

● empfohlen | recommended ○ bedingt geeignet | partly suitable

Maschinengewindebohrer • Machine Taps

Maschinengewindebohrer DIN 371 / 376

Machine Taps DIN 371 / 376

EXACT
PRÄZISIONSWERKZEUGE

Metrisch | Metric



Technische Information

HSS-E = Hochleistungsschnell-Stahl Klasse E
 Form B = 5 Gang Anschnitt mit Schälanschnitt für Durchgangslöcher
 35° RSP = 2 Gang Anschnitt für Sacklöcher
 DIN 371 / 376 • Für metrisches ISO-Gewinde DIN 13, Toleranz 6H

Anwendung

Zum Schneiden von Innengewinden.

Technical Information

HSS-E = High-speed-steel E-class
 Form B = 5-pitch chamfer, spiral point for through holes
 35° RSP = 2-pitch chamfer with 35° spiral flute for blind holes
 DIN 371 / 376 • For metric ISO-thread DIN 13, tolerance 6H

Application

For cutting internal threads.

M	mm	mm	mm	mm	mm	mm	mm	CODE FORM B	€	CODE 35° RSP	€
mit verstärktem Schaft - DIN 371											
M 3,0	0,50	2,50	11	56	3,5	2,7	42291		43641		
M 4,0	0,70	3,30	13	63	4,5	3,4	42292		43642		
M 5,0	0,80	4,20	16	70	6,0	4,9	42293		43643		
M 6,0	1,00	5,00	19	80	6,0	4,9	42294		43644		
M 8,0	1,25	6,75	22	90	8,0	6,2	42295		43645		
M 10,0	1,50	8,50	24	100	10,0	8,0	42296		43646		
mit durchfallendem Schaft - DIN 376											
M 12,0	1,75	10,25	29	110	9,0	7,0	42297		43647		
M 14,0	2,00	12,00	30	110	11,0	9,0	42298		43648		
M 16,0	2,00	14,00	32	110	12,0	9,0	42299		43649		
M 18,0	2,50	15,50	34	125	14,0	11,0	42300		43650		
M 20,0	2,50	17,50	34	140	16,0	12,0	42301		43651		
M 22,0	2,50	19,50	34	140	18,0	14,5	42302		43652		
M 24,0	3,00	21,00	38	160	18,0	14,5	42303		43653		

Einsatz BLAURING | Application BLUE RING

Baustahl	Baustahl	Auto- matenstahl Free- cutting steel	Ver- gütungs- stahl Tempered steel	Legierter Stahl Alloyed steel	Stahl gehärtet Hardened steel	VA Stahl VA steel	VA Stahl VA steel	Werk- zeugstahl Tool steel	Guss Cast iron	Kupfer Copper	Alu + Legierung Aluminium + alloy	Uni Uni	Schneidöl Cutting oil	Emulsion Emulsion	Minimal Schmie- rung Minimum lubrication	Trocken- bearbei- tung Dry machining	Pressluft Com- pressed air
≤ 500 N/mm ²	> 500 N/mm ²	≤ 1000 N/mm ²	≤ 1000 N/mm ²	≤ 1200 N/mm ²	40 - 60 HRC	≤ 850 N/mm ²	> 850 N/mm ²	≤ 1000 N/mm ²	≤ 300 HB	≤ 400 N/mm ²	≤ 450 N/mm ²						
						●	●						●	●	●		

● empfohlen | recommended ○ bedingt geeignet | partly suitable



Maschinengewindebohrer-Sets Machine Tap Sets

EXACT
PRÄZISIONSWERKZEUGE

Metrisch | **Metric**

Maschinengewindebohrer • Machine Taps

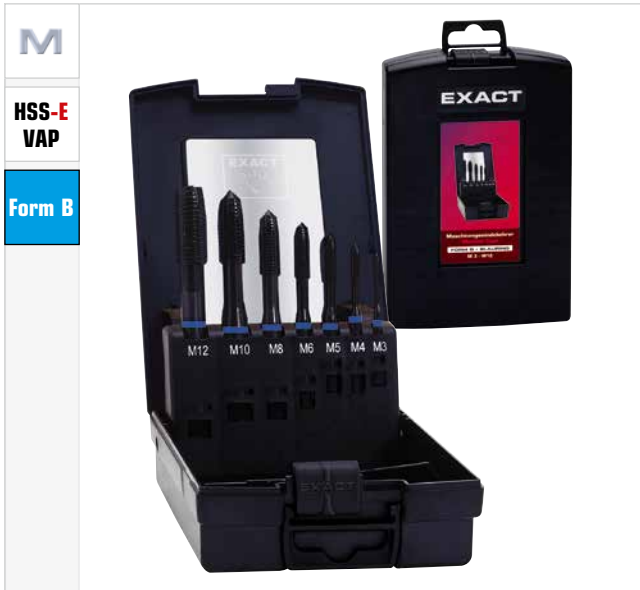

M
HSS-E VAP
Form B

VA + rostfreie Stähle

Maschinengewindebohrer Machine Taps: M3 - M4 - M5 - M6 - M8 - M10 - M12	42305	

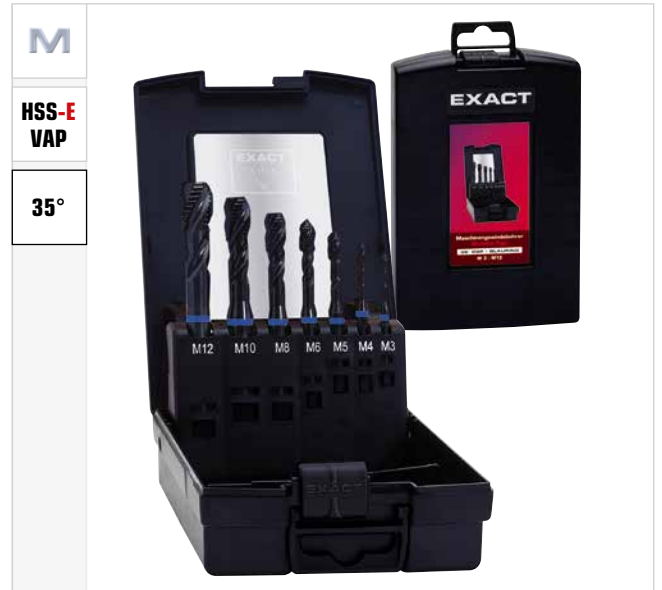

M
HSS-E VAP
35°

Stainless steel

Maschinengewindebohrer Machine Taps: M3 - M4 - M5 - M6 - M8 - M10 - M12	43654	

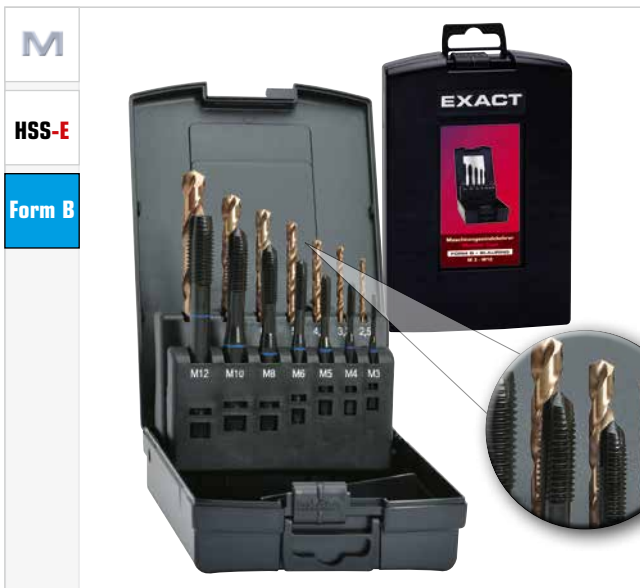

M
HSS-E
Form B

VA + rostfreie Stähle

Maschinengewindebohrer Machine Taps: M3 - M4 - M5 - M6 - M8 - M10 - M12 + Kernlochbohrer Twist Drills: 2,5 - 3,3 - 4,2 - 5 - 6,8 - 8,5 - 10,2	42330	

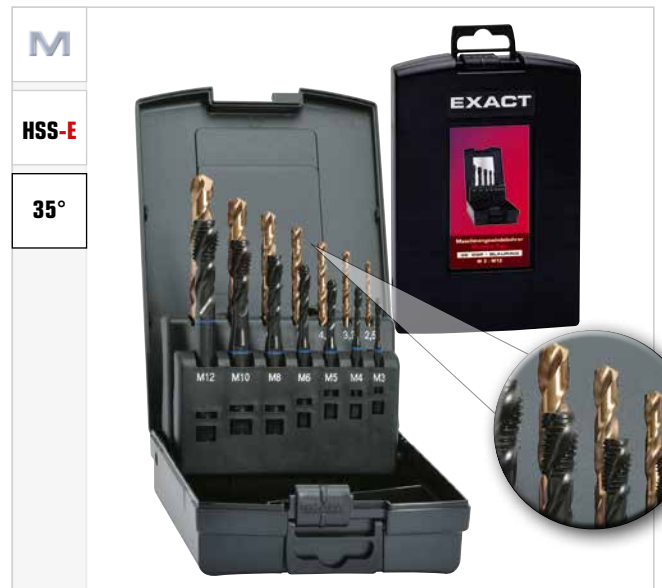

M
HSS-E
35°

Stainless steel

Maschinengewindebohrer Machine Taps: M3 - M4 - M5 - M6 - M8 - M10 - M12 + Kernlochbohrer Twist Drills: 2,5 - 3,3 - 4,2 - 5 - 6,8 - 8,5 - 10,2	43679	

Maschinengewindebohrer DIN 374

Machine Taps DIN 374

Metrisch fein | Metric fine



Technische Information

HSS-E = Hochleistungsschnell-Stahl Klasse E
 Form B = 4-5 Gang Anschnitt mit Schälanschnitt für Durchgangslöcher
 DIN 374 • Für metrisches ISO-Gewinde DIN 13, Toleranz 6H

Technical Information

HSS-E = High-speed-steel E-class
 Form B = 4-5 pitch chamfer, spiral point for through holes
 DIN 374 • For metric ISO-thread DIN 13, tolerance 6H

Anwendung

Zum Schneiden von Innengewinden.

Application

For cutting internal threads.

Mf	mm	mm	mm	mm	mm	mm	CODE	€
Mf 6,0	0,75	5,25	14	80	4,5	3,4	42306	
Mf 8,0	0,75	7,25	19	80	6,0	4,9	42307	
Mf 8,0	1,00	7,00	22	90	6,0	4,9	42308	
Mf 10,0	1,00	9,00	16	90	7,0	5,5	42309	
Mf 10,0	1,25	8,75	24	100	7,0	5,5	42310	
Mf 12,0	1,00	11,00	22	100	9,0	7,0	42311	
Mf 12,0	1,25	10,75	22	100	9,0	7,0	42312	
Mf 12,0	1,50	10,50	22	100	9,0	7,0	42313	
Mf 14,0	1,00	13,00	22	100	11,0	9,0	42314	
Mf 14,0	1,25	12,75	22	100	11,0	9,0	42315	
Mf 14,0	1,50	12,50	22	100	11,0	9,0	42316	
Mf 16,0	1,00	15,00	22	100	12,0	9,0	42317	
Mf 16,0	1,50	14,50	22	100	12,0	9,0	42318	
Mf 18,0	1,00	17,00	22	110	14,0	11,0	42319	
Mf 18,0	1,50	16,50	25	110	14,0	11,0	42320	
Mf 18,0	2,00	16,00	34	125	14,0	11,0	42321	
Mf 20,0	1,00	19,00	25	125	16,0	12,0	42322	
Mf 20,0	1,50	18,50	25	125	16,0	12,0	42323	
Mf 20,0	2,00	18,00	34	140	16,0	12,0	42324	
Mf 22,0	1,00	21,00	25	125	18,0	14,5	42325	
Mf 22,0	1,50	20,50	25	125	18,0	14,5	42326	
Mf 22,0	2,00	20,00	34	140	18,0	14,5	42327	
Mf 24,0	1,00	23,00	28	140	18,0	14,5	42328	
Mf 24,0	1,50	22,50	28	140	18,0	14,5	42329	

Einsatz BLAURING | Application BLUE RING

Baustahl	Baustahl	Auto- matenstahl	Ver- gütungs- stahl	Legierter Stahl	Stahl gehärtet	VA Stahl	VA Stahl	Werk- zeugstahl	Guss	Kupfer	Alu + Legierung	Uni	Schneidöl	Emulsion	Minimal Schmie- rung	Trocken- bearbei- tung	Pressluft
Structural steel	Structural steel	Free- cutting steel	Tempered steel	Alloyed steel	Hardened steel	VA steel	VA steel	Tool steel	Cast iron	Copper	Aluminium + alloy	Uni	Cutting oil	Emulsion	Minimum lubrication	Dry machining	Com- pressed air
≤ 500 N/ mm ²	> 500 N/ mm ²	≤ 1000 N/ mm ²	≤ 1000 N/ mm ²	≤ 1200 N/ mm ²	40 - 60 HRC	≤ 850 N/ mm ²	> 850 N/ mm ²	≤ 1000 N/ mm ²	≤ 300 HB	≤ 400 N/ mm ²	≤ 450 N/ mm ²						
						●	●						●	●	●		

● empfohlen | recommended ○ bedingt geeignet | partly suitable

Maschinengewindebohrer DIN 374

Machine Taps DIN 374

Metrisch fein | Metric fine



Technische Information

HSS-E = Hochleistungsschnell-Stahl Klasse E
35° RSP = 2-3 Gang Anschnitt, 35° Rechtsspirale, für Sacklöcher
DIN 374 • Für metrisches ISO-Gewinde DIN 13, Toleranz 6H

Anwendung

Zum Schneiden von Innengewinden.

Technical Information

HSS-E = High-speed-steel E-class
35° RSP = 2-3 pitch chamfer, with 35° spiral flute, for blind holes
DIN 374 • For metric ISO-thread DIN 13, tolerance 6H

Application

For cutting internal threads.

Mf	mm	mm	mm	mm	mm	mm	CODE	€
Mf 6,0	0,75	5,25	14	80	4,5	3,4	43655	
Mf 8,0	0,75	7,25	19	80	6,0	4,9	43656	
Mf 8,0	1,00	7,00	22	90	6,0	4,9	43657	
Mf 10,0	1,00	9,00	16	90	7,0	5,5	43658	
Mf 10,0	1,25	8,75	24	100	7,0	5,5	43659	
Mf 12,0	1,00	11,00	22	100	9,0	7,0	43660	
Mf 12,0	1,25	10,75	22	100	9,0	7,0	43661	
Mf 12,0	1,50	10,50	22	100	9,0	7,0	43662	
Mf 14,0	1,00	13,00	22	100	11,0	9,0	43663	
Mf 14,0	1,25	12,75	22	100	11,0	9,0	43664	
Mf 14,0	1,50	12,50	22	100	11,0	9,0	43665	
Mf 16,0	1,00	15,00	22	100	12,0	9,0	43666	
Mf 16,0	1,50	14,50	22	100	12,0	9,0	43667	
Mf 18,0	1,00	17,00	22	110	14,0	11,0	43668	
Mf 18,0	1,50	16,50	25	110	14,0	11,0	43669	
Mf 18,0	2,00	16,00	34	125	14,0	11,0	43670	
Mf 20,0	1,00	19,00	25	125	16,0	12,0	43671	
Mf 20,0	1,50	18,50	25	125	16,0	12,0	43672	
Mf 20,0	2,00	18,00	34	140	16,0	12,0	43673	
Mf 22,0	1,00	21,00	25	125	18,0	14,5	43674	
Mf 22,0	1,50	20,50	25	125	18,0	14,5	43675	
Mf 22,0	2,00	20,00	34	140	18,0	14,5	43676	
Mf 24,0	1,00	23,00	28	140	18,0	14,5	43677	
Mf 24,0	1,50	22,50	28	140	18,0	14,5	43678	

Einsatz BLAURING | Application BLUE RING

Baustahl	Baustahl	Auto- matenstahl	Ver- gütungs- stahl	Legierter Stahl	Stahl gehärtet	VA Stahl	VA Stahl	Werk- zeugstahl	Guss	Kupfer	Alu + Legierung	Uni	Schneidöl	Emulsion	Minimal Schmie- rung	Trocken- bearbei- tung	Pressluft
Structural steel	Structural steel	Free- cutting steel	Tempered steel	Alloyed steel	Hardened steel	VA steel	VA steel	Tool steel	Cast iron	Copper	Aluminium + alloy	Uni	Cutting oil	Emulsion	Minimum lubrication	Dry machining	Com- pressed air
≤ 500 N/ mm ²	> 500 N/ mm ²	≤ 1000 N/ mm ²	≤ 1000 N/ mm ²	≤ 1200 N/ mm ²	40 - 60 HRC	≤ 850 N/ mm ²	> 850 N/ mm ²	≤ 1000 N/ mm ²	≤ 300 HB	≤ 400 N/ mm ²	≤ 450 N/ mm ²						
						●	●						●	●	●		

● empfohlen | recommended ○ bedingt geeignet | partly suitable

Maschinengewindebohrer DIN 371/376

Machine Taps DIN 371/376

EXACT
PRÄZISIONSWERKZEUGE

Metrisch | Metric

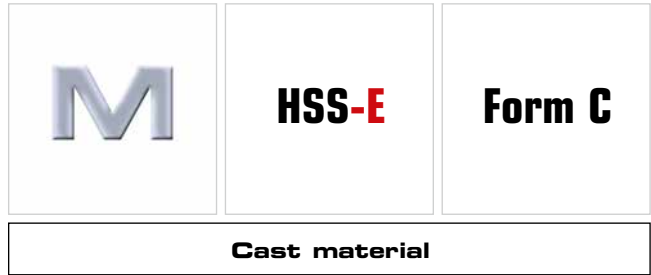

Technische Information

HSS-E = Hochleistungsschnell-Stahl Klasse E
Form C = 2-3 Gang Anschnitt für Durchgangslöcher und Sacklöcher
DIN 371 / 376 • Für metrisches ISO-Gewinde DIN 13, Toleranz 6H

Technical Information

HSS-E = High-speed-steel E-class
Form C = 2-3-pitch chamfer, for through holes and blind holes
DIN 371 / 376 • For metric ISO-thread DIN 13, tolerance 6H

TiCN

Zusätzliche Oberflächenhärtung:

- Oberflächenhärte ca. 3.000 HV
- Schichtstärke bis 4 µm
- **Besonders geeignet für aufschmierende Werkstoffe, Aluminium und VA**
- Erhöhte Standzeiten
- Höhere Schnittgeschwindigkeit

Additional surface hardness:

- Surface treatment ca. 3.000 HV
- Layer Thickness up to 4 µm
- **Good attitudes at greasy materials, Aluminium and VA (Stainless steel)**
- Longer tool-life
- Higher cutting speed

Anwendung

Zum Schneiden von Innengewinden.

Application

For cutting internal threads.

M	mm	mm	mm	mm	mm	mm	CODE	€
mit verstärktem Schaft - DIN 371								
M 3,0	0,50	2,50	11	56	3,5	2,7	43361	
M 4,0	0,70	3,30	13	63	4,5	3,4	43362	
M 5,0	0,80	4,20	16	70	6,0	4,9	43363	
M 6,0	1,00	5,00	19	80	6,0	4,9	43364	
M 8,0	1,25	6,75	22	90	8,0	6,2	43365	
M 10,0	1,50	8,50	24	100	10,0	8,0	43366	
mit durchfallendem Schaft - DIN 376								
M 12,0	1,75	10,25	29	110	9,0	7,0	43367	
M 14,0	2,00	12,00	30	110	11,0	9,0	43368	
M 16,0	2,00	14,00	32	110	12,0	9,0	43369	
M 18,0	2,50	15,50	34	125	14,0	11,0	43370	
M 20,0	2,50	17,50	34	140	16,0	12,0	43371	
M 22,0	2,50	19,50	34	140	18,0	14,5	43372	
M 24,0	3,00	21,00	38	160	18,0	14,5	43373	

Einsatz WEISSRING | Application WHITE RING

Baustahl	Baustahl	Auto- matenstahl Free- cutting steel	Ver- gütungs- stahl Tempered steel	Legierter Stahl Alloyed steel	Stahl gehärtet Hardened steel	VA Stahl VA steel	VA Stahl VA steel	Werk- zeugstahl Tool steel	Guss Cast iron	Kupfer Copper	Alu + Legierung Aluminium + alloy	Uni Uni	Schneidöl Cutting oil	Emulsion Emulsion	Minimal Schmie- rung Minimum lubrication	Trocken- bearbei- tung Dry machining	Pressluft Com- pressed air
≤ 500 N/mm ²	> 500 N/mm ²	≤ 1000 N/mm ²	≤ 1000 N/mm ²	≤ 1200 N/mm ²	40 - 60 HRC	≤ 850 N/mm ²	> 850 N/mm ²	≤ 1000 N/mm ²	≤ 300 HB	≤ 400 N/mm ²	≤ 450 N/mm ²						
									●				●	●	●		

● empfohlen | recommended ○ bedingt geeignet | partly suitable



Für Ihre Notizen
For your notes

EXACT
PRÄZISIONSWERKZEUGE

Maschinengewindebohrer DIN 371 / 376

Machine Taps DIN 371 / 376

EXACT
PRÄZISIONSWERKZEUGE

Metrisch | Metric



Technische Information

HSS-E = Hochleistungsschnell-Stahl Klasse E
 Form B = 5 Gang Anschnitt mit Schälanschnitt für Durchgangslöcher
 35° RSP = 2-Gang Anschnitt für Sacklöcher
 DIN 371 / 376 • Für metrisches ISO-Gewinde DIN 13, Toleranz 6H

Technical Information

HSS-E = High-speed-steel E-class
 Form B = 5-pitch chamfer, spiral point for through holes
 35° RSP = 2-pitch chamfer with 35° spiral flute for blind
 DIN 371 / 376 • For metric ISO-thread DIN 13, tolerance 6H

TIN

Zusätzliche Oberflächenhärtung:

- Oberflächenhärte ca. 2.500 HV
- Schichtstärke bis 2 µm
- Für harte Materialien
- Erhöhte Standzeiten
- Höhere Schnittgeschwindigkeit
- Temperaturbeständig bis 600° C
- Reduziert Kaltaufschweißung

Additional surface hardness:

- Surface treatment ca. 2.500 HV
- Layer Thickness up to 2 µm
- For hard materials
- Higher tool life
- Higher cutting speeds
- Temperature resistant up to 600° C
- Reduces cold weldings

Anwendung

Zum Schneiden von Innengewinden.

Application

For cutting internal threads.

M	mm	mm	mm	mm	mm	mm	mm	CODE	€	CODE	€
mit verstärktem Schaft - DIN 371											
M 3,0	0,50	2,50	11	56	3,5	2,7	02321			03671	
M 4,0	0,70	3,30	13	63	4,5	3,4	02322			03672	
M 5,0	0,80	4,20	16	70	6,0	4,9	02323			03673	
M 6,0	1,00	5,00	19	80	6,0	4,9	02324			03674	
M 8,0	1,25	6,75	22	90	8,0	6,2	02325			03675	
M 10,0	1,50	8,50	24	100	10,0	8,0	02326			03676	
mit durchfallendem Schaft - DIN 376											
M 12,0	1,75	10,25	29	110	9,0	7,0	02327			03677	
M 14,0	2,00	12,00	30	110	11,0	9,0	02345			03660	
M 16,0	2,00	14,00	32	110	12,0	9,0	02346			03661	
M 18,0	2,50	15,50	34	125	14,0	11,0	02347			03662	
M 20,0	2,50	17,50	34	140	16,0	12,0	02348			03663	
M 22,0	2,50	19,50	34	140	18,0	14,5	02349			03664	
M 24,0	3,00	21,00	38	160	18,0	14,5	02350			03665	

Einsatz TIN | Application TIN

Baustahl	Baustahl	Auto-matenstahl	Ver-gütungs-stahl	Legierter Stahl	Stahl gehärtet	VA Stahl	VA Stahl	Werk-zeugstahl	Guss	Kupfer	Alu + Legierung	Uni	Schneidöl	Emulsion	Minimal Schmierung	Trockenbearbeitung	Pressluft
Structural steel	Structural steel	Free-cutting steel	Tempered steel	Alloyed steel	Hardened steel	VA steel	VA steel	Tool steel	Cast iron	Copper	Aluminium + alloy	Uni	Cutting oil	Emulsion	Minimum lubrication	Dry machining	Compressed air
≤ 500 N/mm ²	> 500 N/mm ²	≤ 1000 N/mm ²	≤ 1000 N/mm ²	≤ 1200 N/mm ²	40 - 60 HRC	≤ 850 N/mm ²	> 850 N/mm ²	≤ 1000 N/mm ²	≤ 300 HB	≤ 400 N/mm ²	≤ 450 N/mm ²		●	●	●		

● empfohlen | recommended ○ bedingt geeignet | partly suitable



Maschinengewindebohrer-Sets Machine Tap Sets

EXACT
PRÄZISIONSWERKZEUGE

Metrisch | Metric



M
HSS-E
Form B

TIN mit Titan-Nitrid Beschichtung

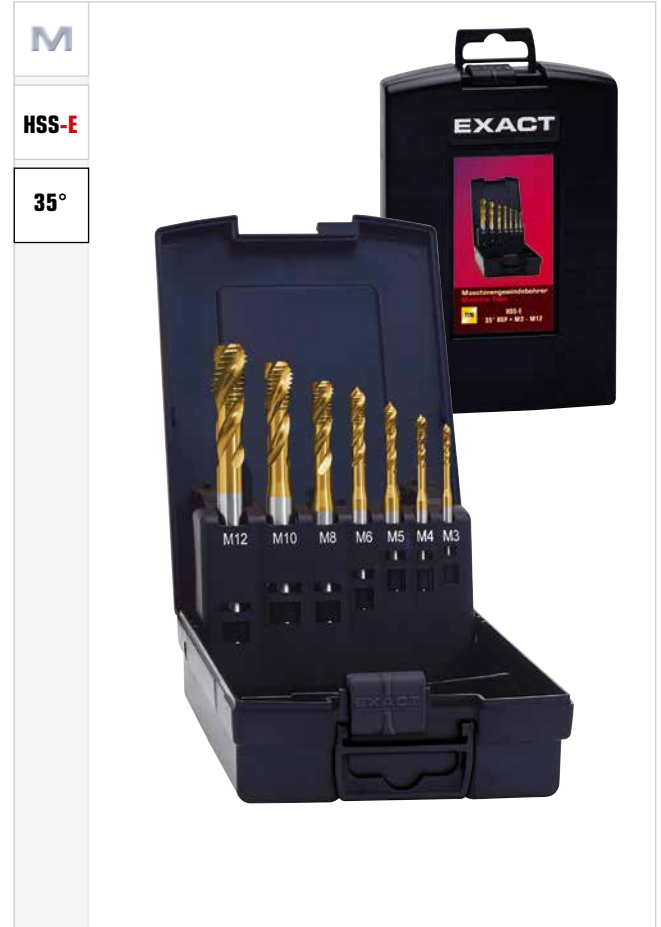

M
HSS-E
35°

TIN with Titan-Nitride Coating

		
Maschinengewindebohrer Machine Taps: M3 - M4 - M5 - M6 - M8 - M10 - M12	02328	

		
Maschinengewindebohrer Machine Taps: M3 - M4 - M5 - M6 - M8 - M10 - M12	03678	

Einsatz TIN Application TIN																	
Baustahl	Baustahl	Auto- matenstahl	Ver- gütungs- stahl	Legierter Stahl	Stahl gehärtet	VA Stahl	VA Stahl	Werk- zeugstahl	Guss	Kupfer	Alu + Legierung	Uni	Schneidöl	Emulsion	Minimal Schmie- rung	Trocken- bearbei- tung	Presluft
Structural steel	Structural steel	Free- cutting steel	Tempered steel	Alloyed steel	Hardened steel	VA steel	VA steel	Tool steel	Cast iron	Copper	Aluminium + alloy	Uni	Cutting oil	Emulsion	Minimum lubrication	Dry machining	Com- pressed air
≤ 500 N/ mm ²	> 500 N/ mm ²	≤ 1000 N/ mm ²	≤ 1000 N/ mm ²	≤ 1200 N/ mm ²	40 - 60 HRC	≤ 850 N/ mm ²	> 850 N/ mm ²	≤ 1000 N/ mm ²	≤ 300 HB	≤ 400 N/ mm ²	≤ 450 N/ mm ²						
			●	●				●					●	●	●		

Maschinengewindebohrer • Machine Taps

Maschinengewindebohrer DIN 371 / 376

Machine Taps DIN 371 / 376

EXACT
PRÄZISIONSWERKZEUGE

Metrisch | Metric



Technische Information

HSS-E = Hochleistungsschnell-Stahl Klasse E
 Form B = 5 Gang Anschnitt mit Schälanschnitt für Durchgangslöcher
 35° RSP = 2-3 Gang Anschnitt, 35° Rechtsspirale, für Sacklöcher
 DIN 371 / 376 • Für metrisches ISO-Gewinde DIN 13, Toleranz 6H

Technical Information

HSS-E = High-speed-steel E-class
 Form B = 5-pitch chamfer, spiral point for through holes
 35° RSP = 2-3 pitch chamfer, with 35° spiral flute, for blind holes
 DIN 371 / 376 • For metric ISO-thread DIN 13, tolerance 6H

TiAIN

Zusätzliche Oberflächenhärtung:

- Oberflächenhärte ca. 3.500 HV
- Schichtstärke bis 4 µm
- Für besonders harte Materialien
- Optimale Standzeiten
- Höchste Schnittgeschwindigkeit
- Temperaturbeständig bis 800° C, kein Kühlmittel notwendig
- Reduziert Kaltaufschweißung

Additional surface hardness:

- Surface treatment ca. 3.500 HV
- Layer Thickness up to 4 µm
- For hardest materials
- Optimized tool life
- Highest cutting speeds
- Temperature resistant up to 800° C
- Reduces cold weldings

Anwendung

Zum Schneiden von Innengewinden.

Application

For cutting internal threads.

M	mm	mm	mm	mm	mm	mm	mm	CODE	€	CODE	€
mit verstärktem Schaft - DIN 371											
M 3,0	0,50	2,50	11	56	3,5	2,7	02481			03585	
M 4,0	0,70	3,30	13	63	4,5	3,4	02482			03586	
M 5,0	0,80	4,20	16	70	6,0	4,9	02483			03587	
M 6,0	1,00	5,00	19	80	6,0	4,9	02484			03588	
M 8,0	1,25	6,75	22	90	8,0	6,2	02485			03589	
M 10,0	1,50	8,50	24	100	10,0	8,0	02486			03590	
mit durchfallendem Schaft - DIN 376											
M 12,0	1,75	10,25	29	110	9,0	7,0	02487			03591	
M 14,0	2,00	12,00	30	110	11,0	9,0	02488			03592	
M 16,0	2,00	14,00	32	110	12,0	9,0	02489			03593	
M 18,0	2,50	15,50	34	125	14,0	11,0	02490			03594	
M 20,0	2,50	17,50	34	140	16,0	12,0	02491			03595	
M 22,0	2,50	19,50	34	140	18,0	14,5	02492			03596	
M 24,0	3,00	21,00	38	160	18,0	14,5	02493			03597	

Einsatz TiAIN | Application TiAIN

Baustahl	Baustahl	Auto- matenstahl Free- cutting steel	Ver- gütungs- stahl Tempered steel	Legierter Stahl Alloyed steel	Stahl gehärtet Hardened steel	VA Stahl VA steel	VA Stahl VA steel	Werk- zeugstahl Tool steel	Guss Cast iron	Kupfer Copper	Alu + Legierung Aluminium + alloy	Uni Uni	Schneidöl Cutting oil	Emulsion Emulsion	Minimal Schmie- rung Minimum lubrication	Trocken- bearbei- tung Dry machining	Pressluft Com- pressed air
≤ 500 N/mm ²	> 500 N/mm ²	≤ 1000 N/mm ²	≤ 1000 N/mm ²	≤ 1200 N/mm ²	40 - 60 HRC	≤ 850 N/mm ²	> 850 N/mm ²	≤ 1000 N/mm ²	≤ 300 HB	≤ 400 N/mm ²	≤ 450 N/mm ²						
		●	●			○	○	●							●	●	

● empfohlen | recommended ○ bedingt geeignet | partly suitable

Maschinengewindebohrer • Machine Taps



Maschinengewindebohrer-Sets Machine Tap Sets

EXACT
PRÄZISIONSWERKZEUGE

Metrisch | Metric



M
HSS-E
Form B

TiAlN mit Titan-Aluminium-Nitrid Beschichtung

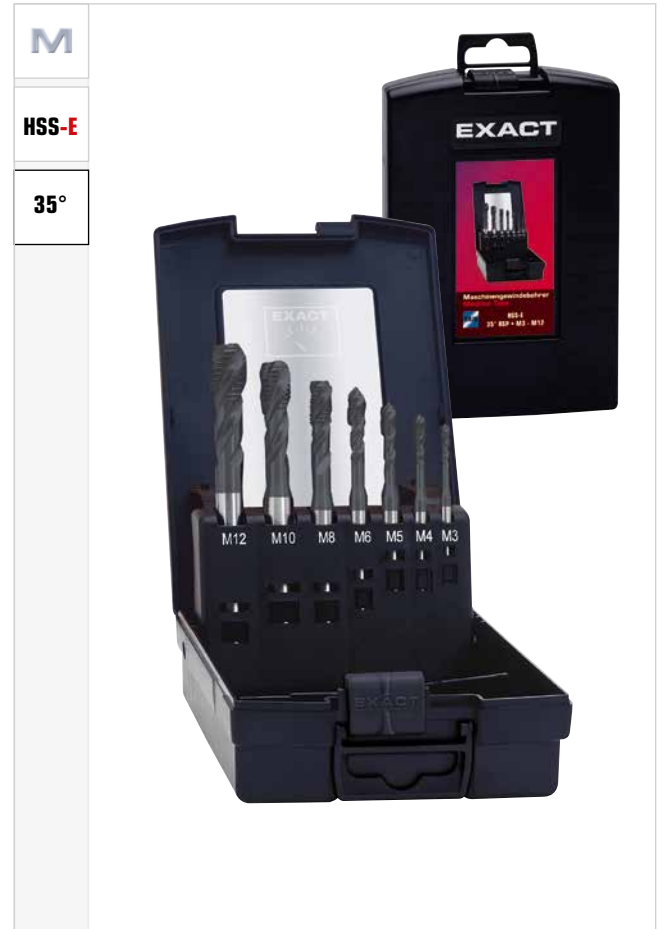

M
HSS-E
35°

TiAlN with Titan-Aluminium-Nitride Coating

INHALT	CODE	€ SET
Maschinengewindebohrer Machine Taps: M3 - M4 - M5 - M6 - M8 - M10 - M12	02494	

INHALT	CODE	€ SET
Maschinengewindebohrer Machine Taps: M3 - M4 - M5 - M6 - M8 - M10 - M12	03598	

Einsatz TiAlN Application TiAlN																	
Baustahl	Baustahl	Auto- matenstahl	Ver- gütungs- stahl	Legierter Stahl	Stahl gehärtet	VA Stahl	VA Stahl	Werk- zeugstahl	Guss	Kupfer	Alu + Legierung	Uni	Schneidöl	Emulsion	Minimal Schmie- rung	Trocken- bearbei- tung	Presluft
Structural steel	Structural steel	Free- cutting steel	Tempered steel	Alloyed steel	Hardened steel	VA steel	VA steel	Tool steel	Cast iron	Copper	Aluminium + alloy	Uni	Cutting oil	Emulsion	Minimum lubrication	Dry machining	Com- pressed air
≤ 500 N/ mm ²	> 500 N/ mm ²	≤ 1000 N/ mm ²	≤ 1000 N/ mm ²	≤ 1200 N/ mm ²	40 - 60 HRC	≤ 850 N/ mm ²	> 850 N/ mm ²	≤ 1000 N/ mm ²	≤ 300 HB	≤ 400 N/ mm ²	≤ 450 N/ mm ²						
			●	●		○	○	●							●	●	

● empfohlen | recommended ○ bedingt geeignet | partly suitable

Maschinengewindebohrer • Machine Taps

Maschinengewindebohrer DIN 371 / 376

Machine Taps DIN 371 / 376

EXACT
PRÄZISIONSWERKZEUGE

Metrisch | Metric



Technische Information

HSS-E = Hochleistungsschnell-Stahl Klasse E
 Form B-AZ = 4-5 Gang Anschnitt mit Schälanschnitt und ausgesetzten
 Zähnen für Durchgangslöcher
 Für metrisches ISO-Gewinde DIN 13, Toleranz 6H

Technical Information

HSS-E = High-speed-steel E-class
 Form B-AZ = 4-5 pitch chamfer, spiral point, with interrupted thread
 for through holes
 For metric ISO-thread DIN 13, tolerance 6H

Anwendung

Zum Schneiden von Innengewinden. Für kurzspanende Werkstoffe.

Application

For cutting internal threads. For short-chipping materials.

M	mm	mm	mm	mm	mm	mm	mm	CODE	€
mit verstärktem Schaft - DIN 371									
M 3,0	0,50	2,50	11	56	3,5	2,7	03331		
M 4,0	0,70	3,30	13	63	4,5	3,4	03332		
M 5,0	0,80	4,20	16	70	6,0	4,9	03333		
M 6,0	1,00	5,00	19	80	6,0	4,9	03334		
M 8,0	1,25	6,75	22	90	8,0	6,2	03335		
M 10,0	1,50	8,50	24	100	10,0	8,0	03336		
mit durchfallendem Schaft - DIN 376									
M 12,0	1,75	10,25	29	110	9,0	7,0	03337		
M 14,0	2,00	12,00	30	110	11,0	9,0	03338		
M 16,0	2,00	14,00	32	110	12,0	9,0	03339		
M 18,0	2,50	15,50	34	125	14,0	11,0	03340		
M 20,0	2,50	17,50	34	140	16,0	12,0	03341		
M 22,0	2,50	19,50	34	140	18,0	14,5	03342		
M 24,0	3,00	21,00	38	160	18,0	14,5	03343		

Einsatz FORM B-AZ | Application FORM B-AZ

Baustahl	Baustahl	Auto- matenstahl	Vergü- tungs- stahl	Legierter Stahl	Stahl gehärtet	VA Stahl	VA Stahl	Werk- zeugstahl	Guss	Kupfer	Alu + Legierung	Uni	Schneidöl	Emulsion	Minimal Schmie- rung	Trocken- bearbei- tung	Pressluft
Structural steel	Structural steel	Free- cutting steel	Tempered steel	Alloyed steel	Hardened steel	VA steel	VA steel	Tool steel	Cast iron	Copper	Aluminium + alloy	Uni	Cutting oil	Emulsion	Minimum lubrication	Dry machining	Com- pressed air
≤ 500 N/ mm ²	> 500 N/ mm ²	≤ 1000 N/ mm ²	≤ 1000 N/ mm ²	≤ 1200 N/ mm ²	40 - 60 HRC	≤ 850 N/ mm ²	> 850 N/ mm ²	≤ 1000 N/ mm ²	≤ 300 HB	≤ 400 N/ mm ²	≤ 450 N/ mm ²						
●	●									●	●		●	●			

● empfohlen | recommended ○ bedingt geeignet | partly suitable

Kombigewindebohrer Combined Taps

Metrisch | Metric



Technische Information

HSS-E = Hochleistungsschnell-Stahl Klasse E
Für metrisches ISO-Gewinde DIN 13, Toleranz 6H

Anwendung

Kernlochbohren und Gewindeschneiden in 1 Arbeitsgang.

Technical Information

HSS-E = High-speed-steel E-class
For metric ISO-thread DIN 13, tolerance 6H

Application

Drill core holes and tap the thread all in 1 working step.

M	mm	mm	mm	mm	mm	mm	CODE	€
M 3	0,50	56	11	3,0	2,4		03441	
M 4	0,70	63	14	4,0	3,0		03442	
M 5	0,80	71	18	5,0	3,8		03443	
M 6	1,00	80	22	6,0	4,9		03444	
M 8	1,25	95	25	8,0	6,2		03445	
M 10	1,50	106	31	10,0	8,0		03446	
M 12	1,75	115	35	12,0	9,0		03447	

Weitere Abmessungen auf Anfrage lieferbar | Other sizes available on request

Kombigewindebohrer-Set in Stahlblechkassette | Set of Combined Taps

M	Ohne Abbildung Without foto
HSS-E	

INHALT	CODE	€
Kombigewindebohrer Combined Taps: M3 - M4 - M5 - M6 - M8 - M10 - M12	03448	SET

Technische Information

HSS-E = Hochleistungsschnell-Stahl Klasse E
Für metrisches ISO-Gewinde DIN 13, Toleranz 6H

Anwendung

Kernlochbohren und Gewindeschneiden in 1 Arbeitsgang.

Technical Information

HSS-E = High-speed-steel E-class
For metric ISO-thread DIN 13, tolerance 6H

Application

Drill core holes and tap the thread all in 1 working step.

Einsatz Kombigewindebohrer | Application Combined Taps

Baustahl	Baustahl	Auto- matenstahl	Ver- gütungs- stahl	Legierter Stahl	Stahl gehärtet	VA Stahl	VA Stahl	Werk- zeugstahl	Guss	Kupfer	Alu + Legierung	Uni	Schneidöl	Emulsion	Minimal Schmie- rung	Trocken- bearbei- tung	Pressluft
Structural steel	Structural steel	Free- cutting steel	Tempered steel	Alloyed steel	Hardened steel	VA steel	VA steel	Tool steel	Cast iron	Copper	Aluminium + alloy	Uni	Cutting oil	Emulsion	Minimum lubrication	Dry machining	Com- pressed air
≤ 500 N/ mm ²	> 500 N/ mm ²	≤ 1000 N/ mm ²	≤ 1000 N/ mm ²	≤ 1200 N/ mm ²	40 - 60 HRC	≤ 850 N/ mm ²	> 850 N/ mm ²	≤ 1000 N/ mm ²	≤ 300 HB	≤ 400 N/ mm ²	≤ 450 N/ mm ²						
●	○					○			○		●		●				

● empfohlen | recommended ○ bedingt geeignet | partly suitable

Maschinengewindebohrer lange Ausführung

Machine Taps long version

EXACT
PRÄZISIONSWERKZEUGE

Metrisch | Metric

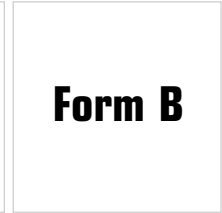
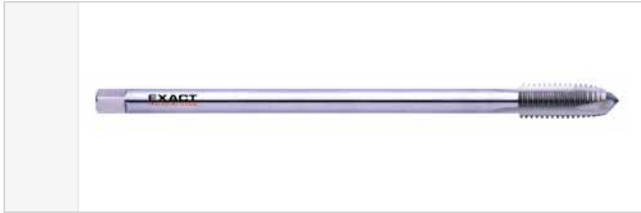

Technische Information

HSS-E = Hochleistungsschnell-Stahl Klasse E
 Form B = 5 Gang Anschnitt mit Schälanschnitt für Durchgangslöcher
 DIN 371 / 376 • Für metrisches ISO-Gewinde DIN 13, Toleranz 6H

Technical Information

HSS-E = High-speed-steel E-class
 Form B = 5-pitch chamfer, spiral point for through holes
 DIN 371 / 376 • For metric ISO-thread DIN 13, tolerance 6H

Anwendung

Zum Schneiden von Innengewinden.

Application

For cutting internal threads.

M	mm	mm	mm	mm	mm	mm	CODE	€
mit verstärktem Schaft - DIN 371								
M 3,0	0,50	2,50	10	100	3,5	2,7	43731	
M 4,0	0,70	3,30	12	120	4,5	3,4	43732	
M 5,0	0,80	4,20	14	140	6,0	4,9	43733	
M 6,0	1,00	5,00	16	160	6,0	4,9	43734	
M 8,0	1,25	6,75	18	180	8,0	6,2	43735	
mit durchfallendem Schaft - DIN 376								
M 10,0	1,50	8,50	20	200	7,0	5,5	43736	
M 12,0	1,75	10,25	22	220	9,0	7,0	43737	
M 14,0	2,00	12,00	25	220	11,0	9,0	43738	
M 16,0	2,00	14,00	28	220	12,0	9,0	43739	
M 18,0	2,50	15,50	32	250	14,0	11,0	43740	
M 20,0	2,50	17,50	32	250	16,0	12,0	43741	
M 22,0	2,50	19,50	32	250	18,0	14,5	43742	
M 24,0	3,00	21,00	36	250	18,0	14,5	43743	

Einsatz LANGE AUSFÜHRUNG Application LONG VERSION																	
Baustahl	Baustahl	Auto- matenstahl	Ver- gütungs- stahl	Legierter Stahl	Stahl gehärtet	VA Stahl	VA Stahl	Werk- zeugstahl	Guss	Kupfer	Alu + Legierung	Uni	Schneidöl	Emulsion	Minimal Schmie- rung	Trocken- bearbei- tung	Pressluft
Structural steel	Structural steel	Free- cutting steel	Tempered steel	Alloyed steel	Hardened steel	VA steel	VA steel	Tool steel	Cast iron	Copper	Aluminium + alloy	Uni	Cutting oil	Emulsion	Minimum lubrication	Dry machining	Com- pressed air
≤ 500 N/ mm ²	> 500 N/ mm ²	≤ 1000 N/ mm ²	≤ 1000 N/ mm ²	≤ 1200 N/ mm ²	40 - 60 HRC	≤ 850 N/ mm ²	> 850 N/ mm ²	≤ 1000 N/ mm ²	≤ 300 HB	≤ 400 N/ mm ²	≤ 450 N/ mm ²						
●	●	●	○					○		○			●	●	●		

● empfohlen | recommended ○ bedingt geeignet | partly suitable



Maschinengewindebohrer lange Ausführung

Machine Taps long version

Metrisch | Metric

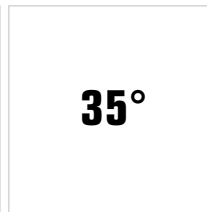

Technische Information

HSS-E = Hochleistungsschnell-Stahl Klasse E
 35° RSP = 2 Gang Anschnitt für Sacklöcher
 DIN 371 / 376 • Für metrisches ISO-Gewinde DIN 13, Toleranz 6H

Anwendung

Zum Schneiden von Innengewinden.

Technical Information

HSS-E = High-speed-steel E-class
 35° RSP = 2-pitch chamfer with 35° spiral flute for blind holes
 DIN 371 / 376 • For metric ISO-thread DIN 13, tolerance 6H

Application

For cutting internal threads.

M	mm	mm	mm	mm	mm	mm	mm	CODE	€
mit verstärktem Schaft - DIN 371									
M 3,0	0,50	2,50	6	100	3,5	2,7	43751		
M 4,0	0,70	3,30	7	120	4,5	3,4	43752		
M 5,0	0,80	4,20	8	140	6,0	4,9	43753		
M 6,0	1,00	5,00	9	160	6,0	4,9	43754		
M 8,0	1,25	6,75	11	180	8,0	6,2	43755		
mit durchfallendem Schaft - DIN 376									
M 10,0	1,50	8,50	12	200	7,0	5,5	43756		
M 12,0	1,75	10,25	14	220	9,0	7,0	43757		
M 14,0	2,00	12,00	18	220	11,0	9,0	43758		
M 16,0	2,00	14,00	18	220	12,0	9,0	43759		
M 18,0	2,50	15,50	22	250	14,0	11,0	43760		
M 20,0	2,50	17,50	22	250	16,0	12,0	43761		
M 22,0	2,50	19,50	22	250	18,0	14,5	43762		
M 24,0	3,00	21,00	28	250	18,0	14,5	43763		

Einsatz LANGE AUSFÜHRUNG Application LONG VERSION																		
Baustahl	Baustahl	Auto- matenstahl	Ver- gütungs- stahl	Legierter Stahl	Stahl gehärtet	VA Stahl	VA Stahl	Werk- zeugstahl	Guss	Kupfer	Alu + Legierung	Uni	Schneidöl	Emulsion	Minimal Schmie- rung	Trocken- bearbei- tung	Pressluft	
Structural steel	Structural steel	Free- cutting steel	Tempered steel	Alloyed steel	Hardened steel	VA steel	VA steel	Tool steel	Cast iron	Copper	Aluminium + alloy	Uni	Cutting oil	Emulsion	Minimum lubrication	Dry machining	Com- pressed air	
≤ 500 N/ mm ²	> 500 N/ mm ²	≤ 1000 N/ mm ²	≤ 1000 N/ mm ²	≤ 1200 N/ mm ²	40 - 60 HRC	≤ 850 N/ mm ²	> 850 N/ mm ²	≤ 1000 N/ mm ²	≤ 300 HB	≤ 400 N/ mm ²	≤ 450 N/ mm ²							
●	●	●	○					○		○			●	●	●			

● empfohlen | recommended ○ bedingt geeignet | partly suitable



Maschinennutergewindebohrer Machine Nut Taps

EXACT
PRÄZISIONSWERKZEUGE

Maschinengewindebohrer • Machine Taps

Metrisch | Metric



Technische Information

HSS-E = Hochleistungsschnell-Stahl Klasse E

DIN 357 • Für metrisches ISO-Gewinde DIN 13, Toleranz 6H

Anwendung

Zum Schneiden von Innengewinden.

Technical Information

HSS-E = High-speed-steel E-class

DIN 357 • For metric ISO-thread DIN 13, tolerance 6H

Application

For cutting internal threads.

M							CODE	€
M 3,0	0,50	2,50	22	70	2,2	-	03381	
M 4,0	0,70	3,30	25	90	2,8	2,1	03382	
M 5,0	0,80	4,20	28	100	3,5	2,7	03383	
M 6,0	1,00	5,00	32	110	4,5	3,4	03384	
M 8,0	1,25	6,75	40	125	6,0	4,9	03385	
M 10,0	1,50	8,50	45	140	7,0	5,5	03386	
M 12,0	1,75	10,25	50	180	9,0	7,0	03387	
M 14,0	2,00	12,00	56	200	11,0	9,0	03388	
M 16,0	2,00	14,00	63	200	12,0	9,0	03389	
M 18,0	2,50	15,50	63	220	14,0	11,0	03390	
M 20,0	2,50	17,50	70	250	16,0	12,0	03391	
M 22,0	2,50	19,50	80	280	18,0	14,5	03392	
M 24,0	3,00	21,00	80	280	18,0	14,5	03393	

Einsatz MUTTERGEWINDEBOHRER Application NUT TAPS																		
	Baustahl	Baustahl	Auto- matenstahl Free- cutting steel	Ver- gütungs- stahl Tempered steel	Legierter Stahl Alloyed steel	Stahl gehärtet Hardened steel	VA Stahl	VA Stahl	Werk- zeugstahl Tool steel	Guss Cast iron	Kupfer Copper	Alu + Legierung Aluminium + alloy	Uni Uni	Schneidöl Cutting oil	Emulsion Emulsion	Minimal Schmie- rung Minimum lubrication	Trocken- bearbei- tung Dry machining	Pressluft Com- pressed air
	≤ 500 N/ mm ²	> 500 N/ mm ²	≤ 1000 N/ mm ²	≤ 1000 N/ mm ²	≤ 1200 N/ mm ²	40 - 60 HRC	≤ 850 N/ mm ²	> 850 N/ mm ²	≤ 1000 N/ mm ²	≤ 300 HB	≤ 400 N/ mm ²	≤ 450 N/ mm ²						
	●	●	●	●	○		●		○	●	●	●		●	●	●		

● empfohlen | recommended ○ bedingt geeignet | partly suitable



Maschinennutergewindebohrer Machine Nut Taps

Trapez-Gewinde | Trapezoidal thread



Technische Information

HSS-E = Hochleistungsschnell-Stahl Klasse E
DIN 103 • Für metrisches ISO-Trapez-Gewinde, Toleranz 7H

Anwendung

Zum Schneiden von Innengewinden.

Technical Information

HSS-E = High-speed-steel E-class
DIN 103 • For metric ISO trapezoidal thread, tolerance 7H

Application

For cutting internal threads.

Tr	mm	mm	mm	mm	mm	mm	mm	CODE	€
10	2	8,20	70	115	7,0	5,5	03402		
12	3	9,25	90	147	9,0	7,0	03403		
14	3	11,25	95	150	10,0	8,0	03404		
16	4	12,25	120	196	12,0	9,0	03405		
18	4	14,25	124	200	14,0	11,0	03406		
20	4	16,25	128	204	16,0	12,0	03407		
22	5	17,25	145	240	17,0	13,0	03408		
24	5	19,25	150	245	19,0	14,5	03409		
26	5	21,25	155	250	21,0	16,0	03410		
28	5	23,25	160	255	23,0	18,0	03411		
30	6	24,25	174	288	24,0	18,0	03412		
32	6	26,25	180	294	26,0	20,0	03413		

Einsatz MUTTERGEWINDEBOHRER Application NUT TAPS																	
Baustahl	Baustahl	Auto- matenstahl	Ver- gütungs- stahl	Legierter Stahl	Stahl gehärtet	VA Stahl	VA Stahl	Werk- zeugstahl	Guss	Kupfer	Alu + Legierung	Uni	Schneidöl	Emulsion	Minimal Schmie- rung	Trocken- bearbei- tung	Pressluft
Structural steel	Structural steel	Free- cutting steel	Tempered steel	Alloyed steel	Hardened steel	VA steel	VA steel	Tool steel	Cast iron	Copper	Aluminium + alloy	Uni	Cutting oil	Emulsion	Minimum lubrication	Dry machining	Com- pressed air
≤ 500 N/ mm ²	> 500 N/ mm ²	≤ 1000 N/ mm ²	≤ 1000 N/ mm ²	≤ 1200 N/ mm ²	40 - 60 HRC	≤ 850 N/ mm ²	> 850 N/ mm ²	≤ 1000 N/ mm ²	≤ 300 HB	≤ 400 N/ mm ²	≤ 450 N/ mm ²						
●	●	●	●	○		●		○	●	●	●		●	●	●		

● empfohlen | recommended ○ bedingt geeignet | partly suitable

Gewindeformer DIN 371 / 376

Forming Taps DIN 371 / 376

EXACT
PRÄZISIONSWERKZEUGE

Spanloses Gewinden | Non-Cutting threading

Vorteile

- Kein Verkleben des Materials an der Spankammer da keine Nuten
- Keine Späne durch spanloses Formen
- Stabile Genauigkeiten auch bei hoher Produktionsmenge
- Höhere Drehzahlen – dadurch kleinere Taktzeiten möglich
- Keine Unterbrechung des Faserverlaufs im Material zur Zerspänung

Advantages

- No squeeze of the material at the chip because there are no flutes
- No chips because of chip-less forming
- Stable exactness at high output
- Higher speed – smaller cycle time possible

Materialbearbeitung

Buntmetalle (Bronze, Kupfer, Messing), Alulegierungen (bis 12 % Si-Anteil), rostfreie Stähle, Stähle bis 900 N/mm²

Material treatment

Non-ferrous metal (bronze, copper, brass), Aluminium-alloy (up to 12 % Si-part), Stainless steel up to 900 N/mm²

Spanlose Fertigung | Non-Cutting producing

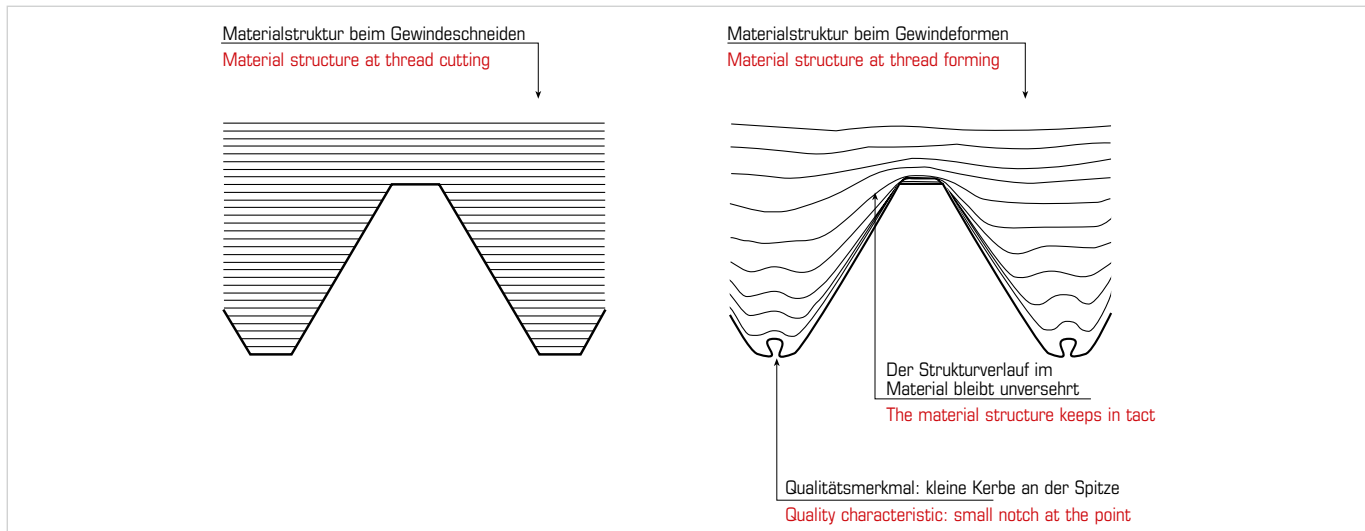

Metrisch | Metric



Technische Information

HSS-E = Hochleistungsschnell-Stahl Klasse E
 Form B = 4 - 6 Gang Abschnitt für Durchgangs- und Sacklöcher
 TIN = Mit Titan-Nitrid Beschichtung
DIN 371 / 376 • Für metrisches ISO-Gewinde DIN 13, Toleranz 6H

Technical Information

HSS-E = High-speed-steel E-class
 Form B = 4 - 6-pitch chamfer, spiral point for through and blind holes
 TIN = With titanium-nitride coating
DIN 371 / 376 • For metric ISO-thread DIN 13, tolerance 6H

M	mm	mm	mm	mm	CODE	€	CODE	€
mit verstärktem Schaft - DIN 371								
M 3,0	0,50	2,80	10	56	03631		03611	
M 4,0	0,70	3,70	12	63	03632		03612	
M 5,0	0,80	4,65	14	70	03633		03613	
M 6,0	1,00	5,55	19	80	03634		03614	
M 8,0	1,25	7,45	22	90	03635		03615	
M 10,0	1,50	9,35	24	100	03636		03616	
mit durchfallendem Schaft - DIN 376								
M 12,0	1,75	11,20	29	110	03637		03617	

Weitere Abmessungen und Ausführungen mit Schmiernut auf Anfrage
Other sizes and versions with grooves on request



Für Ihre Notizen
For your notes

EXACT
PRÄZISIONSWERKZEUGE



DIN371 B M8 ISO2107
HSSG-E
BDD

M8 HSSG-E
HSSG-E M8

M8 H9
HSSG-E M8

DIN371 B M8 ISO2107
HSSG-E M8

MASCHINENGEWINDE MACHINE TAPS

EVENTUS®
by EXACT

Universeller Einsatz

Universal using

■ metrisch

148-151

mit TIN-Beschichtung

with TIN-Coating

■ metrisch

152-153

mit TiAlN-Beschichtung

with TiAlN-Coating

■ metrisch

154-155

Maschinengewindebohrer DIN 371/376

Machine Taps DIN 371/376

EVENTUS
by EXACT

Metrisch | Metric



Technische Information

HSS = Hochleistungsschnell-Stahl
 Form B = 5 Gang Anschnitt mit Schälanschnitt, für Durchgangslöcher
 35° RSP = 2 Gang Anschnitt für Sacklöcher
 DIN 371 / 376 • Für metrisches ISO-Gewinde DIN 13, Toleranz 6H

Anwendung

Zum Schneiden von Innengewinden.

Technical Information

HSS = High-speed-steel
 Form B = 5-pitch chamfer, spiral point for through holes
 35° RSP = 2-pitch chamfer with 35° spiral flute for blind holes
 DIN 371 / 376 • For metric ISO-thread DIN 13, tolerance 6H

Application

For cutting internal threads.

M	mm	mm	mm	mm	CODE FORM B	€	CODE 35° RSP	€
mit verstärktem Schaft - DIN 371								
M 2,0	0,40	1,60	8	45	10299		10349	
M 2,5	0,45	2,05	9	50	10300		10350	
M 3,0	0,50	2,50	11	56	10301		10351	
M 4,0	0,70	3,30	13	63	10302		10352	
M 5,0	0,80	4,20	16	70	10303		10353	
M 6,0	1,00	5,00	19	80	10304		10354	
M 8,0	1,25	6,75	22	90	10305		10355	
M 10,0	1,50	8,50	24	100	10306		10356	
mit durchfallendem Schaft - DIN 376								
M 12,0	1,75	10,25	29	110	10307		10357	
M 14,0	2,00	12,00	30	110	10308		10358	
M 16,0	2,00	14,00	32	110	10309		10359	
M 18,0	2,50	15,50	34	125	10310		10360	
M 20,0	2,50	17,50	34	140	10311		10361	
M 22,0	2,50	19,50	34	140	10312		10362	
M 24,0	3,00	21,00	38	160	10313		10363	



Maschinengewindebohrer Sets Machine Tap Sets

EVENTUS[®]
by EXACT

Metrisch | Metric

Maschinengewindebohrer • Machine Taps

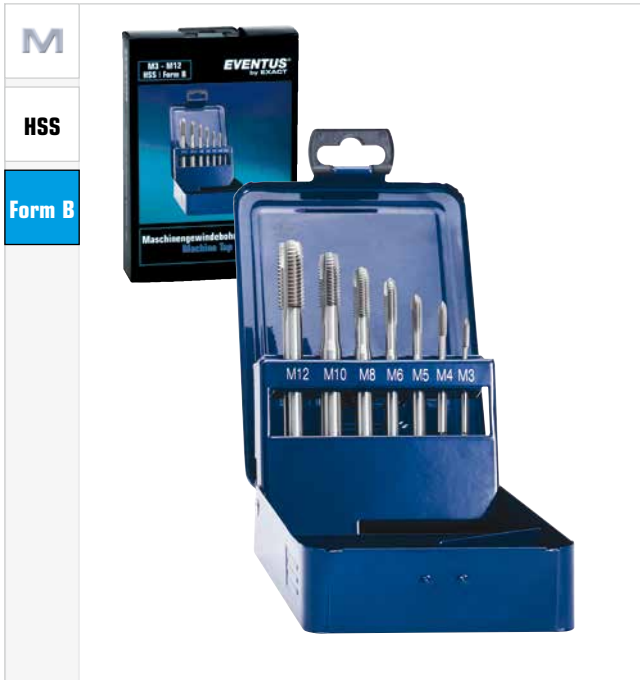

Maschinengewindebohrer Machine Taps: HSS: M3 - M4 - M5 - M6 - M8 - M10 - M12		
	10316	

Maschinengewindebohrer Machine Taps: HSS: M3 - M4 - M5 - M6 - M8 - M10 - M12		
	10366	

Metrisch | Metric

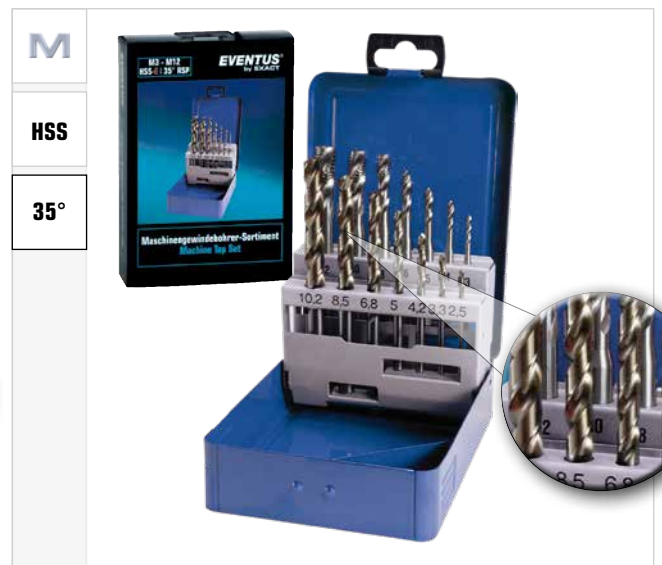
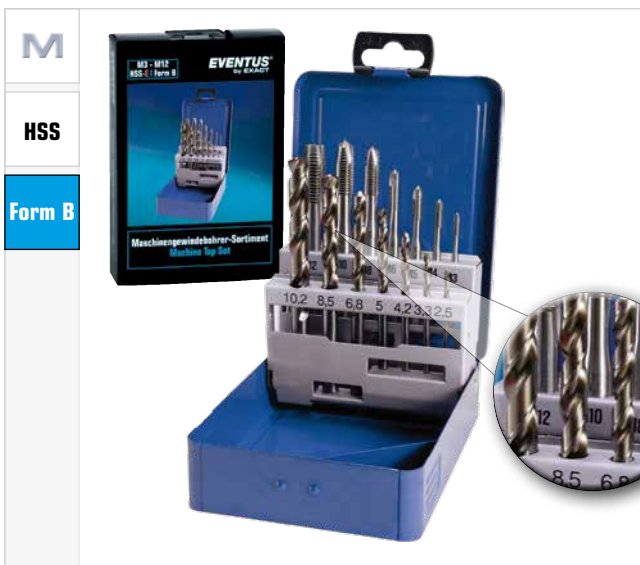

Maschinengewindebohrer Machine Taps + Spiralbohrer + Twist Drills		
HSS: M3 - M4 - M5 - M6 - M8 - M10 - M12		
	10317	

Maschinengewindebohrer Machine Taps + Spiralbohrer + Twist Drills		
HSS: M3 - M4 - M5 - M6 - M8 - M10 - M12		
	10367	

Maschinengewindebohrer DIN 371/376

Machine Taps DIN 371/376

EVENTUS
by EXACT

Metrisch | Metric

HSS-E



Form B

Technische Information

HSS-E = Hochleistungsschnell-Stahl Klasse E
 Form B = 5 Gang Anschnitt mit Schälanschnitt, für Durchgangslöcher
 35° RSP = 2 Gang Anschnitt für Sacklöcher
 DIN 371 / 376 • Für metrisches ISO-Gewinde DIN 13, Toleranz 6H

Anwendung

Zum Schneiden von Innengewinden.

HSS-E



35°

Technical Information

HSS-E = High-speed-steel E-class
 Form B = 5-pitch chamfer, spiral point for through holes
 35° RSP = 2-pitch chamfer with 35° spiral flute for blind holes
 DIN 371 / 376 • For metric ISO-thread DIN 13, tolerance 6H

Application

For cutting internal threads.

M	mm	mm	mm	mm	CODE FORM B	€	CODE 35° RSP	€
mit verstärktem Schaft - DIN 371								
M 2,0	0,40	1,60	8	45	10319		10379	
M 2,5	0,45	2,05	9	50	10320		10380	
M 3,0	0,50	2,50	11	56	10321		10381	
M 4,0	0,70	3,30	13	63	10322		10382	
M 5,0	0,80	4,20	16	70	10323		10383	
M 6,0	1,00	5,00	19	80	10324		10384	
M 8,0	1,25	6,75	22	90	10325		10385	
M 10,0	1,50	8,50	24	100	10326		10386	
mit durchfallendem Schaft - DIN 376								
M 12,0	1,75	10,25	29	110	10327		10387	
M 14,0	2,00	12,00	30	110	10328		10388	
M 16,0	2,00	14,00	32	110	10329		10389	
M 18,0	2,50	15,50	34	125	10330		10390	
M 20,0	2,50	17,50	34	140	10331		10391	
M 22,0	2,50	19,50	34	140	10332		10392	
M 24,0	3,00	21,00	38	160	10333		10393	



Maschinengewindebohrer Sets Machine Tap Sets

EVENTUS[®]
by EXACT

Metrisch | Metric

Maschinengewindebohrer • Machine Taps

M	
HSS-E	
Form B	

M	
HSS-E	
35°	

Maschinengewindebohrer Machine Taps: HSS-E: M3 - M4 - M5 - M6 - M8 - M10 - M12		
	10336	

Maschinengewindebohrer Machine Taps: HSS-E: M3 - M4 - M5 - M6 - M8 - M10 - M12		
	10396	

Metrisch | Metric

M	
HSS-E	
Form B	

M	
HSS-E	
35°	

Maschinengewindebohrer Machine Taps + Spiralbohrer + Twist Drills		
HSS-E: M3 - M4 - M5 - M6 - M8 - M10 - M12		
	10337	

Maschinengewindebohrer Machine Taps + Spiralbohrer + Twist Drills		
HSS-E: M3 - M4 - M5 - M6 - M8 - M10 - M12		
	10397	

Maschinengewindebohrer DIN 371/376

Machine Taps DIN 371/376

EVENTUS
by EXACT

Metrisch | Metric

HSS
TIN



Form B

Technische Information

HSS = Hochleistungsschnell-Stahl
Form B = 5 Gang Anschnitt mit Schälanschnitt, für Durchgangslöcher
35° RSP = 2 Gang Anschnitt für Sacklöcher
DIN 371 / 376 • Für metrisches ISO-Gewinde DIN 13, Toleranz 6H

Anwendung

Zum Schneiden von Innengewinden.

HSS
TIN



35°

Technical Information

HSS = High-speed-steel
Form B = 5-pitch chamfer, spiral point for through holes
35° RSP = 2-pitch chamfer with 35° spiral flute for blind holes
DIN 371 / 376 • For metric ISO-thread DIN 13, tolerance 6H

Application

For cutting internal threads.

M	mm	mm	mm	mm	CODE	€	CODE	€
mit verstärktem Schaft - DIN 371								
M 3,0	0,50	2,50	11	56	11301		11351	
M 4,0	0,70	3,30	13	63	11302		11352	
M 5,0	0,80	4,20	16	70	11303		11353	
M 6,0	1,00	5,00	19	80	11304		11354	
M 8,0	1,25	6,75	22	90	11305		11355	
M 10,0	1,50	8,50	24	100	11306		11356	
mit durchfallendem Schaft - DIN 376								
M 12,0	1,75	10,25	29	110	11307		11357	
M 14,0	2,00	12,00	30	110	11308		11358	
M 16,0	2,00	14,00	32	110	11309		11359	
M 18,0	2,50	15,50	34	125	11310		11360	
M 20,0	2,50	17,50	34	140	11311		11361	
M 22,0	2,50	19,50	34	140	11312		11362	
M 24,0	3,00	21,00	38	160	11313		11363	

Metrisch | Metric

HSS-E
TIN



Form B

Technische Information

HSS-E = Hochleistungsschnell-Stahl Klasse E

HSS-E
TIN



35°

Technical Information

HSS-E = High-speed-steel E-class

M	mm	mm	mm	mm	CODE	€	CODE	€
mit verstärktem Schaft - DIN 371								
M 3,0	0,50	2,50	11	56	11321		11381	
M 4,0	0,70	3,30	13	63	11322		11382	
M 5,0	0,80	4,20	16	70	11323		11383	
M 6,0	1,00	5,00	19	80	11324		11384	
M 8,0	1,25	6,75	22	90	11325		11385	
M 10,0	1,50	8,50	24	100	11326		11386	
mit durchfallendem Schaft - DIN 376								
M 12,0	1,75	10,25	29	110	11327		11387	
M 14,0	2,00	12,00	30	110	11328		11388	
M 16,0	2,00	14,00	32	110	11329		11389	
M 18,0	2,50	15,50	34	125	11330		11390	
M 20,0	2,50	17,50	34	140	11331		11391	
M 22,0	2,50	19,50	34	140	11332		11392	
M 24,0	3,00	21,00	38	160	11333		11393	



Maschinengewindebohrer Sets

Machine Tap Sets

EVENTUS[®]
by EXACT

Metrisch | Metric

M
HSS TIN
Form B

M
HSS TIN
35°

Maschinengewindebohrer Machine Taps: M3 - M4 - M5 - M6 - M8 - M10 - M12	11314	

Maschinengewindebohrer Machine Taps: M3 - M4 - M5 - M6 - M8 - M10 - M12	11364	

Metrisch | Metric

M
HSS-E TIN
Form B

M
HSS-E TIN
35°

Maschinengewindebohrer Machine Taps: M3 - M4 - M5 - M6 - M8 - M10 - M12	11334	

Maschinengewindebohrer Machine Taps: M3 - M4 - M5 - M6 - M8 - M10 - M12	11394	

Maschinengewindebohrer • Machine Taps

Maschinengewindebohrer DIN 371/376

Machine Taps DIN 371/376

EVENTUS
by EXACT

Metrisch | Metric

HSS
TiAIN



Form B

HSS
TiAIN



35°

Technische Information

HSS = Hochleistungsschnell-Stahl
 Form B = 5 Gang Anschnitt mit Schälanschnitt, für Durchgangslöcher
 35° RSP = 2 Gang Anschnitt für Sacklöcher
 DIN 371 / 376 • Für metrisches ISO-Gewinde DIN 13, Toleranz 6H

Technical Information

HSS = High-speed-steel
 Form B = 5-pitch chamfer, spiral point for through holes
 35° RSP = 2-pitch chamfer with 35° spiral flute for blind holes
 DIN 371 / 376 • For metric ISO-thread DIN 13, tolerance 6H

Anwendung

Zum Schneiden von Innengewinden.

Application

For cutting internal threads.

M	mm	mm	mm	mm	CODE	€	CODE	€
mit verstärktem Schaft - DIN 371								
M 3,0	0,50	2,50	11	56	12301		12351	
M 4,0	0,70	3,30	13	63	12302		12352	
M 5,0	0,80	4,20	16	70	12303		12353	
M 6,0	1,00	5,00	19	80	12304		12354	
M 8,0	1,25	6,75	22	90	12305		12355	
M 10,0	1,50	8,50	24	100	12306		12356	
mit durchfallendem Schaft - DIN 376								
M 12,0	1,75	10,25	29	110	12307		12357	
M 14,0	2,00	12,00	30	110	12308		12358	
M 16,0	2,00	14,00	32	110	12309		12359	
M 18,0	2,50	15,50	34	125	12310		12360	
M 20,0	2,50	17,50	34	140	12311		12361	
M 22,0	2,50	19,50	34	140	12312		12362	
M 24,0	3,00	21,00	38	160	12313		12363	

Metrisch | Metric

HSS-E
TiAIN



Form B

HSS-E
TiAIN



35°

Technische Information

HSS-E = Hochleistungsschnell-Stahl Klasse E

Technical Information

HSS-E = High-speed-steel E-class

M	mm	mm	mm	mm	CODE	€	CODE	€
mit verstärktem Schaft - DIN 371								
M 3,0	0,50	2,50	11	56	12321		12381	
M 4,0	0,70	3,30	13	63	12322		12382	
M 5,0	0,80	4,20	16	70	12323		12383	
M 6,0	1,00	5,00	19	80	12324		12384	
M 8,0	1,25	6,75	22	90	12325		12385	
M 10,0	1,50	8,50	24	100	12326		12386	
mit durchfallendem Schaft - DIN 376								
M 12,0	1,75	10,25	29	110	12327		12387	
M 14,0	2,00	12,00	30	110	12328		12388	
M 16,0	2,00	14,00	32	110	12329		12389	
M 18,0	2,50	15,50	34	125	12330		12390	
M 20,0	2,50	17,50	34	140	12331		12391	
M 22,0	2,50	19,50	34	140	12332		12392	
M 24,0	3,00	21,00	38	160	12333		12393	



Maschinengewindebohrer Sets

Machine Tap Sets

EVENTUS[®]
by EXACT

Metrisch | Metric

Maschinengewindebohrer • Machine Taps

M	
HSS TiAlN	
Form B	

M	
HSS TiAlN	
35°	

Maschinengewindebohrer Machine Taps: M3 - M4 - M5 - M6 - M8 - M10 - M12	12314	

Maschinengewindebohrer Machine Taps: M3 - M4 - M5 - M6 - M8 - M10 - M12	12364	

Metrisch | Metric

M	
HSS-E TiAlN	
Form B	

M	
HSS-E TiAlN	
35°	

Maschinengewindebohrer Machine Taps: M3 - M4 - M5 - M6 - M8 - M10 - M12	12334	

Maschinengewindebohrer Machine Taps: M3 - M4 - M5 - M6 - M8 - M10 - M12	12394	





STUFEN- & BLECHSCHÄLBOHRER STEP DRILLS AND TUBE & SHEET DRILLS

EXACT®

ADVANCEDLINE® 4-Nuten Spiralbohrer

ADVANCEDLINE® 4-way flute Step Drill

- Qualitätsmerkmale und Vorteile
- HSS

158-159
160-161

Stufenbohrer

Step Drills

- Qualitätsmerkmale und Materialbearbeitung
- mit TiN-Beschichtung
- mit TiAlN-Beschichtung

162
162-163

Stufenbohrer mit Spiralnute

Step Drills with spiral flute

- 3-Flächenschaft
- ROTASTOP® Komfortschaft
- mit TiN-Beschichtung
- mit TiAlN-Beschichtung
- mit TITAN PRO-Beschichtung

164-165
166
169
171

Stufenbohrer für Kabelverschraubungen

Step Drills for Cable Connections

- Produktinformation
- mit TiN-Beschichtung
- mit TiAlN-Beschichtung

172
173

Fräs-Stufenbohrer

Step Drill and Milling Cutter

- mit TiN-Beschichtung
- mit TiAlN-Beschichtung

174-175

Stufenbohrer für Panzerrohrverschraubungen

Step Drills for reinforced pipework screw connections

- mit TiN-Beschichtung
- mit TiAlN-Beschichtung

176

Stufenbohrer für Leitplanken

Step Drills for guardrail systems

- mit TiCN-Beschichtung

177

Stufenbohrer-Bit

Step Drill Bit

- mit TiN-Beschichtung
- mit TiAlN-Beschichtung

178-179

Blechsälbohrer

Tube & Sheet Drills

- Qualitätsmerkmale und Materialbearbeitung
- vaporisiert
- TiN-Beschichtung
- TiAlN-Beschichtung

180
181-182

Blechsälbohrer mit Spiralnute

Tube & Sheet Drills with spiral flute

- ROTASTOP® Komfortschaft
- Qualitätsmerkmale und Materialbearbeitung
- mit TiN-Beschichtung
- mit TiAlN-Beschichtung
- mit TITAN PRO-Beschichtung

183
184
185
187



TEST THE BEST
ADVANCEDLINE®
THE STEP DRILL INNOVATION

NEUE TURBOSPITZE

Vereinfacht das Zentrieren und Anbohren deutlich bei gleichzeitig extremer Laufruhe während des Bohrvorgangs.

NEU

INNOVATIVE 4-FACH SPIRALNUTE

Die Kraftverteilung von **2** auf **4 Schneiden** revolutioniert den gesamten Bohrprozess und sorgt für ein deutlich verbessertes Bohrverhalten bei erheblich verringerten Verschleißigenschaften.

VERBESSERTE GEOMETRIE

Erhöht die Leistung nachhaltig und ermöglicht bis zu **30% schnelleres Bohren** und bis zu **50% höhere Standzeiten**.

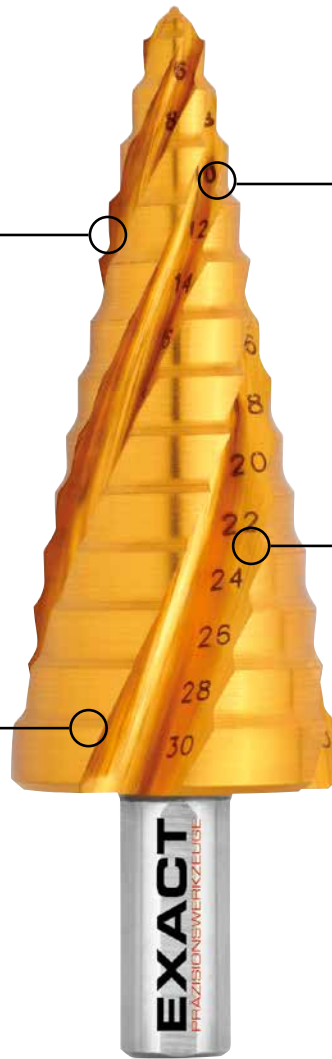

PATENTIERTER ROTASTOP®-SCHAFT

100% Sicherung gegen Durchdrehen des Bohrers im Bohrfutter bei optimaler Drehmomentübertragung.



MEHR POWER

Qualitätsmerkmale | Quality signs

Merkmale / Feature	Vorteile / Advantages	Nutzen / Benefit
 <p>Innovative 4-Fach Spiralnute Innovative 4-way spiral flute</p>	<ul style="list-style-type: none"> Kraftverteilung von 2 auf 4 Schneiden Verbessertes Bohrverhalten Verringerte Verschleißigenschaften Force distribution on 4 instead of 2 cutting edges Improved drilling behavior 	<p>bis zu / up to</p> <p>+30 %</p> <p>schnelleres Bohren faster drilling process</p>
 <p>Neue Turbospitze New "Turbo Tip"</p>	<ul style="list-style-type: none"> Vereinfacht das Zentrieren und Anbohren Extrem ruhiger Lauf Significantly simplifies centering and drilling Extremely smooth operation 	<p>bis zu / up to</p> <p>+50 %</p> <p>höhere Standzeit longer service life</p>
 <p>Patentierter ROTASTOP®-Schaft Patented ROTASTOP®-Shaft (optional)</p>	<ul style="list-style-type: none"> Beste Drehmomentübertragung Kein Durchrutschen im Bohrfutter Best torque transmission No slipping in the drill chuck 	<p>100 %</p> <p>Sicherung gegen Durchdrehen protection against slipping in the chuck</p>

EXACT
Innovation

ADVANCEDLINE®

DIE BOHRER INNOVATION

EXACT
PRÄZISIONSWERKZEUGE

Stufenbohrer | Step Drills

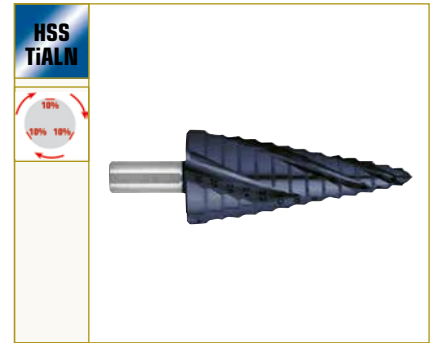
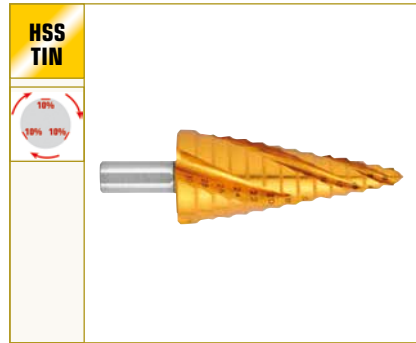
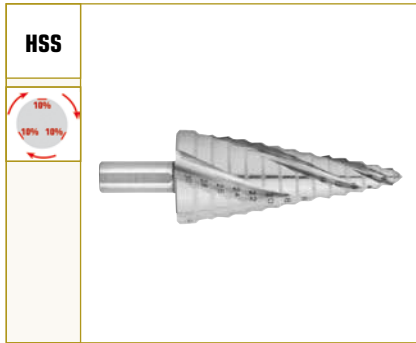

Technische Information

HSS = Hochleistungsschnell-Stahl
Mit 3-Flächenschaft

Technical Information

HSS = High-speed-steel
With 3-flats shaft

MEHR POWER

Vorteile | Advantages

- +** bis zu **30%** schnelleres Bohren
- +** bis zu **50%** höhere Standzeiten
- +** extrem ruhiger Lauf
- +** optimale Bohrerergebnisse

- +** up to **30%** faster drilling process
- +** up to **50%** longer service life
- +** extremely smooth operation
- +** perfect drilling results

mm				mm		CODE	€	CODE	€	CODE	€
4-12	4	66	6	Bohrstufen 1 mm steigend 4-5-6-7-8-9-10-11-12		07051		07056		07061	
4-20	4	70	8	2 mm steigend 4-6-8-10-12-14-16-18-20		07052		07057		07062	
6-30	4	94	10	6-8-10-12-14-16-18-20-22-24-26-28-30		07053		07058		07063	

Einsatz Stufenbohrer | Application Step Drills

	Baustahl Structural steel ≤ 500 N/mm ₂	Baustahl Structural steel > 500 N/mm ₂	Auto- matenstahl Free- cutting steel ≤ 1000 N/mm ₂	Ver- gütungs- stahl Tempered steel ≤ 1000 N/mm ₂	Legierter Stahl Alloyed steel ≤ 1200 N/mm ₂	VA Stahl VA steel ≤ 850 N/mm ₂	VA Stahl VA steel > 850 N/mm ₂	Werk- zeugstahl Tool steel ≤ 1000 N/mm ₂	Guss Cast iron ≤ 300 HB	Alu + Legierung Aluminium + alloy ≤ 450 N/mm ₂	Uni Uni	Schneidöl Cutting oil	Emulsion Emulsion	Minimal Schmie- rung Minimum lubrication	Trocken- bearbei- tung Dry machining	Pressluft Com- pressed air
	●	●	○			○				●	○	●	●		○	
	●	●	●	○		○				●	○	●	●			
	●	●	●	●	●	●	●	●	○	○	○			○	●	○

● empfohlen | recommended ○ bedingt geeignet | partly suitable

Kegelsenker • Countersinks

Sets Stufenbohrer | Sets Step Drills



NEU

INHALT 	CODE HSS	€ SET
4-12 / 4-20 / 6-30	07054	



NEU

INHALT 	CODE HSS	€ SET
4-12 / 4-20 / 6-30	07059	

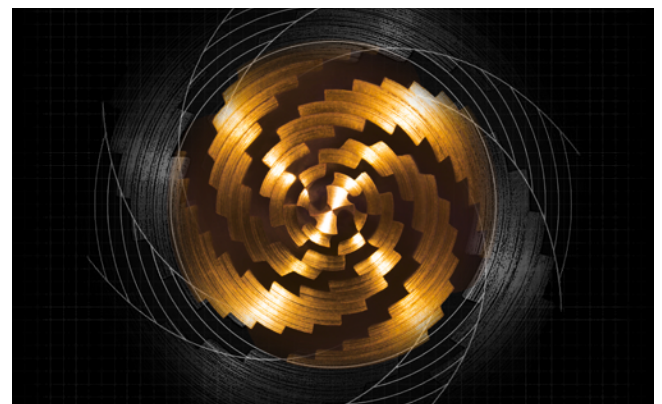

NEU

INHALT 	CODE HSS	€ SET
4-12 / 4-20 / 6-30	07064	



**Schneidöl-Spray & Bohrpaste siehe Seite 98
Cutting spray & drilling paste, see page 98**

Stufenbohrer Step Drills

HSS | HSS



Technische Information

HSS = Hochleistungsschnell-Stahl

Technical Information

HSS = High-speed-steel

TiN Zusätzliche Oberflächenhärtung:

- Oberflächenhärte ca. 2.500 HV
- Schichtstärke bis 2 µm
- Für harte Materialien
- Erhöhte Standzeiten
- Höhere Schnittgeschwindigkeit
- Temperaturbeständig bis 600° C
- Reduziert Kaltaufschweißung

Additional surface hardness:

- Surface treatment approx. 2.500 HV
- Layer Thickness up to 2 µm
- For hard materials
- Higher tool life
- Higher cutting speeds
- Temperature resistant up to 600° C
- Reduces cold weldings

- ### TiAIN
- Oberflächenhärte ca. 3.500 HV
 - Schichtstärke bis 4 µm
 - Für besonders harte Materialien
 - Optimale Standzeiten
 - Höchste Schnittgeschwindigkeit
 - Temperaturbeständig bis 800° C, kein Kühlmittel notwendig
 - Reduziert Kaltaufschweißung

- Surface treatment approx. 3.500 HV
- Layer Thickness up to 4 µm
- For hardest materials
- Optimized tool life
- Highest cutting speeds
- Temperature resistant up to 800° C, cooling not necessary
- Reduces cold weldings

Qualitätsmerkmale Quality characteristics



Made in Germany



Laserskalierung der Loch-Ø + Drehzahlangaben
Hole- and speed-diameter laser engraved on the tool



Kreuzanschliff
Split Point

Anwendung

Für gratfreies Bohren und Aufreiben von Blechen, Rohren und Profilen und einseitiges Entgraten in einem Arbeitsgang.

Application

For drilling and reaming freely of burrs of sheet steel, thin-walled tubes and structural steel shapes and deburring of one side in one step.

10%		mm		mm		mm		CODE	€	CODE	€	CODE	€
4-12	5	80	6	Bohrstufen 1 mm steigend 4-5-6-7-8-9-10-11-12				05321		05343		50061	
12-20	4	76	9	12-13-14-15-16-17-18-19-20				05322		05344		50062	
20-30	4	88	12	20-21-22-23-24-25-26-27-28-29-30				05323		05345		50063	
30-40	4	98	13	30-31-32-33-34-35-36-37-38-39-40				05324		05346		50064	
40-50	4	107	13	40-41-42-43-44-45-46-47-48-49-50				05325		05353		50065	
50-60	4	120	13	50-51-52-53-54-55-56-57-58-59-60				05326		05354		50066	
4-20	4	67	8	2 mm steigend 4-6-8-10-12-14-16-18-20				05328		05347		50067	
6-30	4	98	10	6-8-10-12-14-16-18-20-22-24-26-28-30				05329		05348		50068	
9-36	3	86	12	3 mm steigend 9-12-15-18-21-24-27-30-33-36				05330		05349		50069	

Einsatz Stufenbohrer | Application Step Drills

	Baustahl Structural steel ≤ 500 N/mm ₂	Baustahl Structural steel > 500 N/mm ₂	Auto- matenstahl Free- cutting steel ≤ 1000 N/mm ₂	Ver- gütungs- stahl Tempered steel ≤ 1000 N/mm ₂	Legierter Stahl Alloyed steel ≤ 1200 N/mm ₂	VA Stahl VA steel ≤ 850 N/mm ₂	VA Stahl VA steel > 850 N/mm ₂	Werk- zeugstahl Tool steel ≤ 1000 N/mm ₂	Guss Cast iron ≤ 300 HB	Alu + Legierung Aluminium + alloy ≤ 450 N/mm ₂	Uni Uni	Schneidöl Cutting oil	Emulsion	Minimal Schmie- rung Minimum lubrication	Trocken- bearbei- tung Dry machining	Pressluft Com- pressed air
	●	●	○			○				●	○	●	●		○	
	●	●	●	○		○				●	○	●	●			
	●	●	●	●	●	●	●	●	○	○	○			○	●	○

● empfohlen | recommended ○ bedingt geeignet | partly suitable

Sets HSS | Sets HSS

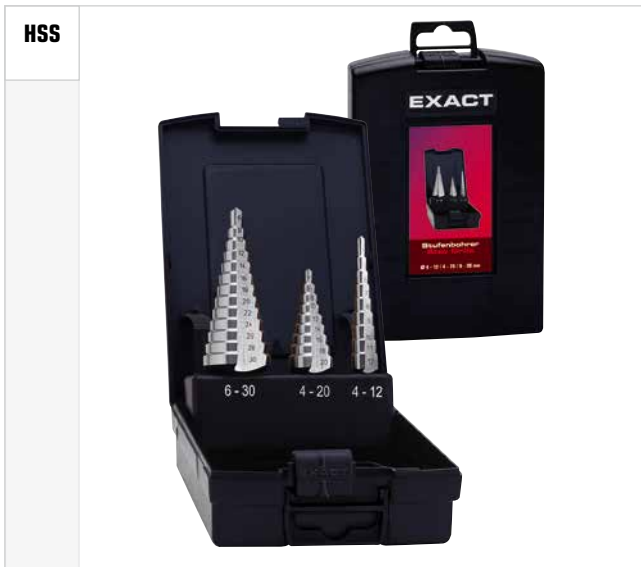

3-Flächenschaft | 3-flats shaft

	<p>INHALT</p>	<p>CODE</p>	<p>€ SET</p>
	<p>4-12 / 12-20 / 20-30</p>	<p>05331</p>	
	<p>4-12 / 4-20 / 6-30</p>	<p>05332</p>	



3-Flächenschaft | 3-flats shaft

	<p>INHALT</p>	<p>CODE</p>	<p>€ SET</p>
	<p>4-12 / 12-20 / 20-30</p>	<p>05350</p>	
	<p>4-12 / 4-20 / 6-30</p>	<p>05351</p>	

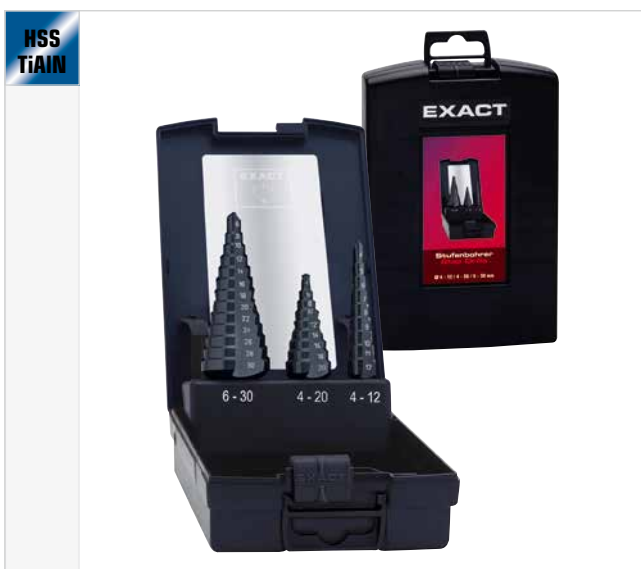

3-Flächenschaft | 3-flats shaft

	<p>INHALT</p>	<p>CODE</p>	<p>€ SET</p>
	<p>4-12 / 12-20 / 20-30</p>	<p>50070</p>	
	<p>4-12 / 4-20 / 6-30</p>	<p>50071</p>	

Schneidöl-Spray & Bohrpaste siehe Seite 98
Cutting spray & drilling paste, see page 98

Stufenbohrer mit Spiralnute

Step Drills with spiral flute

Qualitätsmerkmale | Quality characteristics



Mit Titan-Nitrid Beschichtung
With titanium-nitride coating



Mit Titan-Aluminium-Nitrid Beschichtung
With titanium-aluminum-nitride coating



Kreuzanschliff Split Point
Kantenbrecher Edge-Breaker
Variable Spiralnute Variable spiral flute
Laserskalierung Loch-Ø Hole-diameter laser engraved on the tool
Laserskalierung Drehzahlen Rotation speed laser engraved
Mit 3-Flächenschaft With 3-flats shaft

Stufenbohrer • Step Drills

TIN

Zusätzliche Oberflächenhärtung:

- Oberflächenhärte ca. 2.500 HV
- Schichtstärke bis 2 µm
- Für harte Materialien
- Erhöhte Standzeiten
- Höhere Schnittgeschwindigkeit
- Temperaturbeständig bis 600° C
- Reduziert Kaltaufschweißung

Additional surface hardness:

- Surface treatment approx. 2.500 HV
- Layer Thickness up to 2 µm
- For hard materials
- Higher tool life
- Higher cutting speeds
- Temperature resistant up to 600° C
- Reduces cold weldings



Made in Germany

EXACT Innovation



Mit Spiralnute | Spiral flute



Laserskalierung der Loch-Ø + Drehzahlangaben
Hole- and speed-diameter laser engraved on the tool



Kantenbrecher
Edge-Breaker

TiAIN

- Oberflächenhärte ca. 3.500 HV
- Schichtstärke bis 4 µm
- Für besonders harte Materialien
- Optimale Standzeiten
- Höchste Schnittgeschwindigkeit
- Temperaturbeständig bis 800° C, kein Kühlmittel notwendig
- Reduziert Kaltaufschweißung

- Surface treatment approx. 3.500 HV
- Layer Thickness up to 4 µm
- For hardest materials
- Optimized tool life
- Highest cutting speeds
- Temperature resistant up to 800° C, cooling not necessary
- Reduces cold weldings

Anwendung | Application

Für gratfreies Bohren und Aufreiben von Blechen, Rohren und Profilen.
For drilling and reaming freely of burs of sheet steel, thin-walled tubes and structural steel shapes.

Einsatz Stufenbohrer | Application Step Drills

	Baustahl Structural steel ≤ 500 N/mm ₂	Baustahl Structural steel > 500 N/mm ₂	Auto- matenstahl Free- cutting steel ≤ 1000 N/mm ₂	Ver- gütungs- stahl Tempered steel ≤ 1000 N/mm ₂	Legierter Stahl Alloyed steel ≤ 1200 N/mm ₂	VA Stahl VA steel ≤ 850 N/mm ₂	VA Stahl VA steel > 850 N/mm ₂	Werk- zeugstahl Tool steel ≤ 1000 N/mm ₂	Guss Cast iron ≤ 300 HB	Alu + Legierung Aluminium + alloy ≤ 450 N/mm ₂	Uni Uni	Schneidöl Cutting oil	Emulsion	Minimal Schmie- rung Minimum lubrication	Trocken- bearbei- tung Dry machining	Pressluft Com- pressed air
	●	●	○			○				●	○	●	●		○	
	●	●	●	○		○				●	○	●	●			
	●	●	●	●	●	●	●	●	○	○	○			○	●	○

● empfohlen | recommended ○ bedingt geeignet | partly suitable





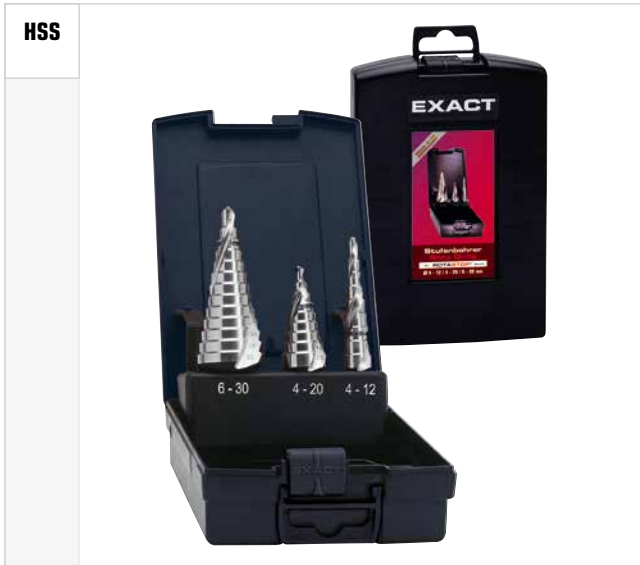

Stufenbohrer mit Spiralnute

Step Drills with spiral flute

Sets HSS | Sets HSS



3-Flächenschaft | 3-flats shaft

	INHALT		CODE	€ SET
	4-12	Bohrstufen 1 mm steigend	07026	
	4-20	Bohrstufen 2 mm steigend	07027	
	6-30	Bohrstufen 2 mm steigend	07028	
	6-36	Bohrstufen 3 mm steigend	07030	
	4-12 / 4-20 / 6-30		07029	







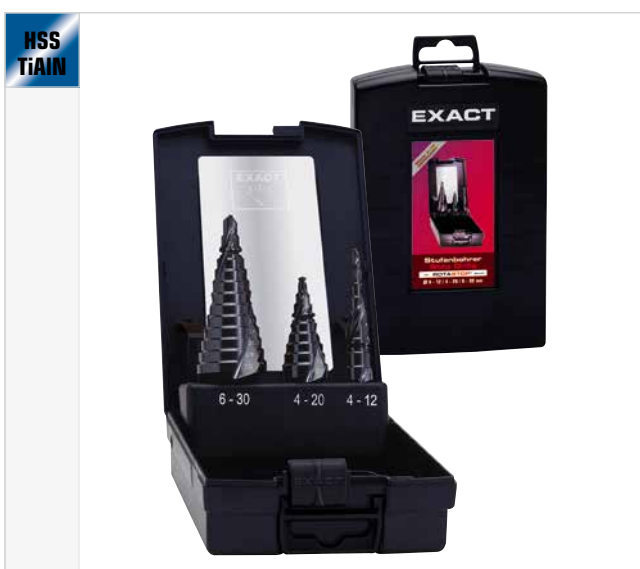

3-Flächenschaft | 3-flats shaft

	INHALT		CODE	€ SET
	4-12	Bohrstufen 1 mm steigend	07031	
	4-20	Bohrstufen 2 mm steigend	07032	
	6-30	Bohrstufen 2 mm steigend	07033	
	6-36	Bohrstufen 3 mm steigend	07035	
	4-12 / 4-20 / 6-30		07034	



3-Flächenschaft | 3-flats shaft

	INHALT		CODE	€ SET
	4-12	Bohrstufen 1 mm steigend	07036	
	4-20	Bohrstufen 2 mm steigend	07037	
	6-30	Bohrstufen 2 mm steigend	07038	
	6-36	Bohrstufen 3 mm steigend	07040	
	4-12 / 4-20 / 6-30		07039	

Innovativer Komfortschaft | Innovated convenience shaft



Für verbesserte Drehmomentübertragung.

For improved torque transfer.

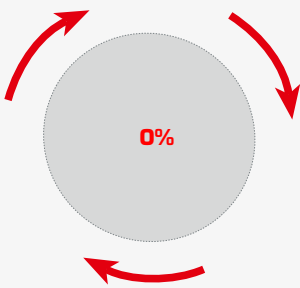

Der Zylinder-Schaft

Weniger geht nicht: **0 %** der Form bieten Flächen zum Einspannen im Bohrfutter. Eine optimale Drehmomentübertragung kann nicht erfolgen.

Das Resultat:

Der Schaft neigt zum Durchrutschen im Bohrfutter. Vor allen Dingen bei Werkzeugen, bei denen der Schaftdurchmesser kleiner ist, als der Durchmesser des eigentlichen Arbeitsbereichs (z.B. Schälbohrer, Stufenbohrer oder Senker).

The cylindrical shaft

The absolute minimum: **0 %** of its contour consists of surfaces designed for firmer chucking. So optimum transmission of the torque is not possible.

The result:

The shaft tends to slip in the chuck, where the diameter of the shaft is smaller than the diameter of the working part of the tool (especially in the case of tools such as roughing drills, step drills or countersinks).

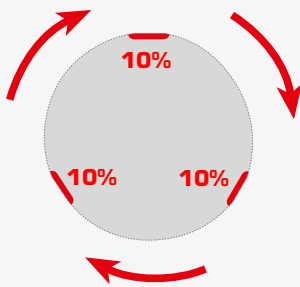

Der 3-Flächen-Schaft

Nur **30 %** der Form ermöglichen durch abgeflachte Kanten eine gute Drehmomentübertragung.

Das Resultat:

Der Schaft verhindert das Durchrutschen im Bohrfutter. Die Ergebnisse sind nicht optimal.

Das Werkzeugwechseln ist bei optimalem Einspannen zeitaufwendig.

The three-flats shaft

Only **30 %** of the contour permits good transmission of the torque by means of flats.

The result:

The shaft prevents slipping in the chuck despite the flats. Optimum results are not achieved.

Changing tools is time-consuming for perfect chucking.

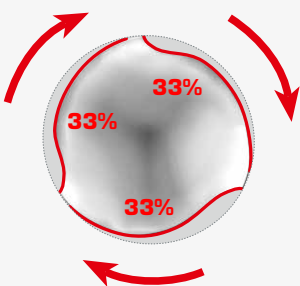

ROTA STOP® – Die Kraft der Form

Die Form von ROTA STOP® garantiert eine verbesserte Drehmomentübertragung, da sich ROTA STOP® durch ansteigende Formen praktisch selbst im Bohrfutter spannt.

Das Resultat:

Kein Durchrutschen im Bohrfutter. Präzise Ergebnisse bei der Metallbearbeitung.

ROTA STOP® ermöglicht ein einfaches Werkzeugwechseln und längere Einsatzzeiten für die Werkzeuge.

ROTA STOP® – Strength from the contour

The contour of the ROTA STOP® tool bit ensures improved transmission of the torque; ROTA STOP® practically chucks itself automatically, by means of the rising contours.

The result:

No slipping in the chuck, and precise results when machining metals.

ROTA STOP® allows easy tool changing and longer service lives for the tools.

INNOVATION BY

EXACT
PRÄZISIONSWERKZEUGE

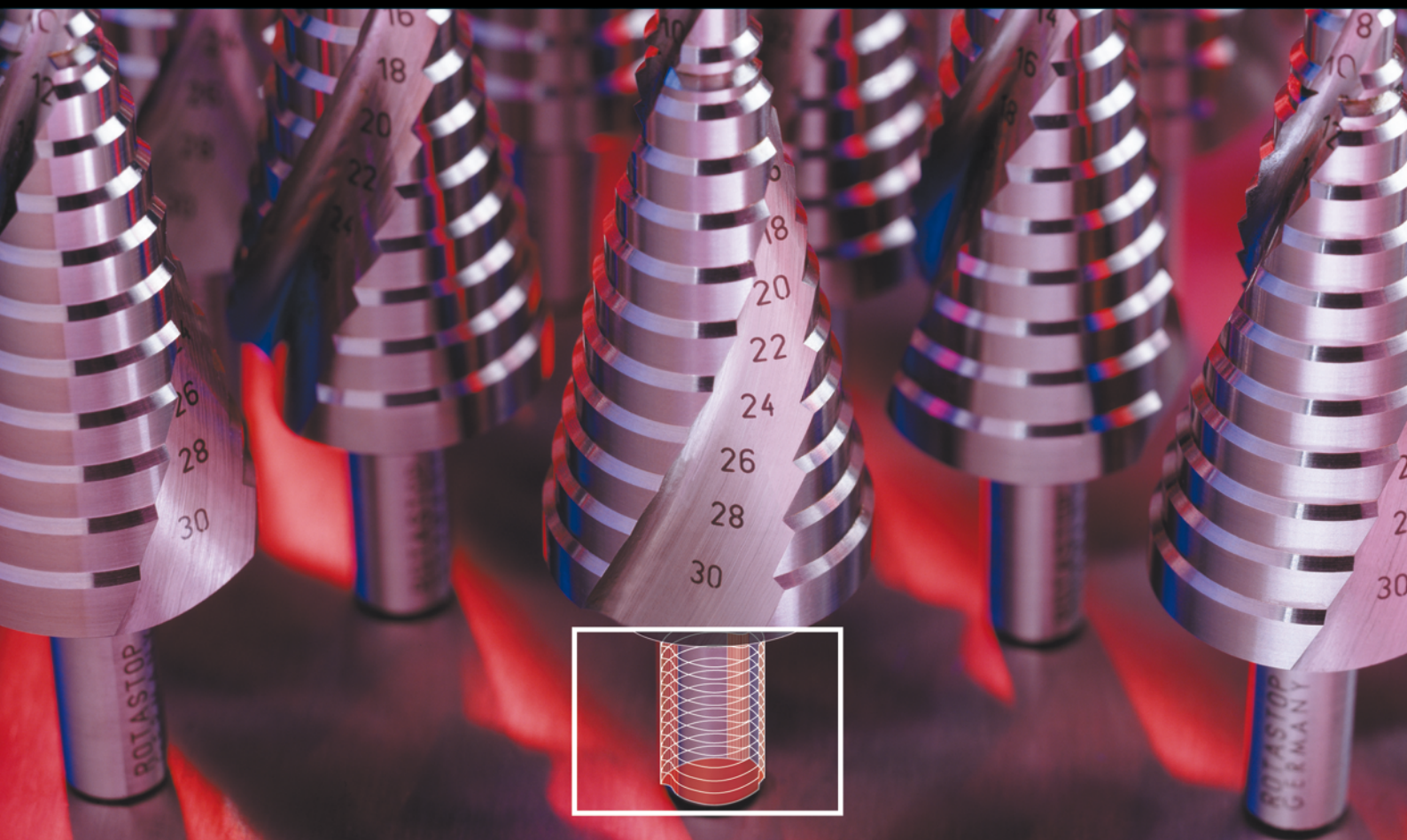

ROTASTOP®-SCHAFT

INNOVATION | INNOVATION



Durch ansteigende Formen spannt sich ROTASTOP® selbst im Bohrfutter
ROTASTOP® chucks itself automatically by rising contours

- Alle EXACT Stufenbohrer und Blechschälbohrer mit Spiralnute verfügen über ROTASTOP®-Schaft
- All EXACT Step-, Tube & Sheet Drills with spiral flute

VORTEILE | ADVANTAGES

- Kein Durchrutschen im Bohrfutter
- ROTASTOP® spannt sich selbst im Bohrfutter
- Optimale Drehmomentübertragung
- Präzise Ergebnisse
- Einfacher Werkzeugwechsel

- **No slipping in the chuck**
- **ROTASTOP® chucks itself automatically**
- **Optimum transmission of the torque**
- **Precise results**
- **Easy tool changing**

Stufenbohrer mit Spiralnute

Step Drills with spiral flute

Qualitätsmerkmale | Quality characteristics



Mit Titan-Nitrid Beschichtung
With titanium-nitride coating



Mit Titan-Aluminium-Nitrid Beschichtung
With titanium-aluminium-nitride coating



Kreuzanschliff Split Point
Kantenbrecher Edge-Breaker
Variable Spiralnute Variable spiral flute
Laserskalierung Loch-Ø Hole-diameter laser engraved on the tool
Laserskalierung Drehzahlen Rotation speed laser engraved

Mit ROTASTOP®-Komfortschaft
With ROTASTOP®-convenience shaft

TIN

Zusätzliche Oberflächenhärtung:

- Oberflächenhärte ca. 2.500 HV
- Schichtstärke bis 2 µm
- Für harte Materialien
- Erhöhte Standzeiten
- Höhere Schnittgeschwindigkeit
- Temperaturbeständig bis 600° C
- Reduziert Kaltaufschweißung

Additional surface hardness:

- Surface treatment approx. 2.500 HV
- Layer Thickness up to 2 µm
- For hard materials
- Higher tool life
- Higher cutting speeds
- Temperature resistant up to 600° C
- Reduces cold weldings



Made in Germany

EXACT Innovation



ROTASTOP® Komfortschaft
ROTASTOP® convenience shaft
(S. 166/167)

TiAIN

- Oberflächenhärte ca. 3.500 HV
- Schichtstärke bis 4 µm
- Für besonders harte Materialien
- Optimale Standzeiten
- Höchste Schnittgeschwindigkeit
- Temperaturbeständig bis 800° C, kein Kühlmittel notwendig
- Reduziert Kaltaufschweißung

- Surface treatment approx. 3.500 HV
- Layer Thickness up to 4 µm
- For hardest materials
- Optimized tool life
- Highest cutting speeds
- Temperature resistant up to 800° C, cooling not necessary
- Reduces cold weldings



Mit Spiralnute | Spiral flute



Laserskalierung der Loch-Ø + Drehzahlangaben
Hole- and speed-diameter laser engraved on the tool



Kantenbrecher
Edge-Breaker

Anwendung | Application

Für gratfreies Bohren und Aufreiben von Blechen, Rohren und Profilen.
For drilling and reaming freely of burs of sheet steel, thin-walled tubes and structural steel shapes.

Einsatz Stufenbohrer | Application Step Drills

	Baustahl Structural steel ≤ 500 N/mm ₂	Baustahl Structural steel > 500 N/mm ₂	Auto- matenstahl Free- cutting steel ≤ 1000 N/mm ₂	Ver- gütungs- stahl Tempered steel ≤ 1000 N/mm ₂	Legierter Stahl Alloyed steel ≤ 1200 N/mm ₂	VA Stahl VA steel ≤ 850 N/mm ₂	VA Stahl VA steel > 850 N/mm ₂	Werk- zeugstahl Tool steel ≤ 1000 N/mm ₂	Guss Cast iron ≤ 300 HB	Alu + Legierung Aluminium + alloy ≤ 450 N/mm ₂	Uni Uni	Schneidöl Cutting oil	Emulsion Emulsion	Minimal Schmie- rung Minimum lubrication	Trocken- bearbei- tung Dry machining	Pressluft Com- pressed air
	●	●	○			○				●	○	●	●		○	
	●	●	●	○		○				●	○	●	●			
	●	●	●	●	●	●	●	●	○	○	○			○	●	○

● empfohlen | recommended ○ bedingt geeignet | partly suitable

Stufenbohrer mit Spiralnute

Step Drills with spiral flute

Sets HSS | Sets HSS

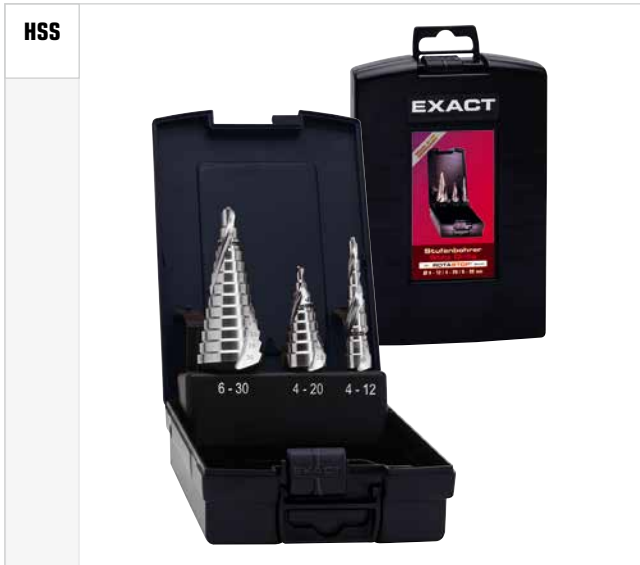

ROTASTOP®-Schaft | -shaft

ROTASTOP	INHALT		CODE	€ SET
	4-12	Bohrstufen 1 mm steigend	07001	
	4-20	Bohrstufen 2 mm steigend	07002	
	6-30	Bohrstufen 2 mm steigend	07003	
	6-36	Bohrstufen 3 mm steigend	07005	
	4-12 / 4-20 / 6-30		07004	

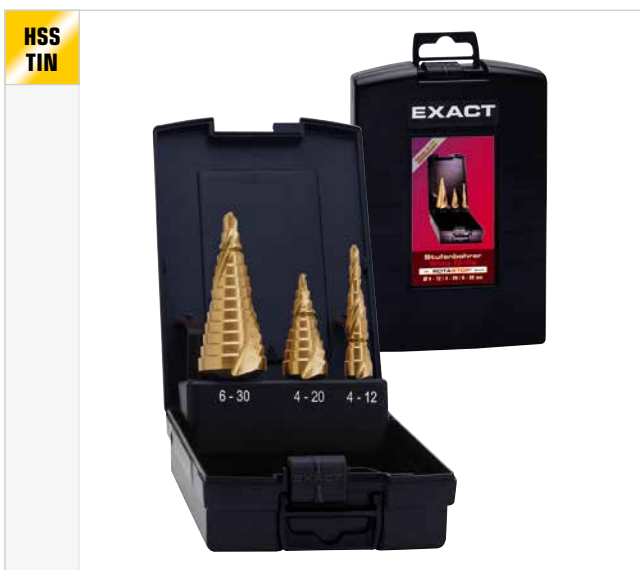

ROTASTOP®-Schaft | -shaft

ROTASTOP	INHALT		CODE	€ SET
	4-12	Bohrstufen 1 mm steigend	07011	
	4-20	Bohrstufen 2 mm steigend	07012	
	6-30	Bohrstufen 2 mm steigend	07013	
	6-36	Bohrstufen 3 mm steigend	07015	
	4-12 / 4-20 / 6-30		07014	

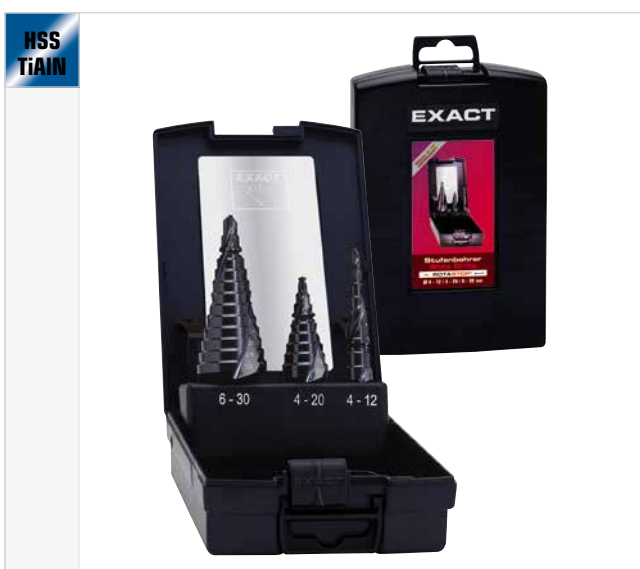

ROTASTOP®-Schaft | -shaft

ROTASTOP	INHALT		CODE	€ SET
	4-12	Bohrstufen 1 mm steigend	07021	
	4-20	Bohrstufen 2 mm steigend	07022	
	6-30	Bohrstufen 2 mm steigend	07023	
	6-36	Bohrstufen 3 mm steigend	07025	
	4-12 / 4-20 / 6-30		07024	

EXACT
Innovation

EXACT
COATING TECHNOLOGIE

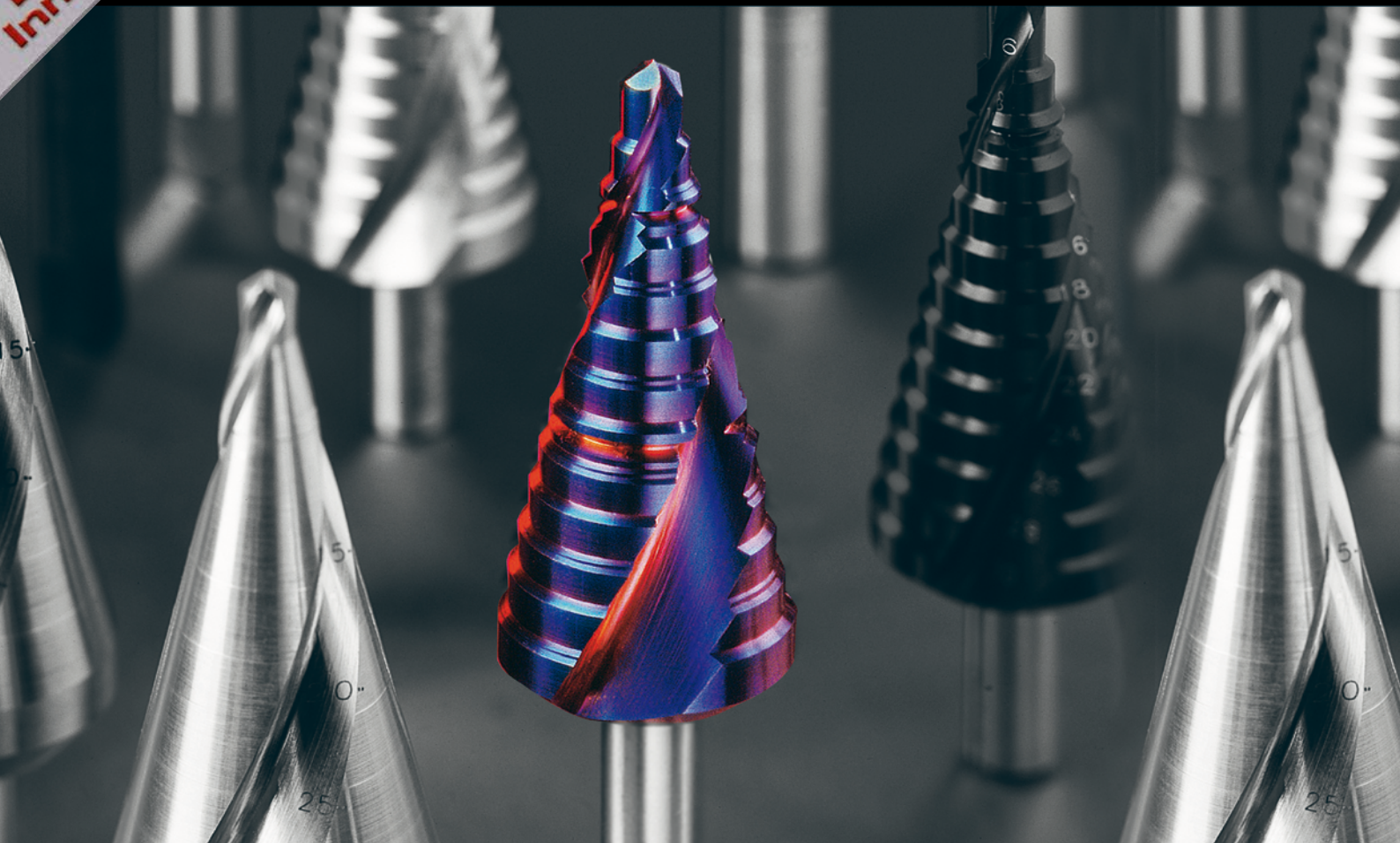

TITAN PRO

Beschichtung | Coating

BESCHREIBUNG

Diese Neuentwicklung ist eine TIALN / TIN Kombinationsschicht und verfügt über ein sehr gutes Verschleißverhalten, sowie gute thermische Stabilität. TITAN-PRO Beschichtungen sind universell einsetzbar und für die Bearbeitung von hochfesten Materialien geeignet.

DESCRIPTION

This new development is a combination of TIALN and TIN coating. It combines excellent wear resistance with good thermal stability. TITAN-PRO coating can be used universally and its suitable for high-strength materials.

TECHNISCHE INFORMATION

Beschichtungsmaterial: TIALN / TIN
Schichtfarbe: Violett
Schichtstruktur: Multilayer
Schichtstärke: bis 2 µm
Oberflächenhärte: ca. 3100 HV
Anwendungstemperatur: bis 650 °C

TECHNICAL INFORMATION

Coating: TIALN / TIN
Layer colour: Violett
Layer: multilayer
Layer thickness: up to 2 µm
Surface hardness: ca. 3100 HV
Temperature: up to 650 °C

VORTEILE

- **Optimale Standzeiten**
- **Geringer Reibungskoeffizient**
- **Höhere Schnittgeschwindigkeit**
- **Prozesskostenoptimierung**
- **Ca. 25 % mehr Leistung**

ADVANTAGES

- **Optimum service life**
- **A low coefficient of friction**
- **Higher cutting speed**
- **Process cost optimisation**
- **Appr. 25% higher performance**

Stufenbohrer mit Spiralnute | **Step Drills with spiral flute**

HSS TitanPro	
4-12	

HSS TitanPro	
4-20	

HSS TitanPro	
6-30	

ROTASTOP®-Schaft | **-shaft**

	 
4-12 Bohrstufen 1 mm steigend	09011

ROTASTOP®-Schaft | **-shaft**

	 
4-20 Bohrstufen 2 mm steigend	09012

ROTASTOP®-Schaft | **-shaft**

	 
6-30 Bohrstufen 2 mm steigend	09013

Stufenbohrer • Step Drills



Anwendung | **Application**

Für gratfreies Bohren und Aufreiben von Blechen, Rohren und Profilen.
For drilling and reaming freely of burrs of sheet steel, thin-walled tubes and structural steel shapes.

Set | **Set**

HSS TitanPro	
------------------------	---

ROTASTOP®-Schaft | **-shaft**

	 
4-12 / 4-20 / 6-30	09014

Produktinformation | Product information



Artikel für Kabelverschraubungen

Die Gewinde sind metrische ISO-Feingewinde, jeweils mit einer Steigung von 1,5 mm bei allen Maßen. Bei Verteilerschränken mit Wandstärken bis max. 3 - 5,5 mm, werden die Kabelverschraubung in das Gehäuse verschraubt. Mit einem unserer Stufenbohrer wird, wie unten beschrieben, das Gewindekernloch gebohrt. Für das entsprechende Gewinde haben wir Spezial-Einschnitt-Gewindebohrer entwickelt (M 12 - M 32). Unsere Einschnitt-Gewindebohrer verfügen über eine lange Pilotspitze mit der das Werkzeug in der Bohrung fixiert wird, um ein 100% fluchtendes Gewinde auch bei einseitigem Druck zu erzeugen. Den Antrieb des Gewindebohrers haben wir so konstruiert, daß man ihn mit einem handelsüblichen Sechskanteinsatz („Nuß“) und einer Knarre im Einhandbetrieb betätigen kann. Diese Art des Antriebes ist zeit- und platzsparend, im Vergleich zu einem Einsatz mit DIN Handgewindebohrern und Windeisen (Ausladung des Windeisens bis zu 75 cm).

EXACT Stufenbohrer HSS mit Spiralnute und „Kantenbrecher“ Zone (DBGM) decken das gesamte Spektrum der Gehäuse-Öffnungen der neuen Norm M12 bis M 32 (EC 10) bzw. M 12 bis M 40 (EC 20) ab. Die Stufenbohrer haben jeweils eine kurze (3 mm) Bohrstufe für die Kabeldurchlässe in dünnwandige Gehäuse (Wandstärke max. 2 mm), sowie eine lange (6mm) Bohrstufe für Gewindekernlöcher in Verteilerschränken (Wandstärke max. 3 - 5,5 mm). Je nach Anwendungsintensität bieten wir die Stufenbohrer in blanker Ausführung, sowie mit TiN (Titan-Nitrid) und TiAlN (Titan-Aluminium-Nitrid) Beschichtungen an. Vorteile, speziell der EXACT-Stufenbohrer: Mit der spiralförmigen Nute (DBGM) erhalten wir ein verbessertes Arbeitsergebnis durch optimale Spanabfuhr, ruhigeres Schneidverhalten, längere Lebensdauer auf Grund verlängerter Schneidkanten, und weniger Kratzer auf dem Material durch kontrollierte Spanabfuhr. Mit Hilfe des „Kantenbrechers“ (DBGM) ist es möglich, die Bohrungen in Gehäusen (bis 1,5 mm Materialstärke) von beiden Seiten in einem Arbeitsgang zu entgraten. Der Einsatz eines zusätzlichen Entgratwerkzeuges wird überflüssig.

Articles for Cable Connections

The threads are metric ISO-fine threads, each with a 1.5 pitch for all sizes. Cable screw connections are screwed into the cabinets with wall depths up to max. 3 - 5.5 mm. The core hole is drilled, as described below, with one of our step drills. We have designed a special short Tap (M 12 – M 32) for the respective threads. Our special short Taps are designed with a long pilot guide which fixes the tool in the bore, thus enabling the generating of threads which are 100% aligned even with single-sided pressure. We have designed the tap's drive such that one can use it single-handedly with a commercially available hex-head insert (nut) and a ratchet. This type of drive is time and space-saving when compared to DIN hand taps and tap wrenches (tap wrench swings of up to 750 mm).

EXACT HSS step drills with spiral flute and “Edge Breaker” zone (DBGM) cover the complete spectrum of electrician holes as per the new M12 to M32 (EC 10) specification, alternatively M 12 to M 40 (EC 20). The step drills have a short (3 mm) drill step for cable through-holes of thin-walled cabinets (max. 2 mm wall depth) as well as a long (6mm) drill step for tapping core holes in distributor cabinets (max. 3 - 5.5 mm wall depth) for every one of the individual metric diameters. We offer application-oriented step drills, e.g. without coating or as well as TiN (titanium-nitride) and TiAlN (titanium-aluminium-nitride) coated designs. Especial advantage of the EXACT-step drills: the spiral shaped flute (DBGM) enables an improved machining result due to optimal chip removal, smoother cutting characteristics, increased life-span due to increased cutting-edge lengths and scratches on the material due to controlled chip removal. Using the “Edge Breaker” (DBGM) capability it is possible to deburr the cabinet bores (up to 1.5 mm material thickness) from both sides in one machining step, thus eliminating the need for an extra deburring tool.

Gewinde Kernloch (6 mm Stufenhöhe)

∅	7	10.5	14.5	18.5	23.5	30.5
Gewinde	-	M12x1.5	M16x1.5	M20x1.5	M25x1.5	M32x1.5

Durchgangslöcher (3 mm Stufenhöhe)

∅	12.5	16.5	20.5	25.5	32.5
Gewinde	M12x1.5	M16x1.5	M20x1.5	M25x1.5	M32.5x1.5

Thread Core Hole (6 mm Steps)

∅	7	10.5	14.5	18.5	23.5	30.5
Thread	-	M12x1.5	M16x1.5	M20x1.5	M25x1.5	M32x1.5

Trough Holes (3 mm Steps)

∅	12.5	16.5	20.5	25.5	32.5
Thread	M12x1.5	M16x1.5	M20x1.5	M25x1.5	M32.5x1.5

Stufenbohrer für Kabelverschraubungen

Step Drills for Cable Connections

HSS | HSS



Technische Information

HSS = Hochleistungsschnell-Stahl

Anwendung

Für gratfreies Bohren und Aufreiben von Kabelrohrverschraubungen

Technical Information

HSS = High-speed-steel

Application

For drilling and reaming freely of cable connections

Mit ROTASTOP® Komfortschaft | With convenience shaft

ROTA STOP	mm	mm	mm	mm	CODE	€	CODE	€	CODE	€
EC 10	6	96	12	Gewinde Kernlöcher für Kabelverschraubungen 7 10,5 14,5 18,5 23,5 30,5 - M12x1,5 M16x1,5 M20x1,5 M25x1,5 M32x1,5 Durchgangslöcher für Kabelverschraubungen 7 12,5 16,5 20,5 25,5 32,5 - M12x1,5 M16x1,5 M20x1,5 M25x1,5 M32x1,5	05310		05313		05316	
7-32,5	3									
EC 20	6	110	12	Gewinde Kernlöcher für Kabelverschraubungen 7 10,5 14,5 18,5 23,5 30,5 38,5 - M12x1,5 M16x1,5 M20x1,5 M25 x1,5 M32x1,5 M40x1,5 Durchgangslöcher für Kabelverschraubungen 7 12,5 16,5 20,5 25,5 32,5 40,5 - M12x1,5 M16x1,5 M20x1,5 M25x1,5 M32x1,5 M40x1,5	05311		05314		05317	
7-40,5	3									



Gewindesortiment für Kabelverschraubungen: Seite 28
Thread Cutting Assortment for cable connections: page 28

Einsatz Stufenbohrer | Application Step Drills

	Baustahl Structural steel ≤ 500 N/mm ₂	Baustahl Structural steel > 500 N/mm ₂	Auto- matenstahl Free- cutting steel ≤ 1000 N/mm ₂	Ver- gütungs- stahl Tempered steel ≤ 1000 N/mm ₂	Legierter Stahl Alloyed steel ≤ 1200 N/mm ₂	VA Stahl VA steel ≤ 850 N/mm ₂	VA Stahl VA steel > 850 N/mm ₂	Werk- zeugstahl Tool steel ≤ 1000 N/mm ₂	Guss Cast iron ≤ 300 HB	Alu + Legierung Aluminium + alloy ≤ 450 N/mm ₂	Uni Uni	Schneidöl Cutting oil	Emulsion Emulsion	Minimal Schmie- rung Minimum lubrication	Trocken- bearbei- tung Dry machining	Pressluft Com- pressed air
	●	●	○			○				●	○	●	●		○	
	●	●	●	○		○				●	○	●	●			
	●	●	●	●	●	●	●	●	○	○	○			○	●	○

● empfohlen | recommended ○ bedingt geeignet | partly suitable

Fräs-Stufenbohrer | Step Drill and Milling Cutter

Anwendung

Für gratfreies Bohren und Aufreiben von Blechen, Rohren und Profilen sowie Fräsen von Langlöchern und Konturen.

Für Baustahl, CrNi-Stahl, NE-Metall, Karosserieblech, Acryl-Glas, Kunststoff und Holz bis max. 10 mm Stärke

Application

For drilling and roughening of sheet material, pipes and profiles and milling of elongated holes and contours.

For structural steel, CrNi-steel, non-ferrous metal, motor bodywork, acrylic glass, plastic and wood up to max. 10 mm thick.

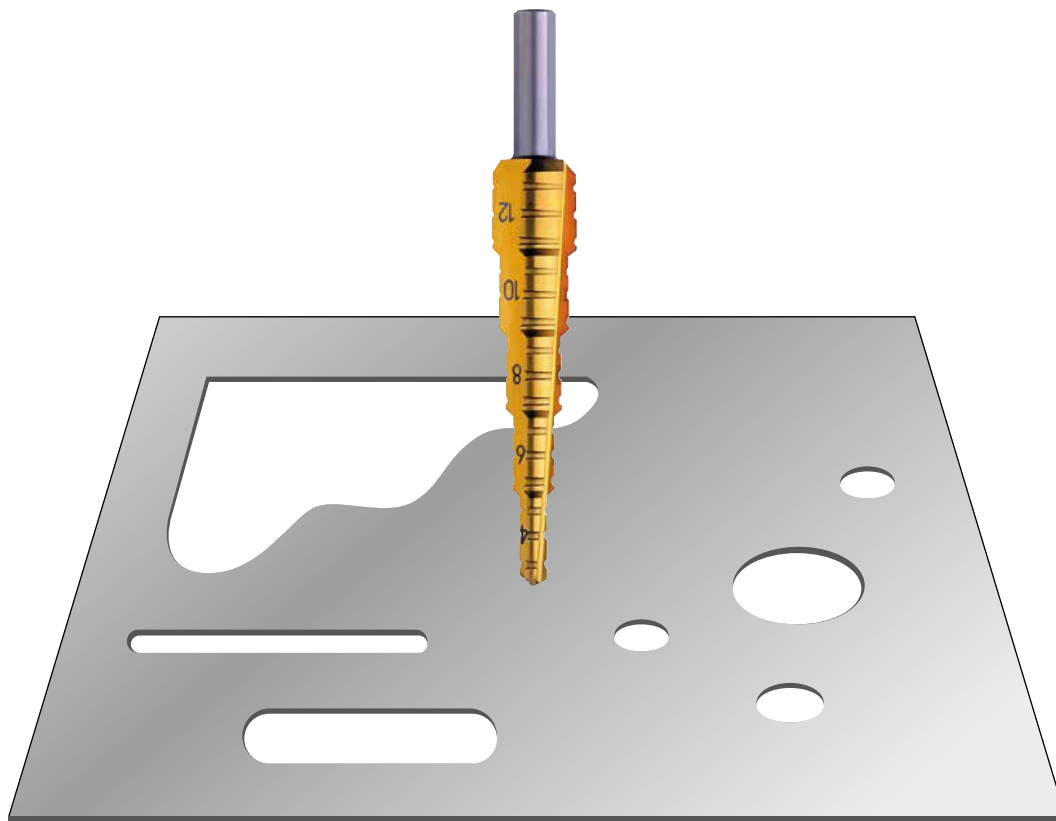

Drehzahlrichtwerte | Speeds

Drehzahlrichtwerte Speeds	Bohren Drilling	Fräsen Milling
Baustahl Structural steel	1500 - 700 n = U/min	3000 - 2000 n = U/min
CrNi-Stahl CrNi-steel	1000 - 500 n = U/min	3000 - 2000 n = U/min
NE-Metall NE-metal	2000 - 1000 n = U/min	3000 - 2000 n = U/min
Kunststoff plastic	2000 - 1000 n = U/min	3000 - 2000 n = U/min

Schneidöl-Spray & Bohrpaste siehe Seite 98 | Cutting spray & drilling paste, see page 98

Fräs-Stufenbohrer Step Drill and Milling Cutter

HSS | HSS



Technische Information
HSS = Hochleistungsschnell-Stahl

Technical Information
HSS = High-speed-steel

TIN	Zusätzliche Oberflächenhärtung:	Additional surface hardness:
	<ul style="list-style-type: none"> • Oberflächenhärte ca. 2.500 HV • Schichtstärke bis 2 µm • Für harte Materialien • Erhöhte Standzeiten • Höhere Schnittgeschwindigkeit • Temperaturbeständig bis 600° C • Reduziert Kaltaufschweißung 	<ul style="list-style-type: none"> • Surface treatment approx 2.500 HV • Layer Thickness up to 2 µm • For hard materials • Higher tool life • Higher cutting speeds • Temperature resistant up to 600° C • Reduces cold weldings
TiAIN	<ul style="list-style-type: none"> • Oberflächenhärte ca. 3.500 HV • Schichtstärke bis 4 µm • Für besonders harte Materialien • Optimale Standzeiten • Höchste Schnittgeschwindigkeit • Temperaturbeständig bis 800° C, kein Kühlmittel notwendig • Reduziert Kaltaufschweißung 	<ul style="list-style-type: none"> • Surface treatment approx 3.500 HV • Layer Thickness up to 4 µm • For hardest materials • Optimized tool life • Highest cutting speeds • Temperature resistant up to 800° C, cooling not necessary • Reduces cold weldings

Qualitätsmerkmale Quality signs	
	Made in Germany
	Laserskalierung der Loch-Ø + Drehzahlangaben Hole- and speed-Ø is laser edged on the tool
	Kreuzanschliff Split Point

Anwendung
Für gratfreies Bohren und Aufreiben von Blechen, Rohren und Profilen sowie Fräsen von Langlöchern und Konturen.

Application
For drilling of sheet material, pipes and profiles and milling of elongated holes and contours.

Mit 3-Flächenschaft | With 3-flates shaft

	10	80	6	4-6-8-10-12	05376		05377		05378	

Einsatz Stufenbohrer | Application Step Drills

	Baustahl Structural steel ≤ 500 N/mm ²	Baustahl Structural steel > 500 N/mm ²	Auto- materialenstahl Free- cutting steel ≤ 1000 N/mm ²	Ver- gütungs- stahl Tempered steel ≤ 1000 N/mm ²	Legierter Stahl Alloyed steel ≤ 1200 N/mm ²	VA Stahl VA steel ≤ 850 N/mm ²	VA Stahl VA steel > 850 N/mm ²	Werk- zeugstahl Tool steel ≤ 1000 N/mm ²	Guss Cast iron ≤ 300 HB	Alu + Legierung Aluminium + alloy ≤ 450 N/mm ²	Uni Uni	Schneidöl Cutting oil	Emulsion Emulsion	Minimal Schmie- rung Minimum lubrication	Trocken- bearbei- tung Dry machining	Presluft Com- pressed air
	●	●	○			○				●	○	●	●		○	
	●	●	●	○		○				●	○	●	●			
	●	●	●	●	●	●	●	●	○	○	○			○	●	○

● empfohlen | recommended ○ bedingt geeignet | partly suitable

HSS | HSS

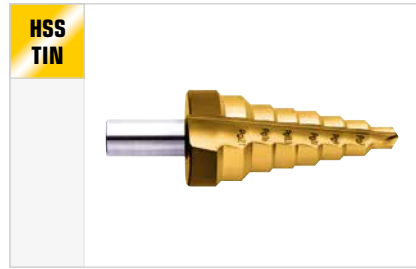

Technische Information

HSS = Hochleistungsschnell-Stahl

Technical Information

HSS = High-speed-steel

TIN

Zusätzliche Oberflächenhärtung:

- Oberflächenhärte ca. 2.500 HV
- Schichtstärke bis 2 µm
- Für harte Materialien
- Erhöhte Standzeiten
- Höhere Schnittgeschwindigkeit
- Temperaturbeständig bis 600° C
- Reduziert Kaltaufschweißung

Additional surface hardness:

- Surface treatment approx. 2.500 HV
- Layer Thickness up to 2 µm
- For hard materials
- Higher tool life
- Higher cutting speeds
- Temperature resistant up to 600° C
- Reduces cold weldings

TiAIN

- Oberflächenhärte ca. 3.500 HV
- Schichtstärke bis 4 µm
- Für besonders harte Materialien
- Optimale Standzeiten
- Höchste Schnittgeschwindigkeit
- Temperaturbeständig bis 800° C, kein Kühlmittel notwendig
- Reduziert Kaltaufschweißung

Additional surface hardness:

- Surface treatment approx. 3.500 HV
- Layer Thickness up to 4 µm
- For hardest materials
- Optimized tool life
- Highest cutting speeds
- Temperature resistant up to 800° C, cooling not necessary
- Reduces cold weldings

Qualitätsmerkmale Quality characteristics

Made in Germany

Laserskalierung der Loch-Ø + Drehzahlangaben
Hole- and speed-diameter laser engraved on the tool

Kreuzanschliff
Split Point

Anwendung

Für gratfreies Bohren und Aufreiben von Blechen, Rohren und Profilen speziell in der Elektroindustrie (Schaltschrankbau).

Bohren und Entgraten in einem Arbeitsgang.

Für Material bis 6 mm Stärke: Baustahl, CrNi-Stahl, NE-Metall.

Application

For drilling and reaming freely of burs of sheet steel, thin-walled tubes and structural steel shapes in the electrical industry. (construction of switchgear cabinets)

Drilling and deburring in one working step.

Up to 6mm material thickness: structural steel, CrNi-steel, non-ferrous metal.

No.					CODE	€	CODE	€	CODE	€
Gewindekernlöcher für Panzerrohrverschraubungen										
E 1	6	92	12	11,4 14 17,25 19 21,25 26,75	05301		15301		25301	
				Pg 7 Pg 9 Pg 11 Pg 13,5 Pg 16 Pg 21						
Durchgangslöcher für Panzerrohrverschraubungen										
E 2	4	85	12	12,5 15,2 18,6 20,4 22,5 28,3 30,5	05302		15302		25302	
				Pg 7 Pg 9 Pg 11 Pg 13,5 Pg 16 Pg 21 -						
Durchgangslöcher für Panzerrohrverschraubungen										
E 3	4	92	12	12,5 15,2 18,6 20,4 22,5 28,3 33 37	05303		15303		25303	
				Pg 7 Pg 9 Pg 11 Pg 13,5 Pg 16 Pg 21 - Pg 29						

Schneidöl-Spray & Bohrpaste siehe Seite 98 | Cutting spray & drilling paste, see page 98

Stufenbohrer für Leitplanken Step Drills for guardrail systems

EXACT
PRÄZISIONSWERKZEUGE

HSS | HSS



Mit 3-Flächenschaft | With 3-flates shaft

67	6 - 18	07042	

Vorteile | Advantages

	<p>Spezialabmessungen 6 - 18 mm</p> <ul style="list-style-type: none"> • Speziell für Bohrungen von Leitplanken konzipiert! • Effizientes + schnelleres Arbeiten 	<p>Special dimensions 6 - 18 mm</p> <ul style="list-style-type: none"> • Specially designed for guardrail systems! • Faster and more efficient working
	<p>Spezialkonus im zylindrischen Bereich (im Gegensatz zu Standardbohrern)</p> <ul style="list-style-type: none"> • Kein Verkanten des Werkzeugs während des Bohrens => keine Hand-/Gelenkverletzungen, keine Arbeitsausfälle! • Kein Verklemmen beim Werkzeugausführen aus dem Bohrloch! • Deutliche Reduzierung von Arbeitsunfällen – sicheres Arbeiten 	<p>Conical design especially for cylindrical applications, unlike mid-range</p> <ul style="list-style-type: none"> • No tilting of the tool during drill process => No wrist joint injuries and no lost-time accidents • No wedging when back out of the drillhole! • Significant reduction in work accidents – secured working
	<p>Verlängerte Bohrstufen 12 mm + 18 mm</p> <ul style="list-style-type: none"> • Bessere Kontrolle bei der Durchführung von 12 + 18 mm Bohrungen an Leitplankenpfosten (12 mm zur Montage von Holmen & Distanzstücken + 18 mm für Leitplankenholme & Kastenprofile) • Verlängerte Bohrstufe 12 mm minimiert die Gefahr von unbeabsichtigten Bohrerweiterungen • Verlängerte Bohrstufe 18 mm ermöglicht Doppelbohrung: 2 Leitplanken in 1 Arbeitsgang 	<p>Drilling step prolonged, 12mm and 18mm</p> <ul style="list-style-type: none"> • Better control when drilling 12 + 18 mm holes in guardrail posts (12 mm to attach struts and spacers, + 18 mm for guardrail struts and box sections) • Longer 12 mm step minimizes the danger of unintended hole widening • Longer 18 mm step makes double-drilling easier, for 2 guardrails in 1 work step
	<p>Integrierter Bohrfutterschutz</p> <ul style="list-style-type: none"> • Durch integrierten Anschlagring – entwickelt zum Schutz des Bohrfutters bei kraftintensivem Arbeiten • Erhebliche Kostenreduzierung 	<p>Integrated protection of the drill chuck</p> <ul style="list-style-type: none"> • Caused by the integrated stop-ring – developed to protect the drill chuck at powerful working • Considerable cost reduction
	<p>Für vollverzinkte Materialien</p> <ul style="list-style-type: none"> • Einsatz bis 3,5 mm Tiefe / Stärke • Erweiterter Einsatzbereich 	<p>For fully galvanized materials</p> <ul style="list-style-type: none"> • Usable up to 3.5mm material thickness • Wider range of application
	<p>Variable Spiralnute</p> <ul style="list-style-type: none"> • Optimales Schneidverhalten durch konstante Schnittwinkel • Beste Bohreigenschaften 	<p>Variable spiral flute</p> <ul style="list-style-type: none"> • Optimal cutting behaviour caused by the constant cutting angle • Best drill conditions
	<p>TiCN-Beschichtung</p> <ul style="list-style-type: none"> • Verwendung von Bohrrölen möglich • Optimale Schneidresultate bei vollverzinkten Materialien • Reduzierung von Kaltaufschweißungen 	<p>TiCN coating</p> <ul style="list-style-type: none"> • Allowed the use of drilling oils • Optimum results when using fully galvanized materials • Reduction of cold bonding

Stufenbohrer-Bit Step Drill Bit

HSS | HSS

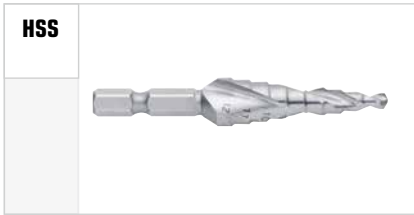

Technische Information

HSS = Hochleistungsschnell-Stahl

Technical Information

HSS = High-speed-steel

TIN

Zusätzliche Oberflächenhärtung:

- Oberflächenhärte ca. 2.500 HV
- Schichtstärke bis 2 µm
- Für harte Materialien
- Erhöhte Standzeiten
- Höhere Schnittgeschwindigkeit
- Temperaturbeständig bis 600° C
- Reduziert Kaltaufschweißung

Additional surface hardness:

- Surface treatment approx. 2.500 HV
- Layer Thickness up to 2 µm
- For hard materials
- Higher tool life
- Higher cutting speeds
- Temperature resistant up to 600° C
- Reduces cold weldings

TiAIN

- Oberflächenhärte ca. 3.500 HV
- Schichtstärke bis 4 µm
- Für besonders harte Materialien
- Optimale Standzeiten
- Höchste Schnittgeschwindigkeit
- Temperaturbeständig bis 800° C, kein Kühlmittel notwendig
- Reduziert Kaltaufschweißung

- Surface treatment approx. 3.500 HV
- Layer Thickness up to 4 µm
- For hardest materials
- Optimized tool life
- Highest cutting speeds
- Temperature resistant up to 800° C, cooling not necessary
- Reduces cold weldings

Qualitätsmerkmale Quality characteristics



Made in Germany



Laserskalierung der Loch-Ø + Drehzahlangaben
Hole- and speed-diameter laser engraved on the tool



Kreuzanschliff
Split Point

Anwendung

Für gratfreies Bohren von Blechen, Rohren und Profilen.

Application

For drilling and reaming freely of burrs of sheet steel, thin-walled tubes and structural steel shapes.

1/4" Bit-Schaft | 1/4" Bit-shaft

mm	mm	mm	mm	mm	CODE	€	CODE	€	CODE	€
27	5	72	6,35	4 - 12	08001		08011		08021	
27	4	81	6,35	4 - 20	08002		08012		08022	
27	4	105	6,35	4 - 30	08003		08013		08023	

Einsatz Stufenbohrer-Bit | Application Step Drill Bit

	Baustahl Structural steel ≤ 500 N/mm ₂	Baustahl Structural steel > 500 N/mm ₂	Auto- matenstahl Free- cutting steel ≤ 1000 N/mm ₂	Ver- gütungs- stahl Tempered steel ≤ 1000 N/mm ₂	Legierter Stahl Alloyed steel ≤ 1200 N/mm ₂	VA Stahl VA steel ≤ 850 N/mm ₂	VA Stahl VA steel > 850 N/mm ₂	Werk- zeugstahl Tool steel ≤ 1000 N/mm ₂	Guss Cast iron ≤ 300 HB	Alu + Legierung Aluminium + alloy ≤ 450 N/mm ₂	Uni Uni	Schneidöl Cutting oil	Emulsion	Minimal Schmie- rung Minimum lubrication	Trocken- bearbei- tung Dry machining	Pressluft Com- pressed air
	●	●	○			○				●	○	●	●		○	
	●	●	●	○		○				●	○	●	●			
	●	●	●	●	●	●	●	●	○	○	○			○	●	○

● empfohlen | recommended ○ bedingt geeignet | partly suitable







Stufenbohrer-Bit Step Drill Bit

Sets HSS | Sets HSS

HSS



1/4" Bit-Schaft | 1/4" Bit-shaft

			
4-12 / 4-20 / 4-30		08004	

Stufenbohrer • Step Drills

HSS
TIN



1/4" Bit-Schaft | 1/4" Bit-shaft

			
4-12 / 4-20 / 4-30		08014	

HSS
TIN



1/4" Bit-Schaft | 1/4" Bit-shaft

			
4-12 / 4-20 / 4-30		08024	

Produktinformation | Product information

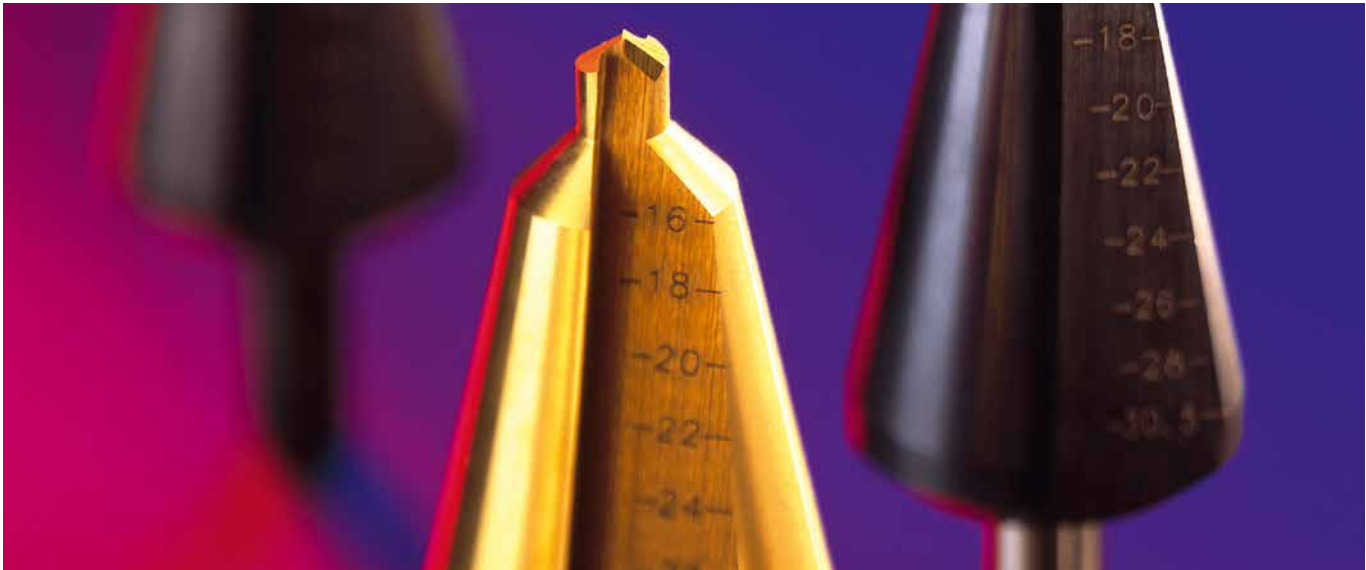

Qualitätsmerkmale | Quality characteristics

VAP	Zusätzliche Oberflächenhärtung:	Additional surface hardness:	Made in Germany	
TIN	<ul style="list-style-type: none"> Verbesserte Standzeiten Minderung von Aufbauschneiden Oberflächenhärtete ca. 2.500 HV Schichtstärke bis 2 µm Für harte Materialien Erhöhte Standzeiten Höhere Schnittgeschwindigkeit Temperaturbeständig bis 600° C Reduziert Kaltaufschweißung 	<ul style="list-style-type: none"> Longer tool-life Less cold-welding Surface treatment approx. 2.500 HV Layer Thickness up to 2 µm For hard materials Higher tool life Higher cutting speeds Temperature resistant up to 600° C Reduces cold weldings 		HSS-E
TiAlN	<ul style="list-style-type: none"> Oberflächenhärtete ca. 3.500 HV Schichtstärke bis 4 µm Für besonders harte Materialien Optimale Standzeiten Höchste Schnittgeschwindigkeit Temperaturbeständig bis 800° C, kein Kühlmittel notwendig Reduziert Kaltaufschweißung 	<ul style="list-style-type: none"> Surface treatment approx. 3.500 HV Layer Thickness up to 4 µm For hardest materials Optimized tool life Highest cutting speeds Temperature resistant up to 800° C, cooling not necessary Reduces cold weldings 		Laserskalierung der Loch-Ø + Drehzahlangaben Hole- and speed-diameter laser engraved on the tool
			Kreuzanschliff Split Point	

Einsatz Blechsälbohrer | Application Tube & Sheet Drills

	Baustahl Structural steel ≤ 500 N/mm ²	Baustahl Structural steel > 500 N/mm ²	Auto- matenstahl Free- cutting steel ≤ 1000 N/mm ²	Ver- gütungs- stahl Tempered steel ≤ 1000 N/mm ²	Legierter Stahl Alloyed steel ≤ 1200 N/mm ²	VA Stahl VA steel ≤ 850 N/mm ²	VA Stahl VA steel > 850 N/mm ²	Werk- zeugstahl Tool steel ≤ 1000 N/mm ²	Guss Cast iron ≤ 300 HB	Alu + Legierung Aluminium + alloy ≤ 450 N/mm ²	Uni Uni	Schneidöl Cutting oil	Emulsion Emulsion	Minimal Schmie- rung Minimum lubrication	Trocken- bearbei- tung Dry machining	Pressluft Com- pressed air
	●	●	○							●		●	●			
	●	●	●			○				●	○	●	●			
	●	●	●	●		●	●	●	○	○	○			○	●	

● empfohlen | recommended ○ bedingt geeignet | partly suitable

Blechsälbohrer • Tube & Sheet Drills

HSS | HSS



Technische Information

HSS = Hochleistungsschnell-Stahl
HSS VAP = Hochleistungsschnell-Stahl vaporisiert

Technical Information

HSS = High-speed-steel
HSS VAP = High-speed-steel vaporized

Anwendung

Für gratfreies Bohren und Aufreiben von Blechen, Rohren und Profilen

Application

For drilling and reaming freely of burs of sheet steel, thin-walled tubes and structural steel shapes.

HSS	mm	mm	mm	CODE HSS	€	CODE HSS	€	CODE HSS	€
Gr. 1	3,0 - 14,0	58	6	05201		50101		50111	
Gr. 2	4,0 - 20,0	71	8	05202		50102		50112	
Gr. 3	16,0 - 30,5	76	9	05203		50103		50113	
Gr. 4	24,0 - 40,0	89	10	05204		50106		50114	
Gr. 5	36,0 - 50,0	97	12	05205		50107		50115	
Gr. 6	40,0 - 61,0	103	12	05206		50108		50116	
Gr. L	4,0 - 31,0	103	9	05207		50104		50117	
Gr. A	4,0 - 22,5	79	8	05208		50099		50121	
Gr. 7	5,0 - 25,4	87	10	05210		50100		50120	

HSS-E • Hochleistungsschnell-Stahl | HSS-E • High-speed-steel



Technische Information

HSS-E = Hochleistungsschnell-Stahl Klasse E
HSS-E VAP = Hochleistungsschnell-Stahl Klasse E vaporisiert

Technical Information

HSS-E = High-speed-steel E-class
HSS-E VAP = High-speed-steel E-class vaporized

Anwendung

Für gratfreies Bohren und Aufreiben von Blechen, Rohren und Profilen

Application

For drilling and reaming freely of burs of sheet steel, thin-walled tubes and structural steel shapes.

HSS-E	mm	mm	mm	CODE HSS-E	€	CODE HSS-E	€	CODE HSS-E	€
Gr. 1	3,0 - 14,0	58	6	05221		05241		05271	
Gr. 2	4,0 - 20,0	71	8	05222		05242		05272	
Gr. 3	16,0 - 30,5	76	9	05223		05243		05273	
Gr. 4	24,0 - 40,0	89	10	05224		05244		50151	
Gr. 5	36,0 - 50,0	97	12	05225		05245		50152	
Gr. 6	40,0 - 61,0	103	12	05226		05246		50153	
Gr. L	4,0 - 31,0	103	9	05227		05247		05274	



Blechsälbohrer Tube & Sheet Drills

EXACT
PRÄZISIONSWERKZEUGE

Blechsälbohrer • Tube & Sheet Drills

Sets HSS + HSS-E | Sets HSS + HSS-E

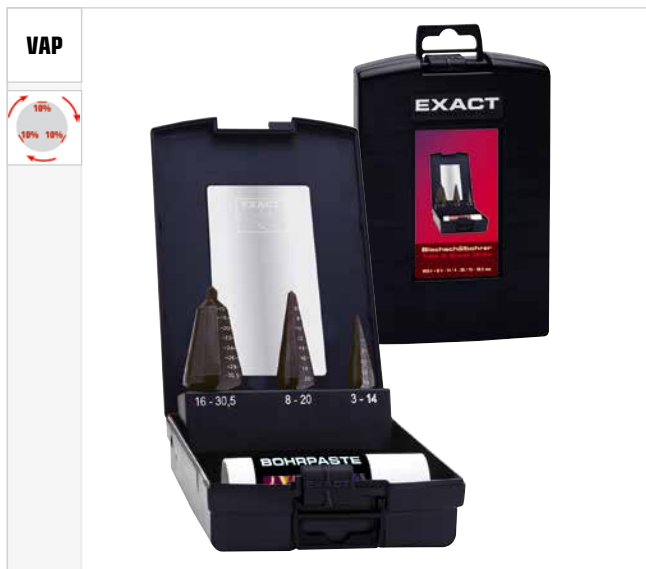

HSS	INHALT	CODE	€ SET
	3-14 / 4-20 / 16-30,5 + Bohrpaste	05209	

HSS-E	INHALT	CODE	€ SET
	3-14 / 4-20 / 16-30,5 + Bohrpaste	05228	



HSS	INHALT	CODE	€ SET
	3-14 / 4-20 / 16-30,5 + Bohrpaste	50105	

HSS-E	INHALT	CODE	€ SET
	3-14 / 4-20 / 16-30,5 + Bohrpaste	05248	

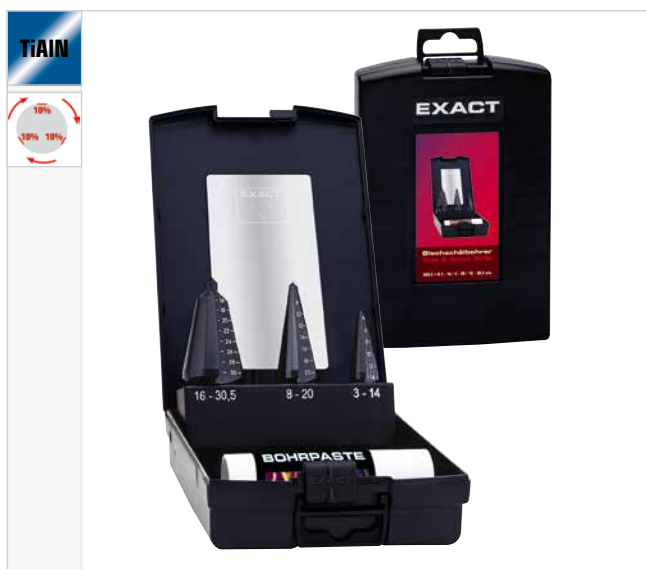

HSS	INHALT	CODE	€ SET
	3-14 / 4-20 / 16-30,5 + Bohrpaste	50118	

HSS-E	INHALT	CODE	€ SET
	3-14 / 4-20 / 16-30,5 + Bohrpaste	05275	

**Schneidöl-Spray & Bohrpaste siehe Seite 98
Cutting spray & drilling paste, see page 98**

INNOVATION BY

EXACT
PRÄZISIONSWERKZEUGE

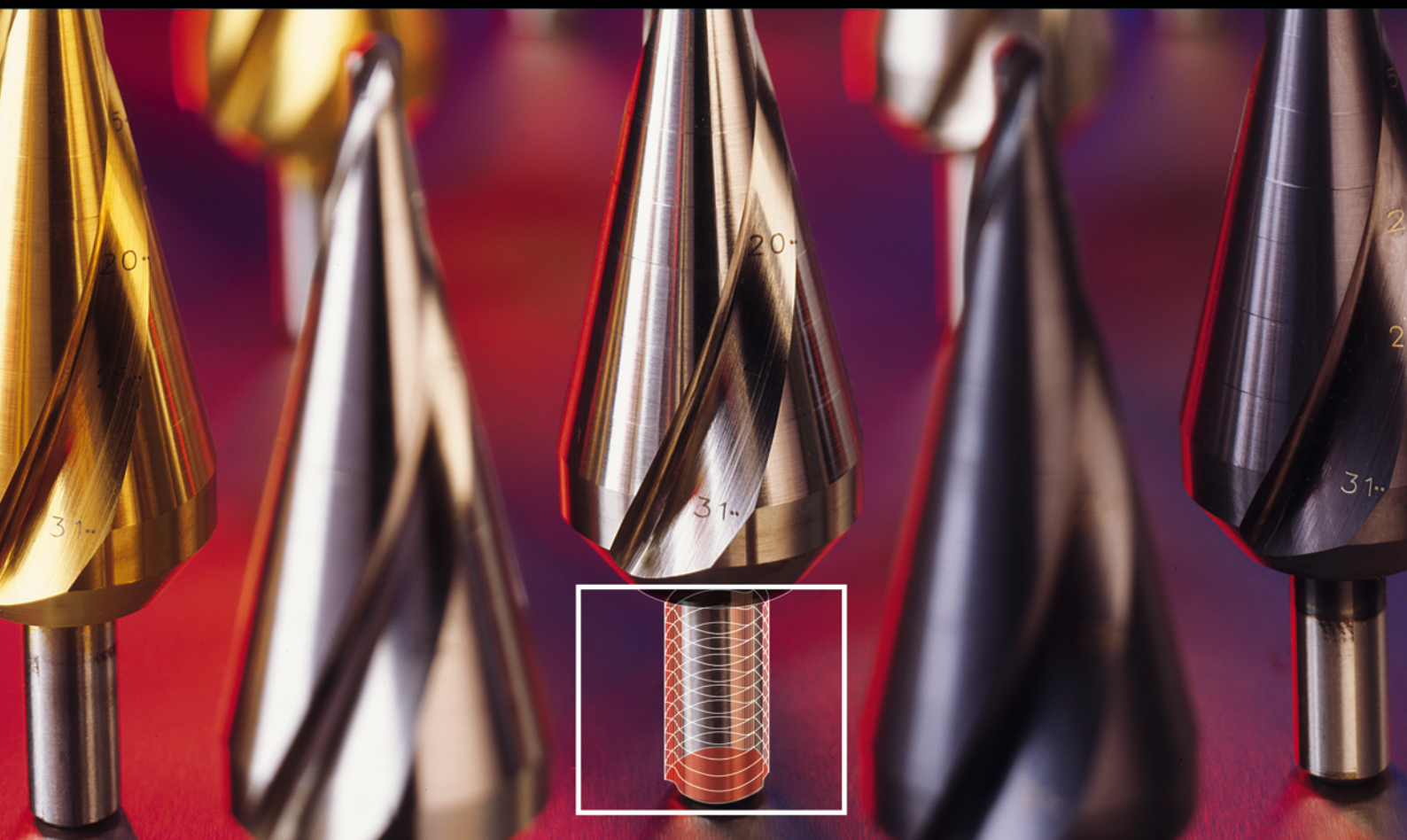

ROTASTOP®-SCHAFT

INNOVATION | INNOVATION



Durch ansteigende Formen spannt sich ROTASTOP® selbst im Bohrfutter
ROTASTOP® chucks itself automatically by rising contours

- Alle EXACT Stufenbohrer und Blechschälbohrer mit Spiralnute verfügen über ROTASTOP®-Schäfte
- All EXACT Step-, Tube & Sheet Drills with spiral flute

VORTEILE | ADVANTAGES

- Kein Durchrutschen im Bohrfutter
- ROTASTOP® spannt sich selbst im Bohrfutter
- Optimale Drehmomentübertragung
- Präzise Ergebnisse
- Einfacher Werkzeugwechsel

- **No slipping in the chuck**
- **ROTASTOP® chucks itself automatically**
- **Optimum transmission of the torque**
- **Precise results**
- **Easy tool changing**

Blechsälbohrer mit Spiralnute Tube & Sheet Drills with spiral flute

Qualitätsmerkmale | Quality characteristics



TIN

Zusätzliche Oberflächenhärtung:

- Oberflächenhärte ca. 2.500 HV
- Schichtstärke bis 2 µm
- Für harte Materialien
- Erhöhte Standzeiten
- Höhere Schnittgeschwindigkeit
- Temperaturbeständig bis 600° C
- Reduziert Kaltaufschweißung

Additional surface hardness:

- Surface treatment approx. 2.500 HV
- Layer Thickness up to 2 µm
- For hard materials
- Higher tool life
- Higher cutting speeds
- Temperature resistant up to 600° C
- Reduces cold weldings



Made in Germany

EXACT Innovation



ROTASTOP® Komfortschaft
ROTASTOP® convenience shaft (S. 183)



Mit Spiralnute | Spiral flute



Laserskalierung der Loch-Ø + Drehzahlangaben
Hole- and speed-diameter laser engraved on the tool



Kreuzanschliff
Split Point

TiAlN

- Oberflächenhärte ca. 3.500 HV
- Schichtstärke bis 4 µm
- Für besonders harte Materialien
- Optimale Standzeiten
- Höchste Schnittgeschwindigkeit
- Temperaturbeständig bis 800° C, kein Kühlmittel notwendig
- Reduziert Kaltaufschweißung

- Surface treatment approx. 3.500 HV
- Layer Thickness up to 4 µm
- For hardest materials
- Optimized tool life
- Highest cutting speeds
- Temperature resistant up to 800° C, cooling not necessary
- Reduces cold weldings

Anwendung | Application

Für gratfreies Bohren und Aufreiben von Blechen, Rohren und Profilen.
For drilling and reaming freely of burs of sheet steel, thin-walled tubes and structural steel shapes.

Einsatz Blechsälbohrer | Application Tube & Sheet Drills

	Baustahl Structural steel ≤ 500 N/mm ₂	Baustahl Structural steel > 500 N/mm ₂	Auto- matenstahl Free- cutting steel ≤ 1000 N/mm ₂	Ver- gütungs- stahl Tempered steel ≤ 1000 N/mm ₂	Legierter Stahl Alloyed steel ≤ 1200 N/mm ₂	VA Stahl VA steel ≤ 850 N/mm ₂	VA Stahl VA steel > 850 N/mm ₂	Werk- zeugstahl Tool steel ≤ 1000 N/mm ₂	Guss Cast iron ≤ 300 HB	Alu + Legierung Aluminium + alloy ≤ 450 N/mm ₂	Uni Uni	Schneidöl Cutting oil	Emulsion Emulsion	Minimal Schmie- rung Minimum lubrication	Trocken- bearbei- tung Dry machining	Pressluft Com- pressed air
	●	●	○							●		●	●			
	●	●	●			○				●	○	●	●			
	●	●	●	●		●	●	●	○	○	○			○	●	

● empfohlen | recommended ○ bedingt geeignet | partly suitable



Blechsälbohrer mit Spiralnute

Tube & Sheet Drills with spiral flute

HSS | HSS

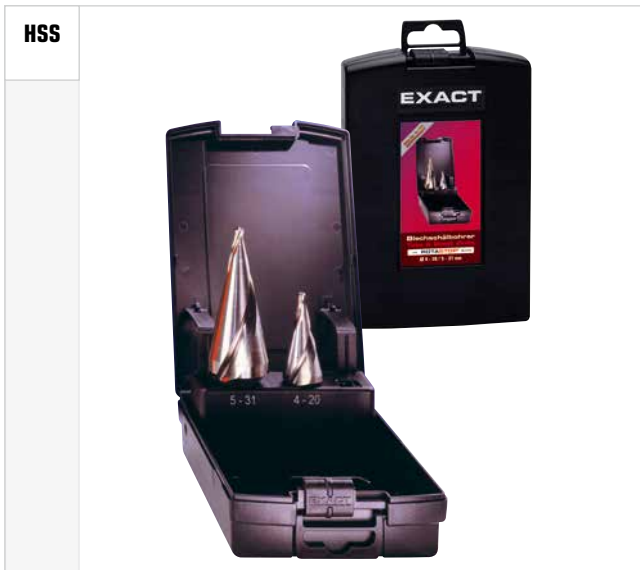

ROTASTOP®-Schaft | -shaft

ROTASTOP	INHALT	CODE	€ SET
	5-20	05279	
	5-31	05280	
	5-20 / 5-31	05281	

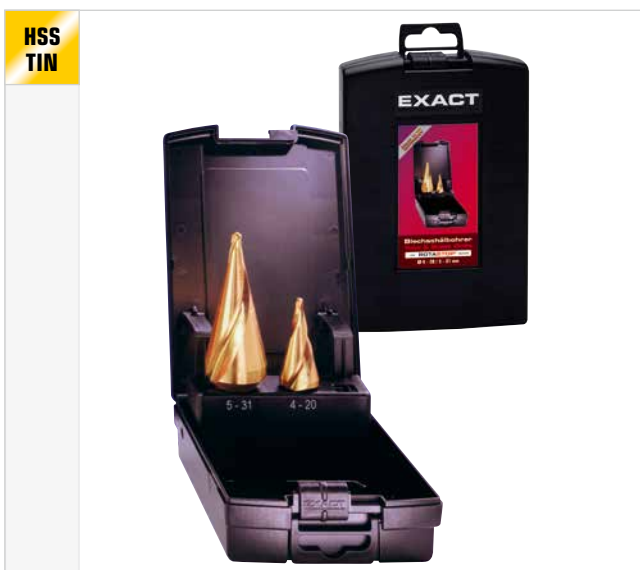

ROTASTOP®-Schaft | -shaft

ROTASTOP	INHALT	CODE	€ SET
	5-20	05282	
	5-31	05283	
	5-20 / 5-31	05284	



ROTASTOP®-Schaft | -shaft

ROTASTOP	INHALT	CODE	€ SET
	5-20	05285	
	5-31	05286	
	5-20 / 5-31	05287	

Blechsälbohrer • Tube & Sheet Drills

EXACT
Innovation

EXACT
COATING TECHNOLOGIE



TITAN PRO

Beschichtung | Coating

BESCHREIBUNG

Diese Neuentwicklung ist eine TIALN / TIN Kombinationsschicht und verfügt über ein sehr gutes Verschleißverhalten, sowie gute thermische Stabilität. TITAN-PRO Beschichtungen sind universell einsetzbar und für die Bearbeitung von hochfesten Materialien geeignet.

DESCRIPTION

This new development is a combination of TIALN and TIN coating. It combines excellent wear resistance with good thermal stability. TITAN-PRO coating can be used universally and its suitable for high-strength materials.

TECHNISCHE INFORMATION

Beschichtungsmaterial: TIALN / TIN
Schichtfarbe: Violett
Schichtstruktur: Multilayer
Schichtstärke: bis 2 µm
Oberflächenhärte: ca. 3100 HV
Anwendungstemperatur: bis 650 °C

TECHNICAL INFORMATION

Coating: TIALN / TIN
Layer colour: Violet
Layer: multilayer
Layer thickness: up to 2 µm
Surface hardness: ca. 3100 HV
Temperature: up to 650 °C

VORTEILE

- **Optimale Standzeiten**
- **Geringer Reibungskoeffizient**
- **Höhere Schnittgeschwindigkeit**
- **Prozesskostenoptimierung**
- **Ca. 25 % mehr Leistung**

ADVANTAGES

- **Optimum service life**
- **A low coefficient of friction**
- **Higher cutting speed**
- **Process cost optimisation**
- **Appr. 25% higher performance**

Blechsälbohrer mit Spiralnute | Tube & Sheet Drills with spiral flute



ROTASTOP®-Schaft | -shaft

	 
5-20	09002

ROTASTOP®-Schaft | -shaft

	 
5-31	09003





Anwendung | Application

Für gratfreies Bohren und Aufreiben von Blechen, Röhren und Profilen.
For drilling and reaming freely of burrs of sheet steel, thin-walled tubes and structural steel shapes.

Set | Set



ROTASTOP®-Schaft | -shaft

	  
5-20 / 5-31	09004



SENKER COUNTERSINKS

EXACT®

ADVANCEDLINE® Hochleistungssenker

ADVANCEDLINE® High Performance Countersinks

- Qualitätsmerkmale und Vorteile **190-191**
- HSS **192-193**

Kegelsenker 90°

Countersinks 90°

- Qualitätsmerkmale, Materialbearbeitung, Beschichtung **194-195**
- HSS **196-197**
- HSS lange Ausführung **202**
- HSS extra lange Ausführung **203**
- HSS mit Morsekegelschaft **204**
- HSS-E **198**
- HM **199**
- PM **199**
- TITAN PRO-Beschichtung HSS **200-201**

Handentgrater 90°

Hand Deburring Tool 90°

- HSS **205**

Kegelsenker 60° und 75°

Countersinks 60° und 75°

- HSS **206**

Kegelsenker 120°

Countersinks 120°

- HSS **207**

Querloachsenker 90°

Deburring Countersinks 90°

- HSS **208**
- HSS-E **209**

Flachsenker

Counterbores

- HSS für Kernloch **210**
- HSS für Durchgangsloch fein **211**
- HSS für Durchgangsloch mittel **212**
- HSS mit Morsekegelschaft **213**



TEST THE BEST
ADVANCEDLINE®
THE COUNTERSINK INNOVATION

NEUE SCHNEIDGEOMETRIE

Harmonische Teilung verhindert ungleiche Abnutzung der Schneidkanten

NEU

OPTIMIERTES SCHLEIFVERFAHREN

Extrem hohe Rundlaufgenauigkeit bei merklich reduzierten Kraftaufwand

PATENTIERTER ROTASTOP®-SCHAFT

100% Sicherung gegen Durchdrehen des Senkers im Bohrfutter bei optimaler Drehmomentübertragung





MEHR LEISTUNG

Extrem hohe Verschleißfestigkeit und Wärmehärte garantiert maximale Standzeiten



Qualitätsmerkmale | Quality signs

Merkmale / Feature	Vorteile / Advantages	Nutzen / Benefit
 <p>Optimiertes Schleifverfahren Optimized grinding process</p>	<ul style="list-style-type: none"> • Sehr gute Spanbildung • Geringerer Verschleiß, da reduzierter Kraftaufwand • Very good chip formation • Highest rotation accuracy and reduced effort 	<p>bis zu / up to +25 % schnelleres Senken, als mit herkömmlichen Senkern faster countersinking than with conventional countersinks</p>
 <p>Neue Schneidgeometrie New cutting flute geometry</p>	<ul style="list-style-type: none"> • Deutlich bessere Schneideigenschaften • Deutlich größere Freiwinkel • Höchste Verschleißfestigkeit • Far superior cutting characteristics • Much greater angle of clearance • Highest wear resistance 	<p>bis zu / up to +50 % höhere Standzeiten longer service life</p>
 <p>Patentierter ROTASTOP®-Schaft Patented ROTASTOP®-Shaft</p>	<ul style="list-style-type: none"> • Beste Drehmomentübertragung • Kein Durchrutschen im Bohrfutter • Best torque transmission • No slippage in the drill chuck 	<p>100 % Sicherung gegen Durchdrehen protection against slipping in the chuck</p>

Kegelsenker 90° | Countersinks 90°

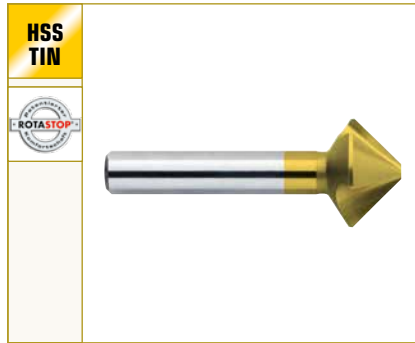
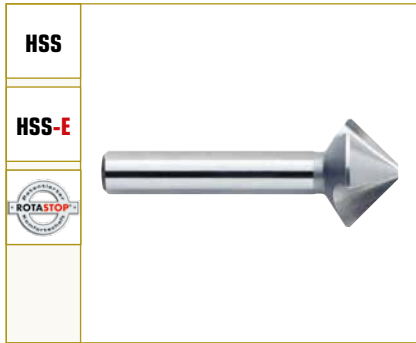

Technische Information

HSS = Hochleistungsschnell-Stahl
Mit patentierten **ROTA STOP**®-Schaft

Technical Information

HSS = High-speed-steel
With patented **ROTA STOP**®-Shaft



Vorteile | Advantages

- +** bis zu **25%** schnelleres Senken

+ bis zu **50%** höhere Standzeiten

+ extrem ruhiger Lauf

+ kein Durchrutschen im Bohrfutter

+ optimales Senkbild
- +** up to **25%** faster cutting process

+ up to **50%** longer service life

+ extremely smooth operation

+ no slipping in the chuck

+ extremely smooth surface

mm	mm	mm	mm	DIN 74 BF	CODE HSS	€	CODE HSS	€	CODE HSS	€	CODE HSS-E	€
6,3	45	5	1,5	M 3	50201		50221		50241		50260	
8,3	50	6	2,0	M 4	50202		50222		50242		50261	
10,4	50	6	2,5	M 5	50203		50223		50243		50262	
12,4	56	8	2,8	M 6	50204		50224		50244		50263	
15,0	60	10	3,2	M 8	50205		50225		50245		50264	
16,5	60	10	3,2	M 8	50206		50226		50246		50265	
19,0	63	10	3,5	M 10	50207		50227		50247		50266	
20,5	63	10	3,5	M 10	50208		50228		50248		50267	
23,0	67	10	3,8	M 12	50209		50229		50249		50268	
25,0	67	10	3,8	M 12	50210		50230		50250		50269	
31,0	71	12	4,2	M 16	50211		50231		50251		50270	

HSS	Einsatz Kegelsenker 90° Application Countersinks 90°															
	Baustahl	Baustahl	Auto- matenstahl Free- cutting steel	Ver- gütungs- stahl Tempered steel	Legierter Stahl Alloyed steel	Stahl gehärtet Hardened steel	VA Stahl	VA Stahl	Werk- zeugstahl Tool steel	Guss Cast iron	Kupfer Copper	Alu + Legierung Aluminium + alloy	Uni Uni	Emulsion	Minimal Schmie- rung Minimum lubrication	Trocken- bearbei- tung Dry machining
	≤ 500 N/ mm ²	> 500 N/ mm ²	≤ 1000 N/ mm ²	≤ 1000 N/ mm ²	≤ 1200 N/ mm ²	40 - 60 HRC	≤ 850 N/ mm ²	> 850 N/ mm ²	≤ 1000 N/ mm ²	≤ 300 HB	≤ 400 N/ mm ²	≤ 450 N/ mm ²				
	●	●	●									●		●		
	○	●	●				○				○	●	●	●		○
	●	●	●	●	○		●	●	○						○	●

● empfohlen | recommended ○ bedingt geeignet | partly suitable

Sets Kegelsenker 90° | Sets Countersinks 90°



NEU				6,3 8,3 10,4 12,4 16,5 20,5	50212	
				6,3 10,4 16,5 20,5 25,0	50213	

NEU				6,3 8,3 10,4 12,4 16,5 20,5	50214	
				6,3 10,4 16,5 20,5 25,0	50215	



NEU				6,3 8,3 10,4 12,4 16,5 20,5	50232	
				6,3 10,4 16,5 20,5 25,0	50233	



NEU				6,3 8,3 10,4 12,4 16,5 20,5	50252	
				6,3 10,4 16,5 20,5 25,0	50253	

**Schneidöl-Spray & Bohrpaste siehe Seite 98
Cutting spray & drilling paste, see page 98**

Qualitätsmerkmale | Quality signs



100 % definierte Schneidengeometrie:

Kombinierter axial-radialer Hinterschliff, Profi-Schnittwinkel an der Schneidbrust wird nur erreicht durch unsere 5-Achsen Schleiftechnologie!

100% defined Cutting geometric:

Combined axial/radial relief, Professional-Cutting angle at the cutting edge could only be produced by our 5-Axis Grinding Technology!

Das kombinierte axial-radiale Schleifverfahren garantiert in Verbindung mit unserer CBN-Schleiftechnologie: Ratterfreies und riefenfreies Arbeiten, hohe Oberflächengüte der Senkung, optimale Standmenge / Standzeit

The combined axial – radial grinding process guarantee in Combination with our CBN grinding technology: Chatter and score free countersink, optimized tool life

Große Spankammer mit glattem Nutengrund:

Profil & Form der Spankammer garantieren einwandfreie Spanabfuhr, auch bei langspanenden Materialien

Big Grooves with smooth flute ground:

Profile & Form of the Flutes guarantees flawless Chip removal, as well at long ship material

Neues Produktionsverfahren | New production process

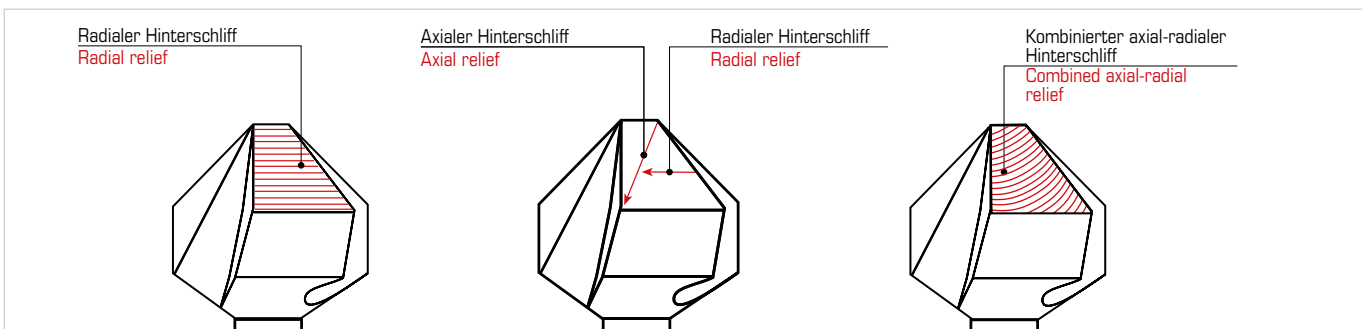

Messergebnis Symmetrie Senkschneiden | Measuring result of symetric

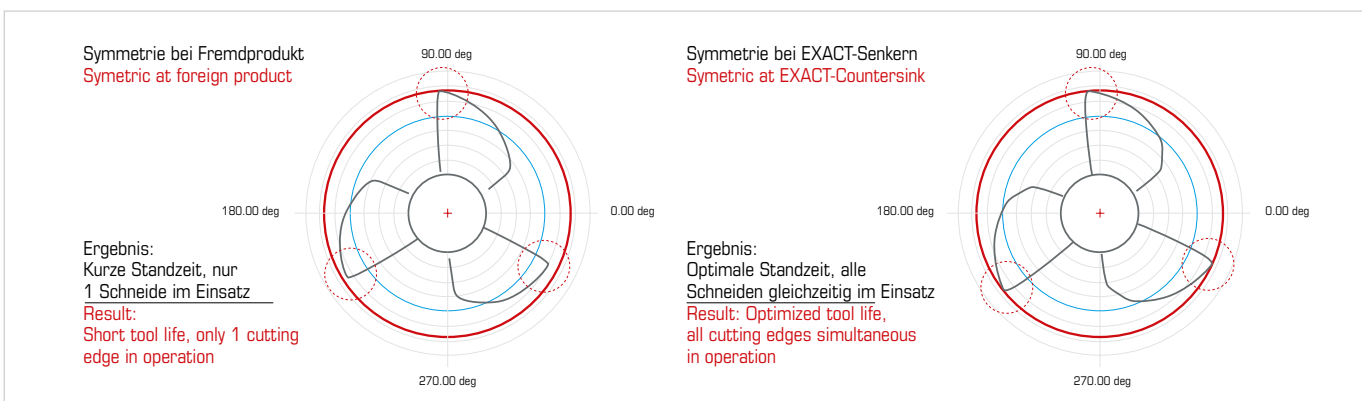





Oberflächenbehandlung | Surface treatment

TiN	Titan-Nitrid Beschichtung		Titan-Nitride Coating	
	Farbe:	Gold	Colour:	Gold
	Anwendung:	Für Baustahl, CrNi-Stahl, NE-Metalle und Kunststoffe	Application:	For steel, chrome-nickel steel, non-ferrous metal and plastic
	Schicht:	Multilayer Schichten	Layer:	Multilayer coating
	Gesamte Schichtstärke:	bis 2 µm	Layer thickness:	up to 2 µm
	Oberflächenhärte:	ca. 2.500 HV	Surface hardness:	approx 2.500 HV
	Temperaturbeständig:	bis 600° C	Temperature resistant:	up to 600° C
	Kühlung:	Nicht notwendig – wird aber empfohlen	Cooling:	Not necessary but recommended
	Vorteile:	<ul style="list-style-type: none"> • Hohe Härte • Geringer Reibungskoeffizient • Erhöhte Standzeiten • Höhere Schnittgeschwindigkeit 	Advantages:	<ul style="list-style-type: none"> • High surface hardness • Less coefficient of friction • Longer tool-life • Higher cutting speed

TiCN	Titan-Carbo-Nitrid Beschichtung		Titan-Carbo-Nitride Coating	
	Farbe:	Violett/Purple	Colour:	Violett/purple
	Anwendung:	Besonders geeignet für aufschmierende Werkstoffe wie Aluminium und VA	Application:	Good attitudes at greasy materials like Aluminium and VA (Stainless steel)
	Schicht:	Multilayer Schichten	Layer:	Multilayer coating
	Gesamte Schichtstärke:	bis 4 µm	Layer thickness:	up to 4 µm
	Oberflächenhärte:	ca. 3.000 HV	Surface hardness:	approx 3.000 HV
	Temperaturbeständig:	bis 400° C	Temperature resistant:	up to 400° C
	Kühlung:	Wird empfohlen	Cooling:	Recommended
	Vorteile:	<ul style="list-style-type: none"> • Erhöhte Standzeiten • Höhere Schnittgeschwindigkeit 	Advantages:	<ul style="list-style-type: none"> • Longer tool-life • Higher cutting speed

TiAlN	Titan-Aluminium-Nitrid Beschichtung		Titan-Aluminium-Nitride Coating	
	Farbe:	Schwarz-Violett	Colour:	Black-purple
	Anwendung:	Für hochabrasive Materialien	Application:	Perfect for stainless steel cutting
	Schicht:	Multilayer Schichten	Layer:	Multilayer coating
	Gesamte Schichtstärke:	bis 4 µm	Layer thickness:	up to 4 µm
	Oberflächenhärte:	ca. 3.500 HV	Surface hardness:	approx 3.500 HV
	Temperaturbeständig:	bis 800° C	Temperature resistant:	up to 800° C
	Kühlung:	Kein Kühlmittel!	Cooling:	Not use any!
	Vorteile:	<ul style="list-style-type: none"> • Zur Trockenzerspanung geeignet • Keramische Oberfläche minimiert Reibung • Optimale Standzeiten • Höchste Schnittgeschwindigkeit 	Advantages:	<ul style="list-style-type: none"> • Dry cutting • Ceramic surface prevented friction • Longer tool-life • Highest cutting speed

HSS	Einsatz Kegelsenker 90° Application Countersinks 90°															
	Baustahl Structural steel ≤ 500 N/mm ²	Baustahl Structural steel > 500 N/mm ²	Auto- matenstahl Free- cutting steel ≤ 1000 N/mm ²	Ver- gütungs- stahl Tempered steel ≤ 1000 N/mm ²	Legierter Stahl Alloyed steel ≤ 1200 N/mm ²	Stahl gehärtet Hardened steel 40 - 60 HRC	VA Stahl VA steel ≤ 850 N/mm ²	VA Stahl VA steel > 850 N/mm ²	Werk- zeugstahl Tool steel ≤ 1000 N/mm ²	Guss Cast iron ≤ 300 HB	Kupfer Copper ≤ 400 N/mm ²	Alu + Legierung Aluminium + alloy ≤ 450 N/mm ²	Uni Uni	Emulsion Emulsion	Minimal Schmie- rung Minimum lubrication	Trocken- bearbei- tung Dry machining
	●	●	●									●		●		
	○	●	●				○				○	●	●	●		○
										●		○				
	●	●	●	●	○		●	●	○						○	●

● empfohlen | recommended ○ bedingt geeignet | partly suitable

Kegelsenker 90° DIN 335 C Countersink 90° DIN 335 C

EXACT
PRÄZISIONSWERKZEUGE

HSS | HSS

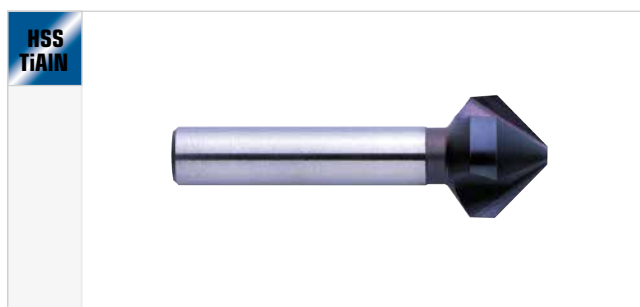
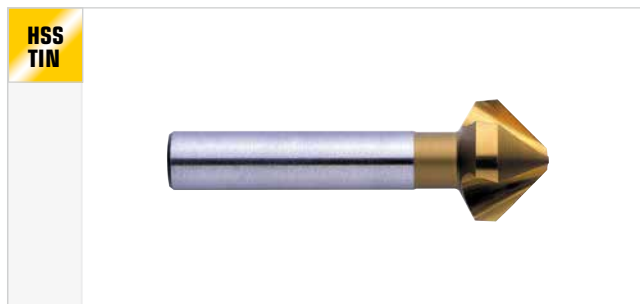
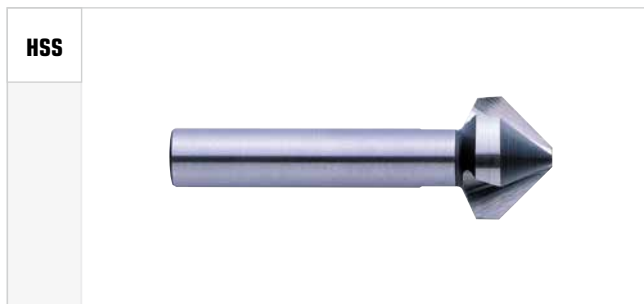

Technische Information

HSS = Hochleistungsschnell-Stahl
DIN 335 C • Mit Zylinderschaft + 3 Schneiden

Anwendung

Zum Senken und Entgraten

Technical Information

HSS = High-speed-steel
DIN 335 C • With cylindrical shaft and 3 flutes

Application

For deburring and countersink

mm	DIN 74		DIN 75		mm	mm	mm	CODE	€	CODE	€	CODE	€	CODE	€
	AF	BF	AF	BF											
4,3	M 2	M 1,8	M 2		40	4	1,3	05501		05541					
5,0	M 2,5	M 2			40	4	1,5	05502		05542					
5,3			M 2,6	M 2,6	40	4	1,5	05503		05543					
5,8			M 3		45	5	1,5	05504		05544					
6,0	M 3	M 2,5			45	5	1,5	05505		05545					
6,3		M 3	M 3,5	M 3	45	5	1,5	05506		05546		51106		51136	
7,0	M 3,5	M 3			50	6	1,8	05507		05547					
7,3			M 4	M 3,5	50	6	1,8	05508		05548					
8,0	M 4	M 3,5			50	6	2,0	05509		05549					
8,3		M 4		M 4	50	6	2,0	05510		05550		51110		51140	
9,4			M 4		50	6	2,2	05511		05551					
10,0	M 5	M 4			50	6	2,5	05512		05552					
10,4		M 5	M 6	M 5	50	6	2,5	05513		05553		51113		51143	
11,5	M 6	M 5			56	8	2,8	05514		05554					
12,4		M 6		M 6	56	8	2,8	05515		05555		51115		51145	
13,4			M 8		56	8	2,9	05516		05556					
15,0	M 8	M 6			60	10	3,2	05517		05557		51117			
16,5		M 8	M 10	M 8	60	10	3,2	05518		05558		51118		51148	
19,0	M 10	M 8			63	10	3,5	05519		05559					
20,5		M 10		M 10	63	10	3,5	05520		05560		51120		51150	
23,0	M 12	M 10			67	10	3,8	05521		05561					
25,0		M 12		M 12	67	10	3,8	05522		05562		51122		51152	
28,0		M 14		M 14	71	12	4,0	05523		05563					
30,0		M 16			71	12	4,2	05524		05564					
31,0				M 16	71	12	4,2	05525		05565		51125		51155	
40,0				M 24	80	15	5,0	05526		05566					

Weitere Abmessungen für TiCN + TiAlN auf Anfrage | Other sizes available on request



Kegelsenker 90° DIN 335 C

Countersink 90° DIN 335 C

Sets HSS | Sets HSS

Kegelsenker • Countersinks



6,3 8,3 10,4 12,4 16,5 20,5	05527	
6,3 10,4 16,5 20,5 25,0	05528	

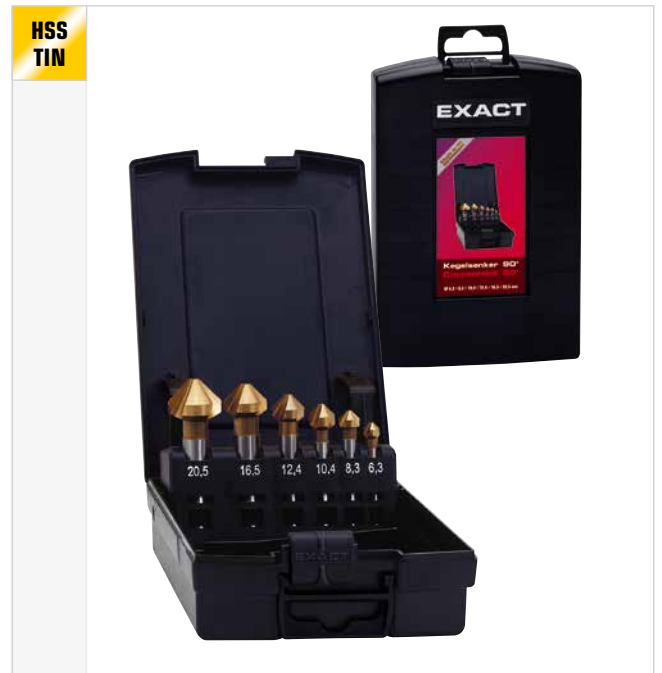

6,3 8,3 10,4 12,4 16,5 20,5	05567	
6,3 10,4 16,5 20,5 25,0	05568	



6,3 8,3 10,4 12,4 16,5 20,5	51127	
6,3 10,4 16,5 20,5 25,0	51128	

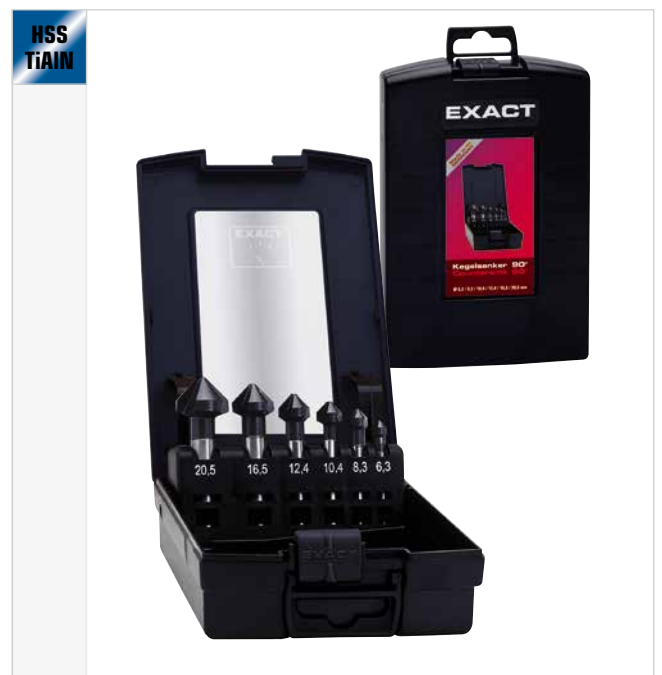

6,3 8,3 10,4 12,4 16,5 20,5	51157	
6,3 10,4 16,5 20,5 25,0	51158	

Kegelsenker 90° DIN 335 C

Countersink 90° DIN 335 C

EXACT
 PRAZISIONSWERKZEUGE

Kegelsenker • Countersinks

HSS-E | HSS-E



HSS-E



HSS-E
TIN

Für rostfreie Stähle (VA-Material / INOX / V2A / V4A / Nirosta)
For stainless steel (VA-material / INOX / V2A / V4A / Nirosta)

Für rostfreie Stähle (VA-Material / INOX / V2A / V4A / Nirosta)
For stainless steel (VA-material / INOX / V2A / V4A / Nirosta)

Technische Information

HSS-E = Hochleistungsschnell-Stahl Klasse E
 DIN 335 C • Mit Zylinderschaft und 3 Schneiden

Technical Information

HSS-E = High-speed-steel E-class
 DIN 335 C • With cylindrical shaft and 3 flutes

Anwendung

Zum Senken und Entgraten

Application

For deburring and countersink

	DIN 74 AF	DIN 74 BF	DIN 75 AF	DIN 75 BF				CODE	€		€
6,3		M 3	M 3,5	M 3	45	5	1,5	05706		15706	
8,3		M 4		M 4	50	6	2,0	05710		15710	
10,4		M 5	M 6	M 5	50	6	2,5	05713		15713	
12,4		M 6		M 6	56	8	2,8	05715		15715	
15,0	M 8	M 6			56	8	2,8	05717		15717	
16,5		M 8	M 10	M 8	60	10	3,2	05718		15718	
20,5		M 10		M 10	63	10	3,5	05720		15720	
25,0		M 12		M 12	67	10	3,8	05722		15722	
31,0				M 16	71	12	4,2	05725		15725	

Sets HSS-E | Sets HSS-E

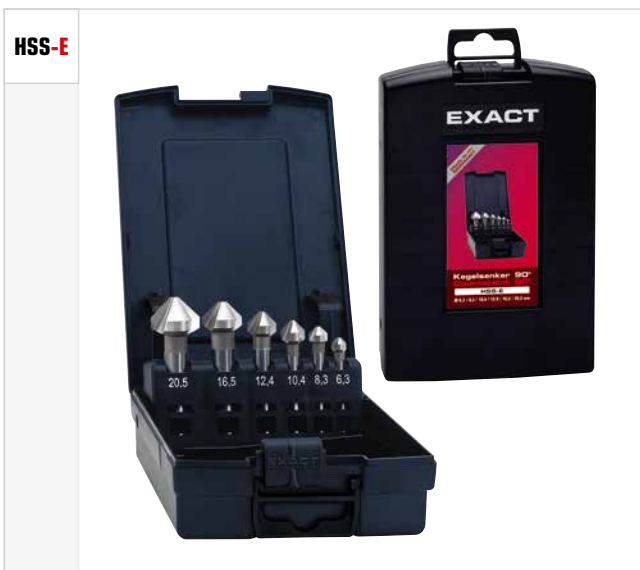

HSS-E



HSS-E
TIN

Für rostfreie Stähle (VA-Material / INOX / V2A / V4A / Nirosta)
For stainless steel (VA-material / INOX / V2A / V4A / Nirosta)

Für rostfreie Stähle (VA-Material / INOX / V2A / V4A / Nirosta)
For stainless steel (VA-material / INOX / V2A / V4A / Nirosta)

INHALT	CODE	€ SET
6,3 8,3 10,4 12,4 16,5 20,5	05727	

INHALT	CODE	€ SET
6,3 8,3 10,4 12,4 16,5 20,5	15727	

Kegelsenker 90° DIN 335 C Countersink 90° DIN 335 C

PM / HM | PM / HM



PM

Für Hardox 400 / VA / Titan / Titanlegierung
For hardox 400 / VA / Titan / Titan alloy



HM

Speziell für zähe Materialien, wie Stähle bis 60 HRC, Hardox 400/500, Titan und Titanlegierungen, Creusabro, Inconel, Nimonic, Monel, Hastelloy, Magnan-Hartstahl

Technische Information

PM = Pulvermetallurgisches Metall
HM = Hartmetall
DIN 335 C • Mit Zylinderschaft und 3 Schneiden

Technical Information

PM = Powder-metallurgy metal
HM = Hard metal
DIN 335 C • With cylindrical shaft and 3 flutes

Anwendung

Zum Senken und Entgraten

Application

For deburring and countersink

	DIN 74 AF	DIN 74 BF	DIN 75 AF	DIN 75 BF				CODE	€	CODE	€
6,3		M 3	M 3,5	M 3	45	5	1,5	50731		05610	
8,3		M 4		M 4	50	6	2,0	50732		05611	
10,4		M 5	M 6	M 5	50	6	2,5	50733		05612	
12,4		M 6		M 6	56	8	2,8	50734		05613	
16,5		M 8	M 10	M 8	60	10	3,2	50735		05615	
20,5		M 10		M 10	63	10	3,5	50736		05616	
25,0		M 12		M 12	67	10	3,8	50737		05617	
31,0				M 16	71	12	4,2	-		05618	

Sets PM / HM | Sets PM / HM

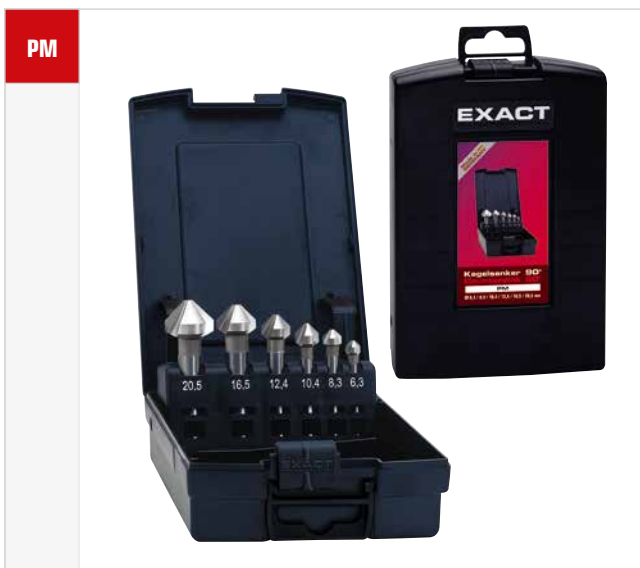

PM

Für Hardox 400 / VA / Titan / Titanlegierung
For hardox 400 / VA / Titan / Titan alloy

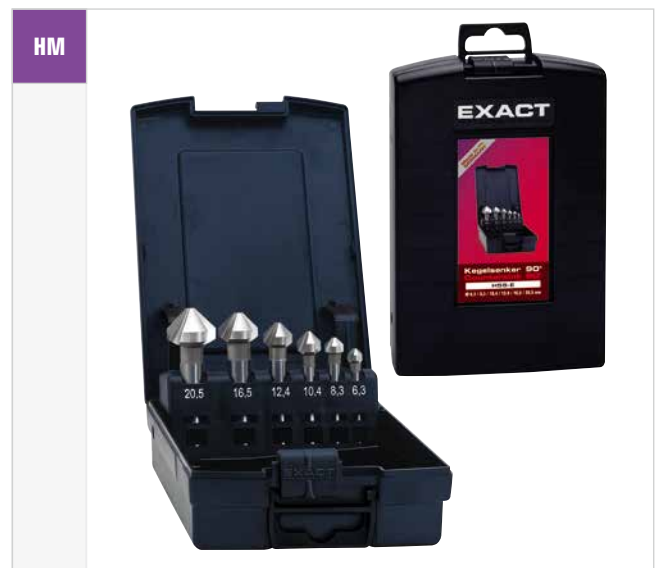

HM

Speziell für zähe Materialien, wie Stähle bis 60 HRC, Hardox 400/500, Titan und Titanlegierungen, Creusabro, Inconel, Nimonic, Monel, Hastelloy, Magnan-Hartstahl

INHALT	CODE	€ SET
6,3 8,3 10,4 12,4 16,5 20,5	50739	

INHALT	CODE	€ SET
6,3 8,3 10,4 12,4 16,5 20,5	05619	

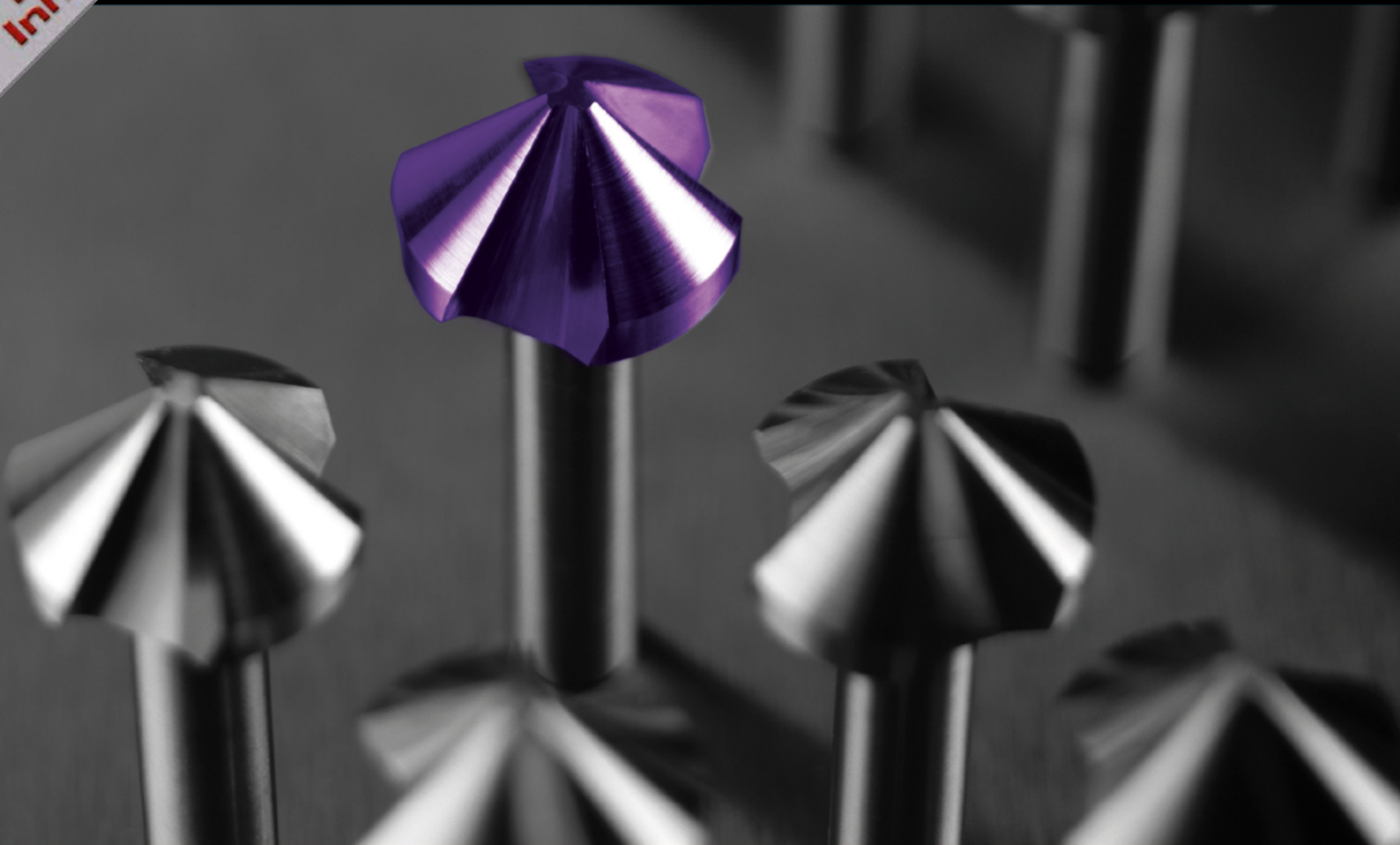

TITAN PRO

Beschichtung | Coating

BESCHREIBUNG

Diese Neuentwicklung ist eine TIALN / TIN Kombinationsschicht und verfügt über ein sehr gutes Verschleißverhalten, sowie gute thermische Stabilität. TITAN-PRO Beschichtungen sind universell einsetzbar und für die Bearbeitung von hochfesten Materialien geeignet.

DESCRIPTION

This new development is a combination of TIALN and TIN coating. It combines excellent wear resistance with good thermal stability. TITAN-PRO coating can be used universally and its suitable for high-strength materials.

TECHNISCHE INFORMATION

Beschichtungsmaterial: TIALN / TIN
 Schichtfarbe: Violett
 Schichtstruktur: Multilayer
 Schichtstärke: bis 2 µm
 Oberflächenhärte: ca. 3100 HV
 Anwendungstemperatur: bis 650 °C

TECHNICAL INFORMATION

Coating: TIALN / TIN
 Layer colour: Violet
 Layer: multilayer
 Layer thickness: up to 2 µm
 Surface hardness: ca. 3100 HV
 Temperature: up to 650 °C

VORTEILE

- **Optimale Standzeiten**
- **Geringer Reibungskoeffizient**
- **Höhere Schnittgeschwindigkeit**
- **Prozesskostenoptimierung**
- **Ca. 25 % mehr Leistung**









ADVANTAGES

- **Optimum service life**
- **A low coefficient of friction**
- **Higher cutting speed**
- **Process cost optimisation**
- **Appr. 25% higher performance**

Kegelsenker 90° | Countersinks 90°

HSS
TitanPro



								
6,3	M 3	M 3,5	M 3	45	5	1,5	09023	
8,3	M 4		M 4	50	6	2,0	09024	
10,4	M 5	M 6	M 5	50	6	2,5	09025	
12,4	M 6		M 6	56	8	2,8	09026	
16,5	M 8	M 10	M 8	60	10	3,2	09027	
20,5	M 10		M 10	63	10	3,5	09028	

Technische Information

HSS = Hochleistungsschnell-Stahl
DIN 335 C • Mit Zylinderschaft + 3 Schneiden

Anwendung

Zum Senken und Entgraten

Technical Information

HSS = High-speed-steel
DIN 335 C • With cylindrical shaft and 3 flutes



Application

For deburring and countersink

Set Kegelsenker 90° | Set Counterink 90°

HSS
TitanPro



		
6,3 8,3 10,4 12,4 16,5 20,5	09029	

Kegelsenker 90° ≈ DIN 335 C

Countersink 90° ≈ DIN 335 C

Lang | Long

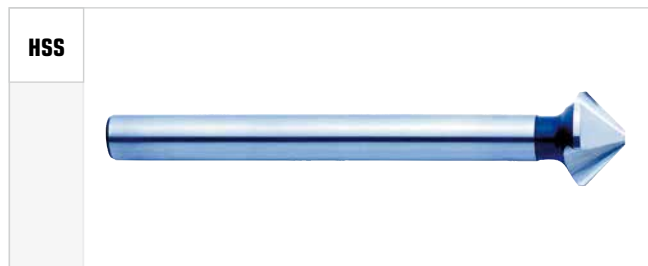

Technische Information

HSS = Hochleistungsschnell-Stahl
Kopf nach DIN 335 C • Mit Zylinderschaft und 3 Schneiden

Anwendung





Zum Senken und Entgraten

Technical Information

HSS = High-speed-steel
Head like DIN 335 C • With cylindrical shaft and 3 flutes

Application

For deburring and countersink

				CODE	€
6,3	85	5	1,5	50701	
8,3	85	6	2,0	50702	
10,4	88	6	2,5	50703	
12,4	108	8	2,8	50704	
16,5	112	10	3,2	50705	
20,5	115	10	3,5	50706	
25,0	118	10	3,8	50707	

Set lang | Set long

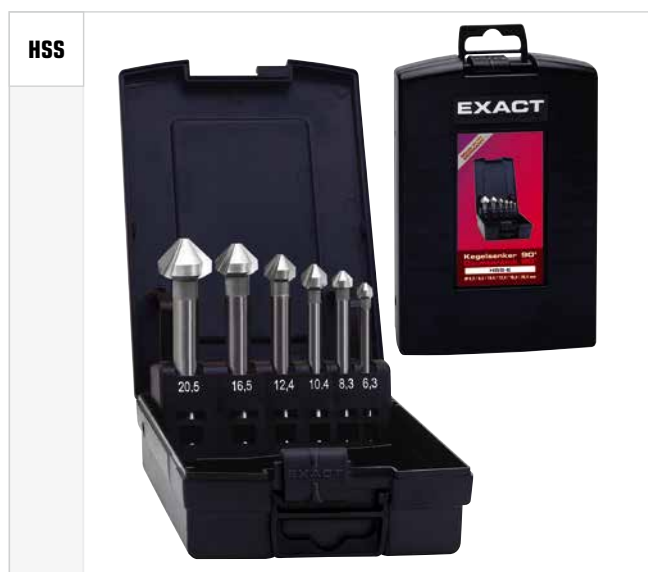

Technische Information

HSS = Hochleistungsschnell-Stahl
Kopf nach DIN 335 C • Mit Zylinderschaft und 3 Schneiden

Anwendung

Zum Senken und Entgraten

Technical Information

HSS = High-speed-steel
Head like DIN 335 C • With cylindrical shaft and 3 flutes

Application

For deburring and countersink

INHALT	CODE	€ SET
6,3 8,3 10,4 12,4 16,5 20,5	50708	

HSS	Einsatz Kegelsenker 90° Application Countersinks 90°															
	Baustahl Structural steel	Baustahl Structural steel	Auto- matenstahl Free- cutting steel	Ver- gütungs- stahl Tempered steel	Legierter Stahl Alloyed steel	Stahl gehärtet Hardened steel	VA Stahl VA steel	VA Stahl VA steel	Werk- zeugstahl Tool steel	Guss Cast iron	Kupfer Copper	Alu + Legierung Aluminium + alloy	Uni Uni	Emulsion	Minimal Schmie- rung Minimum lubrication	Trocken- bearbei- tung Dry machining
	≤ 500 N/mm ²	> 500 N/mm ²	≤ 1000 N/mm ²	≤ 1000 N/mm ²	≤ 1200 N/mm ²	40 - 60 HRC	≤ 850 N/mm ²	> 850 N/mm ²	≤ 1000 N/mm ²	≤ 300 HB	≤ 400 N/mm ²	≤ 450 N/mm ²				
	●	●	●									●		●		○

● empfohlen | recommended ○ bedingt geeignet | partly suitable

Kegelsenker 90° ≈ DIN 335 C

Countersink 90° ≈ DIN 335 C

Extra lang | Extra long

HSS



Technische Information

HSS = Hochleistungsschnell-Stahl
Kopf nach DIN 335 C • Mit Zylinderschaft und 3 Schneiden

Anwendung

Zum Senken und Entgraten

Technical Information

HSS = High-speed-steel
Head like DIN 335 C • With cylindrical shaft and 3 flutes

Application

For deburring and countersink

				CODE	€
6,3	154	5	1,5	50721	
8,3	155	6	2,0	50722	
10,4	157	6	2,5	50723	
12,4	158	8	2,8	50724	
16,5	161	10	3,2	50725	
20,5	164	10	3,5	50726	

Set extra lang | Set extra long

HSS



Technische Information

HSS = Hochleistungsschnell-Stahl
Kopf nach DIN 335 C • Mit Zylinderschaft und 3 Schneiden

Anwendung

Zum Senken und Entgraten

Technical Information

HSS = High-speed-steel
Head like DIN 335 C • With cylindrical shaft and 3 flutes

Application

For deburring and countersink

INHALT	CODE	€ SET
6,3 8,3 10,4 12,4 16,5 20,5	50727	

HSS	Einsatz Kegelsenker 90° Application Countersinks 90°															
	Baustahl Structural steel	Baustahl Structural steel	Auto- matenstahl Free- cutting steel	Ver- gütungs- stahl Tempered steel	Legierter Stahl Alloyed steel	Stahl gehärtet Hardened steel	VA Stahl VA steel	VA Stahl VA steel	Werk- zeugstahl Tool steel	Guss Cast iron	Kupfer Copper	Alu + Legierung Aluminium + alloy	Uni	Emulsion	Minimal Schmie- rung Minimum lubrication	Trocken- bearbei- tung Dry machining
	≤ 500 N/mm ²	> 500 N/mm ²	≤ 1000 N/mm ²	≤ 1000 N/mm ²	≤ 1200 N/mm ²	40 - 60 HRC	≤ 850 N/mm ²	> 850 N/mm ²	≤ 1000 N/mm ²	≤ 300 HB	≤ 400 N/mm ²	≤ 450 N/mm ²				
	●	●	●									●		●		○

● empfohlen | recommended ○ bedingt geeignet | partly suitable

Kegelsenker 90° DIN 335 D Countersink 90° DIN 335 D

EXACT
PRÄZISIONSWERKZEUGE

Mit Morsekegelschaft | With morse taper shaft

HSS



HSS
TIN



Technische Information

HSS = Hochleistungsschnell-Stahl
DIN 335 D • Mit Morsekegel-Schaft und 3 Schneiden

Anwendung

Zum Senken und Entgraten

Technical Information

HSS = High-speed-steel
DIN 335 D • With morse taper shaft and 3 flutes

Application

For deburring and countersink

mm	DIN 74 AF		DIN 74 BF		DIN 75 AF		DIN 75 BF		mm	mm	CODE	€	CODE	€
	M 8	M 6	M 8	M 10	M 8	M 10	M 12	M 14						
15,0									85	1	3,2	05741		
16,5									85	1	3,2	05742		
19,0	M 10	M 8							100	2	3,5	05743		
20,5		M 10							100	2	3,5	05744		
23,0	M 12	M 10							106	2	3,8	05745		
25,0		M 12							106	2	3,8	05746	50741	
26,0	M 14								106	2	3,8	05747		
28,0		M 14							112	2	4,0	05748		
30,0	M 16								112	2	4,2	05749		
31,0		M 16							112	2	4,2	05750	50742	
34,0	M 18	M 18							118	2	4,5	05751		
37,0	M 20	M 20							118	2	4,8	05752	50743	
40,0									140	3	10,0	05753	50744	
45,0				M 22					145	3	12,0	05757		
50,0									150	3	14,0	05754	50745	
63,0									180	4	16,0	05755	50746	
80,0									190	4	22,0	05756	50747	

HSS	Einsatz Kegelsenker 90° Application Countersinks 90°															
	Baustahl	Baustahl	Auto- matenstahl	Ver- gütungs- stahl	Legierter Stahl	Stahl gehärtet	VA Stahl	VA Stahl	Werk- zeugstahl	Guss	Kupfer	Alu + Legierung	Uni	Emulsion	Minimal Schmie- rung	Trocken- bearbei- tung
	Structural steel	Structural steel	Free- cutting steel	Tempered steel	Alloyed steel	Hardened steel	VA steel	VA steel	Tool steel	Cast iron	Copper	Aluminium + alloy	Uni	Emulsion	Minimum lubrication	Dry machining
	≤ 500 N/ mm ²	> 500 N/ mm ²	≤ 1000 N/ mm ²	≤ 1000 N/ mm ²	≤ 1200 N/ mm ²	40 - 60 HRC	≤ 850 N/ mm ²	> 850 N/ mm ²	≤ 1000 N/ mm ²	≤ 300 HB	≤ 400 N/ mm ²	≤ 450 N/ mm ²				
	●	○	○											●		○
	○	●	●				○				○	●	●	●		○

● empfohlen | recommended ○ bedingt geeignet | partly suitable

Kegelsenker 90° Countersink 90°

Handentgrater | Hand deburring tool



HSS
3 S

Technische Information

HSS = Hochleistungsschnell-Stahl
3 S = 3 Schneiden

Anwendung

Zum Senken und Entgraten

Technical Information

HSS = High-speed-steel
3 S = 3 flutes

Application

For deburring and countersink

		CODE	€
12,4	2,8	05761	
15,0	3,2	05762	
16,5	3,2	05763	
20,5	3,5	05764	
25,0	3,8	05765	

1-Schneiden-Senker | 1-Flute Countersink



HSS

Technische Information

HSS = Hochleistungsschnell-Stahl
Mit Zylinderschaft und 1 Schneide. Spitz zulaufend, ohne Spiegel.

Anwendung

Für leichte Senk- und Entgratarbeiten.

Technical Information

HSS = High-speed-steel
With cylindrical shaft and 1 flute. Pointed, without plane top.

Application

For easy deburring and countersink jobs.

			CODE	€
6,0	40	6	50801	
8,0	45	8	50802	
10,0	45	8	50803	
12,0	48	8	50804	
16,0	50	10	50805	
20,0	55	10	50806	
25,0	68	12	50807	
30,0	70	12	50808	

Kegelsenker 60° + 75° Countersink 60° + 75°

Kegelsenker 60° | Countersinks 60°

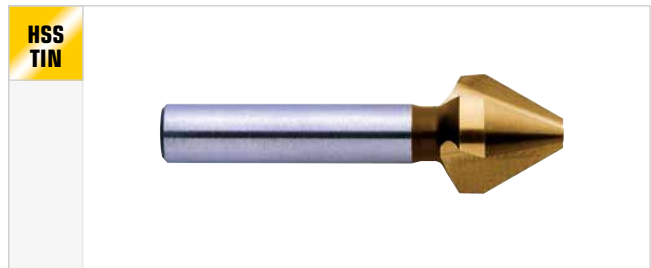
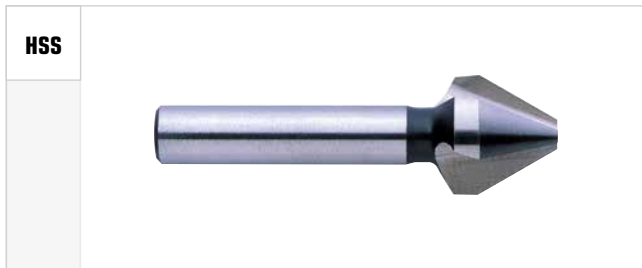

Technische Information

HSS = Hochleistungsschnell-Stahl
TIN = Mit Titan-Nitrid Beschichtung
DIN 334 C • Mit Zylinderschaft und 3 Schneiden

Technical Information









HSS = High-speed-steel
TIN = With titanium-nitride coating
DIN 334 C • With cylindrical shaft and 3 flutes

Anwendung

Zum Senken und Entgraten

Application

For deburring and countersink

							
6,3	45	5	1,7	05581		50751	
8,0	50	6	2,1	05582		50752	
10,0	53	6	2,6	05583		50753	
12,5	56	8	3,3	05584		50754	
16,0	63	10	4,1	05585		50755	
20,5	67	10	5,1	05586		50756	
25,0	71	10	6,4	05587		50757	
31,5	76	12	10,1	05588		50758	

Kegelsenker 75° | Countersinks 75°



Technische Information

HSS = Hochleistungsschnell-Stahl
TIN = Mit Titan-Nitrid Beschichtung
Werknorm Form C • Mit Zylinderschaft und 3 Schneiden

Technical Information









HSS = High-speed-steel
TIN = With titanium-nitride coating
Work standard form C • With cylindrical shaft and 3 flutes

Anwendung

Zum Senken und Entgraten

Application

For deburring and countersink

							
6,3	45	5	1,6	50781		51781	
8,3	50	6	2,2	50782		51782	
10,4	51	6	2,7	50783		51783	
12,4	55	8	3,2	50784		51784	
16,5	61	10	3,7	50785		51785	
20,5	65	10	4,2	50786		51786	
25,0	69	10	5,2	50787		51787	

Kegelsenker 120° Countersink 120°

Kegelsenker 120° | Countersinks 120°



Technische Information

HSS = Hochleistungsschnell-Stahl
 TIN = Mit Titan-Nitrid Beschichtung
 Werksnorm Form C • Mit Zylinderschaft und 3 Schneiden

Technical Information

HSS = High-speed-steel
 TIN = With titanium-nitride coating
 Work standard form C • With cylindrical shaft and 3 flutes

Anwendung

Zum Senken und Entgraten

Application

For deburring and countersink

6,3	44,0	5	1,7	50791		51791	
8,3	48,5	6	2,2	50792		51792	
10,4	50,0	6	2,7	50793		51793	
12,4	53,0	8	3,2	50794		51794	
16,5	56,0	10	3,7	50795		51795	
20,5	59,0	10	4,2	50796		51796	
25,0	61,0	10	5,2	50797		51797	

Einsatz Kegelsenker 60°/75°/120° | Application Countersinks 60°/75°/120°

	Baustahl Structural steel ≤ 500 N/mm ²	Baustahl Structural steel > 500 N/mm ²	Auto- matenstahl Free- cutting steel ≤ 1000 N/mm ²	Ver- gütungs- stahl Tempered steel ≤ 1000 N/mm ²	Legierter Stahl Alloyed steel ≤ 1200 N/mm ²	Stahl gehärtet Hardened steel 40 - 60 HRC	VA Stahl VA steel ≤ 850 N/mm ²	VA Stahl VA steel > 850 N/mm ²	Werk- zeugstahl Tool steel ≤ 1000 N/mm ²	Guss Cast iron ≤ 300 HB	Kupfer Copper ≤ 400 N/mm ²	Alu + Legierung Aluminium + alloy ≤ 450 N/mm ²	Uni Uni	Emulsion Emulsion	Minimal Schmie- rung Minimum lubrication	Trocken- bearbei- tung Dry machining
	●	●	○									●				○
	○	●	●				○				○	●	●	●		○
	●	●	○									●				○
	○	●	●				○				○	●	●	●		○
	●	●	○									●				○
	○	●	●				○				○		●	●		○

● empfohlen | recommended ○ bedingt geeignet | partly suitable



Querlochsenker 90° Deburring Countersinks 90°

EXACT
PRÄZISIONSWERKZEUGE

Querlochsenker • Deburring Countersinks

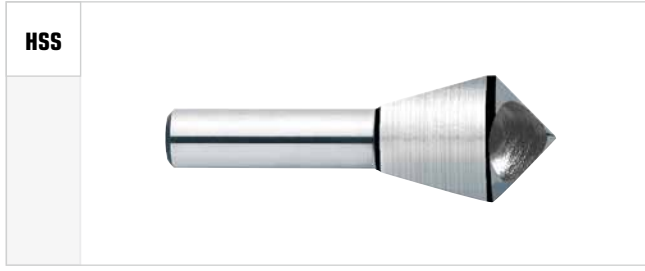

Technische Information

HSS = Hochleistungsschnell-Stahl
TIN = Mit Titan-Nitrid Beschichtung
Mit Zylinderschaft

Anwendung

Besonders geeignet für langspanende Werkstoffe

Technical Information

HSS = High-speed-steel
TIN = With titanium-nitride coating
With cylindrical shaft

Application

Particularly suitable for long-chip materials

HSS					CODE HSS	€	CODE HSS	€
5	2 - 5	45	6	10	05401		05431	
10	5 - 10	48	8	14	05402		05432	
15	10 - 15	65	10	21	05403		05433	
20	15 - 20	84	12	28	05404		05434	
25	20 - 25	102	12	35	05405		05435	
30	25 - 30	115	15	44	05406			
35	30 - 35	127	15	48	05407			
40	35 - 40	136	15	53	05408			
50	40 - 50	166	20	60	05409			

Sets | Sets



No. 5 / 10 / 15 / 20	05410	

No. 5 / 10 / 15 / 20	05440	



Querlochsenker 90° Deburring Countersinks 90°



Technische Information
 HSS-E = Hochleistungsschnell-Stahl Klasse E
 TIN = Mit Titan-Nitrid Beschichtung
 Mit Zylinderschaft

Technical Information
 HSS-E = High-speed-steel E-class
 TIN = With titanium-nitride coating
 With cylindrical shaft

Anwendung
 Besonders geeignet für langspanende Werkstoffe

Application
 Particularly suitable for long-chip materials

HSS-E						CODE HSS-E	€	CODE HSS-E	€
5	2 - 5	45	6	10	05421		05441		
10	5 - 10	48	8	14	05422		05442		
15	10 - 15	65	10	21	05423		05443		
20	15 - 20	84	12	28	05424		05444		
25	20 - 25	102	12	35	05425		05445		
30	25 - 30	115	15	44	05427				
35	30 - 35	127	15	48	05428				
40	35 - 40	136	15	53	05429				
50	40 - 50	166	20	60	05430				

Sets | Sets

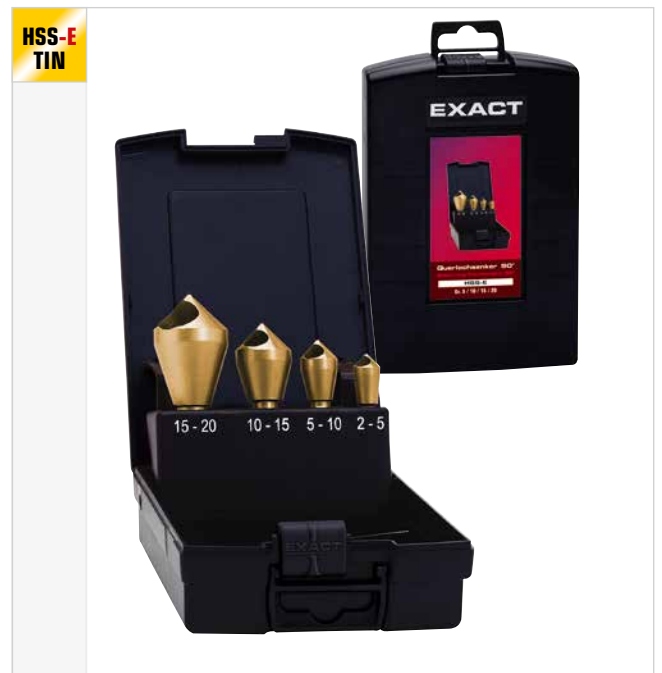

No. 5 / 10 / 15 / 20	05426	

No. 5 / 10 / 15 / 20	05446	



Flachsenker DIN 373 Counterbores DIN 373

EXACT
PRÄZISIONSWERKZEUGE

Flachsenker • Counterbores

Für Kernloch | For core holes

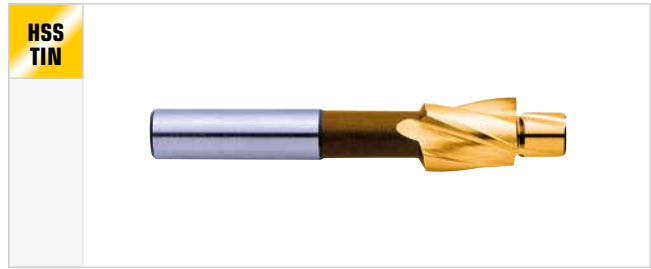

Technische Information

HSS = Hochleistungsschnell-Stahl
TIN = Mit Titan-Nitrid Beschichtung
DIN 373 • Mit Zylinderschaft und festem Führungszapfen
für Kernloch.

Technical Information

HSS = High-speed-steel
TIN = With titanium-nitride coating
DIN 373 • With cylindrical shaft and fixed guide pins
for core holes.

Anwendung

Zur Versenkung von Zylinderkopfschrauben, Sechskant-Schrauben und -muttern. Ideal zum grat- und ratterfreien Senken bei Stahl, Guss und Leichtmetallen.

Application

For countersinking cylindrical head screws, hexagon screws and nuts.

M		mm	mm	mm	CODE	€	CODE	€
M 3	6	2,5	71	5,0	05801		50811	
M 4	8	3,3	71	5,0	05802		50812	
M 5	10	4,2	80	8,0	05803		50813	
M 6	11	5,0	80	8,0	05804		50814	
M 8	15	6,8	100	12,5	05805		50815	
M 10	18	8,5	100	12,5	05806		50816	
M 12	20	10,2	100	12,5	05807		50817	

Sets für Kernloch | Sets for core holes



INHALT	CODE	€
M 3 M 4 M 5 M 6 M 8 M 10	05861	

INHALT	CODE	€
M 3 M 4 M 5 M 6 M 8 M 10	50818	



Flachsenker DIN 373 Counterbores DIN 373

Für Durchgangsloch - fein | For through hole - fine

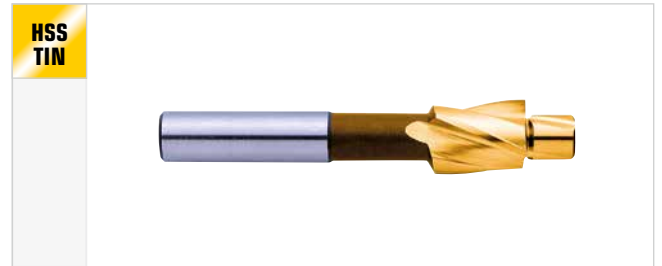

Technische Information

HSS = Hochleistungsschnell-Stahl
 TIN = Mit Titan-Nitrid Beschichtung
 DIN 373 • Mit Zylinderschaft und festem Führungszapfen
für Durchgangsloch, fein.

Anwendung

Zur Versenkung von Zylinderkopfschrauben, Sechskant-Schrauben und -muttern. Ideal zum grat- und ratterfreien Senken bei Stahl, Guss und Leichtmetallen.

Technical Information

HSS = High-speed-steel
 TIN = With titanium-nitride coating
 DIN 373 • With cylindrical shaft and fixed guide pins
for through holes, fine.

Application

For countersinking cylindrical head screws, hexagon screws and nuts.

M		mm	mm	mm	CODE	€	CODE	€
M 3	6	3,2	71	5,0	05821		50821	
M 4	8	4,3	71	5,0	05822		50822	
M 5	10	5,3	80	8,0	05823		50823	
M 6	11	6,4	80	8,0	05824		50824	
M 8	15	8,4	100	12,5	05825		50825	
M 10	18	10,5	100	12,5	05826		50826	
M 12	20	13,0	100	12,5	05827		50827	

Sets für Durchgangsloch - fein | Sets for through hole - fine

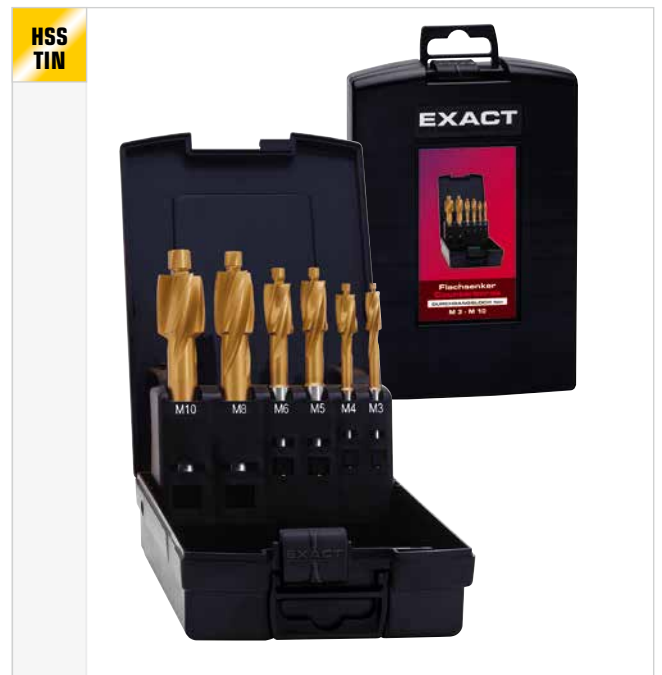

INHALT	CODE	€ SET
M 3 M 4 M 5 M 6 M 8 M 10	05862	

INHALT	CODE	€ SET
M 3 M 4 M 5 M 6 M 8 M 10	50828	

Flachsenker DIN 373 Counterbores DIN 373

EXACT
PRÄZISIONSWERKZEUGE

Für Durchgangsloch - mittel | For through hole - medium

HSS



HSS
TIN



Technische Information

HSS = Hochleistungsschnell-Stahl

TIN = Mit Titan-Nitrid Beschichtung

DIN 373 • Mit Zylinderschaft und festem Führungszapfen

für Durchgangsloch - medium.

Anwendung

Zur Versenkung von Zylinderkopfschrauben, Sechskant-Schrauben und -mutter. Ideal zum grat- und ratterfreien Senken bei Stahl, Guss und Leichtmetallen.

Technical Information

HSS = High-speed-steel

TIN = With titanium-nitride coating

DIN 373 • With cylindrical shaft and fixed guide pins

for through holes - medium.

Application

For countersinking cylindrical head screws, hexagon screws and nuts.

M		mm	mm	mm	CODE	€	CODE	€
M 3	6	3,4	71	5,0	05841		50831	
M 4	8	4,5	71	5,0	05842		50832	
M 5	10	5,5	80	8,0	05843		50833	
M 6	11	6,6	80	8,0	05844		50834	
M 8	15	9,0	100	12,5	05845		50835	
M 10	18	11,0	100	12,5	05846		50836	
M 12	20	13,5	100	12,5	05847		50837	

Für Durchgangsloch - mittel | For through hole - medium

HSS



HSS
TIN



INHALT	CODE	€ SET
M 3 M 4 M 5 M 6 M 8 M 10	05863	

INHALT	CODE	€ SET
M 3 M 4 M 5 M 6 M 8 M 10	50838	

Flachsenker • Counterbores



Mit Morsekegel-Schaft | With morse taper shaft



HSS

Technische Information

HSS = Hochleistungsschnell-Stahl

Anwendung

Zur Versenkung von Zylinderkopfschrauben, Sechskant-Schrauben und -muttern. Ideal zum grat- und ratterfreien Senken bei Stahl, Guss und Leichtmetallen.

Technical Information

HSS = High-speed-steel

Application

For countersinking cylindrical head screws, hexagon screws and nuts.

Für Kernloch | For core hole

M					CODE	€
M 10	18	8,5	150	MK 2	05808	
M 12	20	10,2	150	MK 2	05809	
M 14	24	12,0	190	MK 2	05810	
M 16	26	14,0	190	MK 3	05811	
M 18	30	15,5	190	MK 3	05812	
M 20	33	17,5	190	MK 3	05813	
M 22	36	19,5	205	MK 3	05814	
M 24	40	21,0	205	MK 3	05815	

Für Durchgangsloch - fein | For through hole - fine

M					CODE	€
M 10	18	10,5	150	MK 2	05828	
M 12	20	13,0	150	MK 2	05829	
M 14	24	15,0	190	MK 2	05830	
M 16	26	17,0	190	MK 3	05831	
M 18	30	19,0	190	MK 3	05832	
M 20	33	21,0	190	MK 3	05833	
M 22	36	23,0	205	MK 3	05834	
M 24	40	25,0	205	MK 3	05835	

Für Durchgangsloch - mittel | For through hole - medium

M					CODE	€
M 10	18	11,0	150	MK 2	05848	
M 12	20	13,5	150	MK 2	05849	
M 14	24	15,5	190	MK 2	05850	
M 16	26	17,5	190	MK 3	05851	
M 18	30	20,0	190	MK 3	05852	
M 20	33	22,0	190	MK 3	05853	
M 22	36	24,0	205	MK 3	05854	
M 24	40	26,0	205	MK 3	05855	



M10HSS

BIT-PROGRAMM

BIT-PROGRAM

EXACT®

Stufenbohrer-Bit 216
Step Drill Bit

SGE-Bit® Kombigewindebohrer

SGE-Bit® Combit-tool

Produktinformation ROTAPLUS+

■ metrisch

217
218-219

Senk-Bit

Countersink-Bit

■ metrisch

220

Einschnittgewindebohrer-Bit

Threading-Bit

■ metrisch

221

Spiralbohrer-Bit

Drill-Bit

222

Bit Halter

Bit holder

■ Senk- und Entgrat-Set

■ Universalhalter

■ Handhalter

223

223

223

ClipSet Programm

ClipSets program

■ SGE-Bits® Kombigewindebohrer

■ Einschnittgewindebohrer-Bits

■ Senk-Bits

■ Spiralbohrer-Bits + Senk-Bit

■ Spiralbohrer-Bits + Einschnittgewindebohrer-Bit

224

224

224

225

225

Stufenbohrer-Bit Step Drill Bit

EXACT
PRÄZISIONSWERKZEUGE

HSS | HSS

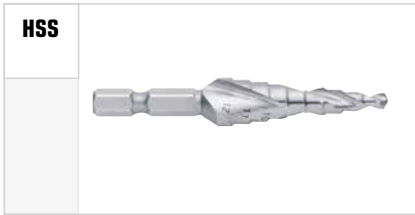

Technische Information

HSS = Hochleistungsschnell-Stahl

Technical Information

HSS = High-speed-steel

TIN

Zusätzliche Oberflächenhärtung:

- Oberflächenhärte ca. 2.500 HV • Schichtstärke bis 2 µm
- Für harte Materialien • Erhöhte Standzeiten
- Höhere Schnittgeschwindigkeit • Temperaturbeständig bis 600° C • Reduziert Kaltaufschweißung

Additional surface hardness:

- Surface treatment ca. 2.500 HV • Layer Thickness up to 2 µm
- For hard materials • Higher tool life
- Higher cutting speeds • Temperature resistant up to 600° C
- Reduces cold weldings

- #### TiAIN
- Oberflächenhärte ca. 3.500 HV • Schichtstärke bis 4 µm
 - Für besonders harte Materialien • Optimale Standzeiten
 - Höchste Schnittgeschwindigkeit • Temperaturbeständig bis 800° C, kein Kühlmittel notwendig
 - Reduziert Kaltaufschweißung

- Surface treatment ca. 3.500 HV • Layer Thickness up to 4 µm
- For hardest materials • Optimized tool life
- Highest cutting speeds
- Temperature resistant up to 800° C, cooling not necessary
- Reduces cold weldings

Anwendung

Für gratfreies Bohren von Blechen, Rohren und Profilen.

Application

For drilling of sheet material, pipes and profiles.

1/4" Bit-Schaft | 1/4" Bit-shaft

mm	mm	mm	mm	mm	CODE	€	CODE	€	CODE	€
27	5	72	6,35	4 - 12	08001		08011		08021	
27	4	81	6,35	4 - 20	08002		08012		08022	
27	4	105	6,35	4 - 30	08003		08013		08023	

Sets HSS | Sets HSS

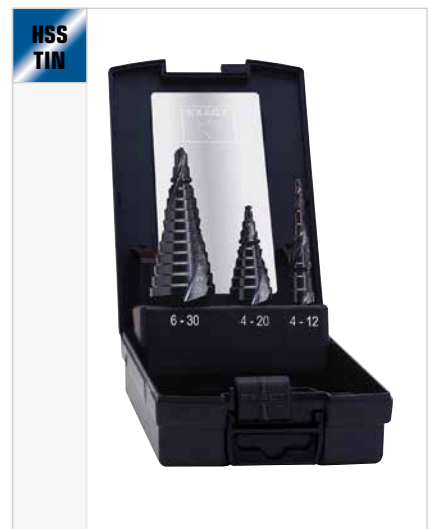
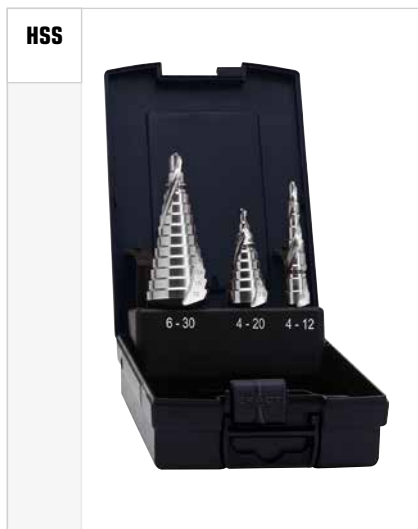

INHALT	CODE	€ SET
4-12 / 4-20 / 4-30	08004	

INHALT	CODE	€ SET
4-12 / 4-20 / 4-30	08014	

INHALT	CODE	€ SET
4-12 / 4-20 / 4-30	08024	

INNOVATION BY

EXACT

PRÄZISIONSWERKZEUGE

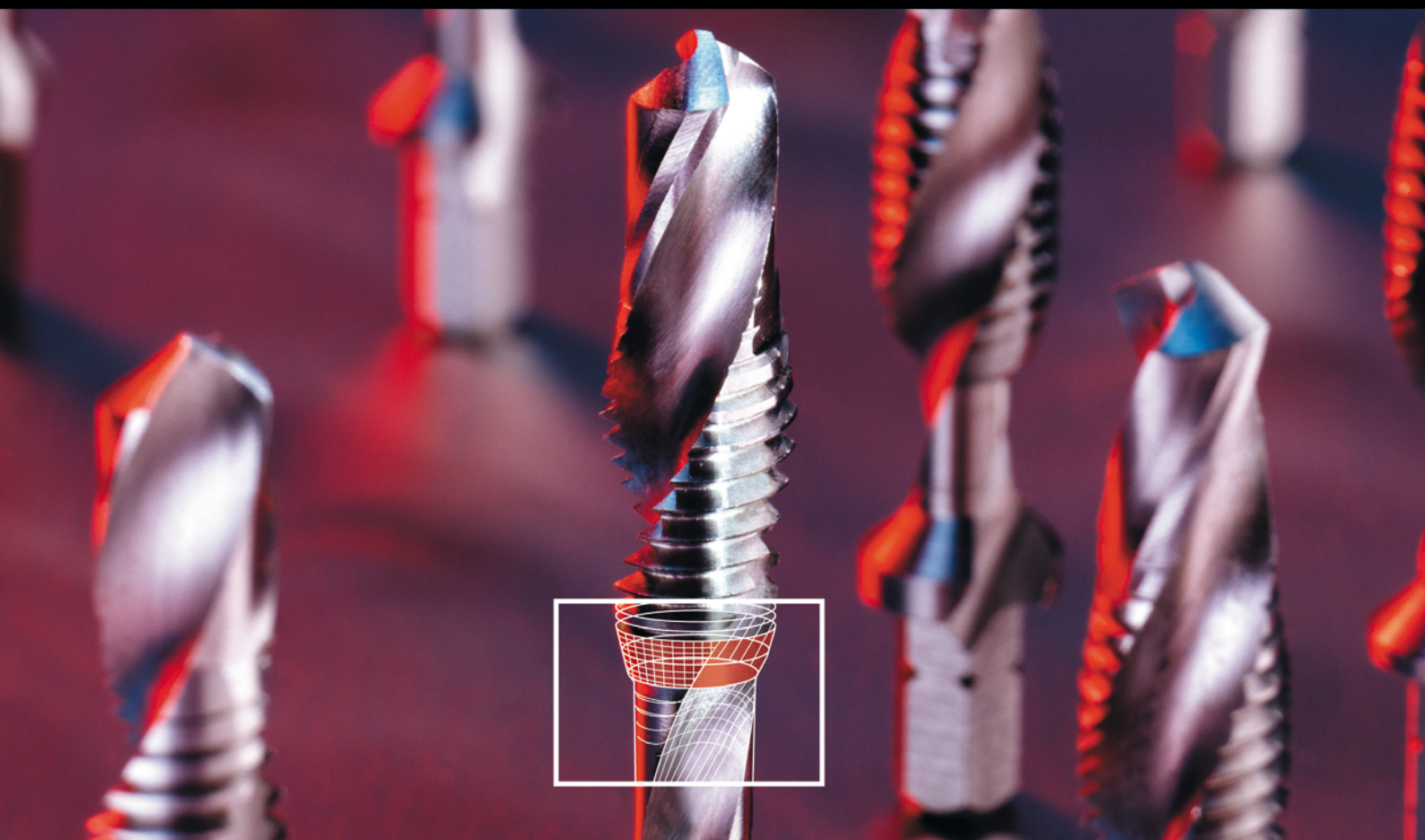

COMBITOOL SGE-BIT®

INNOVATION | INNOVATION

Erhöhte Biegeelastizität
durch wärmebehandelte
Induktionszone

Increased bending
elasticity by
heat-treated
induction zone



3 IN 1 WERKZEUG | 3 IN 1 TOOL



VORTEILE | ADVANTAGES

- Bis zu 50 % höhere Standzeiten
- Reduzierung der Bruchgefahr
- Kernlochbohren, Gewinden und Entgraten in 1 Arbeitsgang!
- Up to 50 % longer service lives
- Reduction in fracture risk
- Drilling, threading and deburring in 1 working step!

SGE-Bit® ROTAPLUS+®



Technische Information

HSS = Hochleistungsschnell-Stahl
1/4" Bit-Antrieb (DIN 3126)

Anwendung

Zum Kernlochbohren, Gewinden und Entgraten in 1 Arbeitsgang.

Technical Information

HSS = High-speed-steel
1/4" Bit drive (DIN 3126)

Application

For drilling, threading and deburring in 1 working step.

M	mm	mm	mm	mm	CODE HSS	€	CODE HSS	€
M 3	0,50	2,5	36	6,5	05901		05921	
M 4	0,70	3,3	39	9,0	05902		05922	
M 5	0,80	4,2	41	10,0	05903		05923	
M 6	1,00	5,0	44	12,0	05904		05924	
M 8	1,25	6,8	50	15,0	05905		05925	
M 10	1,50	8,5	59	18,0	05906		05926	
M 12	1,75	10,2	66	18,0	05907		05927	

Set SGE-Bit® ROTAPLUS+®

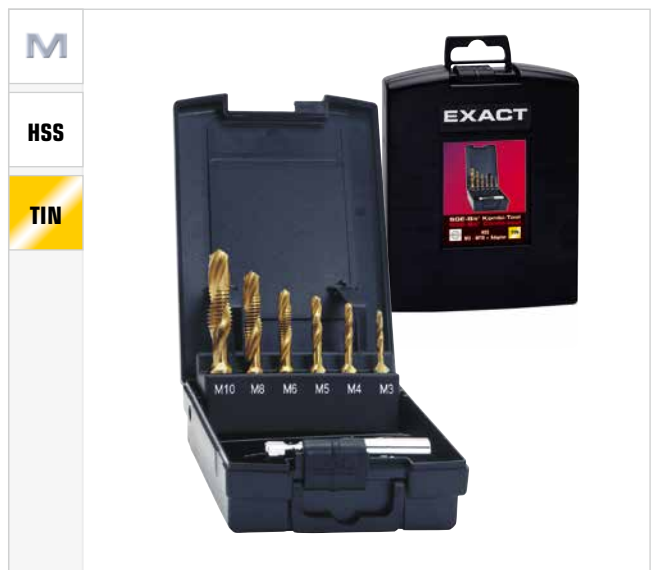
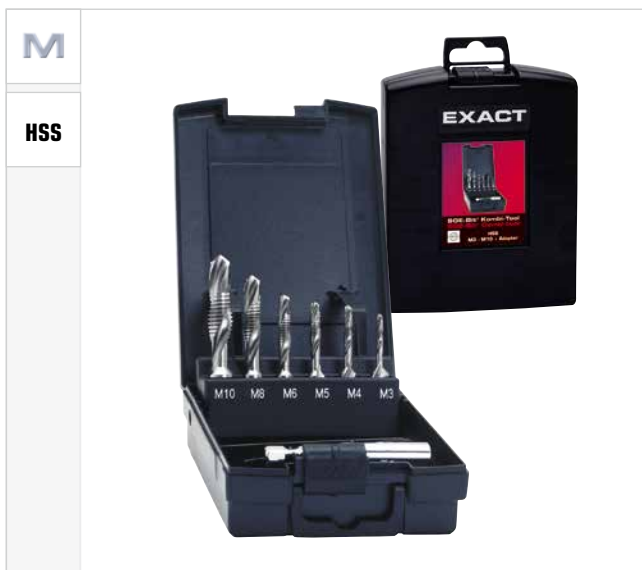

INHALT	CODE HSS	€ SET
M 3 M 4 M 5 M 6 M 8 M 10 + Adapter 825-25	05910	

INHALT	CODE HSS	€ SET
M 3 M 4 M 5 M 6 M 8 M 10 + Adapter 825-25	05930	

SGE-Bit® ROTAPLUS+®



Technische Information

HSS-E = Hochleistungsschnell-Stahl Klasse E
 1/4" Bit-Antrieb (DIN 3126)

Anwendung

Zum Kernlochbohren, Gewinden und Entgraten in 1 Arbeitsgang.

Technical Information

HSS-E = High-speed-steel E-class
 1/4" Bit drive (DIN 3126)

Application

For drilling, threading and deburring in 1 working step.

M	mm	mm	mm	mm	CODE HSS-E	€	CODE HSS-E	€
M 3	0,50	2,5	36	6,5	05870		05880	
M 4	0,70	3,3	39	9,0	05871		05881	
M 5	0,80	4,2	41	10,0	05872		05882	
M 6	1,00	5,0	44	12,0	05873		05883	
M 8	1,25	6,8	50	15,0	05874		05884	
M 10	1,50	8,5	59	18,0	05875		05885	
M 12	1,75	10,2	66	18,0	05876		05886	

Set SGE-Bit® ROTAPLUS+®

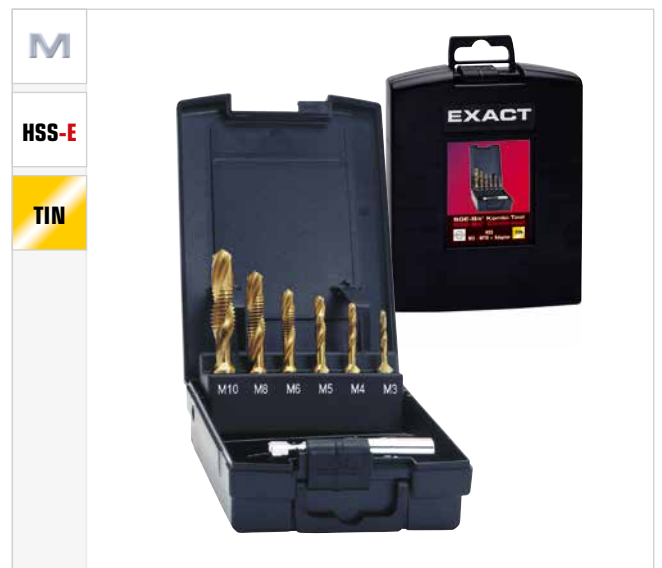
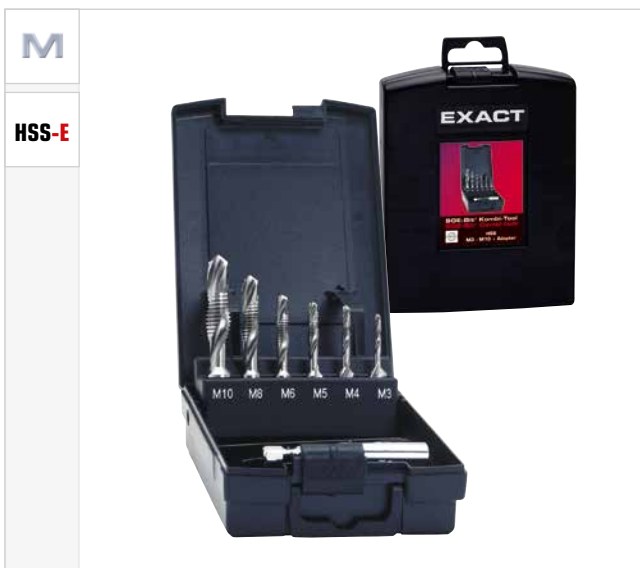

INHALT

CODE
HSS-E

€
SET

M 3 M 4 M 5 M 6 M 8 M 10 + Adapter 825-25 | 05877

INHALT

CODE
HSS-E

€
SET

M 3 M 4 M 5 M 6 M 8 M 10 + Adapter 825-25 | 05887

90° | 90°



Technische Information

HSS = Hochleistungsschnell-Stahl
DIN 335 Form C • 1/4" Bitschaft Antrieb (DIN 3126) und 3 Schneiden

Anwendung



Entgraten, Fasen und Senken

Technical Information

HSS = High-speed-steel
DIN 335 form C • With 1/4 Inch drill shaft (DIN 3126) and 3 flutes

Application



Deburring, chamfering and countersinking

	M		CODE	€		€
6,3	M 3	31	05641		05631	
8,3	M 4	31	05642		05632	
10,4	M 5	34	05643		05633	
12,4	M 6	35	05644		05634	
16,5	M 8	40	05645		05635	
20,5	M 10	41	05646		05636	

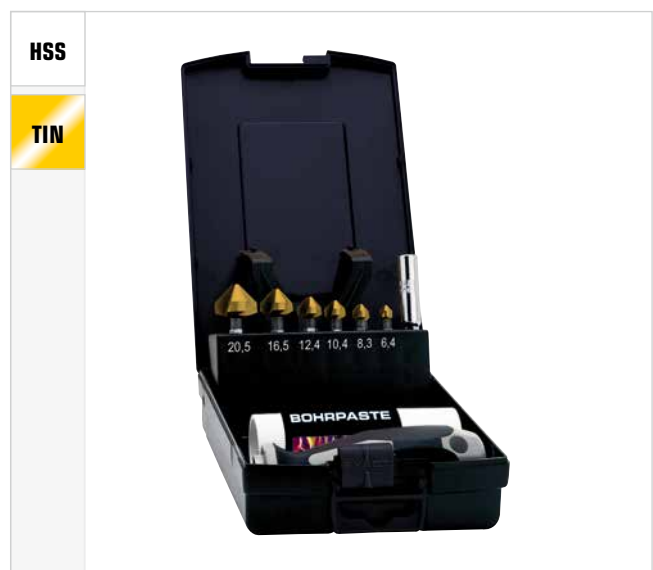
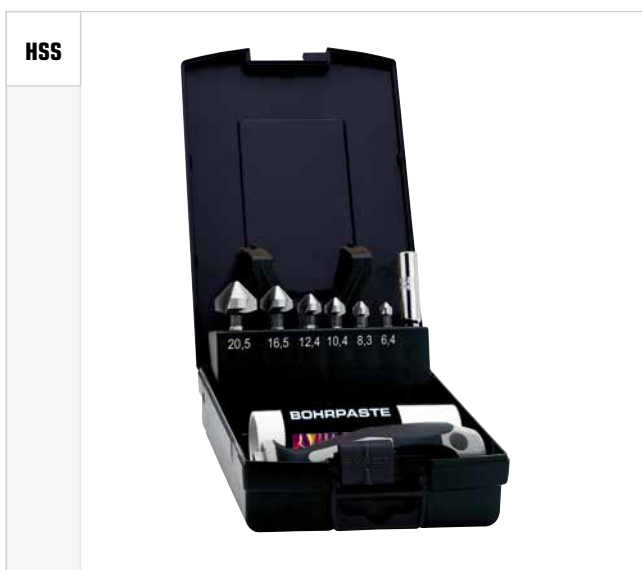
Set Senk-Bits



INHALT	CODE	€
	 HSS	SET
Ø 6,3 - 20,5 mm + Universalhalter 825-25 + Bohrpaste + Handgriff mit 1/4" Innensechskant-aufnahme	05649	

INHALT	CODE	€
	 HSS	SET
Ø 6,3 - 20,5 mm + Universalhalter 825-25 + Bohrpaste + Handgriff mit 1/4" Innensechskant-aufnahme	05639	

Einschnittgewindebohrer-Bit

Threading-Bit



Technische Information

HSS = Hochleistungsschnell-Stahl
 Mit 1/4" Bitschaft Antrieb (DIN 3126).

Anwendung

Werkzeug zum Schneiden von Gewinden mit 1/4" Bitschaft

Technical Information

HSS = High-speed-steel
 With 1/4 Inch drill shaft (DIN 3126).

Application

For cutting threads with 1/4 Inch drill shaft

M	mm	mm	mm	CODE	€
M 3	0,50	2,5	33	05931	
M 4	0,70	3,3	35	05932	
M 5	0,80	4,2	36	05933	
M 6	1,00	5,0	39	05934	
M 8	1,25	6,8	40	05935	
M 10	1,50	8,5	41	05936	

Set | Set



INHALT	CODE	€ SET
M 3 M 4 M 5 M 6 M 8 M 10 + Adapter	05937	



Technische Information

HSS = Hochleistungsschnell-Stahl
Mit 1/4" Bitschaft Antrieb (DIN 3126).

Anwendung

Leistungsstarker Spiralbohrer geeignet für alle normalen Bohrarbeiten in allgemein gängigen Werkstoffen.

Technical Information

HSS = High-speed-steel
With 1/4 Inch drill shaft (DIN 3126).

Application

High capacity twist drill bit suitable for all normal drilling work in conventional materials.

mm	mm	mm	CODE	€	CODE	€
1,5	10	32	05942		50871	
2,0	12	34	05943		50872	
2,5	14	36	05944		50873	
3,0	16	38	05945		50874	
3,3	18	40	05946		50875	
3,5	18	40	05947		50876	
4,0	20	44	05948		50877	
4,2	20	45	05949		50878	
4,5	24	46	05950		50879	
5,0	26	50	05951		50880	
5,5	26	50	05952		50881	
6,0	26	50	05953		50882	
6,5	30	50	05954		50883	
6,8	30	50	05955		50884	
7,0	30	50	05956		50885	
7,5	32	51	05957		50886	
8,0	32	51	05958		50887	
8,5	33	53	05959		50888	
9,0	33	53	05960		50889	
9,5	38	54	05961		50890	
10,0	38	54	05962		50891	
10,2	38	54	05963		50892	

Set | Set



INHALT

2,0 / 2,5 / 3,0 / 4,0 / 5,0 / 6,0 / 8,0

CODE

05964

€ SET

INHALT

2,0 / 2,5 / 3,0 / 4,0 / 5,0 / 6,0 / 8,0

CODE

50896

€ SET



Senk- und Entgrat-Set | Deburring Set

HSS



Mit 1/4" Bitschaft Antrieb (DIN 3126) und 3 Schneiden.
Senk-Kopf nach DIN 335 Form C.



With 1/4 Inch drill shaft (DIN 3126) and 3 flutes.
Countersink head in conformity with DIN 335 form C.

		
Handgriff mit 1/4" Innensechskant-Aufnahme + Universalhalter 1/4" Sechskant-Antrieb (pat.) zur Verlängerung und für Maschineneinsatz + Senk-Bits 90° 10,4 / 16,5 mm	05650	

Universalhalter | Universal holder





Mit 1/4" Antrieb zur Verlängerung.
With 1/4 Inch drive for extension.

		
Universalhalter 60 mm Länge	05653	

Handhalter | Handle



Mit 1/4" Aufnahme.
With 1/4 inch holder.

		
Handhalter 130 mm Länge	05652	



ClipSet Programm

ClipSet program

EXACT
PRÄZISIONSWERKZEUGE

Bits | Bits

ClipSets



SGE-Bits®

SGE-Bits®

INHALT	CODE	€ SET
M 3 M 4 M 5 M 6 M 8 M 10 + Adapter	50901	
M 3 M 4 M 5 M 6 M 8 M 10 M 12 + Adapter	50900	



SGE-Bits®

SGE-Bits®

TIN = Mit Titan-Nitrid Beschichtung
TIN = With titanium-nitride coating

INHALT	CODE	€ SET
M 3 M 4 M 5 M 6 M 8 M 10 + Adapter	50902	
M 3 M 4 M 5 M 6 M 8 M 10 M 12 + Adapter	50909	



Einschnittgewindebohrer-Bits

Threading-Bit

INHALT	CODE	€ SET
M 3 M 4 M 5 M 6 M 8 M 10 + Adapter	50903	



Senk-Bits

Countersink-Bits



INHALT	CODE	€ SET
Ø 6,3 8,3 10,4 12,4 16,5 + Adapter	50904	



Spiralbohrer-Bits | Drill-Bits





Spiralbohrer-Bits + Senk-Bit Drill-Bits + Countersink-Bit

		
Spibo-Bits Ø 3,0 4,0 4,5 5,0 5,5 6,0 8,0 10,0 + Senk-Bit Ø 10,4 + Adapter		
		50905





Spiralbohrer-Bits + Senk-Bit Drill-Bits + Countersink-Bit

TIN = Mit Titan-Nitrid Beschichtung
 TIN = With titanium-nitride coating

		
Spibo-Bits Ø 3,0 4,0 4,5 5,0 6,0 8,0 10,0 + Senk-Bit Ø 10,4 + Adapter		
		50906





Spiralbohrer-Bits + Senk-Bit Drill-Bits + Countersink-Bit

		
Spibo-Bits Ø 2,5 3,3 4,2 5,0 6,0 6,8 8,5 10,2 + Senk-Bit Ø 10,4 + Adapter		
		50907



Spiralbohrer-Bits + Einschnittgewindebohrer-Bit Drill-Bits + Threading-Bit

		
Spibo-Bits Ø 3,3 4,2 5,0 6,5 + EB-Bits M 4 M 5 M 6 M 8 + Adapter		
		50908



FRÄSSTIFTE ROTARY BURRS

EXACT®

Hartmetall Frässtifte

Tungsten carbide rotary burrs

■ Produktinformation HM / HM TiCN / HM ALU	228
■ Produktinformation Formen	229

Formen und Ausführungen

Shapes and types

■ Form A	230
■ Form B	230
■ Form C	231
■ Form D	231
■ Form E	232
■ Form F	232
■ Form G	233
■ Form H	233
■ Form J	234
■ Form K	234
■ Form L	235
■ Form M	235
■ Form N	236
■ Form M + N (Multifunktion)	236

Sets

Sets

■ HM	237
■ HM TiCN	237
■ HM ALU	237

Sortiment

237

Assortment



Hartmetall Frässtifte | Tungsten carbide rotary burrs

HM		<p>Technische Information</p> <ul style="list-style-type: none"> • aus Hochleistungshartmetall • mit Kreuzverzahnung 	<p>Technical Information</p> <ul style="list-style-type: none"> • high-performance tungsten carbide • with cross toothing
		<p>Vorteile</p> <ul style="list-style-type: none"> • höhere Spanleistung gegenüber der Einfachverzahnung – wirkt sich positiv aus bei schwer zerspanbaren Werkstoffen <p>Anwendung</p> <p>Zum Entgraten, Kantenbrechen, Verputzen, zur Schweißnaht- und Flächenbearbeitung</p> <p>Einsatzgebiete</p> <p>Für hochlegierte, rost-, säure- und hitzebeständige Stähle, Guss und Kunststoffe</p>	<p>Application</p> <p>To deburr, break edges, trim, process welding seams and surface processing</p> <p>Fields of application</p> <p>For high-alloy steels, non-rusting steels, acid-resistant steels, heat-resistant steels, die-casts and plastics</p>

Hartmetall Frässtifte TiCN | Tungsten carbide rotary burrs TiCN

HM TiCN		<p>Technische Information</p> <ul style="list-style-type: none"> • aus Hochleistungshartmetall • mit Kreuzverzahnung 	<p>Einsatzgebiete</p> <p>Für hochlegierte, rost-, säure- und hitzebeständige Stähle, Guss und Kunststoffe</p>
		<p>Vorteile</p> <ul style="list-style-type: none"> • höhere Spanleistung gegenüber Einfachverzahnung, wirkt positiv bei schwer zerspanbaren Werkstoffen • zusätzliche TiCN-Oberflächenbeschichtung erhöht die Härte des Werkzeuges auf ca. 3.000 HV/Mikrohärte und die Wärmebeständigkeit bis auf 400 ° C • Höhere Standzeit <p>Anwendung</p> <p>Zum Entgraten, Kantenbrechen, Verputzen, zur Schweißnaht- und Flächenbearbeitung</p>	<p>Technical Information</p> <ul style="list-style-type: none"> • high-performance tungsten carbide • with cross toothing <p>Application</p> <p>To deburr, break edges, trim, process welding seams and surface processing</p> <p>Fields of application</p> <p>For high-alloy steels, non-rusting steels, acid-resistant steels, heat-resistant steels, die-casts and plastics</p>

Hartmetall Frässtifte ALU | Tungsten carbide rotary burrs ALU













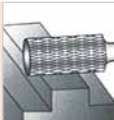

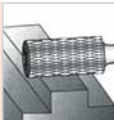











HM ALU		<p>Technische Information</p> <ul style="list-style-type: none"> • aus Hochleistungshartmetall • mit Alu-Verzahnung 	<p>Technical Information</p> <ul style="list-style-type: none"> • high-performance tungsten carbide • with aluminium toothing
		<p>Anwendung</p> <p>Zum Entgraten, Kantenbrechen, Verputzen, und zur Flächenbearbeitung</p> <p>Einsatzgebiete</p> <p>Für NE-Metalle, Alu, Messing, Kupfer, Zink, Guss und Kunststoffe</p>	<p>Application</p> <p>To deburr, break edges, trim and surface processing</p> <p>Fields of application</p> <p>For non-ferrous metals, aluminium, brass, copper, zinc, die-casts and plastics</p>

Drehzahltable | Speed Guide

Kopf Ø in mm Burr Head Diameter	Maximale Drehzahl Max. Operation Speeds	Aluminium / Plastik Aluminium / Plastic		Messing, Kupfer, Gusseisen, Bronze Brass, Copper, Cast Iron, Bronze		Ungehärteter Stahl Unhardened Steel		Gehärteter & rostfreier Stahl Hardened- & Stainless Steels, Nimonic Alloys, Titanium	
		Schnittge- schwindigkeit Speed Range	Empfohlene Startdrehzahl Recomm. Start Point	Schnittge- schwindigkeit Speed Range	Empfohlene Startdrehzahl Recomm. Start Point	Schnittge- schwindigkeit Speed Range	Empfohlene Startdrehzahl Recomm. Start Point	Schnittge- schwindigkeit Speed Range	Empfohlene Startdrehzahl Recomm. Start Point
3 (1/8")	100	60 - 80	65	45 - 80	65	60 - 80	80	60 - 80	80
6 (1/4")	65	15 - 60	40	22 - 60	45	45 - 60	50	30 - 45	40
10 (3/8")	55	10 - 50	25	15 - 40	30	30 - 40	30	19 - 30	25
12 (1/2")	35	7 - 30	20	11 - 30	25	22 - 30	25	15 - 22	20
16 (5/8")	25	6 - 20	15	9 - 20	20	18 - 20	20	12 - 18	15
20 (3/4")	20	5 - 17	10	8 - 17	12	15 - 17	15	10 - 15	10
25 (1")	15	4 - 13	8	6 - 13	10	10 - 13	10	7 - 11	8



Formen Hartmetall Frässtifte | Shapes of Tungsten carbide rotary burrs

		DIN 8033	Form
	 <p>Form A, Zylinder ohne Stirnverzahnung Shape A, cylinder without end toothing</p>	A	ZYA
	 <p>Form B, Zylinder mit Stirnverzahnung Shape B, cylinder with end toothing</p>	B	ZYA-S
	 <p>Form C, Walzenrund Shape C, ball nosed cylinder</p>	C	WRC
	 <p>Form D, Kugel Shape D, ball</p>	D	KUD
	 <p>Form E, Tropfen Shape E, oval</p>	E	TRE
	 <p>Form F, Rundbogen Shape F, ball nosed tree</p>	F	RBF
	 <p>Form G, Spitzbogen Shape G, pointed tree</p>	G	SPG
	 <p>Form H, Flamme Shape H, flame</p>	H	-
	 <p>Form J, Kegel 60° Shape J, countersink 60°</p>	J	KSJ
	 <p>Form K, Kegel 90° Shape K, countersink 90°</p>	K	KSK
	 <p>Form L, Rundkegel Shape L, ball nose cone</p>	L	KEL
	 <p>Form M, Spitzkegel Shape M, inverted cone</p>	M	SKM
	 <p>Form N, Winkel Shape N</p>	N	WKN



Hartmetall Frässtifte

Tungsten carbide rotary burrs

Form A ohne Stirnverzahnung | Shape A without end toothing



Für hochlegierte, rost-, säure- und hitzebeständige Stähle, Guss und Kunststoffe
For high-alloy steels, non-rusting steels, acid-resistant steels, heat-resistant steels, die-casts and plastics



Für hochlegierte, rost-, säure- und hitzebeständige Stähle, Guss und Kunststoffe
For high-alloy steels, non-rusting steels, acid-resistant steels, heat-resistant steels, die-casts and plastics

Technische Information

Verzahnung: Kreuzverzahnung

Technical Information

Cutting: Cross toothing

Anwendung

Zum Entgraten, Kantenbrechen, Verputzen, zur Schweißnaht- und Flächenbearbeitung

Application

To deburr, break edges, trim, process welding seams and surface processing

mm	mm	mm	mm	CODE	€	CODE	€
3	14	38	3	72211			
6	18	58	6	72212		72222	
8	18	60	6	72213		72223	
10	20	60	6	72214		72224	
12	25	65	6	72215		72225	
16	25	65	6	72216		72226	

Form B mit Stirnverzahnung | Shape B with end toothing



Für NE-Metalle, Alu, Messing, Kupfer, Zink, Guss und Kunststoffe
For non-ferrous metals, aluminium, brass, copper, zinc, die-casts and plastics



Für hochlegierte, rost-, säure- und hitzebeständige Stähle, Guss und Kunststoffe
For high-alloy steels, non-rusting, acid- and heat-resistant steels, die-casts and plastics



Für hochlegierte, rost-, säure- und hitzebeständige Stähle, Guss und Kunststoffe
For high-alloy steels, non-rusting, acid- and heat-resistant steels, die-casts and plastics

Technische Information

Verzahnung: Alu-Verzahnung / Kreuzverzahnung

Technical Information

Cutting: Aluminium toothing / Cross toothing

Anwendung

Zum Entgraten, Kantenbrechen, Verputzen, zur Schweißnaht- und Flächenbearbeitung

Application

To deburr, break edges, trim, process welding seams and surface processing

mm	mm	mm	mm	CODE	€	CODE	€	CODE	€
3	14	38	3			72241			
6	18	58	6	72232		72242		72252	
8	18	60	6			72243		72253	
10	20	60	6			72244		72254	
12	25	65	6	72235		72245		72255	
16	25	65	6			72246		72256	



Hartmetall Frässtifte

Tungsten carbide rotary burrs

Form C Walzenrund (WRC) | Shape C ball nosed cylinder (WRC)



Für NE-Metalle, Alu, Messing, Kupfer, Zink, Guss und Kunststoffe
For non-ferrous metals, aluminium, brass, copper, zinc, die-casts and plastics



Für hochlegierte, rost-, säure- und hitzebeständige Stähle, Guss und Kunststoffe
For high-alloy steels, non-rusting, acid- and heat-resistant steels, die-casts and plastics



Für hochlegierte, rost-, säure- und hitzebeständige Stähle, Guss und Kunststoffe
For high-alloy steels, non-rusting, acid- and heat-resistant steels, die-casts and plastics

Technische Information
Verzahnung: Alu-Verzahnung / Kreuzverzahnung

Technical Information
Cutting: Aluminium tothing / Cross tothing

Anwendung
Zum Entgraten, Kantenbrechen, Verputzen, zur Schweißnaht- und Flächenbearbeitung

Application
To deburr, break edges, trim, process welding seams and surface processing

mm	mm	mm	mm	CODE	€	CODE	€	CODE	€
3	14	38	3			72271		72282	
6	18	58	6	72262		72272		72283	
8	18	60	6			72273		72284	
10	20	60	6			72274		72285	
12	25	65	6	72265		72275		72286	
16	25	65	6			72276			

Form D Kugel (KUD) | Shape D ball (KUD)



Für NE-Metalle, Alu, Messing, Kupfer, Zink, Guss und Kunststoffe
For non-ferrous metals, aluminium, brass, copper, zinc, die-casts and plastics



Für hochlegierte, rost-, säure- und hitzebeständige Stähle, Guss und Kunststoffe
For high-alloy steels, non-rusting, acid- and heat-resistant steels, die-casts and plastics



Für hochlegierte, rost-, säure- und hitzebeständige Stähle, Guss und Kunststoffe
For high-alloy steels, non-rusting, acid- and heat-resistant steels, die-casts and plastics

Technische Information
Verzahnung: Alu-Verzahnung / Kreuzverzahnung

Technical Information
Cutting: Aluminium tothing / Cross tothing

Anwendung
Zum Entgraten, Kantenbrechen, Verputzen, zur Schweißnaht- und Flächenbearbeitung

Application
To deburr, break edges, trim, process welding seams and surface processing

mm	mm	mm	mm	CODE	€	CODE	€	CODE	€
3	2,7	38	3			72301		72312	
6	5	56	6	72292		72302		72313	
8	7	47	6			72303		72314	
10	9	49	6			72304		72315	
12	11	51	6	72295		72305		72316	
16	15	54	6			72306			



Hartmetall Frässtifte

Tungsten carbide rotary burrs

EXACT
PRÄZISIONSWERKZEUGE

Frässtifte • Rotary burrs

Form E Tropfen (TRE) | Shape E oval (TRE)



Für hochlegierte, rost-, säure- und hitzebeständige Stähle, Guss und Kunststoffe
For high-alloy steels, non-rusting, acid- and heat-resistant steels, die-casts and plastics

Für hochlegierte, rost-, säure- und hitzebeständige Stähle, Guss und Kunststoffe
For high-alloy steels, non-rusting, acid- and heat-resistant steels, die-casts and plastics

Technische Information

Verzahnung: Kreuzverzahnung

Technical Information

Cutting: Cross toothing

Anwendung

Zum Entgraten, Kantenbrechen, Verputzen, zur Schweißnaht- und Flächenbearbeitung

Application

To deburr, break edges, trim, process welding seams and surface processing

mm	mm	mm	mm	CODE	€	CODE	€
3	6	38	3	72321			
6	10	50	6	72322		72332	
8	15	60	6	72323		72333	
10	16	60	6	72324		72334	
12	22	67	6	72325		72335	
16	25	70	6	72326		72336	

Form F Rundbogen (RBF) | Shape F ball nosed tree (RBF)



Für NE-Metalle, Alu, Messing, Kupfer, Zink, Guss und Kunststoffe
For non-ferrous metals, aluminium, brass, copper, zinc, die-casts and plastics

Für hochlegierte, rost-, säure- und hitzebeständige Stähle, Guss und Kunststoffe
For high-alloy steels, non-rusting, acid- and heat-resistant steels, die-casts and plastics

Für hochlegierte, rost-, säure- und hitzebeständige Stähle, Guss und Kunststoffe
For high-alloy steels, non-rusting, acid- and heat-resistant steels, die-casts and plastics

Technische Information

Verzahnung: Alu-Verzahnung / Kreuzverzahnung

Technical Information

Cutting: Aluminium toothing / Cross toothing

Anwendung

Zum Entgraten, Kantenbrechen, Verputzen, zur Schweißnaht- und Flächenbearbeitung

Application

To deburr, break edges, trim, process welding seams and surface processing

mm	mm	mm	mm	CODE	€	CODE	€	CODE	€
3	13	38	3			72351			
6	18	58	6	72342		72352		72362	
8	18	60	6			72353		72363	
10	20	60	6			72354		72364	
12	25	65	6	72345		72355		72365	
16	25	70	6			72356		72366	



Hartmetall Frässtifte

Tungsten carbide rotary burrs

Form G Spitzbogen (SPG) | Shape G pointed tree (SPG)



Für NE-Metalle, Alu, Messing, Kupfer, Zink, Guss und Kunststoffe
For non-ferrous metals, aluminium, brass, copper, zinc, die-casts and plastics



Für hochlegierte, rost-, säure- und hitzebeständige Stähle, Guss und Kunststoffe
For high-alloy steels, non-rusting, acid- and heat-resistant steels, die-casts and plastics



Für hochlegierte, rost-, säure- und hitzebeständige Stähle, Guss und Kunststoffe
For high-alloy steels, non-rusting, acid- and heat-resistant steels, die-casts and plastics

Technische Information

Verzahnung: Alu-Verzahnung / Kreuzverzahnung

Technical Information

Cutting: Aluminium tothing / Cross tothing

Anwendung

Zum Entgraten, Kantenbrechen, Verputzen, zur Schweißnaht- und Flächenbearbeitung

Application

To deburr, break edges, trim, process welding seams and surface processing

mm	mm	mm	mm	CODE	€	CODE	€	CODE	€
3	13	38	3			72381			
6	18	58	6	72372		72382		72392	
8	18	60	6			72383		72393	
10	20	60	6			72384		72394	
12	25	65	6	72375		72385		72395	
16	25	70	6			72386		72396	

Form H Flamme | Shape H flame



Für hochlegierte, rost-, säure- und hitzebeständige Stähle, Guss und Kunststoffe
For high-alloy steels, non-rusting, acid- and heat-resistant steels, die-casts and plastics



Für hochlegierte, rost-, säure- und hitzebeständige Stähle, Guss und Kunststoffe
For high-alloy steels, non-rusting, acid- and heat-resistant steels, die-casts and plastics

Technische Information

Verzahnung: Kreuzverzahnung

Technical Information

Cutting: Cross tothing

Anwendung

Zum Entgraten, Kantenbrechen, Verputzen, zur Schweißnaht- und Flächenbearbeitung

Application

To deburr, break edges, trim, process welding seams and surface processing

mm	mm	mm	mm	CODE	€	CODE	€
3	6	38	3	72401			
6	14	50	6	72402		72412	
8	20	65	6	72403		72413	
10	20	65	6	72404		72414	
12	32	77	6	72405		72415	
16	36	82	6	72406		72416	



Hartmetall Frässtifte Tungsten carbide rotary burrs

EXACT
PRÄZISIONSWERKZEUGE

Form J Kegel 60° (KSJ) | Shape K countersink 60° (KSJ)



HM

Für hochlegierte, rost-, säure- und hitzebeständige Stähle,
Guss und Kunststoffe
For high-alloy steels, non-rusting, acid- and heat-resistant steels,
die-casts and plastics

**HM
TiCN**

Für hochlegierte, rost-, säure- und hitzebeständige Stähle,
Guss und Kunststoffe
For high-alloy steels, non-rusting, acid- and heat-resistant steels,
die-casts and plastics

Technische Information

Verzahnung: Kreuzverzahnung

Technical Information

Cutting: Cross tothing

Anwendung

Zum Entgraten, Kantenbrechen, Verputzen, zur Schweißnaht- und Flächenbearbeitung

Application

To deburr, break edges, trim, process welding seams and surface processing

mm	mm	mm	mm	CODE	€	CODE	€
3	3	38	3	72421			
6	6	50	6	72422		72432	
10	8	56	6	72423		72433	
12	11	60	6	72424		72434	
16	14,5	62	6	72425		72435	

Form K Kegel 90° (KSK) | Shape K countersink 90° (KSK)

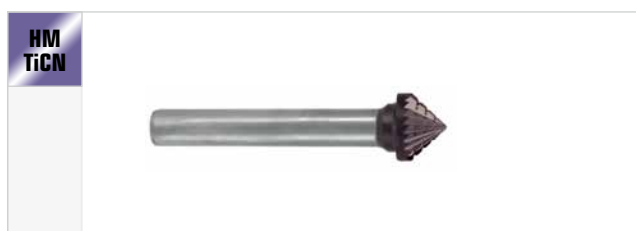

HM

Für hochlegierte, rost-, säure- und hitzebeständige Stähle,
Guss und Kunststoffe
For high-alloy steels, non-rusting, acid- and heat-resistant steels,
die-casts and plastics

**HM
TiCN**

Für hochlegierte, rost-, säure- und hitzebeständige Stähle,
Guss und Kunststoffe
For high-alloy steels, non-rusting, acid- and heat-resistant steels,
die-casts and plastics

Technische Information

Verzahnung: Kreuzverzahnung

Technical Information

Cutting: Cross tothing

Anwendung

Zum Entgraten, Kantenbrechen, Verputzen, zur Schweißnaht- und Flächenbearbeitung

Application

To deburr, break edges, trim, process welding seams and surface processing

mm	mm	mm	mm	CODE	€	CODE	€
3	3	38	3	72441			
6	3	50	6	72442		72452	
10	5	53	6	72443		72453	
12	7	55	6	72444		72454	
16	8	57	6	72445		72455	



Hartmetall Frässtifte

Tungsten carbide rotary burrs

Form L Rundkegel (KEL) | Shape L inverted cone (KEL)



Für NE-Metalle, Alu, Messing, Kupfer, Zink, Guss und Kunststoffe
For non-ferrous metals, aluminium, brass, copper, zinc, die-casts and plastics



Für hochlegierte, rost-, säure- und hitzebeständige Stähle, Guss und Kunststoffe
For high-alloy steels, non-rusting, acid- and heat-resistant steels, die-casts and plastics



Für hochlegierte, rost-, säure- und hitzebeständige Stähle, Guss und Kunststoffe
For high-alloy steels, non-rusting, acid- and heat-resistant steels, die-casts and plastics

Technische Information
 Verzahnung: Alu-Verzahnung / Kreuzverzahnung

Technical Information
 Cutting: Aluminium tothing / Cross tothing

Anwendung
 Zum Entgraten, Kantenbrechen, Verputzen, zur Schweißnaht- und Flächenbearbeitung

Application
 To deburr, break edges, trim, process welding seams and surface processing

mm	mm	mm	mm	CODE	€	CODE	€	CODE	€
3	14	38	3			72471			
6	18	50	6	72462		72472		72482	
8	25	70	6			72473		72483	
10	20	65	6	72464		72474		72484	
12	32	77	6	72465		72475		72485	
16	33	78	6	72466		72476		72486	

Form M Spitzkegel (SKM) | Shape M cone (SKM)



Für hochlegierte, rost-, säure- und hitzebeständige Stähle, Guss und Kunststoffe
For high-alloy steels, non-rusting, acid- and heat-resistant steels, die-casts and plastics



Für hochlegierte, rost-, säure- und hitzebeständige Stähle, Guss und Kunststoffe
For high-alloy steels, non-rusting, acid- and heat-resistant steels, die-casts and plastics

Technische Information
 Verzahnung: Kreuzverzahnung

Technical Information
 Cutting: Cross tothing

Anwendung
 Zum Entgraten, Kantenbrechen, Verputzen, zur Schweißnaht- und Flächenbearbeitung

Application
 To deburr, break edges, trim, process welding seams and surface processing

mm	mm	mm	mm	CODE	€	CODE	€
3	11	38	3	72491			
6	18	58	6	72492		72502	
8	18	60	6	72493		72503	
10	20	60	6	72494		72504	
12	25	65	6	72495		72505	
16	25	70	6	72496		72506	



Hartmetall Frässtifte Tungsten carbide rotary burrs

EXACT
PRÄZISIONSWERKZEUGE

Frässtifte • Rotary burrs

Form N Winkel (WKN) | Shape N (WKN)



Für hochlegierte, rost-, säure- und hitzebeständige Stähle, Guss und Kunststoffe
For high-alloy steels, non-rusting, acid- and heat-resistant steels, die-casts and plastics

Für hochlegierte, rost-, säure- und hitzebeständige Stähle, Guss und Kunststoffe
For high-alloy steels, non-rusting, acid- and heat-resistant steels, die-casts and plastics

Technische Information

Verzahnung: Kreuzverzahnung

Technical Information

Cutting: Cross toothing

Anwendung

Zum Entgraten, Kantenbrechen, Verputzen, zur Schweißnaht- und Flächenbearbeitung

Application

To deburr, break edges, trim, process welding seams and surface processing

mm	mm	mm	mm	CODE	€	CODE	€
3	5	38	3	72511			
6	8	50	6	72512		72522	
10	10	55	6	72513		72523	
12	13	58	6	72514		72524	
16	19	64	6	72515		72525	

Form M + N Multifunktion | Shape M + N multifunction



Multifunktions-Frässtift für Titan, Bronze, Edelstahl, Guss und Messing
Multifunction rotary burr for titanium, bronze, stainless steel, casting, brass

Anwendung

Optimal zum Bearbeiten von Kanten – Innovative Form verhindert das Abrutschen vom Werkstück!

Application

For optimum processing of edges – the innovative form prevent parts from slipping.

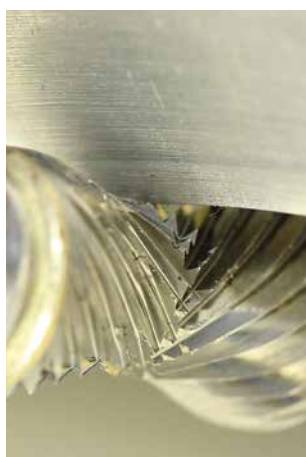

mm	mm	mm	mm	CODE	€
12,8	25	70	6	72531	





Hartmetall Frässtifte

Tungsten carbide rotary burrs

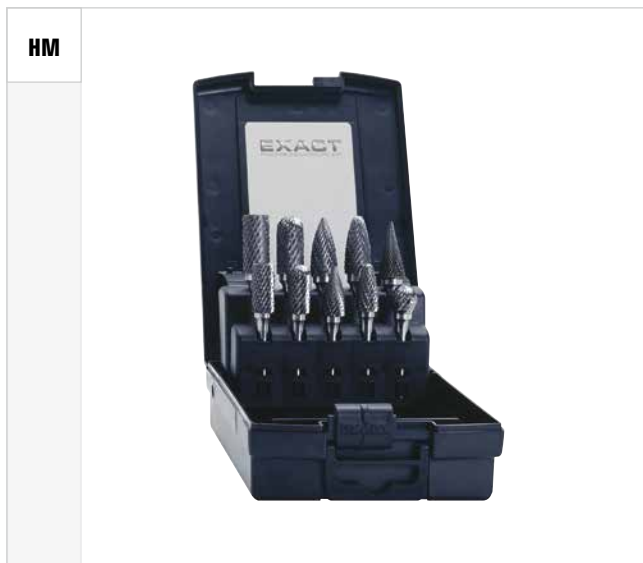
Sets | Sets





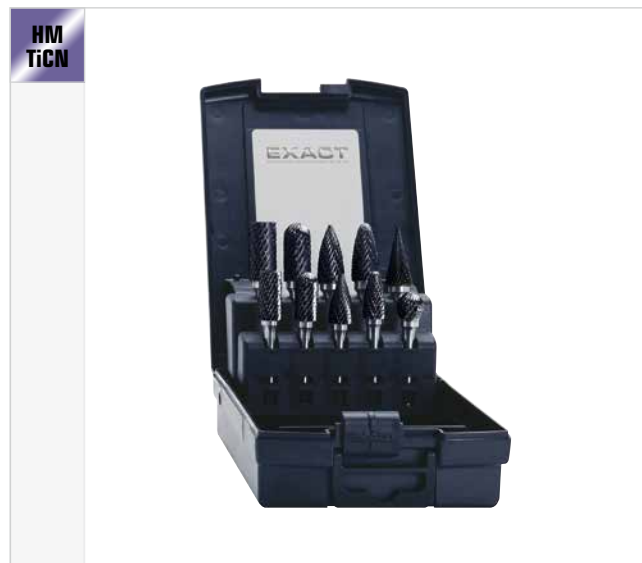

		
10-teilig – je Form 1 x Ø 10 mm + 1 x Ø 12 mm: 2 x Form A, Zylinder (ZYA) ohne Stirnverzahnung 2 x Form C, Walzenrund (WRC) 2 x Form G, Spitzbogen (SPG) 2 x Form F, Rundbogen (RBF) + 1 x Form D, Kugel (KUD) Ø 12 mm + 1 x Form M, Spitzkegel (SKM) Ø 12 mm	72202	

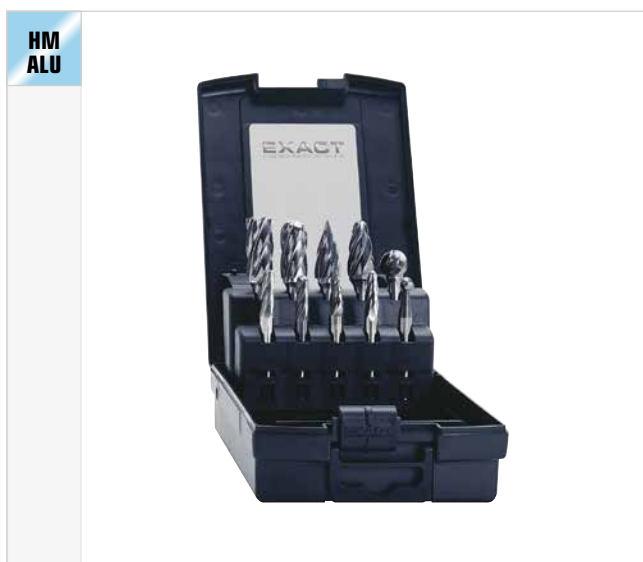

		
10-teilig – je Form 1 x Ø 10 mm + 1 x Ø 12 mm: 2 x Form A, Zylinder (ZYA) ohne Stirnverzahnung 2 x Form C, Walzenrund (WRC) 2 x Form G, Spitzbogen (SPG) 2 x Form F, Rundbogen (RBF) + 1 x Form D, Kugel (KUD) Ø 12 mm + 1 x Form M, Spitzkegel (SKM) Ø 12 mm	72203	



Sets | Sets



		
10-teilig – je Form 1 x Ø 6 mm + 1 x Ø 12 mm: 2 x Form A, Zylinder (ZYA) mit Stirnverzahnung 2 x Form C, Walzenrund (WRC) 2 x Form G, Spitzbogen (SPG) 2 x Form F, Rundbogen (RBF) 2 x Form D, Kugel (KUD)	72201	

Display | Display



		
40-teilig – je Form 2 x Ø 6 + 8 + 10 + 12 mm: 8 x Form A, Zylinder (ZYA) mit Stirnverzahnung 8 x Form C, Walzenrund (WRC) 8 x Form G, Spitzbogen (SPG) 8 x Form F, Rundbogen (RBF) 8 x Form L, Rundkegel (KEL)	73001	SET

PROFIGRAT®

Professional Finishing Deburring-System





HANDENTGRATER

HAND DEBURRING TOOLS

EXACT®

Kombinationen Handgriffe / Klingen

Combinations Handles / Blades

- Information **240**

Klingen

Blades

- 2,6 mm / HSS / Typ P **241**
- 3,2 mm / HSS / Typ C **241**
- 3,2 mm / HSS-E / Typ C **241**
- 6,0 mm / HSS / Typ R **241**

Handgriffe und Halter

Handles and Holder

- Ergonomische Handgriffe Typ T, D, R **242**
- Teleskophalter Typ DTC, DTP **242**

Entgrat-Sets

Deburring Sets

- Handgriffe und Klingen im Set **243**

Starter-Kits

Starter-Kits

- Allroundset **244**
- Spezialset **244**

Entgratkoffer

Deburring Case

- Universalset **245**

Entgrat-Bit

Finishing Bit

- Einzel **245**
- Set **245**



Mit Handgriff Typ T | With handle type T

Im Handgriff Typ T lassen sich **alle Teleskophalter für Klingen 3,2 und 2,6 mm** aus dem PROFIGRAT® Programm, aber auch aus allen anderen bekannten Entgratsortimenten, aufnehmen. Die stufenlose Justierung des Halters mit Hilfe des Drehknopfes am Ende des Griffes ermöglicht einen optimierten Einsatz des Werkzeuges.

The handle type T can be use with **all telescopic adapters for blades with 3,2 and 2,6 mm** from the PROFIGRAT range and all other popular deburring ranges. The infinitely variable adjustment with the knob, enable the perfect operation with the tool.



Mit Handgriff Typ R | With handle type R

Im Handgriff Typ R lassen sich alle „R“-Klingen aus dem PROFIGRAT® Programm aufnehmen. Die Aufnahme ist für Klingen mit **6 mm Durchmesser** konstruiert und sichert stabile Führung auch bei extrem schweren Entgratfällen.

The handle type R can be use with all „R“ blades from the PROFIGRAT Range. The toolholder is constructed for blades **with 6 mm diameter** and secure perfect guiding for hard deburring jobs.



Mit Handgriff Typ D | With handle type D

Im Handgriff Typ D lassen sich alle „C“-Klingen aus dem PROFIGRAT® Programm, aber auch aus allen anderen bekannten Entgratsortimenten aufnehmen. Die Aufnahme ist für **Klingen mit 3,2 mm Durchmesser** konstruiert und sichert die Klinge in der Aufnahme optimal. Die Möglichkeit des zufälligen Lösens der Klinge aus der Aufnahme ist minimiert.

The handle type D can be use with all „C“ blades from the PROFIGRAT range and all other popular deburring ranges. The toolholder is constructed **for blades with 3,2 mm diameter** and secure the blade in the holder. Possibility of releasing the blade by chance is reduced.





2,6 mm - HSS - Typ P | 2,6 mm - HSS - Type P

	No.	mm	INHALT	Entgrat-Richtung Deburring direction	Stahl Steel	Alu Alu	Kupfer Zink Copper Zinc	Plastik Plastic	Messing Guss Brass Cast Iron	Edelstahl Stainless steel	CODE	€ Stück
	P-1	2,6	10	→	•	•	•	•			60081	
	P-2	2,6	10	→	○	○	○	○	•		60082	
	P-3	2,6	10	→	•	•	•	•	○		60083	
	P-1 TIN	2,6	10	→	•	•	•	•		•	60084	
	P-2 TIN	2,6	10	→	•	•	•	•	•		60085	

3,2 mm - HSS - Typ C | 3,2 mm - HSS - Type C

	C-10	3,2	10	→	•	•	•	•			60055	
	C-20	3,2	10	↔	○	○	○	○	•		60056	
	C-30	3,2	10	→	•	•	•	•	○		60059	
	C-15	3,2	10	↔				•		•	60060	
	C-35	3,2	10	→	•	•	•	•	○	○	60071	
	C-101	3,2	10	→	•	•	•	•	○	○	60061	
	C-10 TIN	3,2	10	→	•	•	•	•		•	60057	
	C-20 TIN	3,2	10	↔	•	•	•	•	•		60058	

3,2 mm - HSS-E - Typ C | 3,2 mm - HSS-E - Type C

	C-100	3,2	10	→	•	•	•	•		•	60069	
	C-150	3,2	10	↔	•	•	•	•	○	•	60070	

6 mm - HSS - Typ R | 6 mm - HSS - Type R

	R-10	6,0	5	→	•	•	•	•	○		60086	
	R-15	6,0	5	↔					○	•	60087	





Handgriffe & Halter Handles & Holder

Ergonomische Handgriffe | Ergonomic handles

	No.	mm	CODE	€
 Zur Aufnahme von Teleskoplatern DTC + DTP	T	23	60023	
 Zur Aufnahme von 3,2 mm Klingen	D	23	60021	
 Zur Aufnahme von 6 mm Klingen	R	23	60031	

Teleskophalter | Telescopic holders





















 Zur Aufnahme von 3,2 mm Klingen (Typ C)	DTC	7	60072	
 Zur Aufnahme von 2,6 mm Klingen (Typ P)	DTP	7	60076	



Entgrater-Sets Deburring Sets

EXACT
PRÄZISIONSWERKZEUGE

Handgriffe & Klingen im Set | Sets of handles & blades

No.	INHALT	CODE	€ SET
DT1/10  Einweg-Klingen	Set à 10 Stk. 	60043	
DT2/5  Klingen auswechselbar	Set à 5 Stk. 3,2 mm Klinge 	60044	
DT3  Mit 3,2 mm Klingen	Handgriff D  C-10 C-20 C-35  1 x 1 x 1 x	60005	
SCR-8  Klinge auswechselbar		60017	
DT5  Mit 3,2 mm Klingen	Handgriff T  C-10 C-20 C-30 C-15 C-35  1 x 1 x 1 x 1 x 1 x Teleskopadapter DTC	60008	
KWS  		60013	
SDT  		60014	
DT-SD Universalantgrater   Mit 3,2 + 2,6 + 6 mm Klingen	 R-15 C-10 C-20 C-30  SD-C SD-P P-1 P-2 P-3	60003	

Profigrat®

Starter-Kit 3 | Starter-Kit 3



Anwendung

PROFIGRAT® Starter-Kit 3 ist ein „Allroundset“ und für alle Entgratarbeiten geeignet. Es enthält die gängigen Klingengrößen 2,6 mm und 3,2 mm in unterschiedlichen Ausführungen zur Bearbeitung unterschiedlichster Materialien sowie entsprechende Handgriffe und Teleskophalter zur Aufnahme.

Application

PROFIGRAT® Starter Kit 3 is an “all-rounder kit” and suitable for all deburring work. It contains common conventional blade sizes of 2.6 mm and 3.2 mm in various finishes for machining a wide range of materials and the appropriate handles and telescoping holders for securing them.

INHALT	CODE	€ SET
Klingen Blades je 2 x C-10 C-15 C-20 C-30 C-35 C-101 C-10 TIN P-1 P-2 P-3 Handgriffe Handles je 1 Typ T + D Teleskophalter Telescopic holders je 1 x DTC + DTP	60095	

Starter-Kit 5 | Starter-Kit 5



Anwendung

PROFIGRAT® Starter-Kit 5 ist ein „Spezialset“ zur Bearbeitung unterschiedlichster Materialien für besonders harte Entgratfälle!

Das Set enthält Klingen aus 6 mm HSS Stahl in zwei Ausführungen mit entsprechendem Handgriff sowie einen Schaber mit auswechselbarer 8 mm Klinge zur flächigen Bearbeitung.

Application

PROFIGRAT® Starter Kit 5 is a “special kit” for machining a wide range of materials for particularly difficult deburring tasks.

The kit contains blades made of 6 mm HSS in two finishes with the appropriate handle and a scraper with replaceable 8 mm blade for machining surfaces

INHALT	CODE	€ SET
Klingen Blades je 5 x R-10 + R-15 Handgriffe Handles 1 x Typ D Schaber SCR-8	60096	



Universal-Entgratkoffer Universal Deburring Case

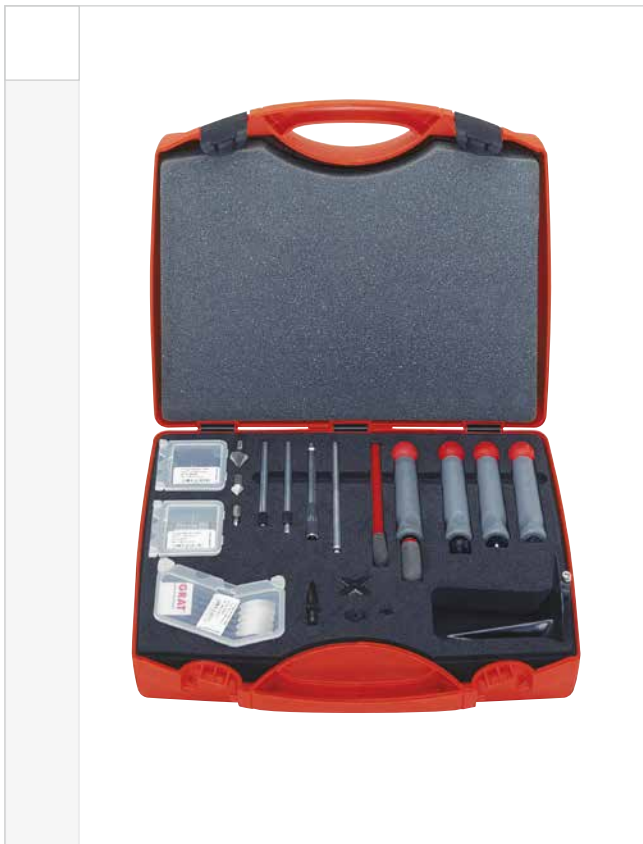

Anwendung

Der PROFIGRAT® Universal-Entgratkoffer ist für alle Entgratarbeiten geeignet. Er enthält alle gängigen Klingengrößen 2,6 mm, 3,2 mm und 6,0 mm sowie Spezialklingen und Schaber zur Bearbeitung unterschiedlichster Materialien. Ebenso alle passenden Handgriffe und Teleskophalter zur Aufnahme.

Application

The PROFIGRAT® Universal Deburring Case is suitable for all deburring work. It contains all conventional blade sizes of 2.6 mm, 3.2 mm and 6.0 mm, special blades and scrapers for machining a wide range of materials. And the appropriate handles and telescoping holders for securing them.

INHALT	CODE	€ SET
Handgriffe Handles je 1 x Typ T / D / R Teleskophalter Telescopic holders je 1 x DTC / DTP / SBT / VT Handschutz Handguard 1 x Schaber Scraper je 1 x SCR-8 (grob) / SCR-3 (fein) Ersatzklinge für SCR-8 Blade for SCR-8 1 x Klingen 2,6 mm Blades 2,6 mm 10 x P-1 Klingen 3,2 mm Blades 3,2 mm 10 x C-10 Klingen 6,0 mm Blades 6,0 mm 5 x R-10 Doppel-Entgratklinge Double deburring blade 1 x V-4 Keilnuten-Entgratklinge Key way deburring blades je 1 x KW9 / KW16 Entgratsenker Deburring Countersink je 1 x 6,3 mm / 10,4 mm / 16,5 mm	60099	

Entgrat-Bit | Finishing-Bit



Technische Information

Mit 1/4" Bitschaft Antrieb (DIN 3126) • passend für alle 1/4" Bit-Halter

Anwendung

Spezial-Bit (Klinge B12) zum mühelosen Entgraten von Bohrungen, Nuten und Kanten an Metallen und Kunststoffen.

Technical Information

With 1/4 Inch drill shaft (DIN 3126)

Application

Finishing-Bit removes burrs, cleans grooves and edges in a professional manner.

	VE	CODE	€ Stück
25	5	60094	



INHALT	CODE	€ SET
Komfortabler 2-Komponenten-Halter zur Aufnahme handelsüblicher Bits mit 1/4" Bitschaft + 2 Spezial-Bits zum Entgraten	60097	



LOCHSÄGEN HOLE SAWS

EXACT®

Bi-Metall Lochsägen

Bi-metal Hole Saws

■ Produktinformation	248
■ HSS / HSS-Co8 Bi-Metall	248
■ Lochsägensets HSS / HSS-Co8 Bi-Metall	249

Bi-Metall Lochsägen Zubehör

Bi-metal Hole Saws Accessories

■ Aufnahmewerkzeuge	251
■ Führungsbohrer	251
■ Verlängerungen	251
■ Auswurffeder	251

Hartmetall Lochsägen

Tungsten Carbide Hole Saws

■ für VA und Edelstahl	250
------------------------	-----

Hartmetall Lochsägen Zubehör

Tungsten Carbide Hole Saws Accessories

■ Ersatzführungsbohrer	251
------------------------	-----



Bi-Metall Lochsägen

Bi-metal Hole Saw

EVENTUS[®]
by EXACT

Lochsägen • Hole Saw

Bi-Metall | Bi-metal



Produktinfo | Productinformation

Vorteile

- Die variable Verzahnung sorgt bei leicht zerspanbaren Materialien für einen gleichmäßigen Schnitt bei nur geringem Kraftaufwand.
- Geringe Vibration und Wärmeentwicklung beim Schneiden erhöhen die Standzeit bis auf das 3-fache!

Eigenschaften

- Schneller Zusammenbau und Wechsel von Lochsägendurchmesser da System 2-teilig: Schaft + Lochsäge
- Auswechselbarer Zentrierbohrer
- Hohe Rundlaufgenauigkeit / Optimale Spanabfuhr
- Positiver Span- und Schnittwinkel sorgen für aggressiven Schnitt
- Seitliche Schlitz im Körper dienen zum einfachen Entnehmen der ausgeschnittenen Teile

Materialbearbeitung

HSS: Geeignet für unlegierte Stähle bis 700 N/mm², Bunt- und Leichtmetalle, Kunststoff und Holzverarbeitung

HSS-Co8: Zusätzlich speziell für Edelstahl / VA und hochfeste Materialien

Anwendungshinweise

Geeignet für Hand- und Säulenbohrmaschinen (bei letzterem bitte manuelle Vorschub verwenden). Nicht für den Schlagbohrbetrieb geeignet. Mit leichtem und gleichmäßigem Anpreßdruck bohren. Drehzahl-tabelle beachten. Kühlmittel verwenden.

Technische Information

HSS = Hochleistungsschnell-Stahl

HSS-Co8 = Hochleistungsschnell-Stahl Klasse E

Mit variabler Zahnteilung. Bauhöhe 40 - 45 mm

Technical Information

HSS = High-speed-steel

HSS-Co8 = High-speed-steel E-class

With variable tooth patterns. Cutting depth 40 - 45 mm

mm	Zoll	CODE HSS	NEU CODE HSS-Co8
14	9/16	06001	06601
16	5/8	06002	06602
17		06003	06603
19	3/4	06004	06604
20		06005	06605
21		06006	06606
22	7/8	06007	06607
24	15/16	06008	06608
25	1	06009	06609
27	1 1/16	06010	06610
29	1 1/8	06011	06611
30	1 3/16	06012	06612
32	1 1/4	06013	06613
33		06014	06614
35	1 3/8	06015	06615
37		06016	06616
38	1 1/2	06017	06617
40		06018	06618
41	1 5/8	06019	06619
43	1 11/16	06020	06620
44	1 3/4	06021	06621
45		06022	06622
46	1 13/16	06023	06623
48	1 7/8	06024	06624
50		06025	06625
51	2	06026	06626
52		06027	06627
54	2 1/8	06028	06628
55		06029	06629
57	2 1/4	06030	06630

mm	Zoll	CODE HSS	NEU CODE HSS-Co8
59		06031	06631
60	2 3/8	06032	06632
64	2 1/2	06033	06633
65		06034	06634
67	2 5/8	06035	06635
68		06036	06636
68,5		06037	06637
70	2 3/4	06038	06638
73	2 7/8	06039	06639
75		06040	06640
76	3	06041	06641
79	3 1/8	06042	06642
83	3 1/4	06043	06643
86	3 3/8	06044	06644
89	3 1/2	06045	06645
92	3 5/8	06046	06646
95	3 3/4	06047	06647
98	3 7/8	06048	06648
100		06049	06649
102	4	06050	06650
105		06051	06651
108	4 1/4	06052	06652
111	4 3/8	06053	06653
114	4 1/2	06054	06654
121	4 3/4	06055	06655
127	5	06056	06656
140	5 1/2	06057	06657
146		06058	06658
152	6	06059	06659



Bi-Metall Lochsägen Bi-metal Hole Saw

EVENTUS[®]
by EXACT

Bi-Metall Lochsägen-Sortimente | Bi-metal Hole Saws Assortments



Lochsägen • Hole Saw

SET	INHALT	CODE HSS	NEU CODE HSS-Co8
Universal-Sortiment Universal	je 1 x 22 / 25 / 27 / 29 / 38 mm je 1 Aufnahme Nr. 3 + 5	06081	06681
Elektriker-Sortiment 1 Electrician 1	je 1 x 22 / 29 / 35 / 44 / 51 / 64 mm je 1 Aufnahme Nr. 3 + 5	06082	06682
Elektriker-Sortiment 2 Electrician 2	je 1 x 22 / 29 / 35 / 44 / 51 / 57 / 64 / 68 mm je 1 Aufnahme Nr. 3 + 5	06100	06700
Sanitär Sortiment 1 Sanitary 1	je 1 x 19 / 22 / 29 / 38 / 44 / 57 mm je 1 Aufnahme Nr. 3 + 5	06083	06683
Sanitär Sortiment 2 Sanitary 2	je 1 x 20 / 25 / 30 / 50 / 68 mm je 1 Aufnahme Nr. 2 + 5	06084	06684
General-Sortiment 1 General 1	je 1 x 19 / 22 / 25 / 29 / 35 / 38 / 44 / 51 / 57 / 64 mm je 1 Aufnahme Nr. 3 + 5	06087	06687
General-Sortiment 2 General 2	je 1 x 20 / 25 / 30 / 35 / 40 / 45 / 50 / 68 / 75 / 83 mm je 1 Aufnahme Nr. 2 + 5	06085	06685



Hartmetall Lochsägen Tungsten Carbide Hole Saw

EXACT
PRÄZISIONSWERKZEUGE

Hart-Metall | Tungsten Carbide Holesaws



Technische Information





Flachschnitt, 12 mm Bauhöhe





Bis 2 mm für VA und Edelstahl • bis 4 mm für Baustahl

Technical Information

Flat cut, 12 mm depth

2 mm for stainless steel • 4 mm for normal steel

			
15,2	10	06101	
16,0	10	06102	
17,0	10	06103	
18,0	10	06104	
18,6	10	06105	
19,0	10	06106	
20,0	10	06107	
20,4	10	06108	
21,0	10	06109	
22,0	10	06110	
22,5	10	06111	
23,0	10	06112	
24,0	10	06113	
25,0	10	06114	
26,0	10	06115	
27,0	10	06116	
28,0	10	06117	
28,3	10	06118	
29,0	10	06119	
30,0	10	06120	
31,0	10	06121	
32,0	10	06122	
33,0	10	06123	
34,0	10	06124	
35,0	10	06125	
36,0	10	06126	
37,0	10	06127	
38,0	10	06128	
39,0	10	06129	
40,0	10	06130	
41,0	10	06131	
42,0	10	06132	
43,0	10	06133	
44,0	10	06134	
45,0	10	06135	
46,0	10	06136	
47,0	10	06137	
48,0	10	06138	
49,0	10	06139	
50,0	10	06140	
51,0	13	06141	
52,0	13	06142	
53,0	13	06143	
54,0	13	06144	
55,0	13	06145	
56,0	13	06146	
57,0	13	06147	
58,0	13	06148	
59,0	13	06149	
60,0	13	06150	

			
61,0	13	06151	
62,0	13	06152	
63,0	13	06153	
64,0	13	06154	
65,0	13	06155	
66,0	13	06156	
67,0	13	06157	
68,0	13	06158	
69,0	13	06159	
70,0	13	06160	
71,0	13	06161	
72,0	13	06162	
73,0	13	06163	
74,0	13	06164	
75,0	13	06165	
76,0	13	06166	
77,0	13	06167	
78,0	13	06168	
79,0	13	06169	
80,0	13	06170	
81,0	13	06171	
82,0	13	06172	
83,0	13	06173	
84,0	13	06174	
85,0	13	06175	
86,0	13	06176	
87,0	13	06177	
88,0	13	06178	
89,0	13	06179	
90,0	13	06180	
91,0	13	06181	
92,0	13	06182	
93,0	13	06183	
94,0	13	06184	
95,0	13	06185	
96,0	13	06186	
97,0	13	06187	
98,0	13	06188	
99,0	13	06189	
100,0	13	06190	
105,0	13	06191	
110,0	13	06192	
115,0	13	06193	
120,0	13	06194	
125,0	13	06195	
130,0	13	06196	
135,0	13	06197	
140,0	13	06198	
145,0	13	06199	
150,0	13	06200	



Zubehör Lochsägen Hole Saws Accessories

Ersatzführungsbohrer | Pilot Drill



No.	mm	CODE	€
25	HSS, 6 mm (bis Ø 100 mm)	06391	
26	HSS, 8 mm (bis Ø 105 mm)	06392	

Technische Information

HSS = Hochleistungsschnell-Stahl

Anwendung

Ersatzführungsbohrer für Hartmetall Lochsägen

Technical Information

HSS = High-speed-steel

Application

Pilot drills for Tungsten Carbide Hole Saw

Aufnahmewerkzeug & Führungsbohrer | Hole Saw Arbors & Pilot Drill



Anwendung

Aufnahmewerkzeuge mit Führungsbohrer für Bi-Metall Lochsägen

Application

Hole Saws Arbors with guide drills and pilot drills for Bi-metal Hole Saw

No.	mm	mm	mm	CODE	NEU
					CODE
1	14 - 30	6,4		06091	06691
2	14 - 30		9,5	06092	06692
3	14 - 30		11,0	06093	06693
4	32 - 152		16,0	06094	06694
5	32 - 152		11,0	06095	06695
7	14 - 30	SDS		06089	06689
8	32 - 152	SDS		06090	06690

mm	No.	mm	CODE	NEU
				CODE
6,35	Nr. 1 / 4	115	06097	06697
6,35	Nr. 2 / 3 / 4 / 5	70	06098	06698

Verlängerung & Auswurffeder | Extension & Spring



Anwendung

300 mm • Für Bi-Metall Lochsägen Aufnahmewerkzeuge Nr. 3 + 5

Application

300 mm • For Bi-metal Holesaws Arbors No. 3 + 5

No.	mm	CODE	€
20	Für Aufnahmen Nr. 3 + 5	06096	

No.	CODE	€
30	06099	



SPIRALBOHRER

TWIST DRILLS

EXACT®

EVENTUS®
by EXACT

DIN 338

DIN 338

- Typ I Type N I HSS-R
- Typ I Type N I HSS-R I
reduzierter Schaft I reduced shaft
- Typ I Type N I HSS-G **256-258**
- Typ I Type N I HSS-G I VAP **256-258**
- Typ I Type N I HSS-G I TIN **256-258**
- Typ I Type N I HSS-G I TiAIN **256-258**
- Typ I Type VA I HSSE-Co 5 **259-260**
- Typ I Type VA I HSSE-Co 8 **261**
- Typ I Type N I HSS-G I TIN-TIP **262-263**
- Typ I Type N I HSS-G I TiAIN-TIP **262-263**
- Typ I Type N I HSSE-Co 5 I ROTASTOP® **264**
- Typ I Type EX-TL I HSS-G **266**
- Typ I Type EX-TL I HSSE-Co 5 **267**
- Typ I Type UNI I HSS-G **268**
- Typ I Type UNI I HSSE-Co 5 **269**
- Typ I Type N I HSS-G **270**
reduzierter Schaft I reduced shaft
- Typ I Type N I HSSE-Co 5 **271**
reduzierter Schaft I reduced shaft

292-293
294

295-297

295-297

298-299

DIN 340

DIN 340

- Typ I Type N I HSS-R
- Typ I Type N I HSS-G **272**
- Typ I Type EX-TL I HSSE-Co 5 **273**

300

DIN 345

DIN 345

- Typ I Type N I HSS-R
- Typ I Type N I HSS-G **274-275**
- Typ I Type EX-TL I HSSE-Co 5 **276**

301-302

DIN 1897

DIN 1897

- Typ I Type N I HSS-G extra kurz I extra short **277**
- Typ I Type N I HSSE-Co 5 extra kurz I extra short **278**
- Typ I Type UF-L I HSSE-Co 5 extra kurz I extra short **279**

SETS DIN 338

- Sets DIN 338** **280-285**

304-307

Zusatzartikel

- Additional products** **288-290**

303



Anwendung
EXACT
Spiralbohrer

Application
EXACT
Twist Drills

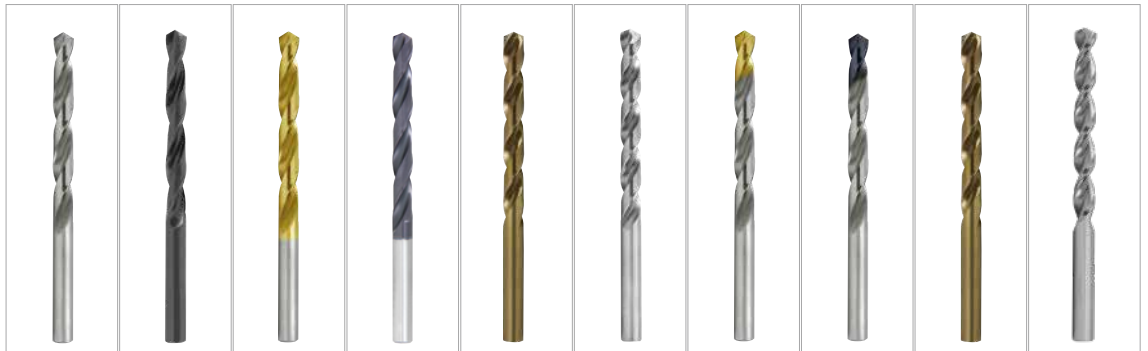













Norm Standard	DIN 338	DIN 338	DIN 338	DIN 338	DIN 338	DIN 338	DIN 338	DIN 338	DIN 338	DIN 338
Typ Type	N	N	N	N	VA	VA	N	N	N	EX-TL
Bohrtiefe Depth of drilling	5xD	5xD	5xD	5xD	5xD	5xD	5xD	5xD	5xD	5xD
Beschichtung Coating		dampfang.	TiN	TiAlN			TiN-Tip	TiAlN-Tip		
Werkstoff Steel grade	HSS-G	HSS-G	HSS-G	HSS-G	HSSE-Co 5	HSSE-Co 8	HSS-G	HSS-G	HSSE-Co 5	HSS-G
Spitzenwinkel Point angel	118°	118°	118°	118°	130°	130°	118°	118°	130°	130°
Ø mm	0,3 - 16,0	1,0 - 13,0	0,3 - 16,0	0,3 - 16,0	1,0 - 16,0	1,0 - 16,0	1,0 - 16,0	1,0 - 16,0	1,0 - 13,0	1,0 - 13,0
Seite Page	266-258	266-258	266-258	266-258	259-260	261	262-263	262-263	264	266

Geeignet für Suitable for										
Stähle < 850 N/mm ² Steels < 850 N/mm ²	●	●	●	●	●	○	●	●	●	●
Stähle < 1100 N/mm ² Steels < 1100 N/mm ²	○	○	○	○	●	●	○	○	●	○
Stähle < 1300 N/mm ² Steels < 1300 N/mm ²						●				
INOX < 850 N/mm ² Rostfreie Stähle < 850 N/mm ² Stainless steels < 850 N/mm ²	○	○	○	○	●	●	○	○	●	
INOX > 850 N/mm ² Rostfreie Stähle > 850 N/mm ² Stainless steels > 850 N/mm ²					●	●			○	
Grauguss Cast iron Grauguss, Temperguss Cast iron, malleable cast iron	●	●	●	●	○	●	○	○		○
Ti Titan- und Titanlegierungen Titanium and titanium alloys										
Cu Kupfer Copper	○	○	○	○			○	○		○
Ms Messing Brass	○	○	○	○			○	○		○
Al Aluminium Aluminium	○	○		○				○		○
Kunststoffe Plastics	○	○	○	○			○	○		○

● empfohlen | recommended ○ bedingt geeignet | partly suitable

Spiralbohrer • Twist Drills

											
DIN 338	DIN 338	DIN 338	DIN 338	DIN 338	DIN 340	DIN 340	DIN 345	DIN 345	DIN 1897	DIN 1897	DIN 1897
EX-TL	UNI	UNI	N	N	N	EX-TL	N	N	N	N	UF-L
5xD	5xD	5xD	5xD	5xD	10xD	10xD	6xD	6xD	3xD	3xD	3xD
HSSE-Co 5	HSS-G	HSSE-Co 5	HSS-G	HSSE-Co 5	HSS-G	HSSE-Co 5	HSS-G	HSSE-Co 5	HSS-G	HSSE-Co 5	HSSE-Co 5
130°	135°	135°	118°	130°	118°	130°	118°	118°	118°	130°	130°
1,0 - 16,0	1,0 - 13,0	1,0 - 13,0	10,5 - 20,0	10,5 - 20,0	2,5 - 13,0	2,5 - 13,0	10,0 - 60,0	10,0 - 30,0	2,0 - 13,0	2,0 - 13,0	2,0 - 13,0
267	268	269	270	271	272	273	274-275	276	277	278	279
●	●	●	●	●	●	●	●	●	●	●	●
●	○	●	○	●	○	●	●	●	○	●	●
○						○					○
○		○	○	●	○	○		○	○	●	●
○		○	○	●						○	○
○		○	○	○	○	○	●	○	○		○
										○	○
○		○	○		○	○	○	○	○		○
○		○	○		○	○	○	○	○		○
○		○	○		○	○		○	○		○
○		○	○		○	○		○	○		○



Spiralbohrer | Twist Drills DIN 338 | Typ N | HSS-G

HSS-G

DIN 338

N

5xD

118°

25-30°

Form C
≥∅ 2,0 mm

[Image]

HSS-G

HSS-G VAP

HSS-G TIN

HSS-G TiAlN

Leistungsstarker, geschliffener Standard-Spiralbohrer aus Hochleistungs-Schnellarbeitsstahl. Der Spiralbohrer ist komplett geschliffen und verfügt über eine präzise Rundlaufgenauigkeit. Durch den Kreuzanschliff hat dieser Bohrer eine gute Zentrierung und benötigt eine geringe Vorschubkraft. Der dampfangelassene Spiralbohrer verringert die Reibung und den Gleitwiderstand. Diese Vaporisierung hilft Kaltaufschweißungen und Aufbauschnelden zu vermeiden. Die Titan-Nitrid- und Titan-Aluminium-Nitrid-Beschichtungen erhöhen die Oberflächenhärte und die Wärmebeständigkeit und verbessern die Standzeiten bei erhöhten Schnittwerten.

High-performance ground standard twist drill made from heavy-duty high speed steel. The fully ground twist drill has a precise concentricity. Thanks to the split point, this drill has good centring properties and requires little pressure. The vaporized twist drill reduces cold-welding. The titanium nitride and titanium aluminium nitride coating will increase a longer tool life.



Sets: Seiten 280 - 281 | **Pages 280 - 281**

< 850 N/mm²
●

< 1100 N/mm²
○

< 1300 N/mm²
○

INOX
< 850 N/mm²
○

INOX
> 850 N/mm²
○

Grauguss
Cast iron
●

Ti
○

Cu
○

Ms
○

Al
○

[K icon]
○

● empfohlen | recommended ○ bedingt geeignet | partly suitable

∅	L1	L2	HSS-G		HSS-G		HSS-G		HSS-G	
			Code	Stk. pcs.	Code	Stk. pcs.	Code	Stk. pcs.	Code	Stk. pcs.
0,3	19,0	3,0	73003	10		10	73203	10	72803	10
0,4	20,0	5,0	73004	10		10	73204	10	72804	10
0,5	22,0	6,0	73005	10		10	73205	10	72805	10
0,6	24,0	7,0	73006	10		10	73206	10	72806	10
0,7	28,0	9,0	73007	10		10	73207	10	72807	10
0,8	30,0	10,0	73008	10		10	73208	10	72808	10
0,9	32,0	11,0	73009	10		10	73209	10	72809	10
1,0	34,0	12,0	73010	10	73410	10	73210	10	72810	10
1,1	36,0	14,0	73011	10		10	73211	10	72811	10
1,2	38,0	16,0	73012	10		10	73212	10	72812	10

Ø	L1	L2	HSS-G		HSS-G		HSS-G		HSS-G	
			Code	Stk. pcs.	Code	Stk. pcs.	Code	Stk. pcs.	Code	Stk. pcs.
1,3	38,0	16,0	73013	10		10	73213	10	72813	10
1,4	40,0	18,0	73014	10		10	73214	10	72814	10
1,5	40,0	18,0	73015	10	73415	10	73215	10	72815	10
1,6	43,0	20,0	73016	10		10	73216	10	72816	10
1,7	43,0	20,0	73017	10		10	73217	10	72817	10
1,8	46,0	22,0	73018	10		10	73218	10	72818	10
1,9	46,0	22,0	73019	10		10	73219	10	72819	10
2,0	49,0	24,0	73020	10	73420	10	73220	10	72820	10
2,1	49,0	24,0	73021	10		10	73221	10	72821	10
2,2	53,0	27,0	73022	10		10	73222	10	72822	10
2,3	53,0	27,0	73023	10		10	73223	10	72823	10
2,4	57,0	30,0	73024	10		10	73224	10	72824	10
2,5	57,0	30,0	73025	10	73425	10	73225	10	72825	10
2,6	57,0	30,0	73026	10		10	73226	10	72826	10
2,7	61,0	33,0	73027	10		10	73227	10	72827	10
2,8	61,0	33,0	73028	10		10	73228	10	72828	10
2,9	61,0	33,0	73029	10		10	73229	10	72829	10
3,0	61,0	33,0	73030	10	73430	10	73230	10	72830	10
3,1	65,0	36,0	73031	10		10	73231	10	72831	10
3,2	65,0	36,0	73032	10		10	73232	10	72832	10
3,3	65,0	36,0	73033	10	73433	10	73233	10	72833	10
3,4	70,0	39,0	73034	10		10	73234	10	72834	10
3,5	70,0	39,0	73035	10	73435	10	73235	10	72835	10
3,6	70,0	39,0	73036	10		10	73236	10	72836	10
3,7	70,0	39,0	73037	10		10	73237	10	72837	10
3,8	75,0	43,0	73038	10		10	73238	10	72838	10
3,9	75,0	43,0	73039	10		10	73239	10	72839	10
4,0	75,0	43,0	73040	10	73440	10	73240	10	72840	10
4,1	75,0	43,0	73041	10		10	73241	10	72841	10
4,2	75,0	43,0	73042	10	73442	10	73242	10	72842	10
4,3	80,0	47,0	73043	10		10	73243	10	72843	10
4,4	80,0	47,0	73044	10		10	73244	10	72844	10
4,5	80,0	47,0	73045	10	73445	10	73245	10	72845	10
4,6	80,0	47,0	73046	10		10	73246	10	72846	10
4,7	80,0	47,0	73047	10		10	73247	10	72847	10
4,8	86,0	52,0	73048	10		10	73248	10	72848	10
4,9	86,0	52,0	73049	10		10	73249	10	72849	10
5,0	86,0	52,0	73050	10	73450	10	73250	10	72850	10
5,1	86,0	52,0	73051	10		10	73251	10	72851	10
5,2	86,0	52,0	73052	10		10	73252	10	72852	10
5,3	86,0	52,0	73053	10		10	73253	10	72853	10
5,4	93,0	57,0	73054	10		10	73254	10	72854	10
5,5	93,0	57,0	73055	10	73455	10	73255	10	72855	10
5,6	93,0	57,0	73056	10		10	73256	10	72856	10
5,7	93,0	57,0	73057	10		10	73257	10	72857	10
5,8	93,0	57,0	73058	10		10	73258	10	72858	10
5,9	93,0	57,0	73059	10		10	73259	10	72859	10
6,0	93,0	57,0	73060	10	73460	10	73260	10	72860	10
6,1	101,0	63,0	73061	10		10	73261	10	72861	10
6,2	101,0	63,0	73062	10		10	73262	10	72862	10
6,3	101,0	63,0	73063	10		10	73263	10	72863	10
6,4	101,0	63,0	73064	10		10	73264	10	72864	10
6,5	101,0	63,0	73065	10	73465	10	73265	10	72865	10
6,6	101,0	63,0	73066	10		10	73266	10	72866	10
6,7	101,0	63,0	73067	10		10	73267	10	72867	10
6,8	109,0	69,0	73068	10	73468	10	73268	10	72868	10
6,9	109,0	69,0	73069	10		10	73269	10	72869	10
7,0	109,0	69,0	73070	10	73470	10	73270	10	72870	10
7,1	109,0	69,0	73071	10		10	73271	10	72871	10
7,2	109,0	69,0	73072	10		10	73272	10	72872	10
7,3	109,0	69,0	73073	10		10	73273	10	72873	10
7,4	109,0	69,0	73074	10		10	73274	10	72874	10
7,5	109,0	69,0	73075	10	73475	10	73275	10	72875	10
7,6	117,0	75,0	73076	10		10	73276	10	72876	10
7,7	117,0	75,0	73077	10		10	73277	10	72877	10

Fortsetzung | Continuation

Spiralbohrer | Twist Drills DIN 338 | Typ N | HSS-G

Ø	L1	L2	HSS-G		HSS-G		HSS-G		HSS-G	
			Code	Stk. pcs.	Code	Stk. pcs.	Code	Stk. pcs.	Code	Stk. pcs.
7,8	117,0	75,0	73078	10		10	73278	10	72878	10
7,9	117,0	75,0	73079	10		10	73279	10	72879	10
8,0	117,0	75,0	73080	10	73480	10	73280	10	72880	10
8,1	117,0	75,0	73081	10		10	73281	10	72881	10
8,2	117,0	75,0	73082	10		10	73282	10	72882	10
8,3	117,0	75,0	73083	10		10	73283	10	72883	10
8,4	117,0	75,0	73084	10		10	73284	10	72884	10
8,5	117,0	75,0	73085	10	73485	10	73285	10	72885	10
8,6	125,0	81,0	73086	10		10	73286	10	72886	10
8,7	125,0	81,0	73087	10		10	73287	10	72887	10
8,8	125,0	81,0	73088	10		10	73288	10	72888	10
8,9	125,0	81,0	73089	10		10	73289	10	72889	10
9,0	125,0	81,0	73090	10	73490	10	73290	10	72890	10
9,1	125,0	81,0	73091	10		10	73291	10	72891	10
9,2	125,0	81,0	73092	10		10	73292	10	72892	10
9,3	125,0	81,0	73093	10		10	73293	10	72893	10
9,4	125,0	81,0	73094	10		10	73294	10	72894	10
9,5	125,0	81,0	73095	10	73495	10	73295	10	72895	10
9,6	133,0	87,0	73096	10		10	73296	10	72896	10
9,7	133,0	87,0	73097	10		10	73297	10	72897	10
9,8	133,0	87,0	73098	10		10	73298	10	72898	10
9,9	133,0	87,0	73099	10		10	73299	10	72899	10
10,0	133,0	87,0	73100	10	73500	10	73300	10	72900	10
10,1	133,0	87,0	73101	10		10	73301	10	72901	10
10,2	133,0	87,0	73102	10	73502	10	73302	10	72902	10
10,3	133,0	87,0	73103	10		10	73303	10	72903	10
10,4	133,0	87,0	73104	10		10	73304	10	72904	10
10,5	133,0	87,0	73105	5	73505	5	73305	5	72905	5
10,6	133,0	87,0	73106	5		5	73306	5	72906	5
10,7	142,0	94,0	73107	5		5	73307	5	72907	5
10,8	142,0	94,0	73108	5		5	73308	5	72908	5
10,9	142,0	94,0	73109	5		5	73309	5	72909	5
11,0	142,0	94,0	73110	5	73510	5	73310	5	72910	5
11,1	142,0	94,0	73111	5		5	73311	5	72911	5
11,2	142,0	94,0	73112	5		5	73312	5	72912	5
11,3	142,0	94,0	73113	5		5	73313	5	72913	5
11,4	142,0	94,0	73114	5		5	73314	5	72914	5
11,5	142,0	94,0	73115	5	73515	5	73315	5	72915	5
11,6	142,0	94,0	73116	5		5	73316	5	72916	5
11,7	142,0	94,0	73117	5		5	73317	5	72917	5
11,8	142,0	94,0	73118	5		5	73318	5	72918	5
11,9	151,0	101,0	73119	5		5	73319	5	72919	5
12,0	151,0	101,0	73120	5	73520	5	73320	5	72920	5
12,1	151,0	101,0	73121	5		5	73321	5	72921	5
12,2	151,0	101,0	73122	5		5	73322	5	72922	5
12,3	151,0	101,0	73123	5		5	73323	5	72923	5
12,4	151,0	101,0	73124	5		5	73324	5	72924	5
12,5	151,0	101,0	73125	5	73525	5	73325	5	72925	5
12,6	151,0	101,0	73126	5		5	73326	5	72926	5
12,7	151,0	101,0	73127	5		5	73327	5	72927	5
12,8	151,0	101,0	73128	5		5	73328	5	72928	5
12,9	151,0	101,0	73129	5		5	73329	5	72929	5
13,0	151,0	101,0	73130	5	73530	5	73330	5	72930	5
13,5	160,0	108,0	73135	5		5	73335	5	72935	5
14,0	160,0	108,0	73140	5		5	73340	5	72940	5
14,5	169,0	114,0	73145	5		5	73345	5	72945	5
15,0	169,0	114,0	73150	5		5	73350	5	72950	5
15,5	178,0	120,0	73155	5		5	73355	5	72955	5
16,0	178,0	120,0	73160	5		5	73360	5	72960	5

Spiralbohrer • Twist Drills

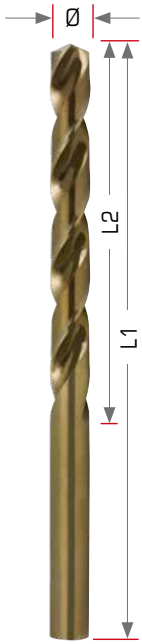

Spiralbohrer | **Twist Drills** DIN 338 | Typ VA | **HSSE-Co 5**

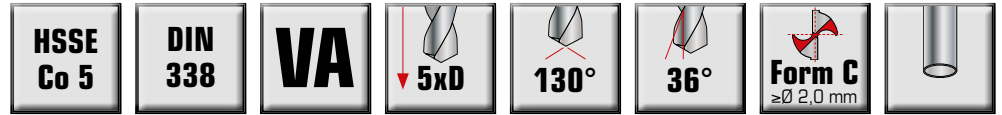

Kräftiger Hochleistungsbohrer, der durch den Kobaltanteil für eine höhere Wärmehärtebeständigkeit sorgt. Ideal zum Bohren von rost-, säure- und hitzebeständigem Stahl mit hoher Festigkeit.

Powerful right-hand cutting high-performance drill with distinctive heat resistance. Ideal for drilling high-strength stainless, acid-resistant and heat-resistant steel.



Sets: Seite 282 | **Page 282**

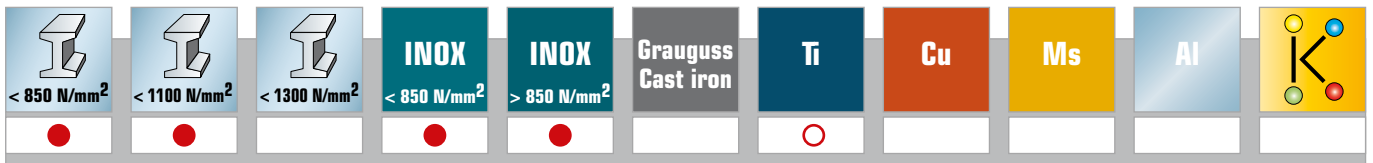

● empfohlen | recommended ○ bedingt geeignet | partly suitable

Ø	L1	L2	HSSE-Co 5	
			Code	Stk. pcs.
1,0	34,0	12,0	74010	10
1,1	36,0	14,0	74011	10
1,2	38,0	16,0	74012	10
1,3	38,0	16,0	74013	10
1,4	40,0	18,0	74014	10
1,5	40,0	18,0	74015	10
1,6	43,0	20,0	74016	10
1,7	43,0	20,0	74017	10
1,8	46,0	22,0	74018	10
1,9	46,0	22,0	74019	10
2,0	49,0	24,0	74020	10
2,1	49,0	24,0	74021	10
2,2	53,0	27,0	74022	10
2,3	53,0	27,0	74023	10
2,4	57,0	30,0	74024	10
2,5	57,0	30,0	74025	10
2,6	57,0	30,0	74026	10
2,7	61,0	33,0	74027	10
2,8	61,0	33,0	74028	10
2,9	61,0	33,0	74029	10
3,0	61,0	33,0	74030	10
3,1	65,0	36,0	74031	10
3,2	65,0	36,0	74032	10
3,3	65,0	36,0	74033	10
3,4	70,0	39,0	74034	10
3,5	70,0	39,0	74035	10
3,6	70,0	39,0	74036	10
3,7	70,0	39,0	74037	10
3,8	75,0	43,0	74038	10

Ø	L1	L2	HSSE-Co 5	
			Code	Stk. pcs.
3,9	75,0	43,0	74039	10
4,0	75,0	43,0	74040	10
4,1	75,0	43,0	74041	10
4,2	75,0	43,0	74042	10
4,3	80,0	47,0	74043	10
4,4	80,0	47,0	74044	10
4,5	80,0	47,0	74045	10
4,6	80,0	47,0	74046	10
4,7	80,0	47,0	74047	10
4,8	86,0	52,0	74048	10
4,9	86,0	52,0	74049	10
5,0	86,0	52,0	74050	10
5,1	86,0	52,0	74051	10
5,2	86,0	52,0	74052	10
5,3	86,0	52,0	74053	10
5,4	93,0	57,0	74054	10
5,5	93,0	57,0	74055	10
5,6	93,0	57,0	74056	10
5,7	93,0	57,0	74057	10
5,8	93,0	57,0	74058	10
5,9	93,0	57,0	74059	10
6,0	93,0	57,0	74060	10
6,1	101,0	63,0	74061	10
6,2	101,0	63,0	74062	10
6,3	101,0	63,0	74063	10
6,4	101,0	63,0	74064	10
6,5	101,0	63,0	74065	10
6,6	101,0	63,0	74066	10
6,7	101,0	63,0	74067	10

Ø	L1	L2	HSSE-Co 5	
			Code	Stk. pcs.
6,8	109,0	69,0	74068	10
6,9	109,0	69,0	74069	10
7,0	109,0	69,0	74070	10
7,1	109,0	69,0	74071	10
7,2	109,0	69,0	74072	10
7,3	109,0	69,0	74073	10
7,4	109,0	69,0	74074	10
7,5	109,0	69,0	74075	10
7,6	117,0	75,0	74076	10
7,7	117,0	75,0	74077	10
7,8	117,0	75,0	74078	10
7,9	117,0	75,0	74079	10
8,0	117,0	75,0	74080	10
8,1	117,0	75,0	74081	10
8,2	117,0	75,0	74082	10
8,3	117,0	75,0	74083	10
8,4	117,0	75,0	74084	10
8,5	117,0	75,0	74085	10
8,6	125,0	81,0	74086	10
8,7	125,0	81,0	74087	10
8,8	125,0	81,0	74088	10
8,9	125,0	81,0	74089	10
9,0	125,0	81,0	74090	10

Ø	L1	L2	HSSE-Co 5	
			Code	Stk. pcs.
9,1	125,0	81,0	74091	10
9,2	125,0	81,0	74092	10
9,3	125,0	81,0	74093	10
9,4	125,0	81,0	74094	10
9,5	125,0	81,0	74095	10
9,6	133,0	87,0	74096	10
9,7	133,0	87,0	74097	10
9,8	133,0	87,0	74098	10
9,9	133,0	87,0	74099	10
10,0	133,0	87,0	74100	10
10,2	133,0	87,0	74102	10
10,5	133,0	87,0	74105	5
11,0	142,0	94,0	74110	5
11,5	142,0	94,0	74115	5
12,0	151,0	101,0	74120	5
12,5	151,0	101,0	74125	5
13,0	151,0	101,0	74130	5
13,5	160,0	108,0	74135	5
14,0	160,0	108,0	74140	5
14,5	169,0	114,0	74145	5
15,0	169,0	114,0	74150	5
15,5	178,0	120,0	74155	5
16,0	178,0	120,0	74160	5





Spiralbohrer | **Twist Drills** DIN 338 | Typ VA | **HSSE-Co 8**

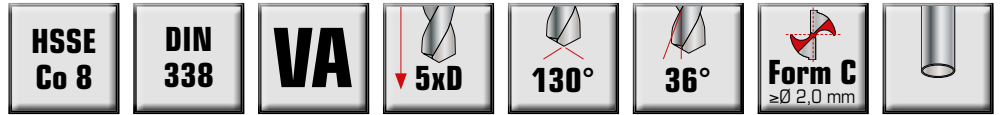

Kräftiger Sonderbohrer, der ideal für Titanlegierungen sowie rost-, säure- und hitzebeständigen austenitischen Stählen verwendbar ist. Weiterhin ist er für hochfeste Stähle mit niedriger Zähigkeit geeignet. Dieser Bohrer kann unter bestimmten Bedingungen für Sonderlegierungen wie Hastelloy, Inconell, Nimonic, usw. verwendet werden.

Powerful special drill that should ideally be used for titanium base alloys as well as stainless, acid-resistant and heat-resistant austenitic steels. It is also suitable for high strength steels with low ductility. Under certain conditions, these drills can be used for special alloys such as hastelloy, inconel and nimonic etc.

**HSSE
Co 8**



Set: Seite 282 | **Page 282**

Spiralbohrer • Twist Drills

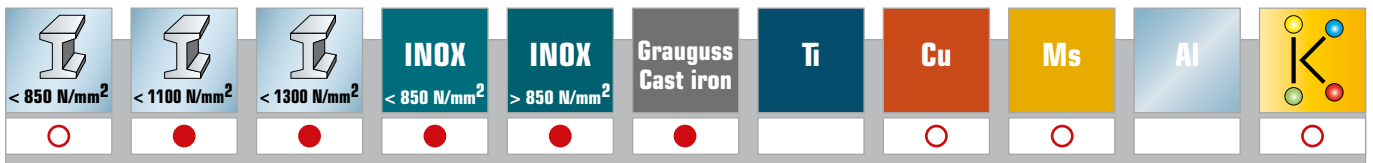

● empfohlen | recommended ○ bedingt geeignet | partly suitable

Ø	L1	L2	HSSE-Co 8	
			Code	Stk. pcs.
1,0	34,0	12,0	74610	10
1,5	40,0	18,0	74615	10
2,0	49,0	24,0	74620	10
2,5	57,0	30,0	74625	10
3,0	61,0	33,0	74630	10
3,3	65,0	36,0	74633	10
3,5	70,0	39,0	74635	10
4,0	75,0	43,0	74640	10
4,2	75,0	43,0	74642	10
4,5	80,0	47,0	74645	10
5,0	86,0	52,0	74650	10
5,5	93,0	57,0	74655	10
6,0	93,0	57,0	74660	10
6,5	101,0	63,0	74665	10
6,8	109,0	69,0	74668	10
7,0	109,0	69,0	74670	10
7,5	109,0	69,0	74675	10
8,0	117,0	75,0	74680	10

Ø	L1	L2	HSSE-Co 8	
			Code	Stk. pcs.
8,5	117,0	75,0	74685	10
9,0	125,0	81,0	74690	10
9,5	125,0	81,0	74695	10
10,0	133,0	87,0	74700	10
10,2	133,0	87,0	74702	10
10,5	133,0	87,0	74705	5
11,0	142,0	94,0	74710	5
11,5	142,0	94,0	74715	5
12,0	151,0	101,0	74720	5
12,5	151,0	101,0	74725	5
13,0	151,0	101,0	74730	5
13,5	160,0	108,0	74735	5
14,0	160,0	108,0	74740	5
14,5	169,0	114,0	74745	5
15,0	169,0	114,0	74750	5
15,5	178,0	120,0	74755	5
16,0	178,0	120,0	74760	5

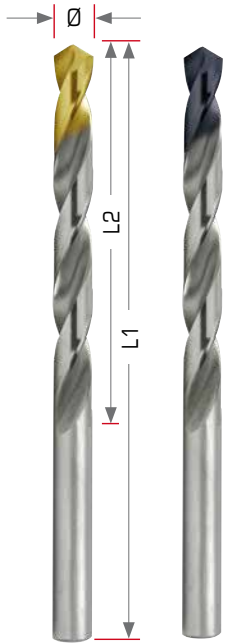

HSS-G
TIP
TIN

HSS-G
TIP
TiAlN

Spiralbohrer | **Twist Drills** DIN 338 | **Typ N** | **HSS-G**

mit **TIP-Beschichtung** | with **TIP Coating**

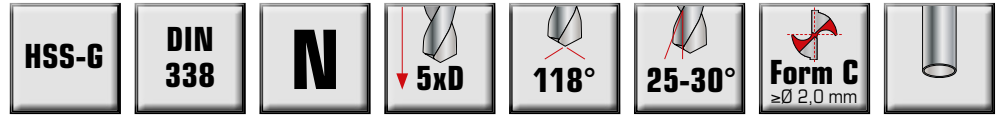





Leistungstarker, geschliffener Spiralbohrer, der im schneidaktiven Teil beschichtet ist. Die Titan-Nitrid-Beschichtung erhöht die Werkzeugstandzeiten und ermöglicht höhere Schnittgeschwindigkeiten sowie Vorschübe. Die Titan-Aluminium-Beschichtung ist darüber hinaus für besonders harte Materialien geeignet und benötigt kein Kühlmittel.

Powerful, ground twist drill with a coated active cutting part. The titanium nitride coating increases the tool life and allows higher cutting speeds and feed rates. The titanium-aluminum coating is also suitable for particularly hard materials and does not require coolant.



Sets: Seite 281 | **Page 281**

 < 850 N/mm ² ●	 < 1100 N/mm ² ○	 < 1300 N/mm ² ○	INOX < 850 N/mm ² ○	INOX > 850 N/mm ² ○	Grauguss Cast iron ○	Ti ○	Cu ○	Ms ○	Al ○	 ○
---	--	--	---	---	-----------------------------------	----------------	----------------	----------------	----------------	--

● empfohlen | recommended ○ bedingt geeignet | partly suitable

Ø	L1	L2	HSS-G		HSS-G	
			Code	Stk. pcs.	Code	Stk. pcs.
1,0	34,0	12,0	73610	10	73810	10
1,5	40,0	18,0	73615	10	73815	10
2,0	49,0	24,0	73620	10	73820	10
2,5	57,0	30,0	73625	10	73825	10
3,0	61,0	33,0	73630	10	73830	10
3,3	65,0	36,0	73633	10	73833	10
3,5	70,0	39,0	73635	10	73835	10
4,0	75,0	43,0	73640	10	73840	10
4,2	75,0	43,0	73642	10	73842	10
4,5	80,0	47,0	73645	10	73845	10
5,0	86,0	52,0	73650	10	73850	10
5,5	93,0	57,0	73655	10	73855	10
6,0	93,0	57,0	73660	10	73860	10
6,5	101,0	63,0	73665	10	73865	10
6,8	109,0	69,0	73668	10	73868	10
7,0	109,0	69,0	73670	10	73870	10
7,5	109,0	69,0	73675	10	73875	10
8,0	117,0	75,0	73680	10	73880	10

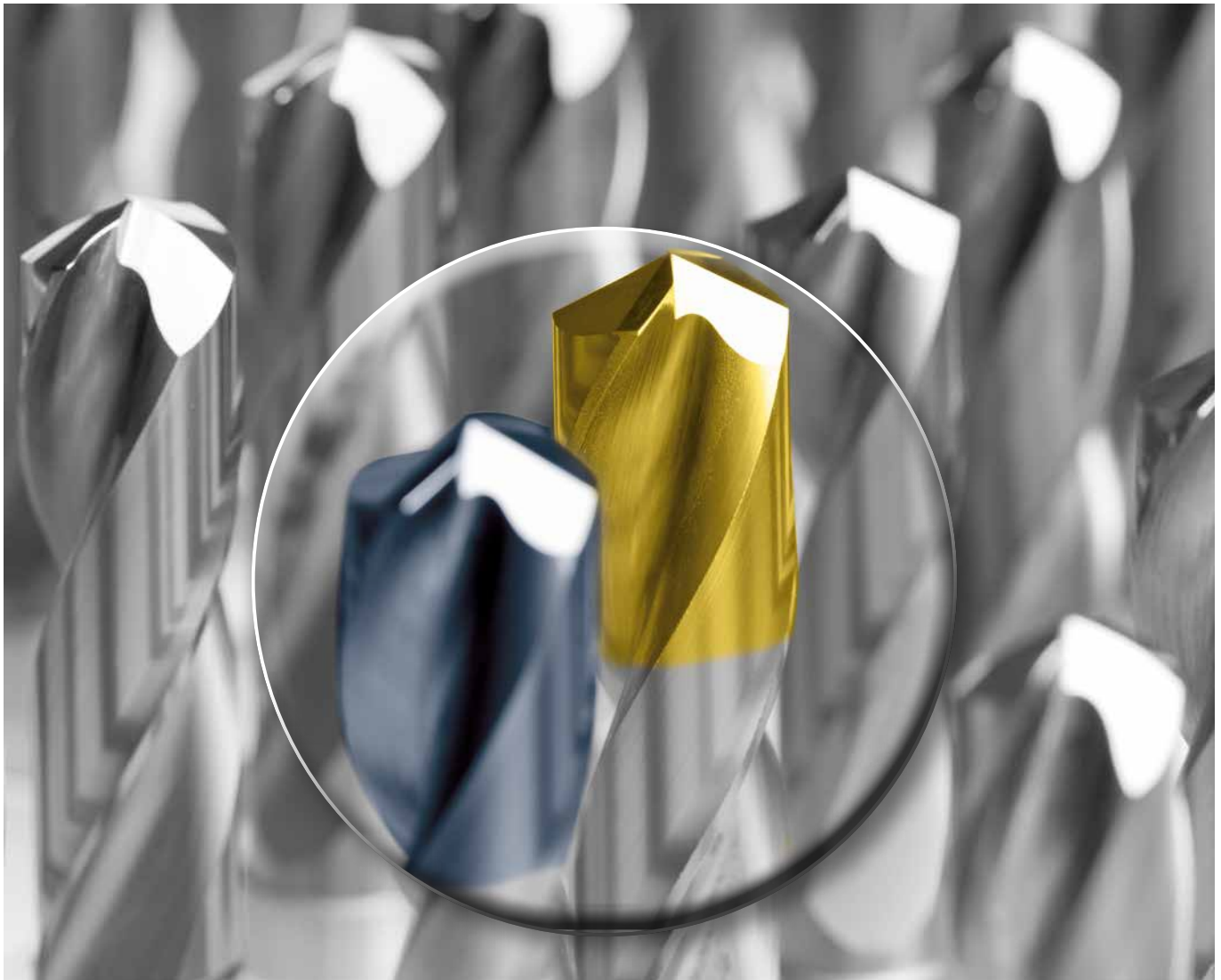

EXACT TIP-Beschichtung | EXACT TIP Coating





Ø	L1	L2	HSS-G		HSS-G	
			Code	Stk. pcs.	Code	Stk. pcs.
8,5	117,0	75,0	73685	10	73885	10
9,0	125,0	81,0	73690	10	73890	10
9,5	125,0	81,0	73695	10	73895	10
10,0	133,0	87,0	73700	10	73900	10
10,2	133,0	87,0	73702	10	73902	10
10,5	133,0	87,0	73705	5	73905	5
11,0	142,0	94,0	73710	5	73910	5
11,5	142,0	94,0	73715	5	73915	5
12,0	151,0	101,0	73720	5	73920	5
12,5	151,0	101,0	73725	5	73925	5
13,0	151,0	101,0	73730	5	73930	5
13,5	160,0	108,0	73735	5	73935	5
14,0	160,0	108,0	73740	5	73940	5
14,5	169,0	114,0	73745	5	73945	5
15,0	169,0	114,0	73750	5	73950	5
15,5	178,0	120,0	73755	5	73955	5
16,0	178,0	120,0	73760	5	73960	5



HSSE Co 5

Spiralbohrer | **Twist Drills** DIN 338 | **Typ N** | **HSSE-Co 5**

mit **ROTASTOP®**-Schaft | **ROTASTOP®**-Shank



HSSE Co 5	DIN 338	N	 5xD	 130°	 25-30°	 Form C	 ROTASTOP Die Kraft der Form
------------------	----------------	----------	--	--	---	---	---

Der leistungsstarke, komplett geschliffene Spiralbohrer verfügt über eine präzise Rundlaufgenauigkeit. Der Kobalt-Anteil sorgt für eine höhere Warmhärtebeständigkeit. Für legierte und unlegierte Stähle, Warm- und Kaltarbeitsstähle, Vergütungs- und Einsatzstähle sowie für rost- und säurebeständige Stähle. Der **ROTASTOP®**-Schaft verhindert ein Durchrutschen im Bohrfutter und ermöglicht optimale Drehmomentübertragung.

This high capacity, completely ground twist drill has increased true running accuracy. The cobalt content provides higher heat hardness strength. For alloyed and non-alloyed steel, hot and cold work steel, heat-treated and case-hardened steel and for stainless and acid-resistant steel. The **ROTASTOP®**-shank prevents slipping in the chuck and enables an optimum transmission of the torque.



Sets: Seite 285 | **Page 285**

 < 850 N/mm² ●	 < 1100 N/mm² ●	 < 1300 N/mm² ○	INOX < 850 N/mm² ●	INOX > 850 N/mm² ○	Grauguss Cast iron ○	Ti ○	Cu ○	Ms ○	Al ○	 ○
--	---	---	--	--	--	----------------	----------------	----------------	----------------	--

● empfohlen | recommended ○ bedingt geeignet | partly suitable

Ø	L1	L2	HSSE-Co 5	
			Code	Stk. pcs.
1,0	34	12	76410	10
1,5	40	18	76415	10
2,0	49	24	76420	10
2,5	57	30	76425	10
3,0	61	33	76430	10
3,3	65	36	76433	10
3,5	70	39	76435	10
4,0	75	43	76440	10
4,2	75	43	76442	10
4,5	80	47	76445	10
4,8	86	52	76448	10
5,0	93	57	76450	10
5,5	93	57	76455	10
6,0	101	63	76460	10
6,5	109	69	76465	10

Ø	L1	L2	HSSE-Co 5	
			Code	Stk. pcs.
6,8	109	69	76468	10
7,0	109	69	76470	10
7,5	117	75	76475	10
8,0	117	75	76480	10
8,5	125	81	76485	10
9,0	125	81	76490	10
9,5	133	87	76495	10
10,0	133	87	76500	10
10,5	133	87	76505	5
11,0	142	94	76510	5
11,5	142	94	76515	5
12,0	151	101	76520	5
12,5	151	101	76525	5
13,0	151	101	76530	5

INNOVATION BY

EXACT
PRÄZISIONSWERKZEUGE

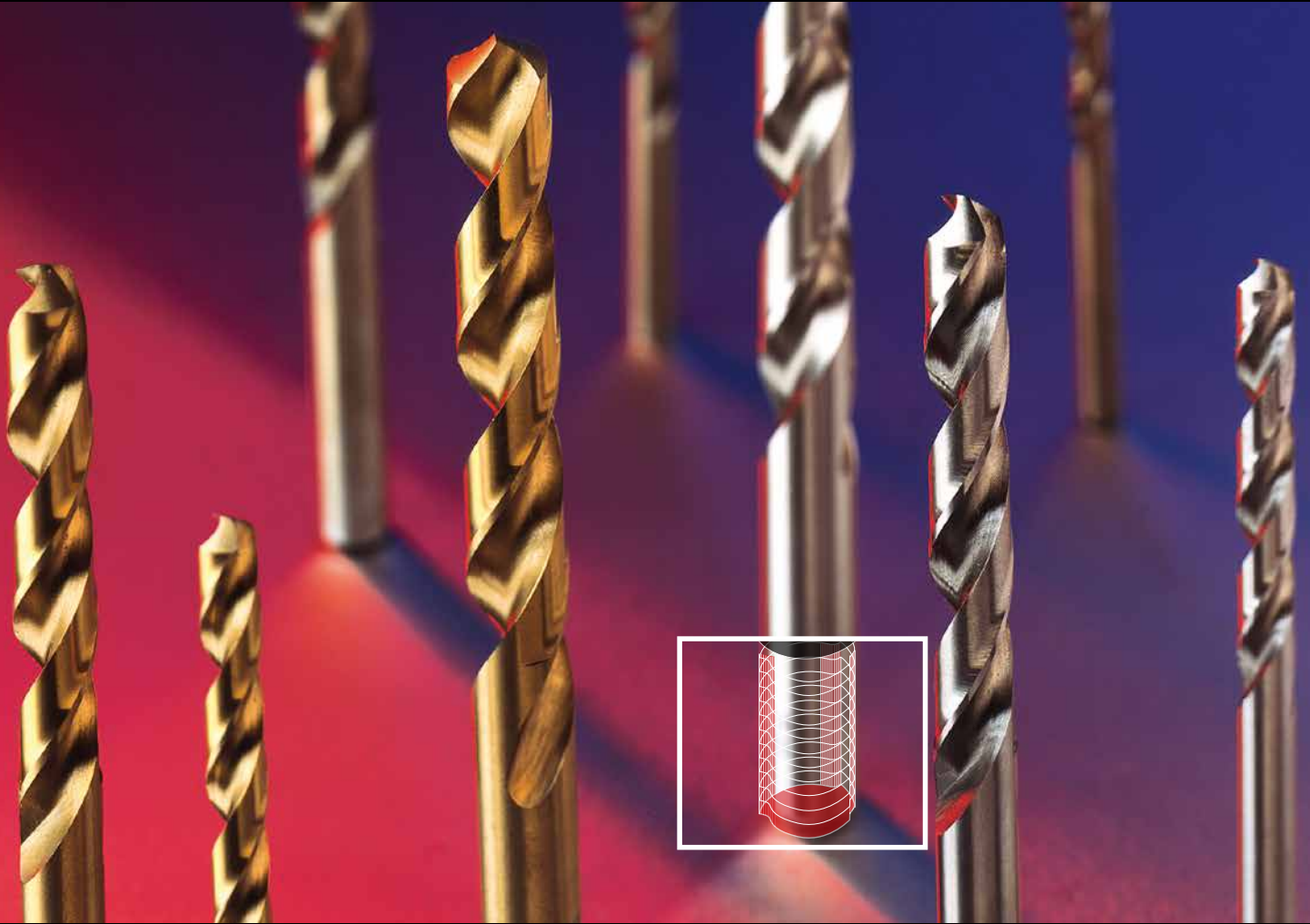

ROTASTOP®-SCHAFT

INNOVATION | **INNOVATION**



Durch ansteigende Formen spannt sich ROTASTOP® selbst im Bohrfutter

ROTASTOP® chucks itself automatically by rising contours

VORTEILE | **ADVANTAGES**

- ✓ Kein Durchrutschen im Bohrfutter
- ✓ ROTASTOP® spannt sich selbst im Bohrfutter
- ✓ Optimale Drehmomentübertragung
- ✓ Einfacher Werkzeugwechsel

- ✓ No slipping in the chuck
- ✓ ROTASTOP® chucks itself automatically
- ✓ Optimal transmission of the torque
- ✓ Easy tool changing

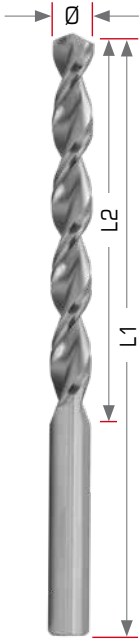

Spiralbohrer | Twist Drills DIN 338 | Typ EX-TL | HSS-G

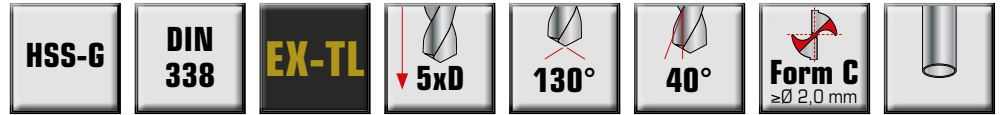

Stabiler Mehrbereichsbohrer mit verstärktem Bohrerker und einer parabolisch geformten Spannute zur idealen Spanabfuhr. Er ist ideal zum Bohren von mittel- und langspannenden Werkstoffen. Durch seinen dicken Kern und die spezielle Spannute mit gerundeter hinterer Kante ist dieser Bohrer für Hochleistungsanwendungen bestens geeignet. Er deckt in weiten Bereichen die Typen N, H und W ab.

Stable multirange drill with reinforced drill core and parabolic flute for ideal chip removal. Ideal for drilling medium and long-chipping materials. Thanks to its thick core and the special flute with a rounded rear edge, this drill is best suited for high-performance use. It covers types N, H and W for a wide range of applications.

HSS-G



Sets: Seite 283 | Page 283

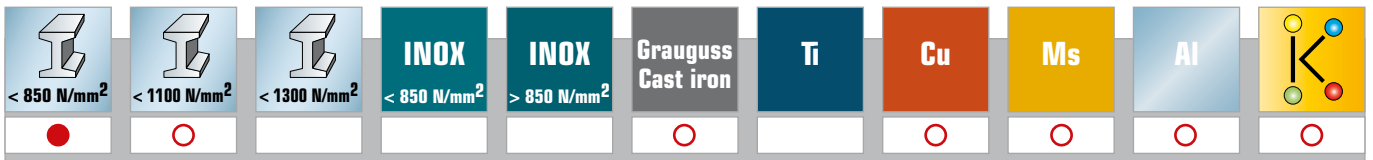

● empfohlen | recommended ○ bedingt geeignet | partly suitable

Ø	L1	L2	HSS-G	
			Code	Stk. pcs.
1,0	34,0	12,0	75010	10
1,5	40,0	18,0	75015	10
2,0	49,0	24,0	75020	10
2,5	57,0	30,0	75025	10
3,0	61,0	33,0	75030	10
3,3	65,0	36,0	75033	10
3,5	70,0	39,0	75035	10
4,0	75,0	43,0	75040	10
4,2	75,0	43,0	75042	10
4,5	80,0	47,0	75045	10
5,0	86,0	52,0	75050	10
5,5	93,0	57,0	75055	10
6,0	93,0	57,0	75060	10
6,5	101,0	63,0	75065	10
6,8	109,0	69,0	75068	10
7,0	109,0	69,0	75070	10
7,5	109,0	69,0	75075	10
8,0	117,0	75,0	75080	10

Ø	L1	L2	HSS-G	
			Code	Stk. pcs.
8,5	117,0	75,0	75085	10
9,0	125,0	81,0	75090	10
9,5	125,0	81,0	75095	10
10,0	133,0	87,0	75100	10
10,2	133,0	87,0	75102	10
10,5	133,0	87,0	75105	5
11,0	142,0	94,0	75110	5
11,5	142,0	94,0	75115	5
12,0	151,0	101,0	75120	5
12,5	151,0	101,0	75125	5
13,0	151,0	101,0	75130	5

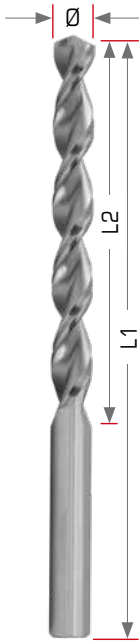

Spiralbohrer | **Twist Drills** DIN 338 | Typ **EX-TL** | **HSSE-Co 5**

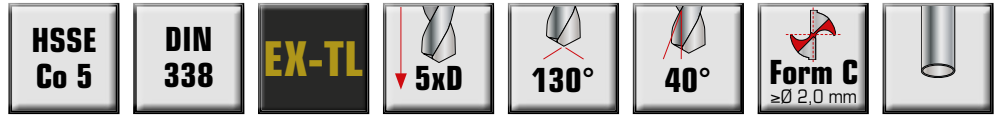

Sehr stabiler Mehrbereichsbohrer mit hervorragender Warmhärtebeständigkeit, verstärktem Bohrerker und einer parabolisch geformten Spannutt zur idealen Spanabfuhr. Er ist ideal zum Bohren von mittel- und langspanenden Werkstoffen. Durch seinen dicken Kern und die spezielle Spannutt mit einer gerundeten hinteren Kante ist dieser Bohrer für Hochleistungsanwendungen bestens geeignet. Er deckt in weiten Bereichen die Typen N, H und W ab.

Highly stable multirange drill with outstanding heat resistance, a reinforced drill core and a parabolic flute for ideal chip removal. Ideal for drilling medium and long-chipping materials. Thanks to its thick core and the special flute with a rounded rear edge, this drill is best suited for high-performance use. It covers types N, H and W for a wide range of applications.

**HSSE
Co 5**



Sets: Seite 283 | **Page 283**

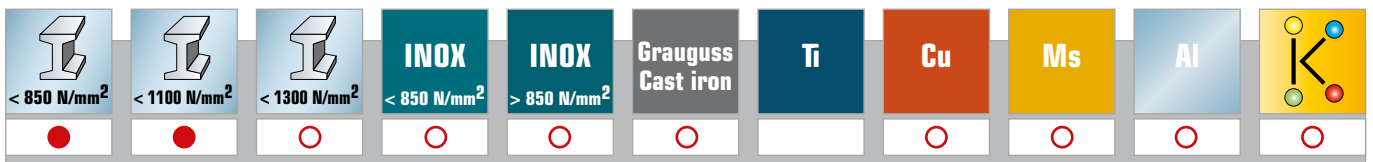

● empfohlen | recommended ○ bedingt geeignet | partly suitable

Ø	L1	L2	HSSE-Co 5	
			Code	Stk. pcs.
1,0	34,0	12,0	75610	10
1,5	40,0	18,0	75615	10
2,0	49,0	24,0	75620	10
2,5	57,0	30,0	75625	10
3,0	61,0	33,0	75630	10
3,3	65,0	36,0	75633	10
3,5	70,0	39,0	75635	10
4,0	75,0	43,0	75640	10
4,2	75,0	43,0	75642	10
4,5	80,0	47,0	75645	10
5,0	86,0	52,0	75650	10
5,5	93,0	57,0	75655	10
6,0	93,0	57,0	75660	10
6,5	101,0	63,0	75665	10
6,8	109,0	69,0	75668	10
7,0	109,0	69,0	75670	10
7,5	109,0	69,0	75675	10
8,0	117,0	75,0	75680	10

Ø	L1	L2	HSSE-Co 5	
			Code	Stk. pcs.
8,5	117,0	75,0	75685	10
9,0	125,0	81,0	75690	10
9,5	125,0	81,0	75695	10
10,0	133,0	87,0	75700	10
10,2	133,0	87,0	75702	10
10,5	133,0	87,0	75705	5
11,0	142,0	94,0	75710	5
11,5	142,0	94,0	75715	5
12,0	151,0	101,0	75720	5
12,5	151,0	101,0	75725	5
13,0	151,0	101,0	75730	5
13,5	160,0	108,0	75735	5
14,0	160,0	108,0	75740	5
14,5	169,0	114,0	75745	5
15,0	169,0	114,0	75750	5
15,5	178,0	120,0	75755	5
16,0	178,0	120,0	75760	5

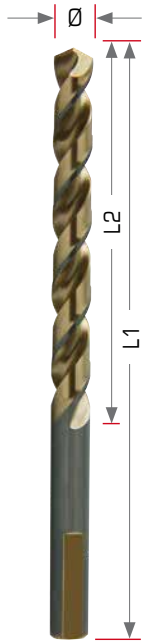

Spiralbohrer | Twist Drills DIN 338 | Typ UNI | HSS-G

HSS-G	DIN 338	UNI	5xD	135°	40°	Form C ≥Ø 2,0 mm	≥Ø 4,0 mm
--------------	----------------	------------	-----	------	-----	---------------------	-----------

Dieser Hochleistungsspiralbohrer ist speziell für den portablen Einsatz in Bohrmaschinen und Akku-Bohrschraubern entwickelt worden (beste Leistung bis 5,0 mm Materialstärke).

High performance twist drill for all-purpose use in drilling machines and cordless drills.
(Materials up to 5,0 mm thickness)

HSS-G



Sets: Seite 284 | Page 284

< 850 N/mm ²	< 1100 N/mm ²	< 1300 N/mm ²	INOX < 850 N/mm ²	INOX > 850 N/mm ²	Grauguss Cast iron	Ti	Cu	Ms	Al	
●	○						○	○	○	○

● empfohlen | recommended ○ bedingt geeignet | partly suitable

Ø	L1	L2	HSS-G	
			Code	Stk. pcs.
1,0	34,0	12,0	76010	10
1,5	40,0	18,0	76015	10
2,0	49,0	24,0	76020	10
2,5	57,0	30,0	76025	10
3,0	61,0	33,0	76030	10
3,3	65,0	36,0	76033	10
3,5	70,0	39,0	76035	10
4,0	75,0	43,0	76040	10
4,2	75,0	43,0	76042	10
4,5	80,0	47,0	76045	10
5,0	86,0	52,0	76050	10
5,5	93,0	57,0	76055	10
6,0	93,0	57,0	76060	10
6,5	101,0	63,0	76065	10
6,8	109,0	69,0	76068	10
7,0	109,0	69,0	76070	10
7,5	109,0	69,0	76075	10
8,0	117,0	75,0	76080	10
8,5	117,0	75,0	76085	10
9,0	125,0	81,0	76090	10
9,5	125,0	81,0	76095	10
10,0	133,0	87,0	76100	10
10,2	133,0	87,0	76102	10
10,5	133,0	87,0	76105	5
11,0	142,0	94,0	76110	5
11,5	142,0	94,0	76115	5
12,0	151,0	101,0	76120	5
12,5	151,0	101,0	76125	5
13,0	151,0	101,0	76130	5

Vorteile | Advantages

- Der Dreiflächenschaft sorgt für hervorragende Fixierung im Bohrfutter bei geringem Kraftaufwand. Zudem sorgt der Schaft für eine optimale Kraftübertragung und verhindert das Durchdrehen des Bohrers!
- Die 135° Hochleistungsschneide sorgt für eine sehr hohe Zentriergenauigkeit, insbesondere bei handgeführten Anwendungen mit dem Akku-Bohrschrauber. Durch die Schneide wird das Abrutschen beim Anbohren von gewölbten Oberflächen verhindert.
- Durch Verringerung der Schnittkräfte wird die Lebensdauer des Akkus erhöht.
- Die schwarze Fase erhöht die Verschleißfestigkeit und verhindert Kaltverschweißungen und Aufbauschnitten.
- Der 40° Drallwinkel ermöglicht eine perfekte und schnelle Spanabfuhr und sorgt für hohe Schnittgeschwindigkeiten bei erhöhter Stabilität und Genauigkeit.
- The 3-surface-shank provides an excellent fixing within the drill chuck with little effort. In addition, the shank ensures an ideal power transmission. No spinning of the drill!
- The 135° high performance cutting edge ensures a very high aligned preciseness, particularly when hand-operated with a cordless drilling machine. The edge prevents sliding off corrugated surfaces whilst spot-drilling.
- Increased wear resistance of the rechargeable battery due to reduction of cutting forces.
- The black bevel increases the wear resistance and prevents cold welding and build-up edges.
- The 40° helix angle enables a perfect and fast chip removal and provides a high cutting speed along with increased stability and accuracy.

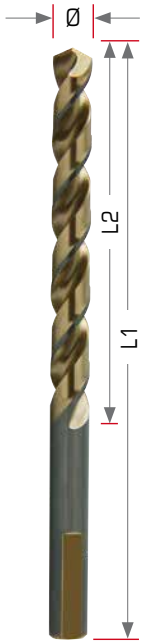

Spiralbohrer | **Twist Drills** DIN 338 | Typ **UNI** | **HSSE-Co 5**

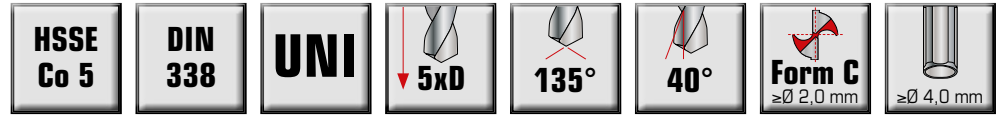

Dieser Hochleistungsspiralbohrer ist speziell für den portablen Einsatz in Bohrmaschinen und Akku-Bohrschraubern entwickelt worden (beste Leistung bis 5,0 mm Materialstärke).



High performance twist drill for all-purpose use in drilling machines and cordless drills.
(Materials up to 5,0 mm thickness)

**HSSE
Co 5**



Sets: Seite 284 | **Page 284**

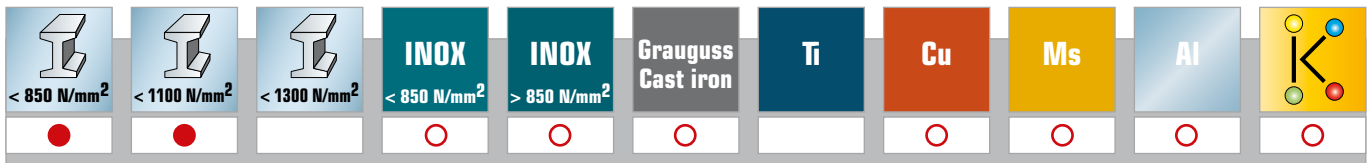

● empfohlen | recommended ○ bedingt geeignet | partly suitable

Ø	L1	L2	HSSE-Co 5	
			Code	Stk. pcs.
1,0	34,0	12,0	76210	10
1,5	40,0	18,0	76215	10
2,0	49,0	24,0	76220	10
2,5	57,0	30,0	76225	10
3,0	61,0	33,0	76230	10
3,3	65,0	36,0	76233	10
3,5	70,0	39,0	76235	10
4,0	75,0	43,0	76240	10
4,2	75,0	43,0	76242	10
4,5	80,0	47,0	76245	10
5,0	86,0	52,0	76250	10
5,5	93,0	57,0	76255	10
6,0	93,0	57,0	76260	10
6,5	101,0	63,0	76265	10
6,8	109,0	69,0	76268	10
7,0	109,0	69,0	76270	10
7,5	109,0	69,0	76275	10
8,0	117,0	75,0	76280	10
8,5	117,0	75,0	76285	10
9,0	125,0	81,0	76290	10
9,5	125,0	81,0	76295	10
10,0	133,0	87,0	76300	10
10,2	133,0	87,0	76302	10
10,5	133,0	87,0	76305	5
11,0	142,0	94,0	76310	5
11,5	142,0	94,0	76315	5
12,0	151,0	101,0	76320	5
12,5	151,0	101,0	76325	5
13,0	151,0	101,0	76330	5





Spiralbohrer | **Twist Drills** **DIN 338 | Typ N | HSS-G** **reduzierter Schaft | **reduced shank****

HSS-G	DIN 338	N	5xD	118°	20-30°	Form C	
--------------	----------------	----------	-----	------	--------	--------	--

Ideal geeignet zum Bohren größerer Bohrdurchmesser mit allen gängigen Bohrmaschinen mit einem Spannfutter bis 13,0 mm.

Ideally suitable for drilling larger drilling diameters on all commonly-used drilling machines with a clamping chuck up to 13,0 mm.

 < 850 N/mm ²	 < 1100 N/mm ²	 < 1300 N/mm ²	INOX < 850 N/mm ²	INOX > 850 N/mm ²	Grauguss Cast iron	Ti	Cu	Ms	Al	
●	○		○	○	○		○	○	○	○

● empfohlen | recommended ○ bedingt geeignet | partly suitable

Ø1	L1	L3	Ø2	HSS-G	
				Code	Stk. pcs.
10,5	133,0	30,0	10	38231	1
11,0	142,0	30,0	10	38232	1
11,5	142,0	30,0	10	38233	1
12,0	151,0	30,0	10	38234	1
12,5	151,0	30,0	10	38235	1
13,0	151,0	30,0	10	38236	1
13,5	160,0	30,0	10	38237	1
14,0	160,0	30,0	10	38238	1
14,5	169,0	30,0	10	38239	1
15,0	169,0	30,0	10	38240	1
15,5	178,0	30,0	10	38241	1
16,0	178,0	30,0	10	38242	1
16,5	184,0	35,0	13	38243	1
17,0	184,0	35,0	13	38244	1
17,5	191,0	35,0	13	38245	1
18,0	191,0	35,0	13	38246	1
18,5	198,0	35,0	13	38247	1
19,0	198,0	35,0	13	38248	1
19,5	205,0	35,0	13	38249	1
20,0	205,0	35,0	13	38250	1





**HSSE
Co 5**

Spiralbohrer | Twist Drills
DIN 338 | Typ N | HSSE-Co 5
reduzierter Schaft | reduced shank

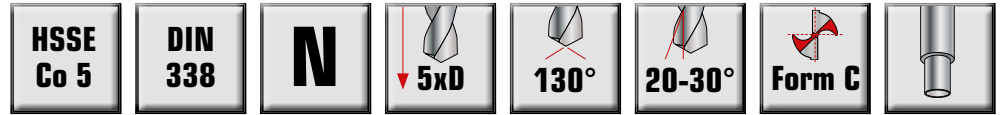

Ideal geeignet zum Bohren größerer Bohrdurchmesser mit allen gängigen Bohrmaschinen mit einem Spannfutter bis 13,0 mm.

Ideally suitable for drilling larger drilling diameters on all commonly-used drilling machines with a clamping chuck up to 13,0 mm.

Spiralbohrer • Twist Drills

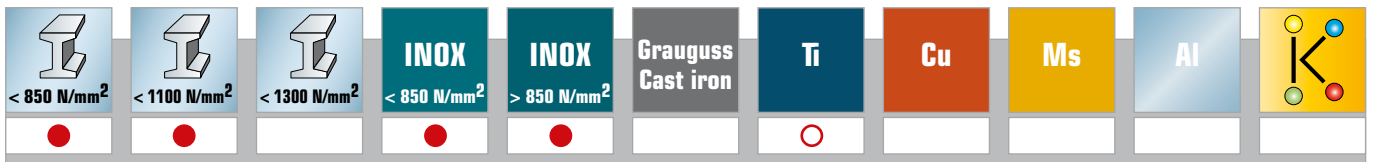

● empfohlen | recommended ○ bedingt geeignet | partly suitable

Ø1	L1	L3	Ø2	HSSE-Co 5	
				Code	Stk. pcs.
10,5	133,0	30,0	10	38261	1
11,0	142,0	30,0	10	38262	1
11,5	142,0	30,0	10	38263	1
12,0	151,0	30,0	10	38264	1
12,5	151,0	30,0	10	38265	1
13,0	151,0	30,0	10	38266	1
13,5	160,0	30,0	10	38267	1
14,0	160,0	30,0	10	38268	1
14,5	169,0	30,0	10	38269	1
15,0	169,0	30,0	10	38270	1
15,5	178,0	30,0	10	38271	1
16,0	178,0	30,0	10	38272	1
16,5	184,0	35,0	13	38273	1
17,0	184,0	35,0	13	38274	1
17,5	191,0	35,0	13	38275	1
18,0	191,0	35,0	13	38276	1
18,5	198,0	35,0	13	38277	1
19,0	198,0	35,0	13	38278	1
19,5	205,0	35,0	13	38279	1
20,0	205,0	35,0	13	38280	1



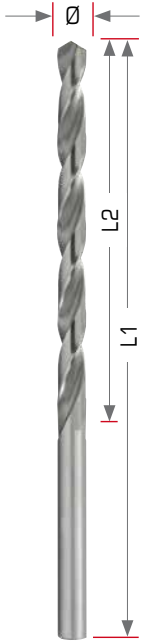

Spiralbohrer | Twist Drills DIN 340 | Typ N | HSS-G

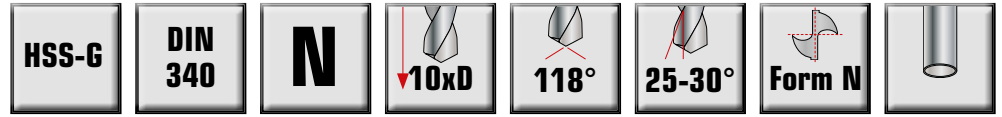

Leistungstarker Standardbohrer zum Bohren von legiertem und unlegiertem Stahl, Stahlguss und Gusseisen. Er weist eine hohe Bruchsicherheit auf.

High-performance ground standard twist drill made from heavy-duty high speed steel. The fully ground twist drill has a precise concentricity.

HSS-G

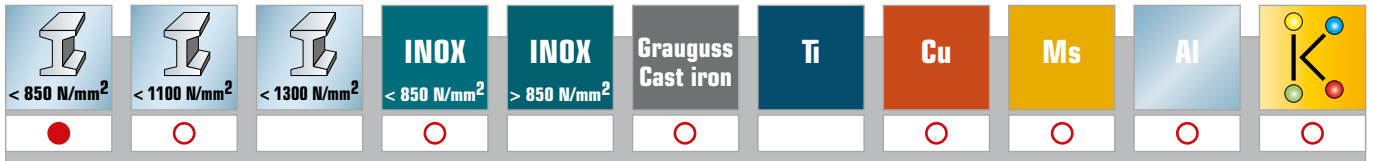

● empfohlen | recommended ○ bedingt geeignet | partly suitable

Ø	L1	L2	HSS-G	
			Code	Stk. pcs.
2,5	95,0	62,0	36201	10
3,0	100,0	66,0	36202	10
3,1	106,0	69,0	36203	10
3,2	106,0	69,0	36204	10
3,3	106,0	69,0	36205	10
3,4	112,0	73,0	36206	10
3,5	112,0	73,0	36207	10
3,6	112,0	73,0	36208	10
3,7	112,0	73,0	36209	10
3,8	119,0	78,0	36210	10
3,9	119,0	78,0	36211	10
4,0	119,0	78,0	36212	10
4,1	119,0	78,0	36213	10
4,2	119,0	78,0	36214	10
4,3	126,0	82,0	36215	10
4,4	126,0	82,0	36216	10
4,5	126,0	82,0	36217	10
4,6	126,0	82,0	36218	10
4,7	126,0	82,0	36219	10
4,8	132,0	87,0	36220	10
4,9	132,0	87,0	36221	10
5,0	132,0	87,0	36222	10
5,1	132,0	87,0	36223	10
5,2	132,0	87,0	36224	10
5,3	132,0	87,0	36225	10
5,4	139,0	91,0	36226	10
5,5	139,0	91,0	36227	10

Ø	L1	L2	HSS-G	
			Code	Stk. pcs.
5,6	139,0	91,0	36228	10
5,7	139,0	91,0	36229	10
5,8	139,0	91,0	36230	10
5,9	139,0	91,0	36231	10
6,0	139,0	91,0	36232	10
6,1	148,0	97,0	36233	10
6,2	148,0	97,0	36234	10
6,3	148,0	97,0	36235	10
6,4	148,0	97,0	36236	10
6,5	148,0	97,0	36237	10
6,6	148,0	97,0	36238	10
6,7	148,0	97,0	36239	10
6,8	156,0	102,0	36240	10
6,9	156,0	102,0	36241	10
7,0	156,0	102,0	36242	10
7,5	156,0	102,0	36247	10
8,0	165,0	109,0	36252	10
8,5	165,0	109,0	36257	10
9,0	175,0	115,0	36262	10
9,5	175,0	115,0	36267	10
10,0	184,0	121,0	36272	10
10,5	184,0	121,0	36273	5
11,0	195,0	128,0	36274	5
11,5	195,0	128,0	36275	5
12,0	205,0	134,0	36276	5
12,5	205,0	134,0	36277	5
13,0	205,0	134,0	36278	5

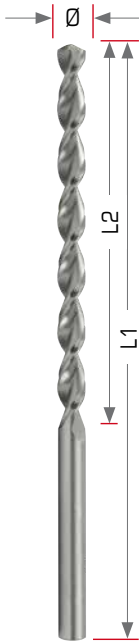

Spiralbohrer | **Twist Drills** DIN 340 | Typ **EX-TL** | **HSSE-Co 5**

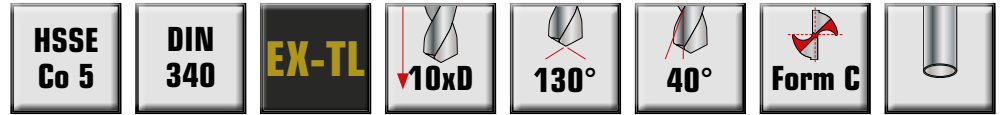

Sehr stabiler Mehrbereichsbohrer mit hervorragender Warmhärtebeständigkeit, verstärktem Bohrerkerne und einer parabolisch geformten Spannute zur idealen Spanabfuhr. Er ist ideal zum Bohren von mittel- und langspannenden Werkstoffen. Durch seinen dicken Kern und die spezielle Spannute mit einer gerundeten hinteren Kante ist dieser Bohrer für Hochleistungsanwendungen bestens geeignet. Er deckt in weiten Bereichen die Typen N, H und W ab.

Highly stable multirange drill with outstanding heat resistance, a reinforced drill core and a parabolic flute for ideal chip removal. Ideal for drilling medium and long-chipping materials. Thanks to its thick core and the special flute with a rounded rear edge, this drill is best suited for high-performance use. It covers types N, H and W for a wide range of applications.

**HSSE
Co 5**

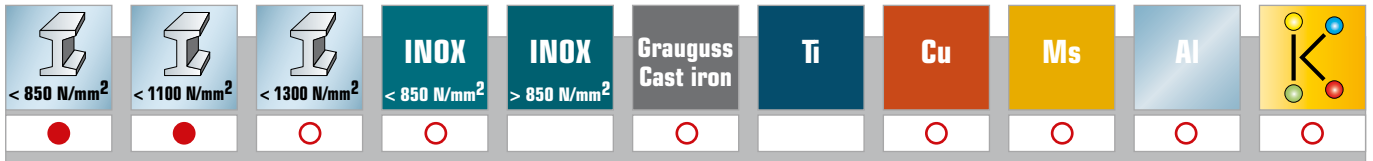

● empfohlen | recommended ○ bedingt geeignet | partly suitable

Ø	L1	L2	HSSE-Co 5	
			Code	Stk. pcs.
2,5	95,0	62,0	36305	10
3,0	100,0	66,0	36306	10
3,3	106,0	69,0	36307	10
3,5	112,0	73,0	36308	10
4,0	119,0	78,0	36309	10
4,2	119,0	78,0	36310	10
4,5	126,0	82,0	36311	10
5,0	132,0	87,0	36312	10
5,5	139,0	91,0	36313	10
6,0	139,0	91,0	36314	10
6,5	148,0	97,0	36315	10
6,8	156,0	102,0	36316	10
7,0	156,0	102,0	36317	10
7,5	156,0	102,0	36318	10
8,0	165,0	109,0	36319	10
8,5	165,0	109,0	36320	10
9,0	175,0	115,0	36321	10
9,5	175,0	115,0	36322	10
10,0	184,0	121,0	36323	10
10,5	184,0	121,0	36325	5
11,0	195,0	128,0	36326	5
11,5	195,0	128,0	36327	5
12,0	205,0	134,0	36328	5
12,5	205,0	134,0	36329	5
13,0	205,0	134,0	36330	5





Spiralbohrer | Twist Drills DIN 345 | Typ N | HSS-G

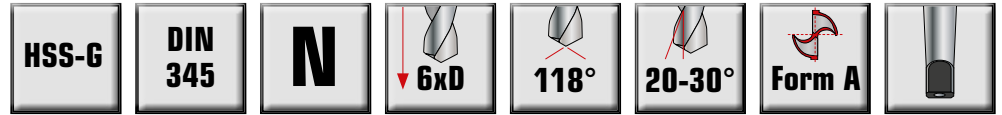

Leistungstarker Standardbohrer mit Morsekegel zum Bohren von legiertem und unlegiertem Stahl, Stahlguss und Gusseisen. Er weist eine hohe Bruchsicherheit auf.

Highly efficient standard drill with morse taper. For drilling steel, cast steel and cast iron – alloyed and unalloyed. Highly secure against fracture.

HSS-G



● empfohlen | recommended ○ bedingt geeignet | partly suitable

Ø	L1	L2	Stk.	HSS-G	
				Code	Stk. pcs.
10,0	168,0	87,0	1	36001	1
10,5	168,0	87,0	1	36002	1
11,0	175,0	94,0	1	36003	1
11,5	175,0	94,0	1	36004	1
12,0	182,0	101,0	1	36005	1
12,5	182,0	101,0	1	36006	1
13,0	182,0	101,0	1	36007	1
13,5	189,0	108,0	1	36008	1
14,0	189,0	108,0	1	36009	1
14,5	212,0	114,0	2	36010	1
15,0	212,0	114,0	2	36011	1
15,5	218,0	120,0	2	36012	1
16,0	218,0	120,0	2	36013	1
16,5	223,0	125,0	2	36014	1
17,0	223,0	125,0	2	36015	1
17,5	228,0	130,0	2	36016	1
18,0	228,0	130,0	2	36017	1
18,5	233,0	135,0	2	36018	1
19,0	233,0	135,0	2	36019	1
19,5	238,0	140,0	2	36020	1
20,0	238,0	140,0	2	36021	1
20,5	243,0	145,0	2	36022	1
21,0	243,0	145,0	2	36023	1

Ø	L1	L2	Stk.	HSS-G	
				Code	Stk. pcs.
21,5	248,0	150,0	2	36024	1
22,0	248,0	150,0	2	36025	1
22,5	253,0	155,0	2	36026	1
23,0	253,0	155,0	2	36027	1
23,5	276,0	155,0	3	36028	1
24,0	281,0	160,0	3	36029	1
24,5	281,0	160,0	3	36030	1
25,0	281,0	160,0	3	36031	1
25,5	286,0	165,0	3	36032	1
26,0	286,0	165,0	3	36033	1
26,5	286,0	165,0	3	36034	1
27,0	291,0	170,0	3	36035	1
27,5	291,0	170,0	3	36036	1
28,0	291,0	170,0	3	36037	1
28,5	296,0	175,0	3	36038	1
29,0	296,0	175,0	3	36039	1
29,5	296,0	175,0	3	36040	1
30,0	296,0	175,0	3	36041	1
30,5	301,0	180,0	3	36042	1
31,0	301,0	180,0	3	36043	1
31,5	301,0	180,0	3	36044	1
32,0	334,0	185,0	4	36045	1
32,5	334,0	185,0	4	36046	1

Ø	L1	L2		HSS-G	
				Code	Stk. pcs.
33,0	334,0	185,0	4	36047	1
33,5	334,0	185,0	4	36048	1
34,0	339,0	190,0	4	36049	1
34,5	339,0	190,0	4	36050	1
35,0	339,0	190,0	4	36051	1
35,5	339,0	190,0	4	36052	1
36,0	344,0	195,0	4	36053	1
36,5	344,0	195,0	4	36054	1
37,0	344,0	195,0	4	36055	1
37,5	344,0	195,0	4	36056	1
38,0	349,0	200,0	4	36057	1
38,5	349,0	200,0	4	36058	1
39,0	349,0	200,0	4	36059	1
39,5	349,0	200,0	4	36060	1
40,0	349,0	200,0	4	36061	1
40,5	354,0	205,0	4	36062	1
41,0	354,0	205,0	4	36063	1
41,5	354,0	205,0	4	36064	1
42,0	354,0	205,0	4	36065	1
42,5	354,0	205,0	4	36066	1
43,0	359,0	210,0	4	36067	1
43,5	359,0	210,0	4	36068	1
44,0	359,0	210,0	4	36069	1

Ø	L1	L2		HSS-G	
				Code	Stk. pcs.
44,5	359,0	210,0	4	36070	1
45,0	359,0	210,0	4	36071	1
45,5	364,0	215,0	4	36072	1
46,0	364,0	215,0	4	36073	1
46,5	364,0	215,0	4	36074	1
47,0	364,0	215,0	4	36075	1
47,5	364,0	215,0	4	36076	1
48,0	369,0	220,0	4	36077	1
48,5	369,0	220,0	4	36078	1
49,0	369,0	220,0	4	36079	1
49,5	369,0	220,0	4	36080	1
50,0	369,0	220,0	4	36081	1
51,0	412,0	225,0	5	36082	1
52,0	412,0	225,0	5	36083	1
53,0	412,0	225,0	5	36084	1
54,0	417,0	230,0	5	36085	1
55,0	417,0	230,0	5	36086	1
56,0	417,0	230,0	5	36087	1
57,0	422,0	235,0	5	36088	1
58,0	422,0	235,0	5	36089	1
59,0	422,0	235,0	5	36090	1
60,0	422,0	235,0	5	36091	1





Spiralbohrer | Twist Drills DIN 345 | Typ N | HSSE-Co 5

HSSE Co 5	DIN 345	N	6xD	118°	20-30°	Form A	
------------------	----------------	----------	-----	------	--------	--------	--

Leistungstarker Standardbohrer mit Morsekegel zum Bohren von legiertem und unlegiertem Stahl, Stahlguss und Gusseisen. Er weist eine hohe Bruchsicherheit auf.

Highly efficient standard drill with morse taper. For drilling steel, cast steel and cast iron – alloyed and unalloyed. Highly secure against fracture.

HSSE Co 5

< 850 N/mm ²	< 1100 N/mm ²	< 1300 N/mm ²	INOX < 850 N/mm ²	INOX > 850 N/mm ²	Grauguss Cast iron	Ti	Cu	Ms	Al	
●	●		○		○		○	○	○	○

● empfohlen | recommended ○ bedingt geeignet | partly suitable

Ø	L1	L2		HSSE-Co 5	
				Code	Stk. pcs.
10,0	168,0	87,0	1	36101	1
10,5	168,0	87,0	1	36102	1
11,0	175,0	94,0	1	36103	1
11,5	175,0	94,0	1	36104	1
12,0	182,0	101,0	1	36105	1
12,5	182,0	101,0	1	36106	1
13,0	182,0	101,0	1	36107	1
13,5	189,0	108,0	1	36108	1
14,0	189,0	108,0	1	36109	1
14,5	212,0	114,0	2	36110	1
15,0	212,0	114,0	2	36111	1
15,5	218,0	120,0	2	36112	1
16,0	218,0	120,0	2	36113	1
16,5	223,0	125,0	2	36114	1
17,0	223,0	125,0	2	36115	1
17,5	228,0	130,0	2	36116	1
18,0	228,0	130,0	2	36117	1
18,5	233,0	135,0	2	36118	1
19,0	233,0	135,0	2	36119	1
19,5	238,0	140,0	2	36120	1
20,0	238,0	140,0	2	36121	1
20,5	243,0	145,0	2	36122	1
21,0	243,0	145,0	2	36123	1
21,5	248,0	150,0	2	36124	1
22,0	248,0	150,0	2	36125	1
22,5	253,0	155,0	2	36126	1
23,0	253,0	155,0	2	36127	1

Ø	L1	L2		HSSE-Co 5	
				Code	Stk. pcs.
23,5	276,0	155,0	3	36128	1
24,0	281,0	160,0	3	36129	1
24,5	281,0	160,0	3	36130	1
25,0	281,0	160,0	3	36131	1
25,5	286,0	165,0	3	36132	1
26,0	286,0	165,0	3	36133	1
26,5	286,0	165,0	3	36134	1
27,0	291,0	170,0	3	36135	1
27,5	291,0	170,0	3	36136	1
28,0	291,0	170,0	3	36137	1
28,5	296,0	175,0	3	36138	1
29,0	296,0	175,0	3	36139	1
29,5	296,0	175,0	3	36140	1
30,0	296,0	175,0	3	36141	1

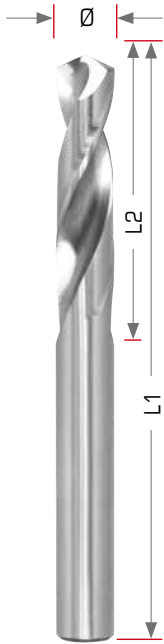

Spiralbohrer | Twist Drills
DIN 1897 | Typ N | HSS-G
kurz | short

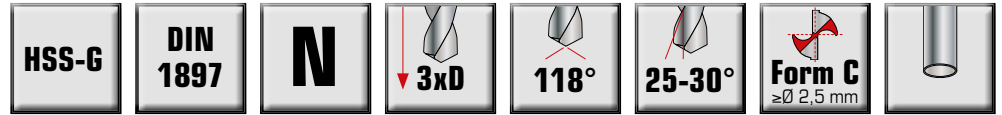

Kurzer und stabiler Spiralbohrer mit ausgeprägter Warmhärtebeständigkeit, der ideal geeignet ist für Montagearbeiten in dünnwandigen Materialien wie z.B. Blechen, Flach- und Profi leisen im Karosseriebau. Einsatzmöglichkeit in Handbohrmaschinen, auf Automaten und Revolverbänken.

Short and stable twist drill with distinctive heat resistance. Ideally suited for assembly work with thin-walled materials such as sheet steels, flat steels and profile steel in bodyshell construction. Use in hand-held drilling machines, with automatic machines and with turret lathes.

HSS-G

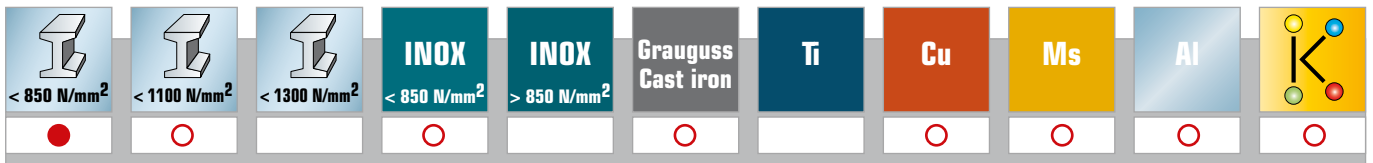

● empfohlen | recommended ○ bedingt geeignet | partly suitable

Ø	L1	L2	HSS-G	
			Code	Stk. pcs.
2,0	38,0	12,0	36401	10
2,5	43,0	14,0	36406	10
3,0	46,0	16,0	36411	10
3,3	49,0	18,0	36414	10
3,5	52,0	20,0	36416	10
4,0	55,0	22,0	36421	10
4,2	55,0	22,0	36423	10
4,5	58,0	24,0	36426	10
5,0	62,0	26,0	36431	10
5,5	66,0	28,0	36436	10
6,0	66,0	28,0	36441	10
6,5	70,0	31,0	36446	10
6,8	74,0	34,0	36449	10
7,0	74,0	34,0	36451	10
7,5	74,0	34,0	36456	10
8,0	79,0	37,0	36461	10
8,5	79,0	37,0	36462	10
9,0	84,0	40,0	36463	10
9,5	84,0	40,0	36464	10
10,0	89,0	43,0	36465	10
10,2	89,0	43,0	36466	10
10,5	89,0	43,0	36467	5
11,0	95,0	47,0	36468	5
11,5	95,0	47,0	36469	5
12,0	102,0	51,0	36470	5
12,5	102,0	51,0	36399	5
13,0	102,0	51,0	36400	5

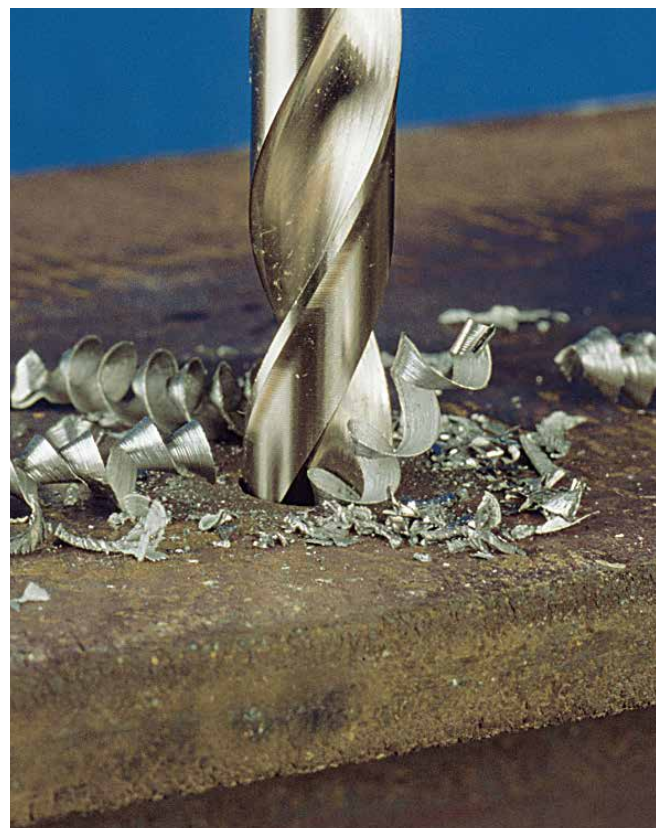

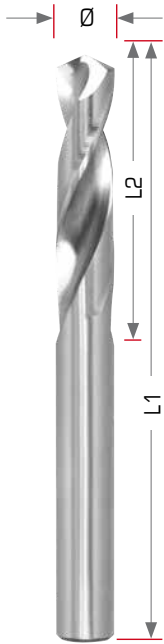

**HSSE
Co 5**

Spiralbohrer | **Twist Drills** DIN 1897 | Typ N | **HSSE-Co 5** kurz | **short**

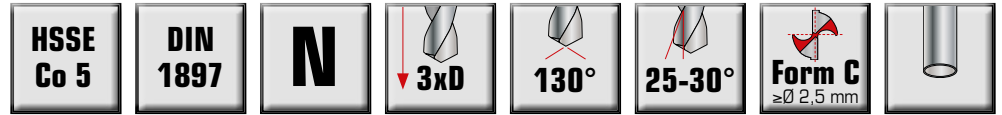

Kurzer und stabiler Spiralbohrer mit ausgeprägter Warmhärtebeständigkeit, der ideal geeignet ist für Montagearbeiten in dünnwandigen Materialien wie z.B. Blechen, Flach- und Profilleisen im Karosseriebau. Einsatzmöglichkeit in Handbohrmaschinen, auf Automaten und Revolverbänken.

Short and stable twist drill with distinctive heat resistance. Ideally suited for assembly work with thin-walled materials such as sheet steels, flat steels and profile steel in bodyshell construction. Use in hand-held drilling machines, with automatic machines and with turret lathes.

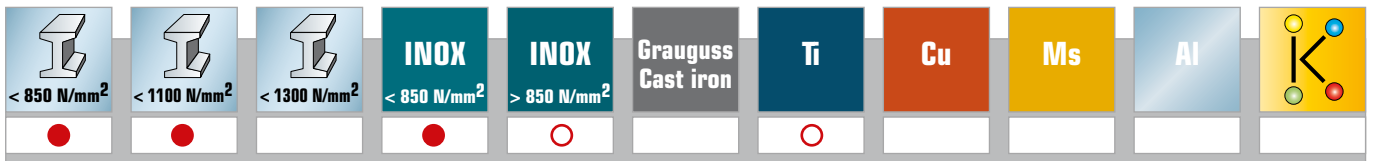

● empfohlen | recommended ○ bedingt geeignet | partly suitable

Ø	L1	L2	HSSE-Co 5	
			Code	Stk. pcs.
2,0	38,0	12,0	36471	10
2,5	43,0	14,0	36472	10
3,0	46,0	16,0	36473	10
3,3	49,0	18,0	36476	10
3,5	52,0	20,0	36478	10
4,0	55,0	22,0	36482	10
4,2	55,0	22,0	36484	10
4,5	58,0	24,0	36487	10
5,0	62,0	26,0	36491	10
5,5	66,0	28,0	36494	10
6,0	66,0	28,0	36498	10
6,5	70,0	31,0	36499	10
6,8	74,0	34,0	36500	10
7,0	74,0	34,0	36501	10
7,5	74,0	34,0	36502	10
8,0	79,0	37,0	36503	10
8,5	79,0	37,0	36504	10
9,0	84,0	40,0	36505	10
9,5	84,0	40,0	36506	10
10,0	89,0	43,0	36507	10
10,2	89,0	43,0	36508	10
10,5	89,0	43,0	36509	5
11,0	95,0	47,0	36510	5
11,5	95,0	47,0	36511	5
12,0	102,0	51,0	36512	5
12,5	102,0	51,0	36513	5
13,0	102,0	51,0	36514	5

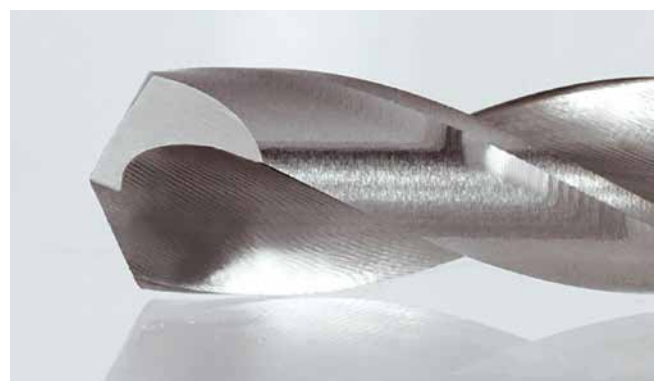

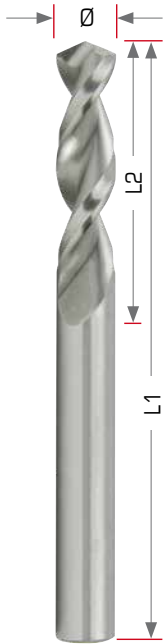

**HSSE
Co 5**

Spiralbohrer | Twist Drills
DIN 1897 | Typ UF-L | HSSE-Co 5
kurz | short

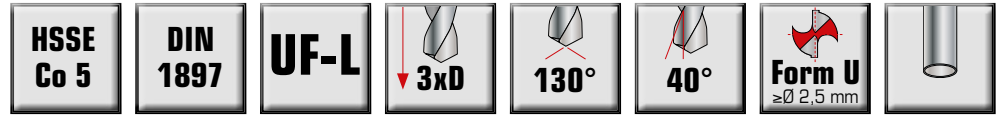

Kurzer und sehr stabiler Mehrbereichsbohrer mit hervorragender Warmhärtebeständigkeit mit spezieller Geometrie zur Optimierung von Spanbildung und Spanabfuhr. Er ist ideal geeignet für Montagearbeiten in dünnwandigen Materialien wie z.B. Blechen, Flach- und Profileisen aus mittel- und langspanenden Werkstoffen.

Short and highly stable multirange drill with outstanding heat resistance and special geometry for optimising chip formation and removal. Ideally suited for assembly work in thin-walled materials such as sheet steels, flat steel and profile steel comprising of medium and long-chipping materials.

 < 850 N/mm ²	 < 1100 N/mm ²	 < 1300 N/mm ²	INOX < 850 N/mm ²	INOX > 850 N/mm ²	Grauguss Cast iron	Ti	Cu	Ms	Al	
●	○		○		○		○	○	○	○

● empfohlen | recommended ○ bedingt geeignet | partly suitable

Ø	L1	L2	HSSE-Co 5	
			Code	Stk. pcs.
2,0	38,0	12,0	36535	10
2,5	43,0	14,0	36536	10
3,0	46,0	16,0	36537	10
3,3	49,0	18,0	36538	10
3,5	52,0	20,0	36539	10
4,0	55,0	22,0	36540	10
4,2	55,0	22,0	36541	10
4,5	58,0	24,0	36542	10
5,0	62,0	26,0	36543	10
5,5	66,0	28,0	36544	10
6,0	66,0	28,0	36545	10
6,5	70,0	31,0	36546	10
6,8	74,0	34,0	36547	10
7,0	74,0	34,0	36548	10
7,5	74,0	34,0	36549	10
8,0	79,0	37,0	36550	10
8,5	79,0	37,0	36551	10
9,0	84,0	40,0	36552	10
9,5	84,0	40,0	36553	10
10,0	89,0	43,0	36554	10
10,2	89,0	43,0	36555	10
10,5	89,0	43,0	36556	5
11,0	95,0	47,0	36557	5
11,5	95,0	47,0	36558	5
12,0	102,0	51,0	36559	5
12,5	102,0	51,0	36560	5
13,0	102,0	51,0	36561	5



Spiralbohrer Sets | Sets of Twist Drills DIN 338 | Typ N | HSS-G

Spiralbohrer Set • Sets of Twist Drills



Technische Information Spiralbohrer HSS-G

Spitzenanschliff: Kegelmantelschliff • Spiralwinkel: 20 - 30°
Ø-Toleranz: h8 • rechtsschneidend

Technical Information Twist Drills HSS-G

Tip grinding: Cone envelope grinding • Spiral angle: 20 - 30°
Diameter tolerance: h8 • clockwise-cutting

INHALT	HSS-G	
	Code	Stk. pcs.
19 tlg. pcs. DIN 338 Typ N Ø 1,0 mm – 10,0 mm x 0,5 mm steigend in steps	73161	1
25 tlg. pcs. DIN 338 Typ N Ø 1,0 mm – 13,0 mm x 0,5 mm steigend in steps	73162	1



Technische Information VAP (Vaporisieren)

Aufdampfen einer nicht metallischen Oxydschicht – wirkt als Trennschicht und vermindert Kaltaufschweißung.

Technical Information VAP (Vaporisation)

Steam tamping process – the nonferrous oxide film reduces cold-welding.

INHALT	HSS-G	
	Code	Stk. pcs.
19 tlg. pcs. DIN 338 Typ N Ø 1,0 mm – 10,0 mm x 0,5 mm steigend in steps	73561	1
25 tlg. pcs. DIN 338 Typ N Ø 1,0 mm – 13,0 mm x 0,5 mm steigend in steps	73562	1



Technische Information TIN-Beschichtung

Die Titan-Nitrid-Beschichtung erhöht die Werkzeugstandzeiten und ermöglicht höhere Schnittgeschwindigkeiten.

Technical Information TIN Coating

The titanium nitride coating increases the tool life and allows higher cutting speeds.

INHALT	HSS-G	
	Code	Stk. pcs.
19 tlg. pcs. DIN 338 Typ N Ø 1,0 mm – 10,0 mm x 0,5 mm steigend in steps	73361	1
25 tlg. pcs. DIN 338 Typ N Ø 1,0 mm – 13,0 mm x 0,5 mm steigend in steps	73362	1

Spiralbohrer Sets | Sets of Twist Drills DIN 338 | Typ N | HSS-G



Technische Information TiAlN-Beschichtung

Spiralbohrer mit Titan-Aluminium-Beschichtung sind für besonders harte Materialien geeignet, ermöglichen höchste Schnittgeschwindigkeiten und benötigen kein Kühlmittel.

Technical Information TiAlN TIP Coating

Twist Drills with titanium-aluminum coating are suitable for particularly hard materials and does not require coolant.

INHALT	HSS-G	
	Code	Stk. pcs.
19 tlg. pcs. DIN 338 Typ N Ø 1,0 mm – 10,0 mm x 0,5 mm steigend in steps	72961	1
25 tlg. pcs. DIN 338 Typ N Ø 1,0 mm – 13,0 mm x 0,5 mm steigend in steps	72962	1



Technische Information TiN TIP-Beschichtung

Die Titan-Nitrid-Beschichtung im schneidaktiven Teil erhöht die Werkzeugstandzeiten und ermöglicht höhere Schnittgeschwindigkeiten sowie Vorschübe.

Technical Information TiN TIP Coating

The titanium nitride coating in the active cutting part increases the tool life and allows higher cutting speeds and feed rates.

INHALT	HSS-G	
	Code	Stk. pcs.
19 tlg. pcs. DIN 338 Typ N Ø 1,0 mm – 10,0 mm x 0,5 mm steigend in steps	73761	1
25 tlg. pcs. DIN 338 Typ N Ø 1,0 mm – 13,0 mm x 0,5 mm steigend in steps	73762	1



Technische Information TiAlN TIP-Beschichtung

Die Titan-Aluminium-Beschichtung im schneidaktiven Teil ist für besonders harte Materialien geeignet und benötigt kein Kühlmittel.

Technical Information TiAlN TIP Coating

The titanium-aluminum coating in the active cutting part is suitable for particularly hard materials and does not require coolant.

INHALT	HSS-G	
	Code	Stk. pcs.
19 tlg. pcs. DIN 338 Typ N Ø 1,0 mm – 10,0 mm x 0,5 mm steigend in steps	73961	1
25 tlg. pcs. DIN 338 Typ N Ø 1,0 mm – 13,0 mm x 0,5 mm steigend in steps	73962	1

Spiralbohrer Sets | Sets of Twist Drills
DIN 338 | Typ VA | HSSE-Co 5

Spiralbohrer Set • Sets of Twist Drills



Technische Information

Der Kobaltanteil sorgt für eine höhere Wärmehärtebeständigkeit – Ideal zum Bohren von rost-, säure- und hitzebeständigem Stahl mit hoher Festigkeit.

Technical Information

High-performance drill with distinctive heat resistance. Ideal for drilling high-strength stainless, acid-resistant and heat-resistant steel.

INHALT	HSSE-Co 5	
	Code	Stk. pcs.
19 tlg. pcs. DIN 338 Typ N Ø 1,0 mm – 10,0 mm x 0,5 mm steigend l in steps	74161	1
25 tlg. pcs. DIN 338 Typ N Ø 1,0 mm – 13,0 mm x 0,5 mm steigend l in steps	74162	1

Spiralbohrer Sets | Sets of Twist Drills
DIN 338 | Typ VA | HSSE-Co 8



Technische Information

Kräftiger Sonderbohrer, der ideal für Titanlegierungen sowie rost-, säure- und hitzebeständigen austenitischen Stählen verwendbar ist.

Technical Information

Powerful special drill that should ideally be used for titanium base alloys as well as stainless, acid-resistant and heat-resistant austenitic steels.

INHALT	HSSE-Co 8	
	Code	Stk. pcs.
19 tlg. pcs. DIN 338 Typ N Ø 1,0 mm – 10,0 mm x 0,5 mm steigend l in steps	74761	1
25 tlg. pcs. DIN 338 Typ N Ø 1,0 mm – 13,0 mm x 0,5 mm steigend l in steps	74762	1

Spiralbohrer Sets | Sets of Twist Drills DIN 338 | Typ EX-TL | HSS-G



Technische Information

Sehr stabiler Mehrbereichsbohrer mit hervorragender Warmhärtebeständigkeit, verstärktem Bohrerkerne und einer parabolisch geformten Spannut zur idealen Spanabfuhr.

Technical Information

Highly stable multirange drill with outstanding heat resistance, a reinforced drill core and a parabolic flute for ideal chip removal.

INHALT	HSS-G	
	Code	Stk. pcs.
19 tlg. pcs. DIN 338 Typ N Ø 1,0 mm – 10,0 mm x 0,5 mm steigend in steps	75161	1
25 tlg. pcs. DIN 338 Typ N Ø 1,0 mm – 13,0 mm x 0,5 mm steigend in steps	75162	1

Spiralbohrer Sets | Sets of Twist Drills DIN 338 | Typ EX-TL | HSSE-Co 5



Technische Information

Sehr stabiler Mehrbereichsbohrer mit hervorragender Warmhärtebeständigkeit, verstärktem Bohrerkerne und einer parabolisch geformten Spannut zur idealen Spanabfuhr.

Technical Information

Highly stable multirange drill with outstanding heat resistance, a reinforced drill core and a parabolic flute for ideal chip removal.

INHALT	HSSE-Co 5	
	Code	Stk. pcs.
19 tlg. pcs. DIN 338 Typ N Ø 1,0 mm – 10,0 mm x 0,5 mm steigend in steps	75761	1
25 tlg. pcs. DIN 338 Typ N Ø 1,0 mm – 13,0 mm x 0,5 mm steigend in steps	75762	1

Spiralbohrer Sets | Sets of Twist Drills
DIN 338 | Typ UNI | HSS-G

Spiralbohrer Set • Sets of Twist Drills



Technische Information

Dieser Hochleistungsspiralbohrer ist speziell für den portablen Einsatz in Bohrmaschinen und Akku-Bohrschraubern entwickelt worden (beste Leistung bis 5,0 mm Materialstärke).

Technical Information

High performance twist drill for all-purpose use in drilling machines and cordless drills. (Materials up to 5,0 mm thickness)

INHALT	HSS-G	
	Code	Stk. pcs.
19 tlg. pcs. DIN 338 Typ N Ø 1,0 mm – 10,0 mm x 0,5 mm steigend in steps	76161	1
25 tlg. pcs. DIN 338 Typ N Ø 1,0 mm – 13,0 mm x 0,5 mm steigend in steps	76162	1

Spiralbohrer Sets | Sets of Twist Drills
DIN 338 | Typ UNI | HSSE-Co 5



Technische Information

Dieser Hochleistungsspiralbohrer ist speziell für den portablen Einsatz in Bohrmaschinen und Akku-Bohrschraubern entwickelt worden (beste Leistung bis 5,0 mm Materialstärke).

Technical Information

High performance twist drill for all-purpose use in drilling machines and cordless drills. (Materials up to 5,0 mm thickness)

INHALT	HSSE-Co 5	
	Code	Stk. pcs.
19 tlg. pcs. DIN 338 Typ N Ø 1,0 mm – 10,0 mm x 0,5 mm steigend in steps	76361	1
25 tlg. pcs. DIN 338 Typ N Ø 1,0 mm – 13,0 mm x 0,5 mm steigend in steps	76362	1

Spiralbohrer | **Twist Drills** **DIN 338 | HSSE-Co 5**

mit ROTASTOP®-Schaft | ROTASTOP®-Shank



Technische Information

Dieser Hochleistungsspiralbohrer ist speziell für den portablen Einsatz in Bohrmaschinen und Akku-Bohrschraubern entwickelt worden (beste Leistung bis 5,0 mm Materialstärke).

Technical Information

High performance twist drill for all-purpose use in drilling machines and cordless drills. (Materials up to 5,0 mm thickness)

INHALT	HSSE-Co 5	
	Code	Stk. pcs.
19 tlg. pcs. DIN 338 Typ N Ø 1,0 mm – 10,0 mm x 0,5 mm steigend in steps	76561	1
25 tlg. pcs. DIN 338 Typ N Ø 1,0 mm – 13,0 mm x 0,5 mm steigend in steps	76562	1



Verwendung der Bohrer & Schneidbedingungen

Application of drills and cutting conditions

Material	Empfohlene Anwendung Recommended for use		Kühlung Cooling	Schnittgeschwindigkeit Cutting speed v (m/min)	Bohrerdurchmesser d (mm) Drill diameter d (mm)				
	Hauptvorschlag Main suggestion	Alternativvorschlag Other suggestion			2	4	6	9	12
	Seite Page	Seite Page			Vorschub f (mm/Umdrehung) Feed rate f (mm/rotation)				
Automatenstahl 350-500 N/mm ² Free cutting steel 350-500 N/mm ²	12	22 / 33	E	30-40	0,05	0,1	0,125	0,16	0,2
Automatenstahl 500-900 N/mm ² Free cutting steel 500-900 N/mm ²	12	24 / 33	E	25-30	0,04	0,08	0,1	0,125	0,16
Baustahl bis 500 N/mm ² Structural steel up to 500 N/mm ²	12	22 / 33	E	30-40	0,04	0,08	0,1	0,125	0,16
Baustahl 500-900 N/mm ² Structural steel 500-900 N/mm ²	12	24 / 33	E	20-25	0,032	0,063	0,08	0,1	0,125
Unlegierter Einsatzstahl bis 600 N/mm ² Plain carbon case hardening steel up to 600 N/mm ²	12	22 / 33	E	25-35	0,05	0,1	0,125	0,16	0,2
Legierter Einsatzstahl 500-900 N/mm ² Alloyed case hardening steel 500-900 N/mm ²	12	24 / 33		20-25	0,4	0,08	0,1	0,125	0,16
Legierter Einsatzstahl 900-1200 N/mm ² Alloyed case hardening steel 900-1000 N/mm ²	17	34	E, O	10-15	0,025	0,05	0,063	0,08	0,1
Nitrierstahl 700-900 N/mm ² Nitriding steel 700-900 N/mm ²	17	24 / 34	E	15-20	0,032	0,063	0,08	0,1	0,125
Vergüteter Nitrierstahl 800-1250 N/mm ² Heat treated nitriding steel 800-1250 N/mm ²	17	25	E, O	8-12	0,025	0,05	0,063	0,08	0,1
Weichstahl zur Vergütung 500-750 N/mm ² Mild steel for heat treatment 500-750 N/mm ²	12	24 / 33	E	25-35	0,04	0,08	0,1	0,125	0,16
Unlegierter Einsatzstahl zur Vergütung 700-1000 N/mm ² Plain carbon steel for heat treatment 700-1000 N/mm ²	17	25 / 35	E	15-20	0,04	0,08	0,1	0,125	0,16
Legierter Stahl zur Vergütung 900-1250 N/mm ² Alloyed steel heat treatment 900-1250 N/mm ²	17	25 / 35	E, O	10-15	0,032	0,063	0,08	0,1	0,125
Manganstahl mit einem Gehalt über 10 % Mn Manganese steel with content over 10 % Mn	17	34	E, O	3-6	0,2	0,04	0,063	0,08	0,1
Unlegierter Werkzeugstahl 700-900 N/mm ² Plain carbon tool steel 700-900 N/mm ²	17	25 / 34	E	14-18	0,032	0,063	0,08	0,1	0,12
Legierter Werkzeugstahl 850-1250 N/mm ² Alloyed tool steel 850-1250 N/mm ²	17	25	E, O	8-12	0,025	0,05	0,063	0,08	0,1
Hitzebeständiger Stahl 450-600 N/mm ² Heat resistant steel 450-600 N/mm ²	17	-	O	15-20	0,032	0,063	0,08	0,1	0,125
Rostfreie Stähle Stainless steel	15	17	E, O	6-10	0,02	0,032	0,05	0,08	0,1
Legierungen Hastelloy, Inconel, Nimonic Alloys hastelloy, inconel, nimonic	17	-	O	3-6	0,02	0,04	0,063	0,08	0,125
Grauguß HB 180-240 Grey cast iron HB 180-240	12	24	E, DL	30-40	0,05	0,1	0,125	0,16	0,2
Grauguß HB 240-300 Grey cast iron HB 240-300	12	24	E, DL	20-30	0,05	0,1	0,125	0,16	0,2
Temperguß HB 180-240 Malleable cast iron HB 180-240	12	24	DL	20-30	0,05	0,1	0,125	0,16	0,2
Aluminium Aluminium	22	-	E	50-80	0,05	0,1	0,125	0,16	0,2
Alu. Legierungen m. e. Gehalt bis 10 % Si u. 180 N/mm ² Aluminium alloys with content up to 10 % Si and 180 N/mm ²	22	-	E	40-65	0,063	0,1255	0,16	0,2	0,25
Alu. Legierungen / Gehalt bis 10 % Si u. 150-250 N/mm ² Aluminium alloys with content up to 10 % Si and 150-250 N/mm ²	12	-	E	30-50	0,063	0,1255	0,16	0,2	0,25
Kupfer 200-400 N/mm ² Copper 200-400 N/mm ²	24	-	E, O	30-40	0,05	0,1	0,125	0,16	0,2
Sprödes Messing mit kurzem Span 350-550 N/mm ² Fragile brass with short chip 350-550 N/mm ²	17	33	E, O	60-80	0,063	0,1255	0,16	0,2	0,25
Bronze 500-800 N/mm ² Bronze 500-800 N/mm ²	12	22	E, O	15-30	0,05	0,08	0,125	0,16	0,2
Magnesiumlegierungen-Elektron Magnesium alloys-electron	17	-	-	60-100	0,08	0,125	0,016	0,02	0,25
Zink, Zinklegierungen Zinc, zinc alloys	12	22	E	35-45	0,05	0,1	0,125	0,16	0,2
Titanlegierungen bis 700 N/mm ² Titanium alloys up to 700 N/mm ²	17	-	O	3-6	0,03	0,05	0,063	0,08	0,1
Titanlegierungen 700-1000 N/mm ² Titanium alloys 700-1000 N/mm ²	17	-	O	3-6	0,02	0,04	0,05	0,063	0,08
Silber Silver	12	22	E	30-40	0,05	0,08	0,1	0,125	0,16
Duromeren Duroplastics	17	-	DL	10-20	0,04	0,08	0,1	0,125	0,16

E = Emulsion / O = Schneidöl / DL = Druckluft / W = Wasser | E = emulsion / O = cutting oil / CA = compressed air / W = water

Bohrer Drills Ø mm	Schnittgeschwindigkeit Vc = m/min Cutting speed Vc = m/min															
	4	6	8	10	12	15	18	20	25	30	35	40	50	60	80	100
	Drehzahl U/min r.p.m.															
1,0	1274	1911	2548	3185	3822	4777	5732	6369	7962	9554	11146	12739	15924	19108	25478	31847
1,5	849	1274	1699	2123	2548	3185	3822	4246	5308	6369	7431	8493	10616	12739	16985	21231
2,0	637	955	1274	1592	1911	2389	2866	3185	3981	4777	5573	6369	7962	9554	12739	15924
2,5	510	764	1019	1274	1529	1911	2293	2548	3185	3822	4459	5096	6369	7643	10191	12739
3,0	425	637	849	1062	1274	1592	1911	2123	2654	3185	3715	4246	5308	6369	8493	10616
3,5	364	546	728	910	1092	1365	1638	1820	2275	2730	3185	3640	4550	5460	7279	9099
4,0	318	478	637	796	955	1194	1433	1592	1990	2389	2787	3185	3981	4777	6369	7962
4,5	283	425	566	708	849	1062	1274	1415	1769	2123	2477	2831	3539	4246	5662	7077
5,0	255	382	510	637	764	955	1146	1274	1592	1911	2229	2548	3185	3822	5096	6369
5,5	232	347	463	579	695	869	1042	1158	1448	1737	2027	2316	2895	3474	4632	5790
6,0	212	318	425	531	637	796	955	1062	1327	1592	1858	2123	2654	3185	4246	5308
6,5	196	294	392	490	588	735	882	980	1225	1470	1715	1960	2450	2940	3920	4900
7,0	182	273	364	455	546	682	819	910	1137	1365	1592	1820	2275	2730	3640	4550
7,5	170	255	340	425	510	637	764	849	1062	1274	1486	1699	2123	2548	3397	4246
8,0	159	239	318	398	478	597	717	796	995	1194	1393	1592	1990	2389	3185	3981
8,5	150	225	300	375	450	562	674	749	937	1124	1311	1499	1873	2248	2997	3747
9,0	142	212	283	354	425	531	637	708	885	1062	1238	1415	1769	2123	2831	3539
9,5	134	201	268	335	402	503	603	670	838	1006	1173	1341	1676	2011	2682	3352
10,0	127	191	255	318	382	478	573	637	796	955	1115	1274	1592	1911	2548	3185
11,0	116	174	232	290	347	434	521	579	724	869	1013	1158	1448	1737	2316	2895
12,0	106	159	212	265	318	398	478	531	663	796	929	1062	1327	1592	2123	2654
13,0	98	147	196	245	294	367	441	490	612	735	857	980	1225	1470	1960	2450
14,0	91	136	182	227	273	341	409	455	569	682	796	910	1137	1365	1820	2275
15,0	85	127	170	212	255	318	382	425	531	637	743	849	1062	1274	1699	2123
16,0	80	119	159	199	239	299	358	398	498	597	697	796	995	1194	1592	1990
17,0	75	112	150	187	225	281	337	375	468	562	656	749	937	1124	1499	1873
18,0	71	106	142	177	212	265	318	354	442	531	619	708	885	1062	1415	1769
19,0	67	101	134	168	201	251	302	335	419	503	587	670	838	1006	1341	1676
20,0	64	96	127	159	191	239	287	318	398	478	557	637	796	955	1274	1592
21,0	61	91	121	152	182	227	273	303	379	455	531	607	758	910	1213	1517
22,0	58	87	116	145	174	217	261	290	362	434	507	579	724	869	1158	1448
23,0	55	83	111	138	166	208	249	277	346	415	485	554	692	831	1108	1385
24,0	53	80	106	133	159	199	239	265	332	398	464	531	663	796	1062	1327
25,0	51	76	102	127	153	191	229	255	318	382	446	510	637	764	1019	1274
26,0	49	73	98	122	147	184	220	245	306	367	429	490	612	735	980	1225
27,0	47	71	94	118	142	177	212	236	295	354	413	472	590	708	944	1180
28,0	45	68	91	114	136	171	205	227	284	341	398	455	569	682	910	1137
29,0	44	66	88	110	132	165	198	220	275	329	384	439	549	659	879	1098
30,0	42	64	85	106	127	159	191	212	265	318	372	425	531	637	849	1062
31,0	41	62	82	103	123	154	185	205	257	308	360	411	514	616	822	1027
32,0	40	60	80	100	119	149	179	199	249	299	348	398	498	597	796	995
33,0	39	58	77	97	116	145	174	193	241	290	338	386	483	579	772	965
34,0	37	56	75	94	112	141	169	187	234	281	328	375	468	562	749	937
35,0	36	55	73	91	109	136	164	182	227	273	318	364	455	546	728	910
36,0	35	53	71	88	106	133	159	177	221	265	310	354	442	531	708	885
37,0	34	52	69	86	103	129	155	172	215	258	301	344	430	516	689	861
38,0	34	50	67	84	101	126	151	168	210	251	293	335	419	503	670	838
39,0	33	49	65	82	98	122	147	163	204	245	286	327	408	490	653	817
40,0	32	48	64	80	96	119	143	159	199	239	279	318	398	478	637	796
41,0	31	47	62	78	93	117	140	155	194	233	272	311	388	466	621	777
42,0	30	45	61	76	91	114	136	152	190	227	265	303	379	455	607	758
43,0	30	44	59	74	89	111	133	148	185	222	259	296	370	444	593	741
44,0	29	43	58	72	87	109	130	145	181	217	253	290	362	434	579	724
45,0	28	42	57	71	85	106	127	142	177	212	248	283	354	425	566	708
46,0	28	42	55	69	83	104	125	138	173	208	242	277	346	415	554	692
47,0	27	41	54	68	81	102	122	136	169	203	237	271	339	407	542	678
48,0	27	40	53	66	80	100	119	133	166	199	232	265	332	398	531	663
49,0	26	39	52	65	78	97	117	130	162	195	227	260	325	390	520	650
50,0	25	38	51	64	76	96	115	127	159	191	223	255	318	382	510	637

Werkstoff Material	Schnittgeschw. Cutting speed Vc m/min	Kühl- schmierstoff Coolant	Werkstoff Material	Schnittgeschw. Cutting speed Vc m/min	Kühl- schmierstoff Coolant
unlegierte Baustähle < 700 N/mm²	30 - 35	Schneidspray Cutting spray	CuZn-Legierungen zäh CuZn alloy tough	35 - 60	Druckluft Compresses air
legierte Baustähle > 700 N/mm²	20 - 25		Al-Legierungen bis 11 % Si Al alloy 11% Si	30 - 50	Schneid-/Cuttingspray
legierte Stähle Alloyed steel < 1000 N/mm²	20 - 25		Thermoplaste Thermoplastics	20 - 40	Wasser water
Gußeisen Cast iron < 250 N/mm²	15 - 25	Druckluft Compresses air	Duroplaste mit anorgan. Füllung Duroplastics	15 - 25	Druckluft
Gußeisen Cast iron > 250 N/mm²	10 - 20		Duroplaste mit organ. Füllung Duroplastics	15 - 35	Compresses air
CuZn-Legierungen spröde CuZn alloy brittle	60 - 100				

Zusatzartikel • Additional products

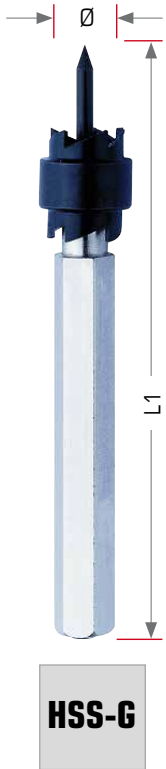

Schweißpunktfräser Weld Point Milling Bit | HSS-G

HSS-G

Zum Lösen von punktgeschweißten Blechteilen. Die Fräser sind beidseitig schneidend und auswechselbar. Die Frästiefe ist durch eine Schraube einstellbar. Keine Deformierung des Bleches.

For removing spot welds from sheet metal. Exchangeable and double-headed milling crown. Adjustable milling depth with setting screw. No tearing of the sheet metal. No deformation of the sheet metal.

	Ø	L1	HSS-G	
			Code	Stk. pcs.
	10,0	72,0	50501	1
Ersatzkrone Milling crown	9,6		50506	1
Ersatzstift Centering pin	2,5		50505	1

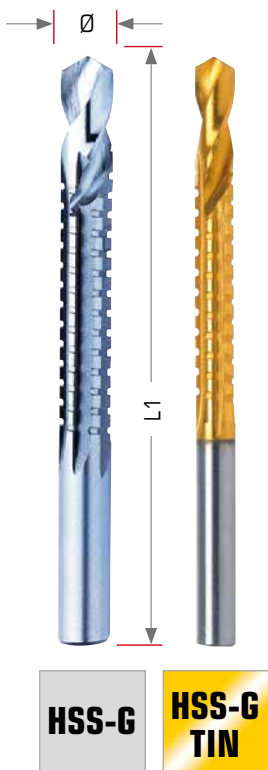

Fräsbohrer | Milling Drill HSS-G



Zum Bohren und Fräsen in Holz, Blech, Plastik und anderen dünnwandigen Materialien.

For drilling and milling contours into wood, sheet metal, plastics and other thin-walled materials.

Ø	L1	HSS-G		HSS-G	
		Code	Stk. pcs.	Code	Stk. pcs.
6,0	90,0	5381	1	50779	1
8,0	90,0	5382	1	50780	1



Schweißpunktbohrer Welding Spot Drill | HSS-G

HSS-G	DIN 1897	180°	25-30°
--------------	-----------------	-------------	---------------

Besonders geeignet zum Ausbohren von Schweißpunkten und zum Bohren dünnwandiger Werkstücke. Extrem hohe Präzision und gratfreies Bohren ohne Ankörnen. Zum Bohren von Stahlblech, Messingblech, Aluminiumblech, Zinkblech, Kupferblech, Kunststoffplatten.

Good suited for clean and burr-free milling of welding spots and thin-walled work pieces without centering. Extreme high precision. Applicable for sheet steel, sheet brass, sheet aluminium, sheet zinc, sheet copper, plastic sheets.

< 850 N/mm²	< 1100 N/mm²
● empfohlen recommended	○ bedingt geeignet partly suitable

Ø	L1	HSS-G	
		Code	Stk. pcs.
6,0	66,0	50507	1
8,0	80,0	50508	1

● empfohlen | recommended
○ bedingt geeignet | partly suitable

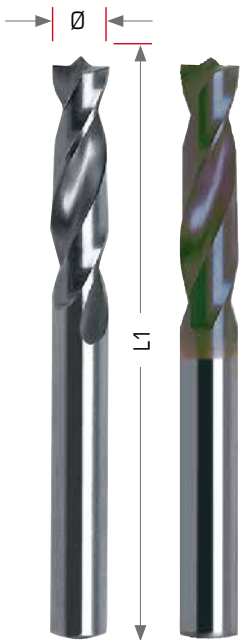

Schweißpunktbohrer Welding Spot Drill | HSSE-Co 5

HSSE Co 5	DIN 1897	180°	25-30°
------------------	-----------------	-------------	---------------

Besonders geeignet zum Ausbohren von Schweißpunkten und zum Bohren dünnwandiger Werkstücke. Extrem hohe Präzision und gratfreies Bohren ohne Ankörnen. Zum Bohren von Stahlblech, Messingblech, Aluminiumblech, Zinkblech, Kupferblech, Kunststoffplatten. Die TiCN Beschichtung ist besonders geeignet für aufschmierende Werkstoffe wie Aluminium und VA.

Good suited for clean and burr-free milling of welding spots and thin-walled work pieces without centering. Extreme high precision. Applicable for sheet steel, sheet brass, sheet aluminium, sheet zinc, sheet copper, plastic sheets. The TiCN coating has good attitudes at greasy materials like Aluminium and VA (Stainless Steel).

HSSE Co 5	HSSE Co 5 TiCN
------------------	-----------------------

< 850 N/mm²	< 1100 N/mm²	< 1300 N/mm²	INOX < 850 N/mm²
● empfohlen recommended	● empfohlen recommended	○ bedingt geeignet partly suitable	○ bedingt geeignet partly suitable

Ø	L1	HSSE-Co 5		HSSE-Co 5	
		Code	Stk. pcs.	Code	Stk. pcs.
6,0	66,0	05383	1	50777	1
7,0	74,0	05391	1		
8,0	80,0	05384	1	50778	1
10,0	88,0	05392	1	50769	1

● empfohlen | recommended ○ bedingt geeignet | partly suitable

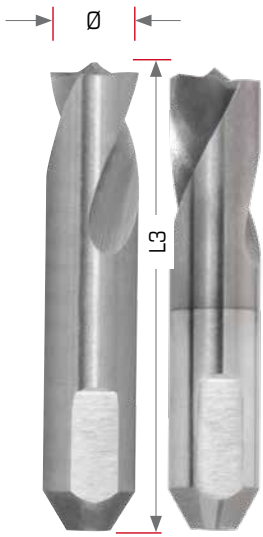

Schweißpunktbohrer Spotle Drill

Spotle Drill | HSSE-Co 5



Spezial-Schaftanfasung für den Einsatz in Pneumatikmaschinen. Für saubere und gratfreie Ausbohrungen von Schweißpunkten. Extrem hohe Präzision und gratfreies Bohren ohne Ankörnen. Die TiCN Beschichtung ist besonders geeignet für aufschmierende Werkstoffe wie Aluminium und VA.



Special shank for the application in pneumatic machines. For clean and burr-free milling of welding spots and thin-walled work pieces without centering. Extreme high precision. The TiCN coating has good attitudes at greasy materials like Aluminium and VA (Stainless Steel).





 < 850 N/mm ² ●	 < 1100 N/mm ² ●	 < 1300 N/mm ² ○	INOX < 850 N/mm ² ○
----------------------------------	-----------------------------------	-----------------------------------	---

● empfohlen | recommended ○ bedingt geeignet | partly suitable

Ø	L3	HSSE-Co 5		HSSE-Co 5	
		Code	Stk. pcs.	Code	Stk. pcs.
6,5	40,0	05395	1		
8,0	40,0	05396	1	05397	1
8,0	44,0	05398	1	05399	1

Anwendung
EVENTUS by EXACT Spiralbohrer
Application
EVENTUS by EXACT Twist Drills



Norm Standard	DIN 338	DIN 338	DIN 338	DIN 338	DIN 338	DIN 340	DIN 345
Typ Type	N	N	N	N	N	N	N
Bohrtiefe Depth of drilling	5xD	5xD	5xD	5xD	5xD	10xD	6xD
Beschichtung Coating				TIN			
Werkstoff Steel grade	HSS-R	HSS-R	HSS-G	HSS-G	HSSE-Co 5	HSS-R	HSS-R
Spitzenwinkel Point angle	118°	118°	118°	118°	130°	118°	118°
Ø mm	1,0 - 16,0	10,5 - 25,0	0,3 - 16,0	0,3 - 16,0	1,0 - 16,0	1,0 - 13,0	10,0 - 50,0
Seite Page	292-293	294	295-297	295-297	298-299	300	301-302
Geeignet für Suitable for							
 < 850 N/mm²	Stähle < 850 N/mm ² Steels < 850 N/mm ²	●	●	●	●	●	●
 < 1100 N/mm²	Stähle < 1100 N/mm ² Steels < 1100 N/mm ²			○	○	●	
 < 1300 N/mm²	Stähle < 1300 N/mm ² Steels < 1300 N/mm ²						
INOX < 850 N/mm²	Rostfreie Stähle < 850 N/mm ² Stainless steels < 850 N/mm ²			○	○	●	
INOX > 850 N/mm²	Rostfreie Stähle > 850 N/mm ² Stainless steels > 850 N/mm ²					○	
Grauguss Cast iron	Grauguss, Temperguss Cast iron, malleable cast iron	●	●	●	●	○	●
Ti	Titan- und Titanlegierungen Titanium and titanium alloys						
Cu	Kupfer Copper	○	○	○	○	○	○
Ms	Messing Brass	○	○	○	○	○	○
Al	Aluminium Aluminium			○			
 K	Kunststoffe Plastics			○	○		

● empfohlen | recommended ○ bedingt geeignet | partly suitable



Spiralbohrer | Twist Drills DIN 338 | Typ N | HSS-R

HSS-R	DIN 338	N	5xD	118°	25-30°	Form N	
--------------	----------------	----------	-----	------	--------	--------	--

Dieser leistungsstarke, rollgewalzte Spiralbohrer aus Hochleistungs-Schnellarbeitsstahl bietet durch das rollgewalzte Herstellungsverfahren, bei dem der Werkstoff verfestigt wird, eine erhöhte Bruchsicherheit.

This high capacity, rolled twist drill bit made of high performance high speed steel offers increase resistance to fracture due to the rolled production process which strengthens the material.

HSS-R



Sets: Seite 304 | [Page 304](#)

< 850 N/mm ²	< 1100 N/mm ²	< 1300 N/mm ²	INOX < 850 N/mm ²	INOX > 850 N/mm ²	Grauguss Cast iron	Ti	Cu	Ms	Al	
●					●		○	○		

● empfohlen | recommended ○ bedingt geeignet | partly suitable

Ø	L1	L2	HSS-R	
			Code	Stk. pcs.
1,0	34	12	38010	10
1,1	36	14	38011	10
1,2	38	16	38012	10
1,3	38	16	38013	10
1,4	40	18	38014	10
1,5	40	18	38015	10
1,6	43	20	38016	10
1,7	43	20	38017	10
1,8	46	22	38018	10
1,9	46	22	38019	10
2,0	49	24	38020	10
2,1	49	24	38021	10
2,2	53	27	38022	10
2,3	53	27	38023	10
2,4	57	30	38024	10
2,5	57	30	38025	10
2,6	57	30	38026	10
2,7	61	33	38027	10
2,8	61	33	38028	10
2,9	61	33	38029	10
3,0	61	33	38030	10
3,1	65	36	38031	10
3,2	65	36	38032	10
3,3	65	36	38033	10
3,4	70	39	38034	10
3,5	70	39	38035	10
3,6	70	39	38036	10
3,7	70	39	38037	10
3,8	75	43	38038	10

Ø	L1	L2	HSS-R	
			Code	Stk. pcs.
3,9	75	43	38039	10
4,0	75	43	38040	10
4,1	75	43	38041	10
4,2	75	43	38042	10
4,3	80	47	38043	10
4,4	80	47	38044	10
4,5	80	47	38045	10
4,6	80	47	38046	10
4,7	80	47	38047	10
4,8	86	52	38048	10
4,9	86	52	38049	10
5,0	86	52	38050	10
5,1	86	52	38051	10
5,2	86	52	38052	10
5,3	86	52	38053	10
5,4	93	57	38054	10
5,5	93	57	38055	10
5,6	93	57	38056	10
5,7	93	57	38057	10
5,8	93	57	38058	10
5,9	93	57	38059	10
6,0	93	57	38060	10
6,1	101	63	38061	10
6,2	101	63	38062	10
6,3	101	63	38063	10
6,4	101	63	38064	10
6,5	101	63	38065	10
6,6	101	63	38066	10
6,7	101	63	38067	10

Ø	L1	L2	HSS-R	
			Code	Stk. pcs.
6,8	109	69	38068	10
6,9	109	69	38069	10
7,0	109	69	38070	10
7,1	109	69	38071	10
7,2	109	69	38072	10
7,3	109	69	38073	10
7,4	109	69	38074	10
7,5	109	69	38075	10
7,6	117	75	38076	10
7,7	117	75	38077	10
7,8	117	75	38078	10
7,9	117	75	38079	10
8,0	117	75	38080	10
8,1	117	75	38081	10
8,2	117	75	38082	10
8,3	117	75	38083	10
8,4	117	75	38084	10
8,5	117	75	38085	10
8,6	125	81	38086	10
8,7	125	81	38087	10
8,8	125	81	38088	10
8,9	125	81	38089	10
9,0	125	81	38090	10

Ø	L1	L2	HSS-R	
			Code	Stk. pcs.
9,1	125	81	38091	10
9,2	125	81	38092	10
9,3	125	81	38093	10
9,4	125	81	38094	10
9,5	125	81	38095	10
9,6	133	87	38096	10
9,7	133	87	38097	10
9,8	133	87	38098	10
9,9	133	87	38099	10
10,0	133	87	38100	10
10,2	133	87	38102	10
10,5	133	87	38105	5
11,0	142	94	38110	5
11,5	142	94	38115	5
12,0	151	101	38120	5
12,5	151	101	38125	5
13,0	151	101	38130	5
13,5	160	108	38135	5
14,0	160	108	38140	5
14,5	169	114	38145	5
15,0	169	114	38150	5
15,5	178	120	38155	5
16,0	178	120	38160	5





Spiralbohrer | Twist Drills DIN 338 | Typ N | HSS-R reduzierter Schaft | reduced shank

HSS-R	DIN 338	N	5xD	118°	20-30°	Form N	
-------	---------	---	-----	------	--------	--------	--

Ideal geeignet zum Bohren größerer Bohrdurchmesser mit allen gängigen Bohrmaschinen mit einem Spannfutter bis 13,0 mm.

Ideally suitable for drilling larger drilling diameters on all commonly-used drilling machines with a clamping chuck up to 13,0 mm.

 < 850 N/mm ²	 < 1100 N/mm ²	 < 1300 N/mm ²	INOX < 850 N/mm ²	INOX > 850 N/mm ²	Grauguss Cast iron	Ti	Cu	Ms	Al	
●					●		○	○		

● empfohlen | recommended ○ bedingt geeignet | partly suitable

Ø1	L1	L2	Ø2	HSS-R	
				Code	Stk. pcs.
10,5	133,0	30,0	10	38201	1
11,0	142,0	30,0	10	38202	1
11,5	142,0	30,0	10	38203	1
12,0	151,0	30,0	10	38204	1
12,5	151,0	30,0	10	38205	1
13,0	151,0	30,0	10	38206	1
13,5	160,0	30,0	10	38207	1
14,0	160,0	30,0	10	38208	1
14,5	169,0	30,0	10	38209	1
15,0	169,0	30,0	10	38210	1
15,5	178,0	30,0	10	38211	1
16,0	178,0	30,0	10	38212	1
16,5	184,0	35,0	13	38213	1
17,0	184,0	35,0	13	38214	1
17,5	191,0	35,0	13	38215	1
18,0	191,0	35,0	13	38216	1
18,5	198,0	35,0	13	38217	1
19,0	198,0	35,0	13	38218	1
19,5	205,0	35,0	13	38219	1
20,0	205,0	35,0	13	38220	1
22,0	205,0	35,0	13	38224	1
24,0	205,0	35,0	13	38225	1
25,0	205,0	35,0	13	38226	1



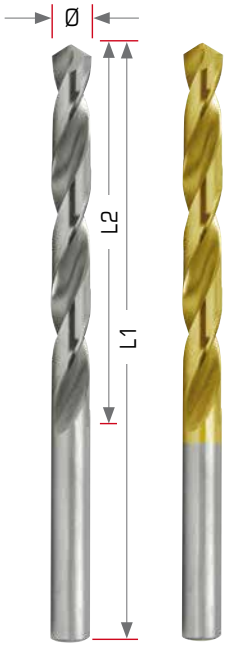

Spiralbohrer | Twist Drills DIN 338 | Typ N | HSS-G

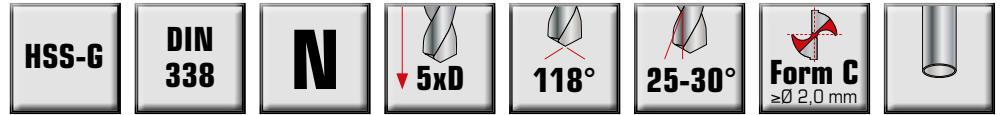

Der leistungsstarke, komplett geschliffene Spiralbohrer aus Hochleistungs-Schnellarbeitsstahl verfügt über eine erhöhte Rundlaufgenauigkeit. Die TIN-Beschichtung erhöht die Oberflächenhärte auf ca. 2300 HV und die Warmhärtebeständigkeit bis 600° C. Erzielung hoher Standzeiten bei erhöhten Schnittwerten.

This high capacity, completel ground twist drill bit made of high performance high speed steel has increased true running accuracy. The TIN coating increases the tool's surface hardness to approx. 2300 HV and its heat hardness strength up to 600°C. Achieves long service lives coupled with increased cutting values.

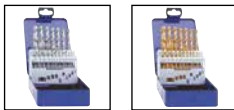

Sets: Seiten 305 - 306 | [Pages 305 - 306](#)

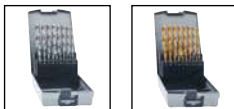

Sets in Kunststoffbox: Seite 307 | [Sets in plastic case: page 307](#)

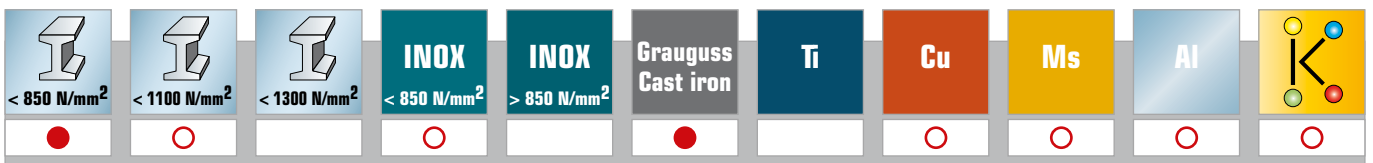

● empfohlen | recommended ○ bedingt geeignet | partly suitable

Ø	L1	L2	HSS-G		HSS-G	
			Code	Stk. pcs.	Code	Stk. pcs.
0,3	19	3	32101	10	32501	10
0,4	20	5	32102	10	32502	10
0,5	22	6	32103	10	32503	10
0,6	24	7	32104	10	32504	10
0,7	28	9	32105	10	32505	10
0,8	30	10	32106	10	32506	10
0,9	32	11	32107	10	32507	10
1,0	34	12	32108	10	32508	10
1,1	36	14	32109	10	32509	10
1,2	38	16	32110	10	32510	10
1,3	38	16	32112	10	32512	10
1,4	40	18	32113	10	32513	10
1,5	40	18	32114	10	32514	10
1,6	43	20	32115	10	32515	10

Fortsetzung | Continuation

Spiralbohrer | Twist Drills DIN 338 | Typ N | HSS-G

Ø	L1	L2	HSS-G		HSS-G	
			Code	Stk. pcs.	Code	Stk. pcs.
1,7	43	20	32116	10	32516	10
1,8	46	22	32118	10	32518	10
1,9	46	22	32119	10	32519	10
2,0	49	24	32120	10	32520	10
2,1	49	24	32121	10	32521	10
2,2	53	27	32122	10	32522	10
2,3	53	27	32124	10	32524	10
2,4	57	30	32125	10	32525	10
2,5	57	30	32126	10	32526	10
2,6	57	30	32127	10	32527	10
2,7	61	33	32128	10	32528	10
2,8	61	33	32130	10	32530	10
2,9	61	33	32131	10	32531	10
3,0	61	33	32132	10	32532	10
3,1	65	36	32133	10	32533	10
3,2	65	36	32134	10	32534	10
3,3	65	36	32136	10	32536	10
3,4	70	39	32137	10	32537	10
3,5	70	39	32138	10	32538	10
3,6	70	39	32139	10	32539	10
3,7	70	39	32140	10	32540	10
3,8	75	43	32142	10	32542	10
3,9	75	43	32143	10	32543	10
4,0	75	43	32144	10	32544	10
4,1	75	43	32145	10	32545	10
4,2	75	43	32146	10	32546	10
4,3	80	47	32148	10	32548	10
4,4	80	47	32149	10	32549	10
4,5	80	47	32150	10	32550	10
4,6	80	47	32151	10	32551	10
4,7	80	47	32152	10	32552	10
4,8	86	52	32154	10	32554	10
4,9	86	52	32155	10	32555	10
5,0	86	52	32156	10	32556	10
5,1	86	52	32157	10	32557	10
5,2	86	52	32158	10	32558	10
5,3	86	52	32160	10	32560	10
5,4	93	57	32161	10	32561	10
5,5	93	57	32162	10	32562	10
5,6	93	57	32163	10	32563	10
5,7	93	57	32164	10	32564	10
5,8	93	57	32166	10	32566	10
5,9	93	57	32167	10	32567	10
6,0	93	57	32168	10	32568	10
6,1	101	63	32169	10	32569	10
6,2	101	63	32170	10	32570	10
6,3	101	63	32172	10	32572	10
6,4	101	63	32173	10	32573	10
6,5	101	63	32174	10	32574	10
6,6	101	63	32175	10	32575	10
6,7	101	63	32176	10	32576	10
6,8	109	69	32178	10	32578	10
6,9	109	69	32179	10	32579	10
7,0	109	69	32180	10	32580	10
7,1	109	69	32181	10	32581	10
7,2	109	69	32182	10	32582	10
7,3	109	69	32184	10	32584	10
7,4	109	69	32185	10	32585	10
7,5	109	69	32186	10	32586	10
7,6	117	75	32187	10	32587	10

Fortsetzung | Continuation

Spiralbohrer | Twist Drills
DIN 338 | Typ N | HSS-G

Ø	L1	L2	HSS-G		HSS-G	
			Code	Stk. pcs.	Code	Stk. pcs.
7,7	117	75	32188	10	32588	10
7,8	117	75	32190	10	32590	10
7,9	117	75	32191	10	32591	10
8,0	117	75	32192	10	32592	10
8,1	117	75	32193	10	32593	10
8,2	117	75	32194	10	32594	10
8,3	117	75	32196	10	32596	10
8,4	117	75	32197	10	32597	10
8,5	117	75	32198	10	32598	10
8,6	125	81	32199	10	32599	10
8,7	125	81	32200	10	32600	10
8,8	125	81	32202	10	32602	10
8,9	125	81	32203	10	32603	10
9,0	125	81	32204	10	32604	10
9,1	125	81	32205	10	32605	10
9,2	125	81	32206	10	32606	10
9,3	125	81	32208	10	32608	10
9,4	125	81	32209	10	32609	10
9,5	125	81	32210	10	32610	10
9,6	133	87	32211	10	32611	10
9,7	133	87	32212	10	32612	10
9,8	133	87	32214	10	32614	10
9,9	133	87	32215	10	32615	10
10,0	133	87	32216	10	32616	10
10,1	133	87	32217	10	32617	10
10,2	133	87	32218	10	32618	10
10,3	133	87	32219	10	32619	10
10,4	133	87	32220	10	32620	10
10,5	133	87	32221	5	32621	5
10,6	133	87	32222	5	32622	5
10,7	142	94	32223	5	32623	5
10,8	142	94	32224	5	32624	5
10,9	142	94	32225	5	32625	5
11,0	142	94	32226	5	32626	5
11,1	142	94	32227	5	32627	5
11,2	142	94	32228	5	32628	5
11,3	142	94	32229	5	32629	5
11,4	142	94	32230	5	32630	5
11,5	142	94	32231	5	32631	5
11,6	142	94	32232	5	32632	5
11,7	142	94	32233	5	32633	5
11,8	142	94	32234	5	32634	5
11,9	151	101	32235	5	32635	5
12,0	151	101	32236	5	32636	5
12,1	151	101	32237	5	32637	5
12,2	151	101	32238	5	32638	5
12,3	151	101	32239	5	32639	5
12,4	151	101	32240	5	32640	5
12,5	151	101	32241	5	32641	5
12,6	151	101	32242	5	32642	5
12,7	151	101	32243	5	32643	5
12,8	151	101	32244	5	32644	5
12,9	151	101	32245	5	32645	5
13,0	151	101	32246	5	32646	5
13,5	160	108	32247	5	32647	5
14,0	160	108	32248	5	32648	5
14,5	169	114	32249	5	32649	5
15,0	169	114	32250	5	32650	5
15,5	178	120	32251	5	32651	5
16,0	178	120	32252	5	32652	5



Spiralbohrer | Twist Drills DIN 338 | HSSE-Co 5

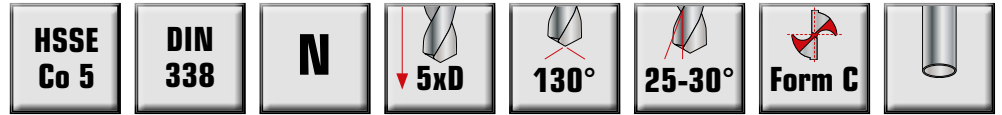

Der leistungsstarke, komplett geschliffene Spiralbohrer aus Hochleistungs-Schnellarbeitsstahl verfügt über eine erhöhte Rundlaufgenauigkeit. Der Kobalt-Anteil sorgt für eine höhere Wärme-härtebeständigkeit. Für legierte und unlegierte Stähle (bis 900 N/mm² Festigkeit), Warm- und Kaltarbeitsstähle, Vergütungs- und Einsatzstähle sowie für rost- und säurebeständige Stähle.

This high capacity, completel ground twist drill bit made of high performance high speed steel has increased true running accuracy. The cobalt content provides higher heat hardness strength. For alloyed and non-alloyed steel (up to 900 N/mm² strength), hot and cold work steel, heat-treated and case-hardened steel and for stainless and acid-resistant steel.

**HSSE
Co 5**



Sets: Seite 306 | [Page 306](#)



Sets in Kunststoffbox: Seite 307 | [Sets in plastic case: page 307](#)

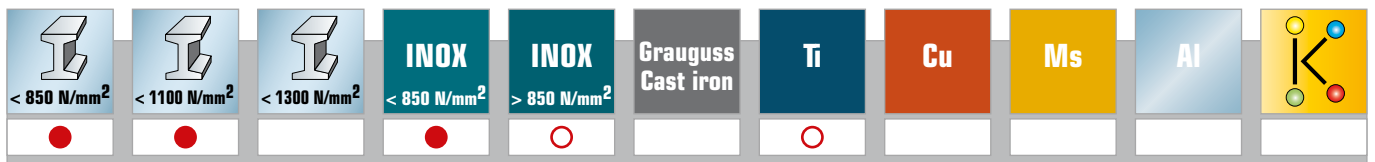

● empfohlen | recommended ○ bedingt geeignet | partly suitable

Ø	L1	L2	HSSE-Co 5	
			Code	Stk. pcs.
1,0	34	12	32308	10
1,1	36	14	32309	10
1,2	38	16	32310	10
1,3	38	16	32312	10
1,4	40	18	32313	10
1,5	40	18	32314	10
1,6	43	20	32315	10
1,7	43	20	32316	10
1,8	46	22	32318	10
1,9	46	22	32319	10
2,0	49	24	32320	10
2,1	49	24	32321	10
2,2	53	27	32322	10
2,3	53	27	32324	10
2,4	57	30	32325	10
2,5	57	30	32326	10
2,6	57	30	32327	10
2,7	61	33	32328	10
2,8	61	33	32330	10

Ø	L1	L2	HSSE-Co 5	
			Code	Stk. pcs.
2,9	61	33	32331	10
3,0	61	33	32332	10
3,1	65	36	32333	10
3,2	65	36	32334	10
3,3	65	36	32336	10
3,4	70	39	32337	10
3,5	70	39	32338	10
3,6	70	39	32339	10
3,7	70	39	32340	10
3,8	75	43	32342	10
3,9	75	43	32343	10
4,0	75	43	32344	10
4,1	75	43	32345	10
4,2	75	43	32346	10
4,3	80	47	32348	10
4,4	80	47	32349	10
4,5	80	47	32350	10
4,6	80	47	32351	10
4,7	80	47	32352	10

Ø	L1	L2	HSSE-Co 5	
			Code	Stk. pcs.
4,8	86	52	32354	10
4,9	86	52	32355	10
5,0	86	52	32356	10
5,1	86	52	32357	10
5,2	86	52	32358	10
5,3	86	52	32360	10
5,4	93	57	32361	10
5,5	93	57	32362	10
5,6	93	57	32363	10
5,7	93	57	32364	10
5,8	93	57	32366	10
5,9	93	57	32367	10
6,0	93	57	32368	10
6,1	101	63	32369	10
6,2	101	63	32370	10
6,3	101	63	32372	10
6,4	101	63	32373	10
6,5	101	63	32374	10
6,6	101	63	32375	10
6,7	101	63	32376	10
6,8	109	69	32378	10
6,9	109	69	32379	10
7,0	109	69	32380	10
7,1	109	69	32381	10
7,2	109	69	32382	10
7,3	109	69	32384	10
7,4	109	69	32385	10
7,5	109	69	32386	10
7,6	117	75	32387	10
7,7	117	75	32388	10
7,8	117	75	32390	10
7,9	117	75	32391	10
8,0	117	75	32392	10

Ø	L1	L2	HSSE-Co 5	
			Code	Stk. pcs.
8,1	117	75	32393	10
8,2	117	75	32394	10
8,3	117	75	32396	10
8,4	117	75	32397	10
8,5	117	75	32398	10
8,6	125	125	32399	10
8,7	125	125	32400	10
8,8	125	125	32402	10
8,9	125	125	32403	10
9,0	125	125	32404	10
9,1	125	125	32405	10
9,2	125	125	32406	10
9,3	125	125	32408	10
9,4	125	125	32409	10
9,5	125	125	32410	10
9,6	133	87	32411	10
9,7	133	87	32412	10
9,8	133	87	32414	10
9,9	133	87	32415	10
10,0	133	87	32416	10
10,2	133	87	32418	10
10,5	133	87	32421	5
11,0	142	94	32426	5
11,5	142	94	32431	5
12,0	151	101	32436	5
12,5	151	101	32441	5
13,0	151	101	32446	5
13,5	160	108	32447	5
14,0	160	108	32448	5
14,5	169	114	32449	5
15,0	169	114	32450	5
15,5	178	120	32451	5
16,0	178	120	32452	5





Spiralbohrer | Twist Drills DIN 340 | Typ N | HSS-R

HSS-R	DIN 340	N	10xD	118°	25-30°	Form N	
-------	---------	---	------	------	--------	--------	--

Dieser leistungsstarke, rollgewalzte Spiralbohrer aus Hochleistungs-Schnellarbeitsstahl bietet durch das rollgewalzte Herstellungsverfahren, bei dem der Werkstoff verfestigt wird, eine erhöhte Bruchsicherheit.

This high capacity, rolled twist drill bit made of high performance high speed steel offers increase resistance to fracture due to the rolled production process which strengthens the material.

HSS-R

< 850 N/mm ²	< 1100 N/mm ²	< 1300 N/mm ²	INOX < 850 N/mm ²	INOX > 850 N/mm ²	Grauguss Cast iron	Ti	Cu	Ms	Al	
●					●		○	○		

● empfohlen | recommended ○ bedingt geeignet | partly suitable

Ø	L1	L2	HSS-R	
			Code	Stk. pcs.
1,0	56,0	33,0	44010	10
1,5	70,0	45,0	44015	10
2,0	85,0	56,0	44020	10
2,5	95,0	62,0	44025	10
3,0	100,0	66,0	44030	10
3,1	106,0	69,0	44031	10
3,2	106,0	69,0	44032	10
3,3	106,0	69,0	44033	10
3,5	112,0	73,0	44035	10
4,0	119,0	78,0	44040	10
4,1	119,0	78,0	44041	10
4,2	119,0	78,0	44042	10
4,5	126,0	82,0	44045	10
5,0	132,0	87,0	44050	10
5,1	132,0	87,0	44051	10
5,2	132,0	87,0	44052	10
5,5	139,0	91,0	44055	10
5,8	139,0	91,0	44058	10
6,0	139,0	91,0	44060	10
6,5	148,0	97,0	44065	10
6,8	156,0	102,0	44068	10
7,0	156,0	102,0	44070	10
7,5	156,0	102,0	44075	10
8,0	165,0	109,0	44080	10
8,5	165,0	109,0	44085	10
9,0	175,0	115,0	44090	10
9,5	175,0	115,0	44095	10

Ø	L1	L2	HSS-R	
			Code	Stk. pcs.
10,0	184,0	121,0	44100	10
10,2	184,0	121,0	44102	10
10,5	184,0	121,0	44105	5
11,0	195,0	128,0	44110	5
11,5	195,0	128,0	44115	5
12,0	205,0	134,0	44120	5
12,5	205,0	134,0	44125	5
13,0	205,0	134,0	44130	5





Spiralbohrer | Twist Drills DIN 345 | Typ N | HSS-R



Leistungstarker, rollgewalzter Spiralbohrer mit Morsekegel. Hohe Bruchsicherheit.

Highly efficient, rolled twist drill with morse taper. Highly secure against fracture.

HSS-R

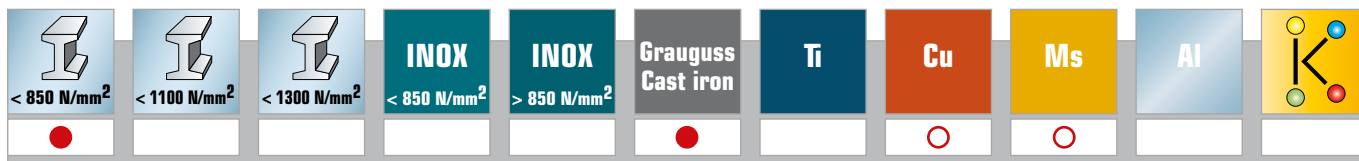

● empfohlen | recommended ○ bedingt geeignet | partly suitable

Ø	L1	L2		HSS-R	
				Code	Stk. pcs.
10,0	168,0	87,0	1	45100	1
10,5	168,0	87,0	1	45105	1
11,0	175,0	94,0	1	45110	1
11,5	175,0	94,0	1	45115	1
12,0	182,0	101,0	1	45120	1
12,5	182,0	101,0	1	45125	1
13,0	182,0	101,0	1	45130	1
13,5	189,0	108,0	1	45135	1
14,0	189,0	108,0	1	45140	1
14,5	212,0	114,0	2	45145	1
15,0	212,0	114,0	2	45150	1
15,5	218,0	120,0	2	45155	1
16,0	218,0	120,0	2	45160	1
16,5	223,0	125,0	2	45165	1
17,0	223,0	125,0	2	45170	1
17,5	228,0	130,0	2	45175	1
18,0	228,0	130,0	2	45180	1
18,5	233,0	135,0	2	45185	1
19,0	233,0	135,0	2	45190	1
19,5	238,0	140,0	2	45195	1
20,0	238,0	140,0	2	45200	1
20,5	243,0	145,0	2	45205	1
21,0	243,0	145,0	2	45210	1
21,5	248,0	150,0	2	45215	1
22,0	248,0	150,0	2	45220	1
22,5	253,0	155,0	2	45225	1
23,0	253,0	155,0	2	45230	1

Ø	L1	L2		HSS-R	
				Code	Stk. pcs.
23,5	276,0	155,0	3	45235	1
24,0	281,0	160,0	3	45240	1
24,5	281,0	160,0	3	45245	1
25,0	281,0	160,0	3	45250	1
25,5	286,0	165,0	3	45255	1
26,0	286,0	165,0	3	45260	1
26,5	286,0	165,0	3	45265	1
27,0	291,0	170,0	3	45270	1
27,5	291,0	170,0	3	45275	1
28,0	291,0	170,0	3	45280	1
28,5	296,0	175,0	3	45285	1
29,0	296,0	175,0	3	45290	1
29,5	296,0	175,0	3	45295	1
30,0	296,0	175,0	3	45300	1
30,5	301,0	180,0	3	45305	1
31,0	301,0	180,0	3	45310	1
31,5	301,0	180,0	3	45315	1
32,0	334,0	185,0	4	45320	1
32,5	334,0	185,0	4	45325	1
33,0	334,0	185,0	4	45330	1
33,5	334,0	185,0	4	45335	1
34,0	339,0	190,0	4	45340	1
34,5	339,0	190,0	4	45345	1
35,0	339,0	190,0	4	45350	1
35,5	339,0	190,0	4	45355	1
36,0	344,0	195,0	4	45360	1
36,5	344,0	195,0	4	45365	1

Fortsetzung | Continuation

Spiralbohrer | Twist Drills DIN 345 | Typ N | HSS-R

Ø	L1	L2		HSS-R	
				Code	Stk. pcs.
37,0	344,0	195,0	4	45370	1
37,5	344,0	195,0	4	45375	1
38,0	349,0	200,0	4	45380	1
38,5	349,0	200,0	4	45385	1
39,0	349,0	200,0	4	45390	1
39,5	349,0	200,0	4	45395	1
40,0	349,0	200,0	4	45400	1
41,0	354,0	205,0	4	45410	1
42,0	354,0	205,0	4	45420	1
43,0	359,0	210,0	4	45430	1
44,0	359,0	210,0	4	45440	1
45,0	359,0	210,0	4	45450	1
46,0	364,0	215,0	4	45460	1
47,0	364,0	215,0	4	45470	1
48,0	369,0	220,0	4	45480	1
49,0	369,0	220,0	4	45490	1
50,0	369,0	220,0	4	45500	1



Für Ihre Notizen | For your notes

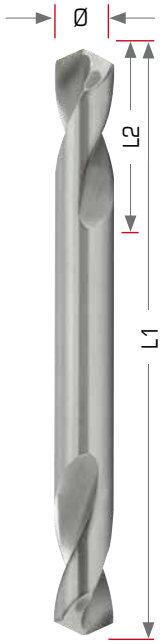

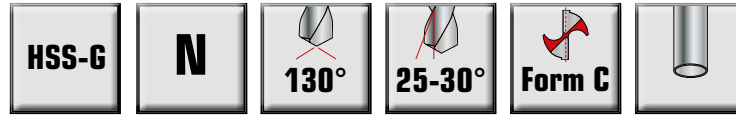

HSS-G

Doppelendbohrer Double end drills Typ KV | HSS-G

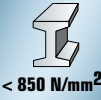
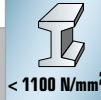
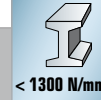

Extra kurzer und stabiler Standardbohrer. Noch kürzer als DIN 1897. Hohe Bruchsicherheit. Ideal geeignet für Montagearbeiten in dünnwandigen Materialien wie z.B. Blechen, Flach- und Profileisen. Einsatz in Handbohrmaschinen, doppelseitig verwendbar. Hauptsächlich für Nietungen und Karosseriearbeiten. Vorteile DIN 1412 C: gute Zentrierung, geringe Vorschubkraft, durch Spanverteilung verbesserter Spantransport.

Extra short and stable standard drill. Shorter than DIN 1897. Ideally suitable for assembly work in thin-walled materials such as sheet steels, flat steels and profile steels. High security against fracture. For use in hand-held drilling machines. Usable at both ends. Advantages DIN 1412 C: good centring, little pressure required. Chip distribution improves chip removal.

 < 850 N/mm ²	 < 1100 N/mm ²	 < 1300 N/mm ²	INOX < 850 N/mm ²	INOX > 850 N/mm ²	Grauguss Cast iron	Ti	Cu	Ms	Al	
●	○		○		○		○	○	○	○

● empfohlen | recommended ○ bedingt geeignet | partly suitable

Ø	L1	L2	HSS-G	
			Code	Stk. pcs.
2,5	43,0	10,0	36601	10
2,8	46,0	11,0	36602	10
3,0	46,0	11,0	36603	10
3,1	49,0	11,0	36604	10
3,2	49,0	11,0	36605	10
3,3	49,0	11,0	36606	10
3,4	52,0	14,0	36607	10
3,5	52,0	14,0	36608	10
4,0	55,0	14,0	36609	10
4,1	55,0	14,0	36610	10
4,2	55,0	14,0	36611	10
4,3	58,0	17,0	36612	10
4,5	58,0	17,0	36613	10
4,8	62,0	17,0	36614	10
4,9	62,0	17,0	36615	10
5,0	62,0	17,0	36616	10
5,1	62,0	17,0	36617	10
5,2	62,0	17,0	36618	10
5,5	66,0	20,0	36619	10
6,0	66,0	20,0	36620	10
6,5	70,0	20,0	36621	10

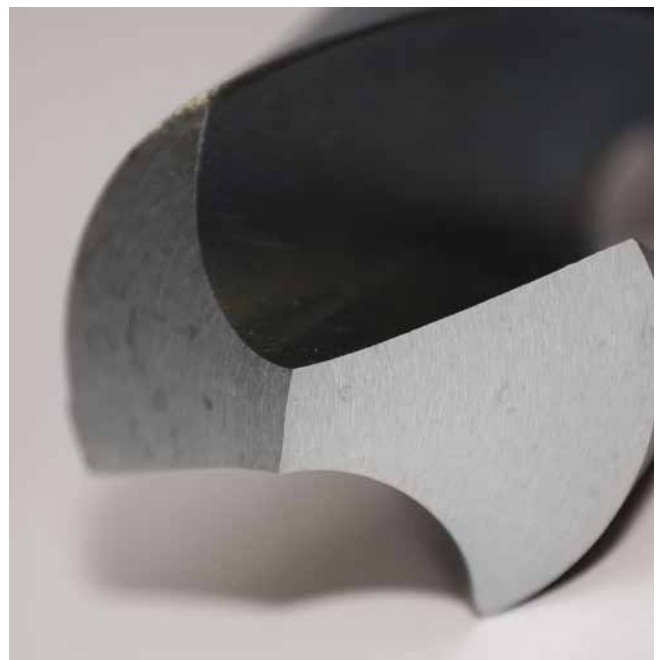

Spiralbohrer Sets | Sets of Twist Drills DIN 338 | Typ N | HSS-R

Spiralbohrer Set • Sets of Twist Drills



Technische Information Spiralbohrer HSS-R

Rollgewalzte Spiralbohrer aus Hochleistungs-Schnellarbeitsstahl bieten durch rollgewalztes Herstellungsverfahren eine erhöhte Bruchstabilität.

INHALT	HSS-R	
	Code	Stk. pcs.
19 tlg. pcs. DIN 338 Typ N Ø 1,0 mm – 10,0 mm x 0,5 mm steigend in steps	32001	1
24 tlg. pcs. DIN 338 Typ N Ø 1,0 mm – 10,5 mm x 0,5 mm steigend in steps	32300	1
25 tlg. pcs. DIN 338 Typ N Ø 1,0 mm – 13,0 mm x 0,5 mm steigend in steps	32002	1



Technical Information Twist Drills HSS-R

This high capacity, rolled twist drill bit made of high performance high speed steel offers increase resistance to fracture due to the rolled production process which strengthens the material.

INHALT	HSS-R	
	Code	Stk. pcs.
50 tlg. pcs. DIN 338 Typ N Ø 1,0 mm – 5,9 mm x 0,1 mm steigend in steps	32303	1
41 tlg. pcs. DIN 338 Typ N Ø 6,0 mm – 10,0 mm x 0,1 mm steigend in steps	32301	1



INHALT	HSS-R	
	Code	Stk. pcs.
170 tlg. pcs. DIN 338 Typ N Ø 1,0 mm – 10,0 mm x 0,5 mm steigend in steps	32304	1

Spiralbohrer Sets | Sets of Twist Drills DIN 338 | Typ N | HSS-G



Technische Information Spiralbohrer HSS-G

Spitzenanschliff: Kegelmantelschliff • Spiralwinkel: 20 - 30°
Ø-Toleranz: h8 • rechtsschneidend

INHALT	HSS-G	
	Code	Stk. pcs.
19 tlg. pcs. DIN 338 Typ N Ø 1,0 mm – 10,0 mm x 0,5 mm steigend in steps	32003	1
24 tlg. pcs. DIN 338 Typ N Ø 1,0 mm – 10,5 mm x 0,5 mm steigend in steps	32290	1
25 tlg. pcs. DIN 338 Typ N Ø 1,0 mm – 13,0 mm x 0,5 mm steigend in steps	32004	1



Technical Information Twist Drills HSS-G

Tip grinding: Cone envelope grinding • Spiral angle: 20 - 30°
Diameter tolerance: h8 • clockwise-cutting

INHALT	HSS-G	
	Code	Stk. pcs.
50 tlg. pcs. DIN 338 Typ N Ø 1,0 mm – 5,9 mm x 0,1 mm steigend in steps	32288	1
41 tlg. pcs. DIN 338 Typ N Ø 6,0 mm – 10,0 mm x 0,1 mm steigend in steps	32289	1



Spiralbohrer Sets | Sets of Twist Drills DIN 338 | Typ N | HSS-G



Technische Information TIN-Beschichtung

Die Titan-Nitrid-Beschichtung erhöht die Werkzeugstandzeiten und ermöglicht höhere Schnittgeschwindigkeiten.

Technical Information TIN Coating

The titanium nitride coating increases the tool life and allows higher cutting speeds.

INHALT	HSS-G	
	Code	Stk. pcs.
19 tlg. pcs. DIN 338 Typ N Ø 1,0 mm – 10,0 mm x 0,5 mm steigend in steps	32007	1
25 tlg. pcs. DIN 338 Typ N Ø 1,0 mm – 13,0 mm x 0,5 mm steigend in steps	32008	1

Spiralbohrer Sets | Sets of Twist Drills DIN 338 | Typ N | HSSE-Co 5



Technische Information

Der Kobaltanteil sorgt für eine höhere Wärmehärtebeständigkeit – Ideal zum Bohren von rost-, säure- und hitzebeständigem Stahl mit hoher Festigkeit.

Technical Information

High-performance drill with distinctive heat resistance. Ideal for drilling high-strength stainless, acid-resistant and heat-resistant steel.

INHALT	HSSE-Co 5	
	Code	Stk. pcs.
19 tlg. pcs. DIN 338 Typ N Ø 1,0 mm – 10,0 mm x 0,5 mm steigend in steps	32005	1
25 tlg. pcs. DIN 338 Typ N Ø 1,0 mm – 13,0 mm x 0,5 mm steigend in steps	32006	1

Spiralbohrer Sets | Sets of Twist Drills

DIN 338 | Typ N | HSS-G | HSSE-Co 5

Kunststoffbox | Plastic case



Technische Information Spiralbohrer HSS-G

Spitzenanschliff: Kegelmantelschliff • Spiralwinkel: 20 - 30°
Ø-Toleranz: h8 • rechtsschneidend

Technical Information Twist Drills HSS-G

Tip grinding: Cone envelope grinding • Spiral angle: 20 - 30°
Diameter tolerance: h8 • clockwise-cutting

INHALT	HSS-G	
	Code	Stk. pcs.
19 tlg. pcs. DIN 338 Typ N Ø 1,0 mm – 10,0 mm x 0,5 mm steigend in steps	32291	1
25 tlg. pcs. DIN 338 Typ N Ø 1,0 mm – 13,0 mm x 0,5 mm steigend in steps	32292	1



Technische Information TIN-Beschichtung

Die Titan-Nitrid-Beschichtung erhöht die Werkzeugstandzeiten und ermöglicht höhere Schnittgeschwindigkeiten.

Technical Information TIN Coating

The titanium nitride coating increases the tool life and allows higher cutting speeds.

INHALT	HSS-G	
	Code	Stk. pcs.
19 tlg. pcs. DIN 338 Typ N Ø 1,0 mm – 10,0 mm x 0,5 mm steigend in steps	32691	1
25 tlg. pcs. DIN 338 Typ N Ø 1,0 mm – 13,0 mm x 0,5 mm steigend in steps	32692	1



Technische Information

Der Kobaltanteil sorgt für eine höhere Wärmehärtebeständigkeit – Ideal zum Bohren von rost-, säure- und hitzebeständigem Stahl mit hoher Festigkeit.

Technical Information

High-performance drill with distinctive heat resistance. Ideal for drilling high-strength stainless, acid-resistant and heat-resistant steel.

INHALT	HSSE-Co 5	
	Code	Stk. pcs.
19 tlg. pcs. DIN 338 Typ N Ø 1,0 mm – 10,0 mm x 0,5 mm steigend in steps	32491	1
25 tlg. pcs. DIN 338 Typ N Ø 1,0 mm – 13,0 mm x 0,5 mm steigend in steps	32492	1



GEWINDEREPARATUR

THREAD REPAIRING

PROFICOIL
Professional Thread Repairing System

Gewindereparatur - Beschreibung / Anwendung

Thread repairing - Description / Application

310-311

Gewindereparatursortiment

Thread Repairing Assortment

■ metrisch | metric | metrisch fein | metric fine

312-314

Gewindereparatursets / Gewindereparaturkit Zündkerze

Thread Repairing Sets /

Thread Repairing Kit Spark plug

■ metrisch | metric | metrisch fein | metric fine

314-316

Gewindeeinsätze

Thread Inserts

■ metrisch | metric | metrisch fein | metric fine

318

Gewindebohrer / Spezialgewindebohrer für Zündkerzen

Taps / Tap Spark plug

■ metrisch | metric | metrisch fein | metric fine

319-320

Einbauwerkzeug

Fitting Tool

321

Zapfenbrecher

Pin-Breaker

322

Spiralbohrer

Twist Drills

323-324

Beschreibung | Description

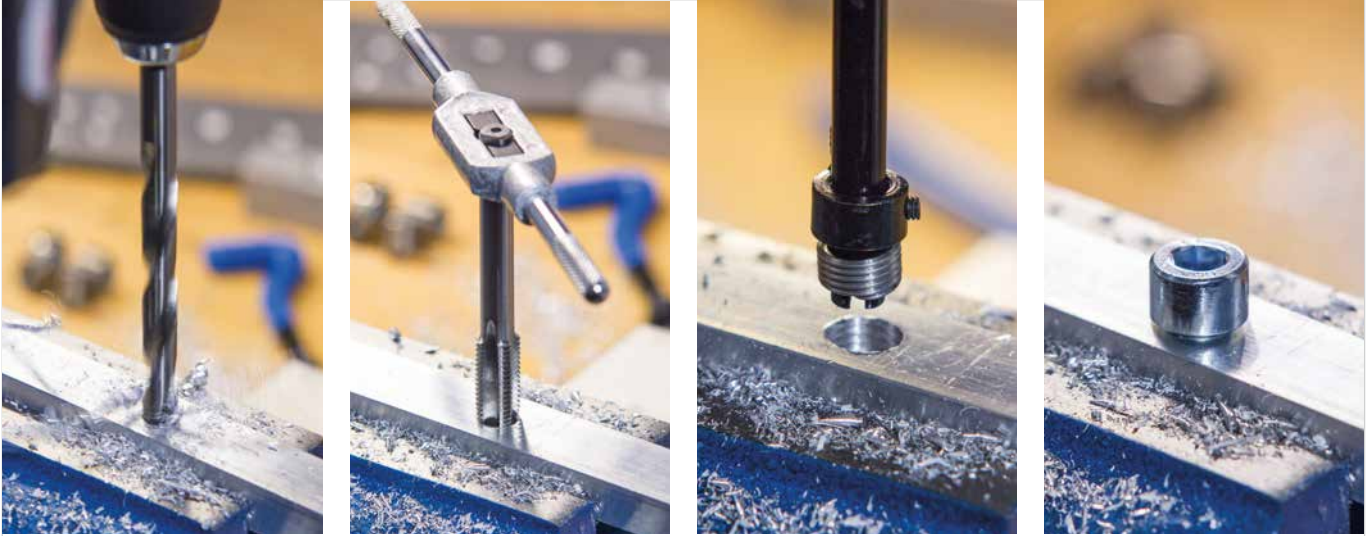

Verschleiß, Korrosion oder ein zu großes Schraubenzugsmoment sind einige der Gründe, die zur Zerstörung von Gewinden führen können. Das PROFICOIL Gewindereparatur-Programm ermöglicht die schnelle und kostengünstige Reparatur beschädigter und abgenutzter Gewinde. Zusätzlich werden Ausschussteile zurückgewonnen, indem ein Gewindeeinsatz in das Bauteil eingesetzt wird und somit Kosten, die durch einen Austausch entstehen, eingespart. Hochwertig veredelter Stahl sorgt für gute Innengewinde, die Temperatur- und Korrosionseinwirkungen widerstehen. Weiterer Einsatzzweck ist die Gewindeverstärkung. Diese wird bei Werkstoffen mit geringer Scherfestigkeit (z.B. Aluminium, Kunststoffe,...) eingesetzt und verstärkt das Muttergewinde. Die Verstärkung ermöglicht eine kleiner dimensionierte Schraubenverbindung und spart so Raum, Gewicht und Kosten.

Wear, corrosion or excessive screw tightening torque are just some of the reasons which lead to threads getting damaged beyond repair. The Proficoil thread repair range enables worn and damaged threads to be repaired quickly and at low cost. In addition rejected components can be reclaimed by installing a thread insert. Costs of acquisition and processing can be saved. In high-quality, high-grade steel for a good female thread which is resistant to the influence of temperature and corrosion. Furthermore threads are reinforced whenever low-strength materials (e.g. aluminium, plastics,...) are used. The reinforcement enables smaller bolted connections. This saves space, weight and costs.

Anwendung | Application



1

Bohren

Beschädigtes Gewinde wird mit einem Spiralbohrer aufgebohrt. Bohrung mit einem 90° Kegelsenker ansenken und somit entgraten.

Drilling

Drill open the damaged threads with a twist drill. Use a 90° countersink to deburr the drill hole.



2

Gewinde

Mit dem Gewindebohrer das Aufnahmegewinde in das aufgebohrte Loch schneiden. Einsatz von Schneidöl ist empfehlenswert.

Tapping

Cut the tap hole in the bored out hole using the screw tap. Cutting oil recommended.



3

Einbau des Gewindeeinsatzes

Den passenden Gewindeeinsatz mit dem Mitnehmerzapfen in die Nut des Eindrehwerkzeuges setzen und den Stelling fixieren.

Installing thread insert

Place thread insert on Fitting-Tool. Center the insert tang in the slot.

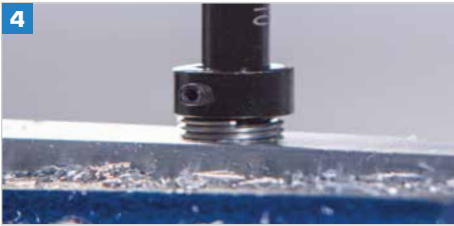

4

Eindreuen des Gewindeeinsatzes

Den Einsatz in Gewinderichtung eindrehen.

Screw in thread insert

Screw thread inserts in the direction of thread using the Fitting-tool.



5

Zapfenbrecher

Das Eindrehwerkzeug herausnehmen und den Mitnehmerzapfen mit dem Zapfenbrecher entfernen.

Pin-Breaker

Take out the screwing in die and remove the drive stub with the Pin-breaker.



6

Neues Gewinde

Das neue Gewinde hat die exakte Größe des Ausgangsgewindes.

New thread

The new thread has the exact size of the original thread.



7

Belastbarkeit

Das reparierte bzw. erneuerte Gewinde ist durch den Federgewindeeinsatz belastbarer, als das ursprüngliche Gewinde.

Load capacity

The repaired thread is stronger than the original one.

Vorteile | Advantages

- einfache und schnelle Montage
- hochbelastbar und verschleißfrei
- korrosions- und temperaturbeständig

Einsatzbeispiele:

- Gewindepanzerung von Werkstoffen mit geringer Scherfestigkeit (z.B. Aluminium- und Magnesiumlegierungen)
- Maschinenbau
- KFZ- und Elektrotechnik

- Fast and easy to install
- Stress resistant and wear-free
- Corrosion-resistant and thermostable

Examples of applications:

- Thread reinforcement for materials with low shearing strength (e.g. aluminium alloys and magnesium alloys)
- Mechanical engineering
- Automotive and electrical engineering

Premium Gewindereparatursortiment Thread Repairing Assortment | M3 - M12

Sortiment • Assortment



HSS





Inhalt

- 7 Spiralbohrer
- 7 Gewindebohrer
- 7 Einbauwerkzeug
- 7 Zapfenbrecher
- Gewindeeinsätze

Contents

- 7 Twist Drill
- 7 Tap
- 7 Fitting Tool
- 7 Pin-Breaker
- Thread Inserts



M	Ø mm	mm			1,0xD	1,5xD	2,5xD	HSS		
					Stk. pcs.	Stk. pcs.	Stk. pcs.	Code	Stk. pcs.	
M 3 x 0,50	3,2	M 3 x 0,50	No.04	No.04	5	5	5			
M 4 x 0,70	4,2	M 4 x 0,70	No.06	No.06	5	5	5			
M 5 x 0,80	5,2	M 5 x 0,80	No.08	No.08	5	5	5			
M 6 x 1,00	6,3	M 6 x 1,00	No.09	No.09	5	5	5			
M 8 x 1,25	8,3	M 8 x 1,25	No.11	No.11	5	5	5			
M 10 x 1,50	10,4	M 10 x 1,50	No.13	No.13	5	5	5			
M 12 x 1,75	12,4	M 12 x 1,75	No.15	No.15	5	5	5			
M3 - M12	133-teilig 133 pieces							40341	1	

Vorteile | Advantages



Optimiertes Werkzeugkonzept
Optimised tool configuration



Innovatives Produktdesign
Innovative product design

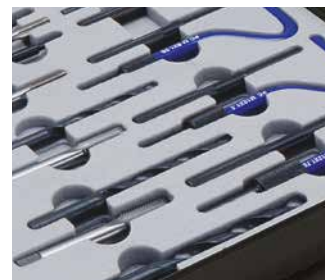

Schaumstoffinlays herausnehmbar
Removable inlays



Koffer rutschsicher und stapelbar
Non-slip and stackable toolboxes



Gewindereparatur- sortiment M5 - M12 Thread Repairing Assortment



Inhalt
5 Spiralbohrer
5 Gewindebohrer
5 Einbauwerkzeug
5 Zapfenbrecher
Gewindeeinsätze 1,5xD

Contents
5 Twist Drill
5 Tap
5 Fitting Tool
5 Pin-Breaker
Thread Inserts 1,5xD

M	Ø mm	mm			1,5xD Stk. pcs.	HSS	
						Code	Stk. pcs.
M 5 x 0,80	5,2	M 5 x 0,80	No.08	No.08	25	40335	1
M 6 x 1,00	6,3	M 6 x 1,00	No.09	No.09	25		
M 8 x 1,25	8,3	M 8 x 1,25	No.11	No.11	25		
M 10 x 1,50	10,4	M 10 x 1,50	No.13	No.13	25		
M 12 x 1,75	12,4	M 12 x 1,75	No.15	No.15	10		
M5 - M12			130-teilig 130 pieces				



Gewindereparatur- sortiment M6 - M14 Thread Repairing Assortment



Inhalt
4 Spiralbohrer
5 Gewindebohrer
5 Einbauwerkzeug
5 Zapfenbrecher
Gewindeeinsätze 1,5xD

Contents
4 Twist Drill
5 Tap
5 Fitting Tool
5 Pin-Breaker
Thread Inserts 1,5xD

M	Ø mm	mm			1,5xD Stk. pcs.	HSS	
						Code	Stk. pcs.
M 6 x 1,00	6,3	M 6 x 1,00	No.09	No.09	25	40337	1
M 8 x 1,25	8,3	M 8 x 1,25	No.11	No.11	25		
M 10 x 1,50	10,4	M 10 x 1,50	No.13	No.13	25		
M 12 x 1,75	12,4	M 12 x 1,75	No.15	No.15	10		
Mf 14 x 1,25	-	Mf 14 x 1,25	No.16	No.16	10		
M6 - Mf14			114-teilig 114 pieces				



Gewindereparatur- sortiment M6 - M14 Thread Repairing Assortment



Inhalt

4 Spiralbohrer
4 Gewindebohrer
1 Spezial-Gewindebohrer
5 Einbauwerkzeug
4 Zapfenbrecher
Gewindeeinsätze 1,5xD

Contents

4 Twist Drill
4 Tap
1 Special-Tap
5 Fitting Tool
4 Pin-Breaker
Thread Inserts 1,5xD

M	Mf	Ø mm	mm	No.	No.	1,5xD Stk. pcs.	HSS			
							Code	Stk. pcs.		
M 6 x 1,00		6,3	M 6 x 1,00	No.09	No.09	25				
M 8 x 1,25		8,3	M 8 x 1,25	No.11	No.11	25				
M 10 x 1,50		10,4	M 10 x 1,50	No.13	No.13	25				
M 12 x 1,75		12,4	M 12 x 1,75	No.15	No.15	10				
Mf 14 x 1,25		-	Mf 14 x 1,25	No.16		10				
M6 - M14							113-teilig 113 pieces		40338	1



Zündkerze | Spark plug

Beschreibung | Description

Zündkerzengewinde sind aufgrund langer Laufzeiten von Fahrzeugen hohen Belastungen ausgesetzt. Dadurch führen Verschleiß und Korrosion immer wieder zur Zerstörung der Gewinde. Das PROFICOIL Gewindereparatur-Programm ermöglicht die schnelle und kostengünstige Reparatur beschädigter und abgenutzter Gewinde. Hochwertig veredelter Stahl sorgt für gute Innengewinde, die Temperatur- und Korrosionseinwirkungen widerstehen.

Spark plug threads are subjected to a high stress in cars at run time. Therefore wear and corrosion lead to threads getting damaged beyond repair. The Proficoil thread repair range enables worn and damaged threads to be repaired quickly and at low cost. In high-quality, high-grade steel for a good female thread which is resistant to the influence of temperature and corrosion.



Gewindereparaturkit Zündkerze Thread Repairing Kit Spark plug



Inhalt

1 Spezial-Gewindebohrer
1 Einbauwerkzeug
15 Gewindeeinsätze
(5 x 8,4mm; 5 x 12,4mm;
5 x 16,4mm)

Contents

1 Tap
1 Fitting Tool
15 Thread Inserts
(5 x 8,4mm; 5 x 12,4mm;
5 x 16,4mm)

Mf	Ø mm	No.16	8,4 mm Stk. pcs.	12,4 mm Stk. pcs.	16,4 mm Stk. pcs.	HSS		
Mf 14 x 1,25	Mf 14 x 1,25	No.16	5	5	5	Code	Stk. pcs.	
Mf14						47405	1	
17-teilig 17 pieces								

Anwendung | Application

Für die Reparatur von Zündkerzengewinden ist ein spezieller Gewindebohrer entwickelt worden. Die besondere Form der Keilprofilnase ermöglicht das alte Gewinde zu reparieren, ohne es vorher aufzubohren. Die Spitze (Nase) des Gewindebohrers nutzt das Originalgewinde als Führung. Dahinter befinden sich Schneiden (Keilform), welche das Gewinde aufbohren. Der zweite Gewindeschneidbereich des Bohrers schneidet das Aufnahme-gewinde, um anschließend die Gewindeeinsätze eindrehen zu können.

Pilot Nose taps have been developed for the repair of damaged sparking plug threads without the need for additional drilling. This type of tap uses the original thread to guide the tap. It has reamer faces behind the pilot thread which cut the hole to size prior to tapping of the wire insert thread form. They are simple and easy to use and in 1 single operation ensure that the wire insert thread is concentrically aligned to the original thread. Tap creates an oversized thread for use with thread inserts.

Vorteile | Advantages

- Spezial-Gewindebohrer für Zündkerzenreparatur
- Besondere Keilprofilnase nutzt Originalgewinde als Führung
- Defektes Gewinde muss nicht aufgebohrt werden
- Special-Tap for Spark-Plug-Repair
- Pilot Nose Tap uses original thread to guide the tap
- Repairing damaged thread without the need for additional drilling



**Spezial-Gewindebohrer
Special-Tap**

Gewindereparatursets Thread Repairing Sets



Inhalt

- 1 Spiralbohrer (von M2 - M12)
- 1 Gewindebohrer
- 1 Einbauwerkzeug
- 1 Zapfenbrecher
- Gewindeeinsätze 1,5xD

Contents

- 1 Twist Drill (from M2 - M12)
- 1 Tap
- 1 Fitting Tool
- 1 Pin-Breaker
- Thread Inserts 1,5xD



M	Mf	Ø mm	mm			1,5xD Stk. pcs.	HSS	
							Code	Stk. pcs.
M 2 x 0,40		2,1	M 2 x 0,40	No.02	No.02	20	40301	1
M 2,5 x 0,45		2,6	M 2,5 x 0,45	No.03	No.03	20	40302	1
M 3 x 0,50		3,2	M 3 x 0,50	No.04	No.04	20	40303	1
M 3,5 x 0,60		3,7	M 3,5 x 0,60	No.05	No.05	20	40339	1
M 4 x 0,70		4,2	M 4 x 0,70	No.06	No.06	20	40304	1
M 5 x 0,80		5,2	M 5 x 0,80	No.08	No.08	20	40305	1
M 6 x 1,00		6,3	M 6 x 1,00	No.09	No.09	20	40306	1
M 7 x 1,00		7,3	M 7 x 1,00	No.10	No.10	20	40307	1
Mf 8 x 1,00		8,3	Mf 8 x 1,00	No.11	No.11	20	40308	1
M 8 x 1,25		8,3	M 8 x 1,25	No.11	No.11	20	40309	1
M 9 x 1,25		9,3	M 9 x 1,25	No.12	No.12	15	40310	1
Mf 10 x 1,00		10,3	Mf 10 x 1,00	No.13	No.13	15	40311	1
Mf 10 x 1,25		10,3	Mf 10 x 1,25	No.13	No.13	15	40312	1
M 10 x 1,50		10,4	M 10 x 1,50	No.13	No.13	15	40313	1
M 11 x 1,50		11,4	M 11 x 1,50	No.14	No.14	10	40340	1
Mf 12 x 1,00		12,3	Mf 12 x 1,00	No.15	No.15	10	40314	1
Mf 12 x 1,25		12,3	Mf 12 x 1,25	No.15	No.15	10	40315	1
Mf 12 x 1,50		12,4	Mf 12 x 1,50	No.15	No.15	10	40316	1
M 12 x 1,75		12,4	M 12 x 1,75	No.15	No.15	10	40334	1
Mf 14 x 1,00		-	Mf 14 x 1,00	No.16	No.16	10	40317	1
Mf 14 x 1,25		-	Mf 14 x 1,25	No.16	No.16	10	40318	1
Mf 14 x 1,50		-	Mf 14 x 1,50	No.17	No.16	10	40319	1
M 14 x 2,00		-	M 14 x 2,00	No.17	No.16	10	40320	1
Mf 16 x 1,50		-	Mf 16 x 1,50	No.18	No.17	10	40321	1
M 16 x 2,00		-	M 16 x 2,00	No.18	No.17	10	40322	1
Mf 18 x 1,50		-	Mf 18 x 1,50	No.19	No.18	5	40323	1
Mf 18 x 2,00		-	Mf 18 x 2,00	No.19	No.18	5	40324	1
M 18 x 2,50		-	M 18 x 2,50	No.19	No.18	5	40325	1
Mf 20 x 1,50		-	Mf 20 x 1,50	No.20	No.19	5	40326	1
Mf 20 x 2,00		-	Mf 20 x 2,00	No.20	No.19	5	40327	1
M 20 x 2,50		-	M 20 x 2,50	No.20	No.19	5	40328	1
Mf 22 x 1,50		-	Mf 22 x 1,50	No.21	No.20	5	40329	1
Mf 22 x 2,00		-	Mf 22 x 2,00	No.21	No.20	5	40330	1
M 22 x 2,50		-	M 22 x 2,50	No.21	No.20	5	40331	1
Mf 24 x 1,50		-	Mf 24 x 1,50	No.22	No.21	5	40332	1
Mf 24 x 2,00		-	Mf 24 x 2,00	No.22	No.21	5	40333	1
M 24 x 3,00		-	M 24 x 3,00	No.22	No.21	5	40336	1

GEWINDEREPARATUR-SET THREAD REPAIRING-SET

Inhalt
Gewindeeinsätze

Contents
Thread Inserts



Inhalt
Spiralbohrer
Gewindebohrer
Einbauwerkzeug
Zapfenbrecher

Contents
Twist Drill
Tap
Fitting Tool
Pin-Breaker



Inhalt
Bedienungsanleitung

Contents
Manual

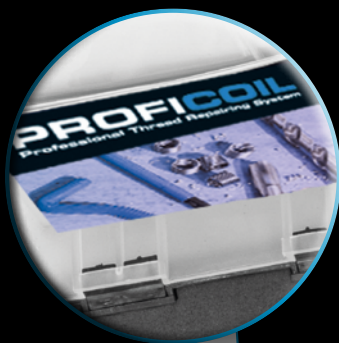

Gewindeeinsätze Thread Inserts



Gewindeeinsätze aus rostfreiem Stahl, frei durchlaufend in Standardausführung. Zur Gewindepanzerung von Werkstoffen geringer Scherfestigkeit, z.B. Aluminium- oder Magnesiumlegierungen, sowie zur Gewindereparatur abgenutzter oder beschädigter Gewinde.

Standard execution / stainless steel / Freely going through. Thread reinforcement for materials with low shearing strength, e.g. aluminium and magnesium alloys as well as to repair enables worn and damaged threads

M	Mf	VE Unit	1,0xD Code	1,5xD Code	2,0xD Code	2,5xD Code	3,0xD Code
M 2 x 0,40		50	40401	40501	46701	40601	46801
M 2,2 x 0,45		50	40436	40536	46702	40636	46802
M 2,5 x 0,45		50	40402	40502	46703	40602	46803
M 3 x 0,50		50	40403	40503	46704	40603	46804
M 3,5 x 0,60		50	40437	40537	46705	40637	46805
M 4 x 0,70		50	40404	40504	46706	40604	46806
M 5 x 0,80		50	40405	40505	46707	40605	46807
M 6 x 1,00		50	40406	40506	46708	40606	46808
M 7 x 1,00		50	40407	40507	46709	40607	46809
Mf 8 x 1,00		50	40408	40508	46710	40608	46810
M 8 x 1,25		50	40409	40509	46711	40609	46811
M 9 x 1,25		50	40410	40510	46712	40610	46812
Mf 10 x 1,00		50	40411	40511	46713	40611	46813
Mf 10 x 1,25		50	40412	40512	46714	40612	46814
M 10 x 1,50		50	40413	40513	46715	40613	46815
M 11 x 1,50		50	40438	40538	46716	40638	46816
Mf 12 x 1,00		50	40414	40514	46717	40614	46817
Mf 12 x 1,25		25	40415	40515	46718	40615	46818
Mf 12 x 1,50		25	40416	40516	46719	40616	46819
M 12 x 1,75		25	40435	40535	46720	40635	46820
Mf 14 x 1,00		25	40417	40517	46721	40617	46821
Mf 14 x 1,25		25	40418	40518	46722	40618	46822
Mf 14 x 1,50		25	40419	40519	46723	40619	46823
M 14 x 2,00		25	40420	40520	46724	40620	46824
M 16 x 2,00		25	40421	40521	46725	40621	46825
Mf 16 x 1,50		25	40422	40522	46726	40622	46826
M 18 x 2,50		25	40423	40523	46727	40623	46827
Mf 18 x 2,00		25	40424	40524	46728	40624	46828
Mf 18 x 1,50		25	40425	40525	46729	40625	46829
Mf 20 x 2,00		25	40426	40526	46730	40626	46830
Mf 20 x 1,50		25	40427	40527	46731	40627	46831
M 20 x 2,50		25	40428	40528	46732	40628	46832
Mf 22 x 1,50		10	40429	40529	46733	40629	46833
Mf 22 x 2,00		10	40430	40530	46734	40630	46834
M 22 x 2,50		10	40431	40531	46735	40631	46835
Mf 24 x 1,50		10	40432	40532	46736	40632	46836
Mf 24 x 2,00		10	40433	40533	46737	40633	46837
M 24 x 3,00		10	40434	40534	46738	40634	46838

Mf	VE Unit	8,4mm Code	12,4mm Code	16,4mm Code
Mf 14 x 1,25	50	47401	47402	47403





Gewindebohrer Taps | HSS



Einschnittgewindebohrer zum Schneiden von Innengewinden aus Hochleistungsschnell-Stahl. Das geschnittene Gewinde hat exakt das benötigte Maß, um die Gewindeeinsätze eindrehen zu können. Somit ist das Maß des zu reparierenden Gewindes wieder hergestellt.

Short machine taps for cutting internal threads made of High-speed-steel. The thread has the exact dimension to insert the coil. The dimension of the repaired thread is restored in this way.

M	Mf		Ø1	Ø2	L1	L2		HSS	
								Code	Stk. pcs.
M 2 x 0,40		2,1	2,50	2,80	9,5	44,5	2,24	40701	1
M 2,5 x 0,45		2,6	3,10	3,20	11,0	48,0	2,50	40702	1
M 3 x 0,50		3,2	3,60	4,00	13,0	53,0	3,15	40703	1
M 3,5 x 0,60		3,7	4,30	4,50	13,0	53,0	3,55	40737	1
M 4 x 0,70		4,2	4,90	5,00	16,0	58,0	4,00	40704	1
M 5 x 0,80		5,3	6,00	6,30	19,0	66,0	5,00	40705	1
M 6 x 1,00		6,3	7,30	8,00	22,0	72,0	6,30	40706	1
M 7 x 1,00		7,3	8,30	9,00	22,0	72,0	7,10	40707	1
Mf 8 x 1,00		8,3	9,30	10,00	24,0	80,0	8,00	40708	1
M 8 x 1,25		8,3	9,60	10,00	24,0	80,0	8,00	40709	1
M 9 x 1,25		9,3	10,60	8,00	25,0	85,0	6,30	40710	1
Mf 10 x 1,00		10,3	11,30	8,00	25,0	85,0	6,30	40711	1
Mf 10 x 1,25		10,3	11,60	8,00	25,0	85,0	6,30	40712	1
M 10 x 1,50		10,4	11,90	9,00	29,0	89,0	7,10	40713	1
M 11 x 1,50		11,4	12,90	9,00	29,0	89,0	7,10	40736	1
Mf 12 x 1,00		12,3	13,30	11,20	30,0	95,0	9,00	40714	1
Mf 12 x 1,25		12,3	13,60	11,20	30,0	95,0	9,00	40715	1
Mf 12 x 1,50		12,4	14,00	11,20	30,0	95,0	9,00	40716	1
M 12 x 1,75		12,4	14,30	11,20	30,0	95,0	9,00	40735	1
Mf 14 x 1,00		14,4	15,30	12,50	32,0	102,0	10,00	40717	1
Mf 14 x 1,25		14,4	15,60	12,50	32,0	102,0	10,00	40718	1
Mf 14 x 1,50		14,5	16,00	12,50	32,0	102,0	10,00	40719	1
M 14 x 2,00		14,5	16,60	12,50	32,0	102,0	10,00	40720	1
Mf 16 x 1,50		16,5	18,00	14,00	29,0	104,0	11,20	40722	1
M 16 x 2,00		16,5	18,60	14,00	37,0	112,0	11,20	40721	1
Mf 18 x 1,50		18,5	20,00	14,00	29,0	104,0	11,20	40725	1
Mf 18 x 2,00		18,5	20,60	14,00	29,0	104,0	11,20	40724	1
M 18 x 2,50		18,5	21,30	16,00	37,0	118,0	12,50	40723	1
Mf 20 x 1,50		20,5	22,00	16,00	33,0	113,0	12,50	40727	1
Mf 20 x 2,00		20,5	22,60	16,00	33,0	113,0	12,50	40726	1
M 20 x 2,50		20,5	23,30	16,00	38,0	118,0	12,50	40728	1
Mf 22 x 1,50		22,5	24,00	18,00	35,0	120,0	14,00	40729	1
Mf 22 x 2,00		22,5	24,60	18,00	35,0	120,0	14,00	40730	1
M 22 x 2,50		22,5	25,30	18,00	45,0	130,0	14,00	40731	1
Mf 24 x 1,50		24,5	26,00	18,00	35,0	120,0	14,00	40732	1
Mf 24 x 2,00		24,5	26,60	20,00	37,0	127,0	16,00	40733	1
M 24 x 3,00		24,5	27,90	20,00	48,0	138,0	16,00	40734	1



Spezial-Gewindebohrer für Zündkerzen Tap Spark plug | HSS



Spezial-Gewindebohrer für Zündkerzenreparatur. Der Gewindebohrer hat eine Keilprofilnase, welche das Aufnahmegewinde für die Gewindeeinsätze schneidet, ohne das Originalgewinde vorher aufzubohren.

Special-Tap for Spark-Plug-Repair. Pilot Nose taps have been developed for the repair of damaged sparking plug threads without the need for additional drilling.

Mf	Ø1	Ø2	Ø3	L1	L2	L3	mm	HSS	
Mf 14 x 1,25	14,00	15,60	12,00	10,0	45,0	90,0	9,20	Code	Stk. pcs.
								47407	1



Zündkerze Spark plug

Anwendung

Für die Reparatur von Zündkerzengewinden ist ein spezieller Gewindebohrer entwickelt worden. Die besondere Form der Keilprofilnase ermöglicht das alte Gewinde zu reparieren, ohne es vorher aufzubohren. Die Spitze (Nase) des Gewindebohrers nutzt das Originalgewinde als Führung. Dahinter befinden sich Schneiden (Keilform), welche das Gewinde aufbohren. Der zweite Gewindeschneidbereich des Bohrers schneidet das Aufnahmegewinde, um anschließend die Gewindeeinsätze eindrehen zu können.

Application

Pilot Nose taps have been developed for the repair of damaged sparking plug threads without the need for additional drilling. This type of tap uses the original thread to guide the tap. It has reamer faces behind the pilot thread which cut the hole to size prior to tapping of the wire insert thread form. They are simple and easy to use and in 1 single operation ensure that the wire insert thread is concentrically aligned to the original thread. Tap creates an oversized thread for use with thread inserts.



Einbauwerkzeug Fitting-Tool



Einbauwerkzeug aus Werkzeugstahl zum Eindrehen der Gewindeeinsätze.

Fitting-Tool to screw in the thread inserts.

No.	M	Mf	HSS	
			Code	Stk. pcs.
No.02	M 2 x 0,40		47202	1
No.03	M 2,5 x 0,45		47203	1
No.04	M 3 x 0,50		47204	1
No.05	M 3,5 x 0,60		47205	1
No.06	M 4 x 0,70		47206	1
No.07			47207	1
No.08	M 5 x 0,80		47208	1
No.09	M 6 x 1,00		47209	1
No.10	M 7 x 1,00		47210	1
No.11	Mf 8 x 1,00		47211	1
	M 8 x 1,25			
No.12	M 9 x 1,25		47212	1
No.13	Mf 10 x 1,00		47213	1
	Mf 10 x 1,25			
	M 10 x 1,50			
No.14	M 11 x 1,50		47214	1
No.15	Mf 12 x 1,00		47215	1
	Mf 12 x 1,25			
	Mf 12 x 1,50			
	M 12 x 1,75			
No.16	Mf 14 x 1,00		47216	1
	Mf 14 x 1,25			
No.17	Mf 14 x 1,50		47217	1
	M 14 x 2,00			
No.18	Mf 16 x 1,50		47218	1
	M 16 x 2,00			
No.19	Mf 18 x 1,50		47219	1
	Mf 18 x 2,00			
	M 18 x 2,50			
No.20	Mf 20 x 1,50		47220	1
	Mf 20 x 2,00			
	M 20 x 2,50			
No.21	Mf 22 x 1,50		47221	1
	Mf 22 x 2,00			
	M 22 x 2,50			
No.22	Mf 24 x 1,50		47222	1
	Mf 24 x 2,00			
	M 24 x 3,00			

Zapfenbrecher Pin-Breaker



Zapfenbrecher zum Entfernen der Mitnehmerzapfen in Gewindeeinsätzen.

Pin-Breaker to remove the drive stub of the the thread insert.



No.	M	Mf	HSS	
			Code	Stk. pcs.
No.02	M 2 x 0,40		47302	1
No.03	M 2,5 x 0,45		47303	1
No.04	M 3 x 0,50		47304	1
No.05	M 3,5 x 0,60		47305	1
No.06	M 4 x 0,70		47306	1
No.07			47307	1
No.08	M 5 x 0,80		47308	1
No.09	M 6 x 1,00		47309	1
No.10	M 7 x 1,00		47310	1
No.11	Mf 8 x 1,00		47311	1
	M 8 x 1,25			
No.12	M 9 x 1,25		47312	1
No.13	Mf 10 x 1,00		47313	1
	Mf 10 x 1,25			
	M 10 x 1,50			
No.14	M 11 x 1,50		47314	1
No.15	Mf 12 x 1,00		47315	1
	Mf 12 x 1,25			
	Mf 12 x 1,50			
	M 12 x 1,75			
No.16	Mf 14 x 1,00		47316	1
	Mf 14 x 1,25			
	Mf 14 x 1,50			
	M 14 x 2,00			
No.17	Mf 16 x 1,50		47317	1
	M 16 x 2,00			
No.18	Mf 18 x 1,50		47318	1
	Mf 18 x 2,00			
	M 18 x 2,50			
No.19	Mf 20 x 1,50		47319	1
	Mf 20 x 2,00			
	M 20 x 2,50			
No.20	Mf 22 x 1,50		47320	1
	Mf 22 x 2,00			
	M 22 x 2,50			
No.21	Mf 24 x 1,50		47321	1
	Mf 24 x 2,00			
	M 24 x 3,00			



Spiralbohrer | Twist Drills DIN 338 | Typ N | HSS-G

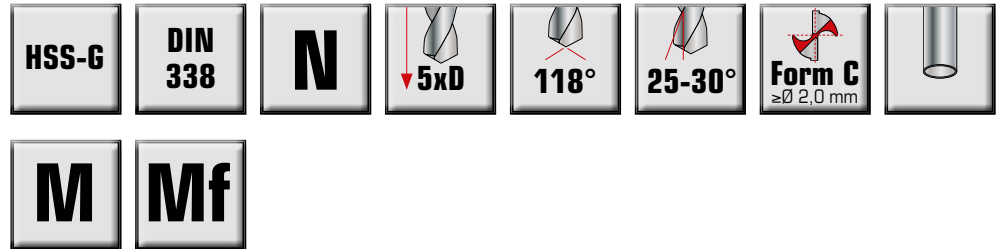

Der leistungsstarke, komplett geschliffene Spiralbohrer aus Hochleistungs-Schnellarbeitsstahl verfügt über eine erhöhte Rundlaufgenauigkeit. Beschädigtes Gewinde wird mit dem Spiralbohrer aufgebohrt.

This high capacity, complete ground twist drill bit made of high performance high speed steel has increased true running accuracy. Drill open the damaged threads with the twist drill.

Ø	M	Mf	HSS-G	
			Code	Stk. pcs.
2,10	M 2 x 0,40		32121	10
2,40			32125	10
2,60	M 2,5 x 0,45		32127	10
3,00			32132	10
3,20	M 3 x 0,50		32134	10
3,40			32137	10
3,70	M 3,5 x 0,60		32140	10
4,20	M 4 x 0,70		32146	10
4,40			32149	10
5,10			32157	10
5,20	M 5 x 0,80		32158	10
5,70			32164	10
6,30	M 6 x 1,00		32172	10
6,60			32175	10
6,70			32176	10
7,30	M 7 x 1,00		32184	10
8,20			32194	10
8,30	Mf 8 x 1,00		32196	10
	M 8 x 1,25			
9,30	M 9 x 1,25		32208	10
9,80			32214	10
9,90			32215	10
10,30	Mf 10 x 1,00		32219	10
	Mf 10 x 1,25			
10,40	M 10 x 1,50		32220	10
11,40	M 11 x 1,50		32230	5
11,50			32231	5
11,60			32232	5
12,30	Mf 12 x 1,00		32239	5
	Mf 12 x 1,25			
12,40	Mf 12 x 1,50		32240	5
	M 12 x 1,75			
13,00			32246	5



Spiralbohrer | Twist Drills DIN 338 | Typ N | HSS-G reduzierter Schaft | reduced shank

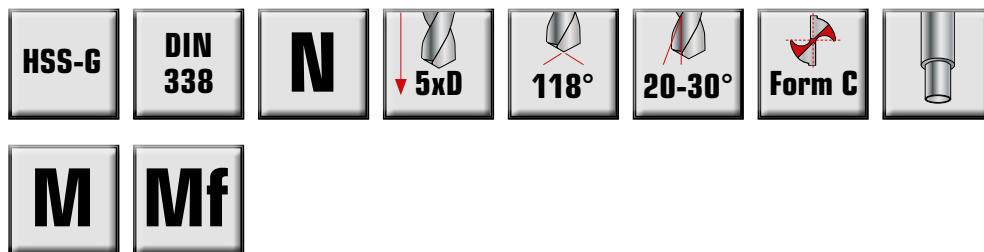

NEU

Ideal geeignet zum Bohren größerer Bohrdurchmesser mit allen gängigen Bohrmaschinen mit einem Spannfutter bis 13,0 mm. Beschädigtes Gewinde wird mit dem Spiralbohrer aufgebohrt.



Ideally suitable for drilling larger drilling diameters on all commonly-used drilling machines with a clamping chuck up to 13,0 mm. Drill open the damaged threads with the twist drill.

Ø	M	Mf	HSS-G	
			Code	Stk. pcs.
14,30		Mf 14 x 1,00	47501	1
14,40		Mf 14 x 1,25	47502	1
		Mf 14 x 1,50		
14,50		M 14 x 2,00	38239	1
14,80			47503	1
16,25			47504	1
16,40		Mf 16 x 1,50	47505	1
16,50		M 16 x 2,00	38243	1
16,70			47506	1
18,50		Mf 18 x 1,50	38247	1
		Mf 18 x 2,00		
18,60		M 18 x 2,50	47507	1
19,50			38249	1
19,75			47508	1
20,00			38250	1
20,50		Mf 20 x 1,50	47509	1
		Mf 20 x 2,00		
20,60		M 20 x 2,50	47510	1
22,50		Mf 22 x 1,50	47511	1
		Mf 22 x 2,00		
22,60		M 22 x 2,50	47512	1
22,75			47513	1
23,00			47514	1
24,50		Mf 24 x 1,50	47515	1
		Mf 24 x 2,00		
24,75		M 24 x 3,00	47516	1
26,00			47517	1
26,25			47518	1
26,50			47519	1



Technische Daten | Technical Data

Technischer Teil • Technical Part

M	Mf	 mm					 mm					 mm				
		1,0xD	1,5xD	2,0xD	2,5xD	3,0xD	1,0xD	1,5xD	2,0xD	2,5xD	3,0xD	1,0xD	1,5xD	2,0xD	2,5xD	3,0xD
M 2 x 0,40		3,80	4,80	5,80	6,80	7,80	3,40	4,40	5,40	6,40	7,40	2,00	3,00	4,00	5,00	6,00
M 2,5 x 0,45		4,52	5,77	7,02	8,27	9,52	4,07	5,32	6,57	7,82	9,07	2,50	3,75	5,00	6,25	7,50
M 3 x 0,50		5,25	6,75	8,25	9,75	11,25	4,75	6,25	7,75	9,25	10,75	3,00	4,50	6,00	7,50	9,00
M 3,5 x 0,60		6,20	7,95	9,70	11,45	13,20	5,60	7,35	9,10	10,85	12,60	3,50	5,25	7,00	8,75	10,50
M 4 x 0,70		7,15	9,15	11,15	13,15	15,15	6,45	8,45	10,45	12,45	14,45	4,00	6,00	8,00	10,00	12,00
M 5 x 0,80		8,60	11,10	13,60	16,10	18,60	7,80	10,30	12,80	15,30	17,80	5,00	7,50	10,00	12,50	15,00
M 6 x 1,00		10,50	13,50	16,50	19,50	22,50	9,50	12,50	15,50	18,50	21,50	6,00	9,00	12,00	15,00	18,00
M 7 x 1,00		11,50	15,00	18,50	22,00	25,50	10,50	14,00	17,50	21,00	24,50	7,00	10,50	14,00	17,50	21,00
Mf 8 x 1,00		12,50	16,50	20,50	24,50	28,50	11,50	15,50	19,50	23,50	27,50	8,00	12,00	16,00	20,00	24,00
M 8 x 1,25		13,62	17,62	21,62	25,62	29,62	12,37	16,37	20,37	24,37	28,37	8,00	12,00	16,00	20,00	24,00
M 9 x 1,25		14,62	19,12	23,62	28,13	32,62	13,37	17,87	22,37	26,87	31,37	9,00	13,50	18,00	22,50	27,00
Mf 10 x 1,00		14,50	19,50	24,50	29,50	34,50	13,50	18,50	23,50	28,50	33,50	10,00	15,00	20,00	25,00	30,00
Mf 10 x 1,25		15,62	20,62	25,62	30,62	35,62	14,37	19,37	24,37	29,37	34,37	10,00	15,00	20,00	25,00	30,00
M 10 x 1,50		16,75	21,75	26,75	31,75	36,75	15,25	20,25	25,25	30,25	35,25	10,00	15,00	20,00	25,00	30,00
M 11 x 1,50		17,75	23,25	28,75	34,25	39,75	16,25	21,75	27,25	32,75	38,25	11,00	16,50	22,00	27,50	33,00
Mf 12 x 1,25		17,62	23,62	29,62	35,62	41,62	16,37	22,37	28,37	34,37	40,37	12,00	18,00	24,00	30,00	36,00
Mf 12 x 1,50		18,75	24,75	30,75	36,75	42,75	17,25	23,25	29,25	35,25	41,25	12,00	18,00	24,00	30,00	36,00
M 12 x 1,75		19,87	25,87	31,87	37,87	43,87	18,12	24,12	30,12	36,12	42,12	12,00	18,00	24,00	30,00	36,00
Mf 14 x 1,25		19,62	26,62	33,62	40,62	47,62	18,37	25,37	32,37	39,37	46,37	14,00	21,00	28,00	35,00	42,00
Mf 14 x 1,50		20,75	27,75	34,75	41,75	48,75	19,25	26,25	33,25	40,25	47,25	14,00	21,00	28,00	35,00	42,00
M 14 x 2,00		23,00	30,00	37,00	44,00	51,00	21,00	28,00	35,00	42,00	49,00	14,00	21,00	28,00	35,00	42,00
Mf 16 x 1,50		22,75	30,75	38,75	46,75	54,75	21,25	29,25	37,25	45,25	53,25	16,00	24,00	32,00	40,00	48,00
M 16 x 2,00		25,00	33,00	41,00	49,00	57,00	23,00	31,00	39,00	47,00	55,00	16,00	24,00	32,00	40,00	48,00
Mf 18 x 2,00		27,00	36,00	45,00	54,00	63,00	25,00	34,00	43,00	52,00	61,00	18,00	27,00	36,00	45,00	54,00
M 18 x 2,50		29,25	38,25	47,25	56,25	65,25	26,75	35,75	44,75	53,75	62,75	18,00	27,00	36,00	45,00	54,00
Mf 20 x 1,50		26,75	36,75	46,75	56,75	66,75	25,25	35,25	45,25	55,25	65,25	20,00	30,00	40,00	50,00	60,00
Mf 20 x 2,00		29,00	39,00	49,00	59,00	69,00	27,00	37,00	47,00	57,00	67,00	20,00	30,00	40,00	50,00	60,00
M 20 x 2,50		31,25	41,25	51,25	61,25	71,25	28,75	38,75	48,75	58,75	68,75	20,00	30,00	40,00	50,00	60,00
Mf 22 x 1,50		28,75	39,75	50,75	61,75	72,75	27,25	38,25	49,25	60,25	71,25	22,00	33,00	44,00	55,00	66,00
Mf 22 x 2,00		31,00	42,00	53,00	64,00	75,00	29,00	40,00	51,00	62,00	73,00	22,00	33,00	44,00	55,00	66,00
M 22 x 2,50		33,25	44,25	55,25	66,25	77,25	30,75	41,75	52,75	63,75	74,75	22,00	33,00	44,00	55,00	66,00
Mf 24 x 2,00		33,00	45,00	57,00	69,00	81,00	31,00	43,00	55,00	67,00	79,00	24,00	36,00	48,00	60,00	72,00
M 24 x 3,00		37,50	49,50	61,50	73,50	85,50	34,50	46,50	58,50	70,50	82,50	24,00	36,00	48,00	60,00	72,00

Legende | Legend

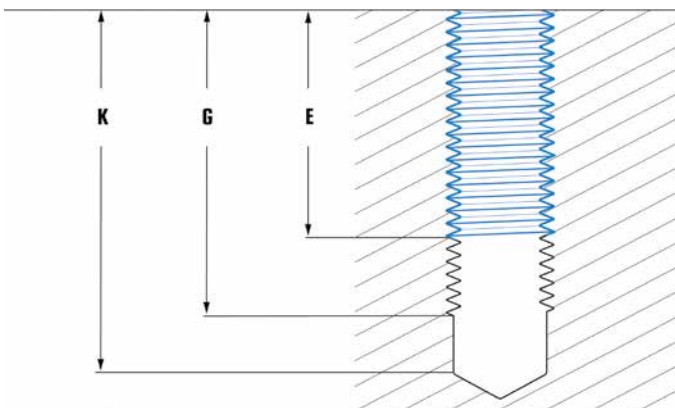

K: Min. Bohrtiefe des Kernloches
K: Min. drilling length of the core hole



G: Gewindetiefe (inkl. Anschnitt)
G: Tapping length (incl. chamfer)



E: Einbaulänge des Gewindeeinsatzes
E: Installation length of the insert

Empfohlene Kernlochmaße für die Proficoil Gewindereparatur

Recommended Tapping Drill Sizes Proficoil

M	Mf	Ø
M 2 x 0,40		2,10
M 2,5 x 0,45		2,60
M 3 x 0,50		3,20
M 3,5 x 0,60		3,70
M 4 x 0,70		4,20
M 5 x 0,80		5,20
M 6 x 1,00		6,30
M 7 x 1,00		7,30
Mf 8 x 1,00		8,30
M 8 x 1,25		8,30
M 9 x 1,25		9,30
Mf 10 x 1,00		10,30
Mf 10 x 1,25		10,30
M 10 x 1,50		10,40
M 11 x 1,50		11,40
Mf 12 x 1,00		12,30
Mf 12 x 1,25		12,30
Mf 12 x 1,50		12,40
M 12 x 1,75		12,40
Mf 14 x 1,00		14,30
Mf 14 x 1,25		14,40
Mf 14 x 1,50		14,40
M 14 x 2,00		14,50
Mf 16 x 1,50		16,40
M 16 x 2,00		16,50
Mf 18 x 1,50		18,50
Mf 18 x 2,00		18,50
M 18 x 2,50		18,60
Mf 20 x 1,50		20,50
Mf 20 x 2,00		20,50
M 20 x 2,50		20,60
Mf 22 x 1,50		22,50
Mf 22 x 2,00		22,50
M 22 x 2,50		22,60
Mf 24 x 1,50		24,50
Mf 24 x 2,00		24,50
M 24 x 3,00		24,75

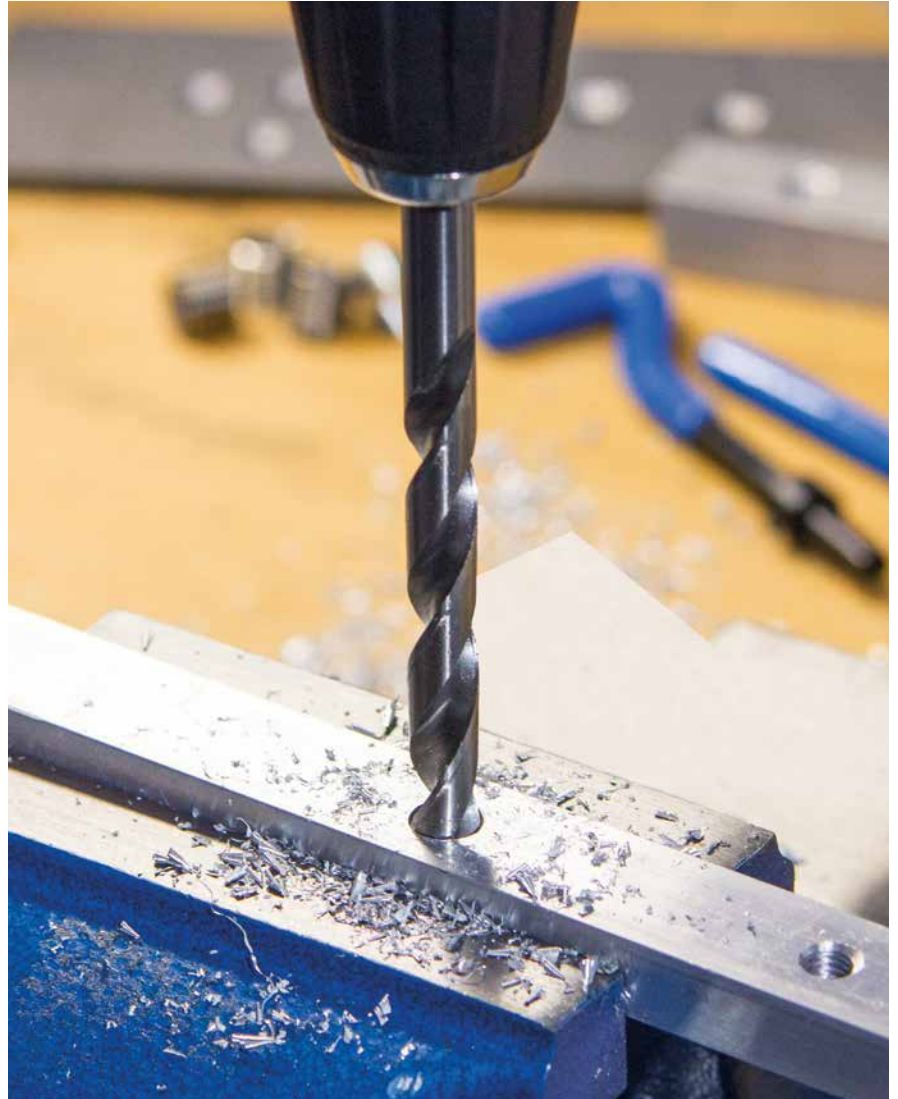



KERNBOHRER CORE DRILLS

EXACT®

Kernbohrer Schnittiefe 30 mm

331

Core Drills Cutting depth 30 mm

- HSS
- HSS-Co5
- HSS TiAlN

Kernbohrer Schnittiefe 55 mm

332

Core Drills Cutting depth 55 mm

- HSS
- HSS-Co5
- HSS TiAlN

Sets Schnittiefe 30 mm / 55 mm

333

Sets Cutting depth 30mm / 55mm

- HSS
- HSS TiAlN

Auswerferstift

333

Ejector Pin

Produktinformation Product information

Vorteile | Advantages

- | | |
|---|---|
| <ul style="list-style-type: none"> ■ Optimierte Schneidengeometrie
erhöht die Zerspanleistung und verringert die Schnittkräfte ■ U-förmige Geometrie der Auslückung
verbessert die Spanabfuhr und verringert die thermische Belastung des HSS-Kernbohrers, da die entstehende Wärme größtenteils mit dem Span abgeführt wird ■ Spiralförmig verlaufende Führungsfasern
verringern die Reibung zwischen HSS-Kernbohrer und Werkstück ■ Spanwinkel sind für den universellen Einsatz
in verschiedenen Stahlsorten ausgelegt | <ul style="list-style-type: none"> ■ Optimized cutting edge geometry
increased cutting performance and reduce cutting forces ■ U-shaped recesses
improved removal of chips and reduces the thermal load on the HSS core drill as the heat created in cutting is removed with the chips to a very great extent ■ Spiral-shaped guide chamfers
reduction of the friction between HSS core drill and your workpiece ■ Effective cutting angle
designed for universal use in various sorts of steel |
|---|---|



Technische Information | Technical Information

HSS	Kernbohrer HSS	Core Drills HSS
	Material: Hochleistungsschnell-Stahl Anwendung: Für Stahl, Stahlguss, Bunt- und Leichtmetalle	Material: High-speed-steel Application: For steel, cast iron, non-ferrous and light metals
HSS Co5	Kernbohrer HSS Co5	Core Drills HSS Co5
	Material: aus kobaltlegiertem Hochleistungsschnell-Stahl mit höherer Wärme- härtebeständigkeit Anwendung: Besonders geeignet für schwer spanbare Materialien: unlegierte und legierte Stähle bis 1.200 N/mm ² , Warm- und Kalt- arbeitsstähle, Vergütungs- und Einsatzstähle	Material: made of cobalt alloyed high-speed-steel with increased heat resistance Application: Especially suitable for materials that are difficult to cut: unalloyed an alloyed steel up to 1.200 N/mm ² , hot and cold-working steel, reinforced and case-hardened steel
HSS TiAIN	Kernbohrer HSS TiAIN	Core Drills HSS TiAIN
	Oberflächenhärte: ca. 3.000 HV Temperaturbeständig: bis 900° C Kühlung: Kein Kühlmittel notwendig Anwendung: Besonders geeignet für unlegierte und legierte Stähle bis 1.200 N/mm ² , hochchromlegierte Stähle, wie z.B. V2A und VA, sowie Stahlguß und zähes Messing Vorteile: <ul style="list-style-type: none"> • Hohe themische und chemische Stabilität • Optimale Standzeiten • Höhere Schnittwerte 	Surface hardness: approx. 3.000 HV Temperature resistant: up to 900° C Cooling: Not necessary Application: Especially suitable for unalloyed an alloyed steel up to 1.200 N/mm ² , high-alloyed chromium steel such as stainless and acidresistant steel, as well as cast iron and brass Advantages: <ul style="list-style-type: none"> • High thermal and chemical stability • Longer tool-life • Better cutting values

Kernbohrer mit Weldonschaft (3/4")

Core Drills with Weldon shank (3/4")

EXACT
PRÄZISIONSWERKZEUGE

Schnitttiefe 30 mm | Cutting depth 30 mm

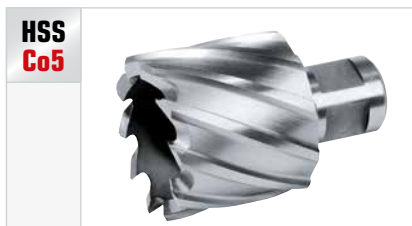







Technische Information

- HSS / HSS Co5 / HSS TiAIN (Materialinformation: Seite 8)
- CBN geschliffen
- Weldonschaft 19 mm (3/4")
- rechtsschneidend

Technical Information

- HSS / HSS Co5 / HSS TiAIN (Material information: page 8)
- CBN ground
- 19 mm Weldon shank (3/4")
- right hand cutting

						
12,0	19,0	30,0	63,0	33012	33112	33212
13,0	19,0	30,0	63,0	33013	33113	33213
14,0	19,0	30,0	63,0	33014	33114	33214
15,0	19,0	30,0	63,0	33015	33115	33215
16,0	19,0	30,0	63,0	33016	33116	33216
17,0	19,0	30,0	63,0	33017	33117	33217
18,0	19,0	30,0	63,0	33018	33118	33218
19,0	19,0	30,0	63,0	33019	33119	33219
20,0	19,0	30,0	63,0	33020	33120	33220
21,0	19,0	30,0	63,0	33021	33121	33221
22,0	19,0	30,0	63,0	33022	33122	33222
23,0	19,0	30,0	63,0	33023	33123	33223
24,0	19,0	30,0	63,0	33024	33124	33224
25,0	19,0	30,0	63,0	33025	33125	33225
26,0	19,0	30,0	63,0	33026	33126	33226
27,0	19,0	30,0	63,0	33027	33127	33227
28,0	19,0	30,0	63,0	33028	33128	33228
29,0	19,0	30,0	63,0	33029	33129	33229
30,0	19,0	30,0	63,0	33030	33130	33230
31,0	19,0	30,0	63,0	33031	33131	33231
32,0	19,0	30,0	63,0	33032	33132	33232
33,0	19,0	30,0	63,0	33033	33133	33233
34,0	19,0	30,0	63,0	33034	33134	33234
35,0	19,0	30,0	63,0	33035	33135	33235
36,0	19,0	30,0	63,0	33036	33136	33236
37,0	19,0	30,0	63,0	33037	33137	33237
38,0	19,0	30,0	63,0	33038	33138	33238
39,0	19,0	30,0	63,0	33039	33139	33239
40,0	19,0	30,0	63,0	33040	33140	33240
41,0	19,0	30,0	63,0	33041	33141	33241
42,0	19,0	30,0	63,0	33042	33142	33242
43,0	19,0	30,0	63,0	33043	33143	33243
44,0	19,0	30,0	63,0	33044	33144	33244
45,0	19,0	30,0	63,0	33045	33145	33245
46,0	19,0	30,0	63,0	33046	33146	33246
47,0	19,0	30,0	63,0	33047	33147	33247
48,0	19,0	30,0	63,0	33048	33148	33248
49,0	19,0	30,0	63,0	33049	33149	33249
50,0	19,0	30,0	63,0	33050	33150	33250
51,0	19,0	30,0	63,0	33051	33151	33251
52,0	19,0	30,0	63,0	33052	33152	33252
53,0	19,0	30,0	63,0	33053	33153	33253
54,0	19,0	30,0	63,0	33054	33154	33254
55,0	19,0	30,0	63,0	33055	33155	33255
56,0	19,0	30,0	63,0	33056	33156	33256
57,0	19,0	30,0	63,0	33057	33157	33257
58,0	19,0	30,0	63,0	33058	33158	33258
59,0	19,0	30,0	63,0	33059	33159	33259
60,0	19,0	30,0	63,0	33060	33160	33260

Kernbohrer mit Weldonschaft (3/4")

Core Drills with Weldon shank (3/4")

EXACT
PRÄZISIONSWERKZEUGE

Schnitttiefe 55 mm | Cutting depth 55 mm









Technische Information

- HSS / HSS Co5 / HSS TiAIN (Materialinformation: Seite 8)
- CBN geschliffen
- Weldonschaft 19 mm (3/4")
- rechtsschneidend





Technical Information

- HSS / HSS Co5 / HSS TiAIN (Material information: page 8)
- CBN ground
- 19 mm Weldon shank (3/4")
- right hand cutting

						
12,0	19,0	55,0	88,0	39212	39312	39412
13,0	19,0	55,0	88,0	39213	39313	39413
14,0	19,0	55,0	88,0	39214	39314	39414
15,0	19,0	55,0	88,0	39215	39315	39415
16,0	19,0	55,0	88,0	39216	39316	39416
17,0	19,0	55,0	88,0	39217	39317	39417
18,0	19,0	55,0	88,0	39218	39318	39418
19,0	19,0	55,0	88,0	39219	39319	39419
20,0	19,0	55,0	88,0	39220	39320	39420
21,0	19,0	55,0	88,0	39221	39321	39421
22,0	19,0	55,0	88,0	39222	39322	39422
23,0	19,0	55,0	88,0	39223	39323	39423
24,0	19,0	55,0	88,0	39224	39324	39424
25,0	19,0	55,0	88,0	39225	39325	39425
26,0	19,0	55,0	88,0	39226	39326	39426
27,0	19,0	55,0	88,0	39227	39327	39427
28,0	19,0	55,0	88,0	39228	39328	39428
29,0	19,0	55,0	88,0	39229	39329	39429
30,0	19,0	55,0	88,0	39230	39330	39430
31,0	19,0	55,0	88,0	39231	39331	39431
32,0	19,0	55,0	88,0	39232	39332	39432
33,0	19,0	55,0	88,0	39233	39333	39433
34,0	19,0	55,0	88,0	39234	39334	39434
35,0	19,0	55,0	88,0	39235	39335	39435
36,0	19,0	55,0	88,0	39236	39336	39436
37,0	19,0	55,0	88,0	39237	39337	39437
38,0	19,0	55,0	88,0	39238	39338	39438
39,0	19,0	55,0	88,0	39239	39339	39439
40,0	19,0	55,0	88,0	39240	39340	39440
41,0	19,0	55,0	88,0	39241	39341	39441
42,0	19,0	55,0	88,0	39242	39342	39442
43,0	19,0	55,0	88,0	39243	39343	39443
44,0	19,0	55,0	88,0	39244	39344	39444
45,0	19,0	55,0	88,0	39245	39345	39445
46,0	19,0	55,0	88,0	39246	39346	39446
47,0	19,0	55,0	88,0	39247	39347	39447
48,0	19,0	55,0	88,0	39248	39348	39448
49,0	19,0	55,0	88,0	39249	39349	39449
50,0	19,0	55,0	88,0	39250	39350	39450
51,0	19,0	55,0	88,0	39251	39351	39451
52,0	19,0	55,0	88,0	39252	39352	39452
53,0	19,0	55,0	88,0	39253	39353	39453
54,0	19,0	55,0	88,0	39254	39354	39454
55,0	19,0	55,0	88,0	39255	39355	39455
56,0	19,0	55,0	88,0	39256	39356	39456
57,0	19,0	55,0	88,0	39257	39357	39457
58,0	19,0	55,0	88,0	39258	39358	39458
59,0	19,0	55,0	88,0	39259	39359	39459
60,0	19,0	55,0	88,0	39260	39360	39460





Sets 30 mm / 55 mm | Sets 30 mm / 55 mm



					
Ø 12,0 / 14,0 / 16,0 / 18,0 / 20,0 / 22,0 mm	30,0	63,0	33011	33211	
Ø 12,0 / 14,0 / 16,0 / 18,0 / 20,0 / 22,0 mm	55,0	88,0	34011	34211	

Auswerferstift | Ejector Pin



			
6,35	30,0	77,0	33100
6,35	55,0	102,0	34100

Technische Information

Auswerferstift für Kernbohrer mit Weldonchaft 3/4"

Technical Information

Ejector pins for core drills with Weldon shank 3/4"

Produktinformation | Product information

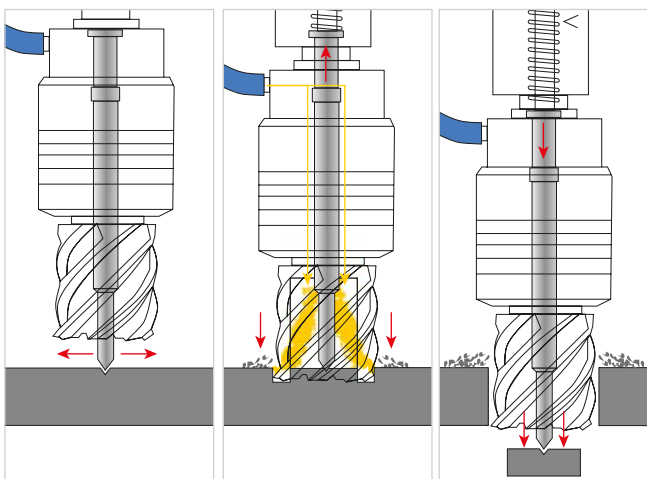

Funktion des Auswerferstiftes

Zentrieren:

Der Auswerferstift wird genau auf dem Körner positioniert. Magnet einschalten. Die Maschine und das Werkzeug befinden sich in Bohrposition.

Dosieren:

Mit der automatischen Innenschmierung wird Schneidöl über den Auswerferstift an die Bohrspitze geführt. Genau richtig dosiert.

Auswerfen:

Der mit einer Feder vorgespannte Auswerferstift drückt den Bohrkern in der Endphase der Bohrung aus dem Bohrloch heraus.

Centering:

The ejector pin is placed exactly on the centre punch. Switching on magnet. The machine and the tool are into drilling position.

Dosing:

With the automatic inside lubrication cutting oil is led to the boring tool about the ejector pin. Measured out absolutely correct.

Ejecting:

The ejector pin prestressed with a feather pushes the drill core out of the drill hole in the final stages of the drilling.





TECHNISCHER TEIL
TECHNICAL PART

Stahlqualitäten	336
CBN-tiefschleifen	336
Anwendung Bleeschälbohrer	336
Anwendung Stufenbohrer	336
Anwendung Kegelsenker	337
Toleranzen Gewinde	337
Richtwerte zum Gewindeschneiden	337
Härtevergleichstabelle	338
Umrechentabelle	339
Umdrehungsvorgaben Bi-Metall Lochsägen	339
Sonderanfertigungen	340
Bestellhinweise	342
Allgemeine Geschäftsbedingungen	345

Stahlqualitäten

HSS

HSS (Hochleistungsschnell-Stahl)

- Weitere Bezeichnungen: 1.3343 (DIN) / M2 (USA) / BM2 (UK) / SKH51 (Japan) / HS 6-5-2 (EN)
- Zusammensetzung:

C	Cr	Mo	W	V
0,9	4,2	5,0	6,4	1,8

HSS-E

HSS-E (Hochleistungsschnell-Stahl Klasse-E)

- Weitere Bezeichnungen: 1.3243 (DIN) / M35 (USA) / BM35 (UK) / SKH55 (Japan) / HS 6-5-2-5 (EN)
- Klasse E = 5 % Kobaltanteil
- Zusammensetzung:

C	Cr	Mo	W	Co	V
0,93	4,2	5,0	6,4	5,0	1,8

PM

PM (Pulvermetallurgisches Metall)

- Wir verwenden wahlweise ASP2030 (Erasteel) oder Vanadis30 (Böhler - Uddeholm)
- Zusammensetzung:

C	Cr	Mo	W	Co	V
1,18	4,2	5,0	6,4	8,5	3,1

Anwendung PM – Senker

- Drehzahl: (100 – 400 U/min)
- Vorschub: $\varnothing 6,3 - 12,4 = 0,05 - 0,10$
 $\varnothing 16,5 - 25,0 = 0,15 - 0,20$
Senkung nach Möglichkeit in einem Zug durchführen
- Kühlung: Gute Kühlung mit Emulsion
VA + HARDOX mit „Fetter“ Emulsion

CBN-Tiefschleifen

CBN steht für Bornitrid. Bornitrid ist neben Diamant der härteste bekannte Stoff. Bornitrid ist für die Bearbeitung von HSS + HSS-E Stählen der beste geeignete Werkstoff. CBN-Tiefschleifen garantiert für unsere Werkzeuge:

- Höchste Oberflächengüte
- Höhere Maßgenauigkeit
- Längere Standzeiten

Anwendung von Bleeschälbohrern

EXACT-Schälbohrer wurden konzipiert für das gratfreie Bohren bei Blechen, Rohren und Profilen. Das Werkzeug ist geeignet für Materialstärken ab 0,1 mm. Die robuste Konstruktion weist einen großen Spanwinkel, einen kleinen Freiwinkel und einen Spezialhinterschliff auf.

EXACT-Schälbohrer können auf regelbaren Handbohrmaschinen oder auf Ständerbohrmaschinen eingesetzt werden. Es ist kein Ankönnen nötig – Bohrer verläuft nicht.

Drehzahlrichtwerte für EXACT-Schälbohrer

Material	Bau- stahl	CrNi- Stahl	Ne- Metall	Kunststoffe duroplastisch thermo- plastisch
Material- stärke Größe	0,1-2 mm n=U/min.	0,1-1 mm n=U/min.	0,1-5 mm n=U/min.	bis 10 mm n=U/min.
1	3-14	800 - 500	600 - 400	2000 - 1500
2	8-20	600 - 300	400 - 200	1500 - 800
3	16-30	400 - 200	200 - 100	1000 - 500
4	26-40	300 - 150	100 - 80	500 - 300

Beim Bohren ist unbedingt auf gute Schmierung zu achten.

Material	Bau- stahl	CrNi- Stahl	Ne- Metall	Kunststoffe duroplastisch thermo- plastisch
Material- stärke Größe	0,1-2 mm n=U/min.	0,1-1 mm n=U/min.	0,1-5 mm n=U/min.	bis 10 mm n=U/min.
5	36-50	200 - 100	80 - 50	30 - 200
6	46-60	100 - 50	50	200 - 100
A	4-22,5	450 - 250	200 - 100	1000 - 700
L	4-30	400 - 200	200 - 100	1000 - 500

Anwendung von Stufenbohrern

Mit EXACT-Stufenbohrern werden zylindrische Bohrungen erzeugt, die gleichzeitig von der nächsten Stufe entgratet werden. Ein EXACT-Stufenbohrer kann einen ganzen Spiralbohrersatz ersetzen. Anbohren und Ankönnen entfallen, der EXACT-Stufenbohrer kömmt selbst an. Der gewünschte Lochdurchmesser läßt sich durch Zählen der einzelnen Stufen leicht bestimmen bzw. kann durch unsere Laserskalierung (DBGM) abgelesen werden.

Durchmessern können z.B. exakte Löcher für PG-Verschraubungen hergestellt werden.

EXACT-Stufenbohrer können auf regelbaren Handbohrmaschinen eingesetzt werden. Wir empfehlen aber auf stationären Bohrmaschinen zu bohren. Die Werkzeuge sind axial und radial hinterschliffen und können vor der Schneidbrust nachgeschliffen werden.

Durch verschiedene Baugrößen mit genau abgestimmten

Beim Bohren ist unbedingt auf gute Schmierung zu achten.

Drehzahlrichtwerte für EXACT-Stufenbohrer

∅	Bau- stahl	CrNi- Stahl	Ne- Metall	Kunststoffe
4 - 12 mm	800 - 500	400 - 250	1500 - 1000	2000 - 1500
14 - 20 mm	500 - 300	250 - 150	1000 - 600	1500 - 800
21 - 30 mm	300 - 200	150 - 100	600 - 400	800 - 500

∅	Bau- stahl	CrNi- Stahl	Ne- Metall	Kunststoffe
30 - 40 mm	200 - 150	100 - 70	400 - 300	500 - 350
40 - 50 mm	150 - 100	70 - 50	300 - 200	350 - 250
50 - 60 mm	100 - 50	50	200 - 100	250 - 150

Toleranzen

Innengewinde

2B
6H

Toleranz 2B / 6H = ISO2 Normale Gewindeverbindung

7H
6G

Toleranz 7H + 6G = ISO3 Gewindeverbindung mit Spiel

7G

Toleranz 7G = Vorbeugend für Verzug durch Wärmebehandlung

Außengewinde

2A
6g

Toleranz 2A + 6g = Normale Gewindeverbindung

Kegelsenker / Senk Bits

Weisen Span- und Freiwinkel auf, die nahezu bei allen in der Metallbearbeitung vorkommenden Werkstoffen saubere und glatte Senkungen erzeugen. Sollten in Extremfällen die Ergebnisse nicht ausreichend sein, so sind wir gerne bereit, durch Senkversuche verbesserte Lösungen anzubieten.

Beim Einsatz unserer EXACT-Kegelsenker und EXACT-Senk-Bits werden erfahrungsgemäß bessere Werte bei kleinen Drehzahlen und größeren Vorschüben erzeugt.

Werkstoff	Schnittgeschwindigkeit	Vorschub S (mm/U) für Senker						Kühl und Schmiermittel
		5	10	16	25	40	63	
Stahl unlegiert bis 700 N/mm ²	20 - 28	0,05 - 0,7	0,09 - 0,12	0,12 - 0,16	0,16 - 0,2	0,2 - 0,25	0,25 - 0,36	Emulsion
Stahl unlegiert bis 900 N/mm ²	18 - 25	0,04 - 0,05	0,06 - 0,08	0,09 - 0,12	0,12 - 0,16	0,16 - 0,2	0,2 - 0,28	Emulsion
Stahl unlegiert bis 1250 N/mm ²	6 - 10	manuell	0,04 - 0,06	0,07 - 0,09	0,09 - 0,11	0,11 - 0,14	0,14 - 0,18	Emulsion
Stahl nicht rostend	5 - 12	manuell	0,04 - 0,06	0,07 - 0,09	0,09 - 0,11	0,11 - 0,14	0,14 - 0,18	Emulsion
Grauguss bis 200 HB	14 - 25	0,07 - 0,1	0,12 - 0,16	0,16 - 0,2	0,2 - 0,25	0,25 - 0,32	0,25 - 0,32	trocken
Grauguss bis 240 HB	8 - 14	0,06 - 0,09	0,1 - 0,12	0,12 - 0,16	0,16 - 0,2	0,2 - 0,25	0,25 - 0,36	trocken
Kupfer- und Cu-Legierung	36 - 50	0,04 - 0,09	0,1 - 0,12	0,12 - 0,16	0,16 - 0,2	0,2 - 0,25	0,25 - 0,36	Emulsion od. Schneidöl
Messing kurzspanend MS 58	50 - 80	0,08 - 0,11	0,12 - 0,16	0,16 - 0,2	0,2 - 0,25	0,25 - 0,32	0,32 - 0,4	Emulsion od. Schneidöl
Messing langspanend MS 63	30 - 50	0,08 - 0,11	0,12 - 0,16	0,16 - 0,2	0,2 - 0,25	0,25 - 0,32	0,32 - 0,4	Emulsion od. Schneidöl
Alu-Legierung, alngspanend	40 - 80	0,08 - 0,11	0,12 - 0,16	0,16 - 0,2	0,2 - 0,25	0,25 - 0,32	0,32 - 0,4	Emulsion
Alu-Leg., kurzspanend + Silumin	25 - 50	0,06 - 0,09	0,1 - 0,12	0,12 - 0,16	0,16 - 0,2	0,2 - 0,25	0,25 - 0,36	Emulsion
Magnesium-Legierungen	60 - 100	0,1 - 0,14	0,16 - 0,2	0,2 - 0,25	0,25 - 0,32	0,32 - 0,4	0,4 - 0,5	trocken (kein Wasser)
Kunststoffe (Thermoplaste)	20 - 40	0,05 - 0,08	0,09 - 0,12	0,12 - 0,16	0,16 - 0,2	0,2 - 0,25	0,25 - 0,36	PreBluft
Kunststoffe (Duroplaste)	10 - 20	0,04 - 0,06	0,07 - 0,09	0,1 - 0,12	0,12 - 0,16	0,16 - 0,2	0,2 - 0,25	PreBluft

Richtwerte für Spanwinkel, Schnittgeschwindigkeiten, Schmier- bzw. Kühlmittel zum Gewindeschneiden

Werkstoffe Gruppe	Bezeichnungs-Beispiele	Spanwinkel	Schnittgeschwindigkeit m/min.	Schmier- und Kühlmittel
Allgemeine Baustähle	St 37, St 50	12 - 15°	8 - 15	Schneidöl, Emulsion
Automaten-Stähle	9S20K, 9SMn36			
Einsatzstähle	C10, C15, 16MnCr5			
Tiefziehbleche	St 2, St 3, SSt 4	18 - 20°	10 - 15	Schneidöl, Emulsion
Vergütungsstähle	Ck55, 42 CrMo4	8 - 12°	5 - 10	Schneidöl
Hitzebeständige Stähle	X10CrAl18, X12MnCr1812	8 - 12°	5 - 10	Schneidöl
Werkzeugstähle	C105W1, X210Cr12	6 - 10°	2 - 8	Schneidöl
Schnellarbeitsstähle	S-6-5-2, S12-1-4-5			
Rost- und säurebeständige Stähle	X20Cr13, X100CrMo13, X12CrNiS18 8	10 - 18°	5 - 10	Schneidöl
Grauguss	GG-10, GG-18, GG-25	6°	6 - 20	Schneidöl, Petroleum
Sphäroguss	GGG-42, GGG-50			
Temperguss	GTW-40, GTS-38	10 - 15°	10 - 15	Schneidöl, Emulsion
Kupfer und	Elektrolyt-Kupfer	10 - 18°	10 - 15	Schneidöl, Emulsion
Cu-Legierungen	C-Cu			
Messing kurzspanend (Ms58)	CuZn39Pb2	6°	20 - 30	Schneidöl, Emulsion
Messing langspanend (Ms63)	CuZn37	18 - 20°	10 - 15	Schneidöl, Emulsion
Bronze	RG5	4 - 8°	5 - 15	Schneidöl, Emulsion
Alu-Legierung kurzspanend	G-AlSi10 Mg wa	12 - 15°	20 - 30	Emulsion
Alu-Legierung langspanend	AlMgSi	25°	10 - 15	Emulsion
Thermoplastische Kunststoffe	PVC, Polyamid	25°	5 - 15	trocken, PreBluft
Duroplastische Kunststoffe		4 - 6°	5 - 10	trocken, PreBluft

Härtevergleichstabelle

Zugfestigkeit R _m N/mm ²	Brinellhärte		Vickershärte HV	Rockwellhärte		
	Kugleindruck mm	HB		HRB	HRC	HR 30 N
255	6,63	76,0	80	-	-	-
270	6,45	80,7	85	41,0	-	-
285	6,30	85,5	90	48,0	-	-
305	6,16	90,2	95	52,0	-	-
320	6,01	95,0	100	56,2	-	-
335	5,90	99,8	105	-	-	-
350	5,75	105	110	62,3	-	-
370	5,65	109	115	-	-	-
385	5,54	114	120	66,7	-	-
400	5,43	119	125	-	-	-
415	5,33	124	130	71,20	-	-
430	5,26	128	135	-	-	-
450	5,16	133	140	75,0	-	-
465	5,08	138	145	-	-	-
480	4,99	143	150	78,7	-	-
495	4,93	147	155	-	-	-
510	4,85	152	160	81,7	-	-
530	4,79	156	165	-	-	-
545	4,71	162	170	85,0	-	-
560	4,66	166	175	-	-	-
575	4,59	171	180	87,1	-	-
595	4,53	176	185	-	-	-
610	4,47	181	190	89,5	-	-
625	4,43	185	195	-	-	-
640	4,37	190	200	91,5	-	-
660	4,32	195	205	92,5	-	-
675	4,27	199	210	93,5	-	-
690	4,22	204	215	94,0	-	-
705	4,18	209	220	95,0	-	-
720	4,13	214	225	96,0	-	-
740	4,08	219	230	96,7	-	-
755	4,05	223	235	-	-	-
770	4,01	228	240	98,1	20,3	41,7
785	3,97	233	245	-	21,3	42,5
800	3,92	238	250	99,5	22,2	43,3
820	3,89	242	255	-	23,1	44,2
835	3,86	247	260	(101)	24,0	45,0
850	3,82	252	265	-	24,8	45,7
865	3,78	257	270	(102)	25,6	46,4
880	3,75	261	275	-	26,4	47,2
900	3,72	266	280	(104)	27,1	47,8
915	3,69	271	285	-	27,8	48,4
930	3,66	276	290	(105)	28,5	49,0
950	3,63	280	295	-	29,2	49,7
965	3,60	285	300	-	29,8	50,2
995	3,54	295	310	-	31,0	51,3
1030	3,49	304	320	-	32,2	52,3
1060	3,43	314	330	-	33,3	53,6
1095	3,39	323	340	-	34,4	54,4
1125	3,34	333	350	-	35,5	55,4
1155	3,29	342	360	-	36,6	56,4
1190	3,25	352	370	-	37,7	57,4
1220	3,21	361	380	-	38,8	58,4
1255	3,17	371	390	-	39,8	59,3
1290	3,13	380	400	-	40,8	60,2
1320	3,09	390	410	-	41,8	61,1
1350	3,06	399	420	-	42,7	61,9

Zugfestigkeit R _m N/mm ²	Brinellhärte		Vickershärte HV	Rockwellhärte		
	Kugleindruck mm	HB		HRB	HRC	HR 30 N
1385	3,02	409	430	-	43,6	62,7
1420	2,99	418	440	-	44,5	63,5
1455	2,95	428	450	-	45,3	64,3
1485	2,92	437	460	-	46,1	64,9
1520	2,89	447	470	-	46,9	65,7
1555	2,86	(456)	480	-	47,7	66,4
1595	2,83	(466)	490	-	48,4	67,1
1630	2,81	(475)	500	-	49,1	67,7
1665	2,78	(485)	510	-	49,8	68,3
1700	2,75	(494)	520	-	50,5	69,0
1740	2,73	(504)	530	-	51,1	69,5
1775	2,70	(513)	540	-	51,7	70,0
1810	2,68	(523)	550	-	52,3	70,5
1845	2,66	(532)	560	-	53,0	71,2
1880	2,63	(542)	570	-	53,6	71,7
1920	2,60	(551)	580	-	54,1	72,1
1955	2,59	(561)	590	-	54,7	72,7
1995	2,57	(570)	600	-	55,2	73,2
2030	2,54	(580)	610	-	55,7	73,7
2070	2,52	(589)	620	-	56,3	74,2
2105	2,51	(599)	630	-	56,8	74,6
2145	2,49	(608)	640	-	57,3	75,1
2180	2,47	(618)	650	-	57,8	75,5
-	-	-	660	-	58,3	75,9
-	-	-	670	-	58,8	76,4
-	-	-	680	-	59,2	76,8
-	-	-	690	-	59,7	77,2
-	-	-	700	-	60,1	77,6
-	-	-	720	-	61,0	78,8
-	-	-	740	-	61,8	79,1
-	-	-	760	-	62,5	79,7
-	-	-	780	-	63,3	80,4
-	-	-	800	-	64,0	81,1
-	-	-	820	-	64,7	81,7
-	-	-	840	-	65,3	82,2
-	-	-	860	-	65,9	82,7
-	-	-	880	-	66,4	83,1
-	-	-	900	-	67,0	83,6
-	-	-	920	-	67,5	84,0
-	-	-	940	-	68,0	84,4

Erläuterung

Zugfestigkeit	N/mm ²	R _m
Brinellhärte (Errechnet aus: HB = 0,95 · HV) (0,102 F/D ² = 30)	Durchmesser des Kugleindrucks in mm Härtezahl = $\frac{0,102 \cdot 2 F}{\pi D (D \sqrt{D^2 - \alpha^2})}$	d HB
Vickershärte	Diamantpyramide Prüfkräfte ≥ 50 N	HV
Rockwellhärte	Kugel 1,588 mm (1/16 „), Prüfgesamtkraft = 98 N Diamantkegel, Prüfgesamtkraft = 1471 N Diamantkegel, Prüfgesamtkraft = 294 N	HRB HRC HR 30 N

Umrechentabelle

Schnittgeschwindigkeit V=m/min. Gewinde- Ø	2	3	4	5	6	8	10	12	15	18	20	25	30	35	40	45	50	60	70
2	318	478	637	796	955	1274	1592	1911	2388	2864	3185	3981	4777	5570	6369	7165	7961	9549	11141
3	212	318	425	531	637	849	1062	1274	1592	1909	2123	2654	3185	3713	4246	4777	5308	6366	7427
4	159	239	318	398	478	637	796	955	1194	1432	1592	1990	2389	2785	3185	3582	3981	4775	5570
5	127	191	255	318	382	510	637	764	955	1145	1274	1592	1911	2228	2548	2866	3185	3820	4456
6	106	159	212	265	318	425	531	637	796	954	1062	1327	1592	1856	2123	2388	2654	3183	3714
8	80	119	159	199	239	318	398	478	597	716	796	995	1194	1392	1592	1791	1991	2387	2785
10	64	96	127	159	191	255	318	382	479	572	637	796	955	1114	1274	1433	1593	1910	2228
12	53	80	106	133	159	212	265	318	398	477	531	663	796	928	1062	1194	1327	1592	1857
14	45	68	91	114	136	182	227	273	341	409	455	569	682	795	910	1023	1138	1364	1592
16	40	60	80	100	119	159	199	239	299	358	398	498	597	696	796	895	996	1194	1399
18	35	53	71	88	106	142	170	212	265	318	354	442	531	618	708	796	885	1061	1238
20	32	48	64	80	96	127	159	191	239	286	318	398	478	557	637	716	797	955	1114
22	28	43	57	72	86	115	144	173	216	260	289	361	433	506	578	651	724	868	1013
24	26	39	52	66	79	106	132	159	198	238	265	331	397	464	530	597	664	796	928
27	23	35	47	58	70	94	117	141	176	211	235	294	353	412	471	531	590	707	825
30	21	32	42	53	64	85	106	127	159	190	212	265	318	371	425	478	531	637	743
33	19	28	38	48	57	77	96	115	144	173	192	240	289	337	385	434	483	579	675
36	17	26	35	43	52	70	88	105	132	159	176	220	265	309	353	398	443	531	619
39	16	24	32	40	48	65	81	97	122	146	162	204	244	285	326	367	409	490	571
42	15	22	30	37	45	60	75	90	113	136	151	189	227	265	303	341	380	455	531
45	14	21	28	35	42	57	71	85	106	127	142	177	212	247	283	318	354	424	495
48	13	19	26	33	39	52	66	79	99	119	132	165	198	232	265	299	332	398	464
52	12	18	24	30	36	48	61	73	91	110	122	152	183	214	244	276	307	367	428

Beispiel: V = 12 m/min bei Ø 8 mm → 478 r.p.m.

Umdrehungsvorgaben für Bi-Metall Lochsägen

Durchmesser	Weich-Stahl	VA-Stahl	Guss-Stahl	Messing	Alu-minium
14	550	300	400	790	900
16	530	275	365	730	825
17	500	250	330	665	750
19	460	230	300	600	690
21	425	210	280	560	630
22	390	195	260	520	585
24	370	185	245	495	555
25	350	175	235	470	525
27	325	160	215	435	480
29	300	150	200	400	450
30	285	145	190	380	425
32	275	140	180	360	410
33	260	135	175	345	390
35	250	125	165	330	375
37	240	120	160	315	360
38	230	115	150	300	345
40	220	110	145	290	330
41	210	105	140	280	315
43	205	100	135	270	305
44	195	95	130	260	295
46	190	95	125	250	285
48	180	90	120	240	270
51	170	85	115	230	255
52	165	80	110	220	245
54	160	80	105	210	240
57	150	75	100	200	230
59	145	75	100	195	225
60	140	70	95	190	220
64	135	70	90	180	205
65	130	65	85	175	200

Durchmesser	Weich-Stahl	VA-Stahl	Guss-Stahl	Messing	Alu-minium
67	130	65	85	170	195
70	125	60	80	160	185
73	120	60	80	160	180
76	115	55	75	150	170
79	110	55	70	145	165
83	105	50	70	140	155
86	100	50	65	130	150
89	95	45	65	125	145
92	95	45	60	120	140
95	90	45	60	120	135
98	90	45	60	115	130
102	85	40	55	115	125
105	85	40	55	110	120
108	80	40	55	110	115
111	80	40	50	100	110
114	75	35	50	100	105
121	70	35	45	90	95
127	65	30	40	85	90
140	60	30	35	80	85
146	55	25	35	75	80
152	55	25	35	75	80

Gebrauchsanweisung für Bi-Metall Lochsägen • Benutzen Sie die Lochsägen immer mit der vorgegebenen Drehzahl. Zu schnelles Sägen erwärmt die Säge und reduziert die Standzeit (Zahnausbruch/Abschleifen der Zähne) • Lochsäge nicht mit zu hohem Anpressdruck einsetzen • Zentrierbohrer schaut ca. 3 mm über die Zahnspitzen - jedoch nicht mehr als die Dicke des zu sägenden Materials • Ausreichend Schneidlöl benutzen (außer bei Guss-Stahl), damit wird die Standzeit verlängert und der Schnitt ist sauber • Lochsäge mit Aufnahmewerkzeug und Bohrmaschine fest verbinden • Lochsäge gerade auf Oberfläche des Materials halten, NIE winklig einsetzen • Zentrierbohrer fest im Aufnahmewerkzeug verschrauben, Aufnahmewerkzeug fest auf Lochsäge aufschrauben, Führungsstifte durch die Lochsägenkappe schrauben • Erst Lochsäge mit Aufnahmewerkzeug verbinden, dann Führungsstifte durch KAPpe schrauben • Immer Sicherheitsbrille tragen!

Anfrageformular Sonderanfertigungen

Wir gehen gerne auf Ihre speziellen Werkzeuganforderungen ein und produzieren auch Sonderanfertigungen nach Ihren Angaben. Nutzen Sie dafür bitte unser Anfrageformular.

Nach Prüfung aller technischen Anforderungen erstellen wir Ihnen ein individuelles Angebot.

Fax +49 (0) 2191.362 50 16

Absender / Firmenstempel

Anfrage Nr.

Datum

Wir benötigen folgende Angaben:

1. ZUM GEWINDE

1.1 Gewindeart _____ Abmessung _____ Toleranz _____
bzw.
Gewinde-Nenndurchmesser _____ Steigung _____ mm oder _____ Gang/1"

1.2 eingängig mehrgängig Steigung _____ mm oder _____ Gang/1"

1.3 Rechtsgewinde Linksgewinde

1.4 Gewindemaße der Mutter:

Außendurchmesser _____ mm min. _____ mm max. _____ mm

Flankendurchmesser _____ mm min. _____ mm max. _____ mm

Kerndurchmesser _____ mm min. _____ mm max. _____ mm

Flankenwinkel _____ °

Bei unsymmetrischem Gewindeprofil (z.B. Sägewinde) Profilform und Einschnitttrichtung angeben.

1.5 Einschnittgewindebohrer Satzgewindebohrer _____ Stück je Satz
_____ oder Maschinengewindebohrer

Menge _____ Stück / Satz

2. ZUM WERKSTÜCK

2.1 Durchgangsloch Sackloch

2.2 zu schneidende Gewindelänge: L1 _____ mm
bei Sackloch auch Bohrtiefe: L2 _____ mm

2.3 Gewinde bereits vorgeschritten ja nein

2.4 Material: _____ Werkstoff-Nr. _____

2.5 Schneidvorgang: senkrecht ohne zwangsläufigen Vorschub
 waagrecht mit zwangsläufigen Vorschub (Leitpatrone, bitte angeben)
 von Hand ohne Kühlmittel
 maschinell mit Kühlmittel (bitte angeben)

Sonstige Angaben: _____

EXACT

PRÄZISIONSWERKZEUGE



IHRE ENTSCHEIDUNG! YOUR DECISION!



Höchste Fertigungsqualität | Maximum production quality

Zertifizierung nach DIN ISO 9001 | Certified to DIN ISO 9001

Neueste Produktionstechnologien | Latest production technologies

Umfangreiche Produktauswahl | Wide range of products

Mehr Information? More information?
www.exact.info

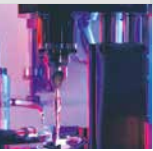

Für Ihre Notizen
For your notes

EXACT
PRÄZISIONSWERKZEUGE



Für Ihre Notizen
For your notes

EXACT
PRÄZISIONSWERKZEUGE

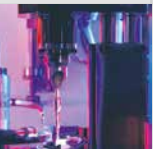

Für Ihre Notizen
For your notes

EXACT
PRÄZISIONSWERKZEUGE

Liefer- und Zahlungsbedingungen

Conditions of Sale and Delivery

Bestellhinweise

Bitte stets Code-Nummer angeben! Mindestbestellwert: 80,00 EUR (unter 80,00 EUR erheben wir eine Bearbeitungsgebühr von 15,00 EUR)!

Unsere Werkzeuge sind listenmäßig auf die Bearbeitung von Stahl mittlerer Festigkeit abgestimmt. Wenn andere Werkstoffe bearbeitet werden sollen, bitten wir um Mitteilung,

weil ggf. die Schnittwinkel, Anschrittlängen etc. der Werkzeuge geändert werden müssen. Bei Nichtbeachtung, bzw. ohne Angabe des Verwendungszweckes, lehnen wir im Falle einer Reklamation Ersatzleistung ab.

Schnittwinkeländerungen bedingen Aufpreise.

Allgemeine Geschäftsbedingungen

I. Angebot

Die zu dem Angebot gehörenden Unterlagen, wie Abbildungen, Zeichnungen, Gewichts- und Maßangaben, sind nur annähernd maßgebend, soweit sie nicht ausdrücklich als verbindlich bezeichnet sind. An Kostenanschlägen, Zeichnungen und anderen Unterlagen behält der Lieferer Eigentums- und Urheberrechte vor; sie dürfen Dritten nicht zugänglich gemacht werden. Der Lieferer ist verpflichtet, vom Besteller vertraulich bezeichnete Pläne nur mit dessen Zustimmung Dritten zugänglich zu machen. Der Besteller übernimmt für die von ihm beizubringenden Unterlagen, wie Zeichnungen, Lehren, Muster oder dgl., die alleinige Verantwortung. Der Besteller hat dafür einzustehen, dass von ihm vorgelegte Ausführungszeichnungen in Schutzrechte Dritter nicht eingreifen. Der Lieferer ist dem Besteller gegenüber nicht zur Prüfung verpflichtet, ob durch Abgabe von Angeboten aufgrund ihm eingesandter Ausführungszeichnungen im Falle der Ausführung irgendwelche Schutzrechte Dritter verletzt werden. Ergibt sich trotzdem eine Haftung des Lieferers, so hat der Besteller ihn schadlos zu halten. Das gilt nicht bei Vorsatz oder grober Fahrlässigkeit des Inhabers oder leitender Angestellter. Muster werden nur gegen Berechnung geliefert.

II. Umfang der Lieferung

Für den Umfang der Lieferung ist die schriftliche Auftragsbestätigung des Lieferers maßgebend, im Falle eines Angebots des Lieferers mit zeitlicher Bindung und fristgemäßer Annahme das Angebot, sofern keine rechtzeitige Auftragsbestätigung vorliegt. Nebenabreden und Änderungen bedürfen der schriftlichen Bestätigung des Lieferers. Werden Sonderwerkzeuge in Auftrag gegeben, so darf die Bestellmenge um ca. 10%, mind. jedoch um 2 Stück über- oder unterschritten werden. Berechnet wird die Liefermenge.

III. Preis und Zahlung

Die Preise gelten mangels besonderer Vereinbarung ab Werk einschließlich Verladung im Werk, jedoch ausschließlich Verpackung. Zu den Preisen kommt die Mehrwertsteuer in der jeweiligen gesetzlichen Höhe hinzu. Mangel besonderer Vereinbarung ist die Zahlung ohne jeden Abzug frei Zahlstelle des Lieferers innerhalb von 30 Tagen nach Rechnungsdatum (auch bei Teillieferungen) zu leisten. Die Zurückhaltung von Zahlungen oder die Aufrechnung wegen etwaiger vom Lieferer bestrittener Gegenansprüche des Bestellers sind nicht statthaft.

IV. Lieferzeit

Die Lieferfrist beginnt mit der Absendung der Auftragsbestätigung, jedoch nicht vor der Beibringung der vom Besteller zu beschaffenden Unterlagen, Genehmigungen, Freigaben sowie vor Eingang einer vereinbarten Anzahlung. Die Lieferfrist ist eingehalten, wenn bis zu ihrem Ablauf der Liefergegenstand das Werk verlassen hat oder die Versandbereitschaft mitgeteilt ist. Die Lieferfrist verlängert sich angemessen bei Maßnahmen im Rahmen von Arbeitskämpfen, insbesondere Streik und Aussperrung sowie beim Eintritt unvorhergesehener Hindernisse, die außerhalb des Willens des Lieferers liegen, soweit solche Hindernisse nachweislich auf die Fertigstellung oder Ablieferung des Liefergegenstandes von erheblichem Einfluß sind. Dies gilt auch, wenn die Umstände bei Unterlieferung eintreten. Die vorbeschriebenen Umstände sind auch dann vom Lieferer nicht zu vertreten, wenn sie während eines bereits vorliegenden Verzuges entstehen. Beginn und Ende derartiger Hindernisse wird in wichtigen Fällen der Lieferer dem Besteller baldmöglichst mitteilen. Wird der Versand auf Wunsch des Bestellers verzögert, so ist der Lieferer berechtigt, nach Setzung und fruchtlosem Ablauf einer angemessenen Frist, anderweitig über den Liefergegenstand zu verfügen und den Besteller mit angemessener verlängerter Frist zu beliefern. Die Einhaltung der Lieferfrist setzt die Erfüllung der Vertragspflichten des Bestellers voraus.

V. Gefahrübergang und Entgegennahme

Die Gefahr geht spätestens mit der Absendung der Lieferteile auf den Besteller über, und zwar auch dann, wenn Teillieferungen erfolgen oder der Lieferer noch andere Leistungen, z.B. die Versandkostenkosten oder Anfuhr und Aufstellung übernommen hat. Auf Wunsch des Bestellers wird auf seine Kosten die Sendung durch den Lieferer gegen Diebstahl, Bruch-, Transport-, Feuer- und Wasserschäden sowie sonstig versicherbare Risiken ver-

sichert. Verzögert sich der Versand infolge von Umständen, die der Besteller zu vertreten hat, so geht die Gefahr vom Tage der Versandbereitschaft auf den Besteller über; jedoch ist der Lieferer verpflichtet, auf Wunsch und Kosten des Bestellers die Versicherungen zu bewirken, die dieser verlangt. Ausgelieferte Gegenstände sind, auch wenn sie unwesentliche Mängel aufweisen, vom Besteller unbeschadet der Rechte aus Abschnitt VII entgegenzunehmen. Teillieferungen sind zulässig.

VI. Eigentumsvorbehalt

Der Lieferer behält sich das Eigentum an dem Liefergegenstand vor, bis sämtliche Forderungen des Lieferers gegen den Besteller aus der Geschäftsverbindung einschließlich der künftig entstehenden Forderungen auch als gleichzeitig oder später abgeschlossenen Verträgen beglichen sind. Dies gilt auch dann, wenn einzelne oder sämtliche Forderungen des Lieferers in eine laufende Rechnung aufgenommen wurden und der Saldo gezogen und anerkannt ist. Bei vertragswidrigem Verhalten des Bestellers, insbesondere bei Zahlungsverzug, ist der Lieferer zur Rücknahme des Liefergegenstandes nach Mahnung berechtigt und der Besteller zur Herausgabe verpflichtet. In der Rücknahme sowie in der Pfändung des Gegenstandes durch den Lieferer liegt ein Rücktritt vom Vertrag nur dann vor, wenn dies der Lieferer ausdrücklich schriftlich erklärt hat. Bei Pfändungen oder sonstigen Eingriffen Dritter hat der Besteller den Lieferer unverzüglich schriftlich zu benachrichtigen.

Der Besteller ist berechtigt, den Liefergegenstand im ordentlichen Geschäftsgang weiterzuverkaufen. Er tritt jedoch dem Lieferer bereits jetzt alle Forderungen mit sämtlichen Nebenrechten ab, die ihm aus der Weiterveräußerung gegen den Abnehmer oder gegen Dritte erwachsen. Zur Einziehung dieser Forderungen ist der Besteller auch nach der Abtretung ermächtigt, so lange er sich vertragstreu verhält und keine Zahlungsunfähigkeit vorliegt. Die Befugnis des Lieferers, die Forderungen selbst einzuziehen, bleibt hiervon unberührt; jedoch verpflichtet sich der Lieferer, die Forderungen nicht einzuziehen, solange der Besteller seinen Zahlungsverpflichtungen ordnungsgemäß nachkommt und keine Zahlungsunfähigkeit vorliegt. Der Lieferer kann sonst verlangen, daß der Besteller ihm die abgetretenen Forderungen und deren Schuldner bekannt gibt, alle zum Einzug erforderlichen Angaben macht, die dazugehörigen Unterlagen aushändigt und den Schuldner der Abtretung mitteilt. Wird der Liefergegenstand zusammen mit anderen Waren, die dem Lieferer nicht gehören, weiterverkauft, so gilt die Forderung des Bestellers gegen den Abnehmer in Höhe des zwischen Lieferer und Besteller vereinbarten Lieferpreises als abgetreten. Wenn die Sicherheiten des Lieferers den realisierbaren Wert der Forderungen um 20% übersteigen, muss der Lieferer die übersteigenden Forderungen freigeben.

Der Lieferer ist berechtigt, den Liefergegenstand auf Kosten des Bestellers gegen Diebstahl, Bruch-, Feuer-, Wasser- und sonstige Schäden zu versichern, sofern nicht der Besteller selbst die Versicherung nachweislich abgeschlossen hat.

Der Besteller darf den Liefergegenstand weder verpfänden noch zur Sicherung übereignen. Bei Pfändungen sowie Beschlagnahme oder sonstigen Verfügungen durch Dritte hat er den Lieferer unverzüglich davon zu benachrichtigen.

Wird im Zusammenhang mit der Bezahlung des Kaufpreises durch den Besteller eine wechselseitige Haftung des Lieferers begründet, so erlöschen der Eigentumsvorbehalt, einschließlich seiner vereinbarten Sonderformen, oder sonstige zur Zahlungsverpflichtung vereinbarte Sicherheiten nicht vor Erlösung des Wechsels durch den Besteller als Bezogenem.

VII. Haftung für Mängel der Lieferung

Für Mängel der Lieferung, zu denen auch das Fehlen ausdrücklich zugesicherter Eigenschaften gehört, haftet der Lieferer unter Ausschluss weiterer Ansprüche unbeschadet Abschnitt IX 4., wie folgt: Alle diejenigen Teile sind unentgeltlich nach billigem Ermessen unterliegender Wahl des Lieferers nachzubessern oder neu zu liefern, die sich innerhalb von 6 Monaten seit Lieferung infolge eines von dem Gefahrübergang liegenden Umstandes – insbesondere mit fehlerhafter Bauart, schlechter Baustoffe oder mangelhafter Ausführung – als unbrauchbar oder in ihrer Brauchbarkeit nicht unerheblich beeinträchtigt herausstellen. Die Feststellung solcher Mängel ist

dem Lieferer unverzüglich schriftlich zu melden. Ersetzte Teile werden Eigentum des Lieferers. Für Mängel des vom Besteller angelieferten Materials haftet der Lieferer nur, wenn er bei Anwendung fachmännischer Sorgfalt die Mängel hätte erkennen müssen. Verzögert sich der Versand, ohne Verschulden des Lieferers, so erlischt die Haftung spätestens 12 Monate nach Gefahrenübergang. Für wesentliche Fremderzeugnisse beschränkt sich die Haftung des Lieferers auf die Abtretung der Haftansprüche, die ihm gegen den Lieferer des Fremderzeugnisses zustehen. Bei Fertigung nach Zeichnung des Bestellers haftet der Lieferer nur für die zeichnungsmäßige Ausführung.

Das Recht des Bestellers, Ansprüche aus Mängeln geltend zu machen, verjährt in allen Fällen vom Zeitpunkt der rechtzeitigen Rüge an, in 6 Monaten, frühestens jedoch mit Ablauf der Gewährleistungsfrist.

Es wird keine Gewähr übernommen für Schäden, die aus nachfolgenden Gründen entstanden sind: Ungeeignete oder unsachgemäße Verwendung, fehlerhafte Montage bzw. Inbetriebsetzung durch den Besteller oder Dritte, natürliche Abnutzung, fehlerhafte oder nachlässige Behandlung, ungeeignete Betriebsmittel, chemische, elektrochemische oder elektrische Einflüsse, sofern sie nicht auf ein Verschulden des Lieferers zurückzuführen sind. Zur Vornahme aller dem Lieferer nach billigem Ermessen notwendig erscheinenden Nachbesserungen und Ersatzlieferungen hat der Besteller nach Verständigung mit dem Lieferer die erforderliche Zeit und Gelegenheit zu geben, sonst ist der Lieferer von der Mängelhaftung befreit. Nur in dringenden Fällen der Gefährdung der Betriebssicherheit und zur Abwehr unverhältnismäßig großer Schäden, wobei der Lieferer sofort zu verständigen ist, oder wenn der Lieferer mit der Beseitigung des Mangels im Verzug ist, hat der Besteller das Recht, den Mangel selbst oder durch Dritte beseitigen zu lassen und vom Lieferer Ersatz der notwendigen Kosten zu verlangen. Von den durch die Nachbesserung bzw. Ersatzlieferung entstehenden unmittelbaren Kosten trägt der Lieferer – insoweit als sich die Beanstandung als berechtigt herausstellt – die Kosten des Ersatzstückes, einschließlich des Versandes. Im übrigen trägt der Besteller die Kosten.

Für das Ersatzstück und die Nachbesserung beträgt die Gewährleistungsfrist 3 Monate, sie läuft mindestens aber bis zum Ablauf der ursprünglichen Gewährleistungsfrist für den Liefergegenstand. Durch etwa seitens des Bestellers oder Dritter unsachgemäß, ohne vorherige Genehmigung des Lieferers, vorgenommene Änderungen oder Instandsetzungsarbeiten wird die Haftung für die daraus entstehenden Folgen aufgehoben. Weitere Ansprüche des Bestellers, insbesondere ein Anspruch auf Ersatz von Schäden, die nicht an dem Liefergegenstand selbst entstanden sind, sind ausgeschlossen. Dieser Haftungsausschluss gilt nicht bei Vorsatz, bei grober Fahrlässigkeit des Inhabers oder leitender Angestellter sowie bei schuldhafter Verletzung wesentlicher Vertragspflichten. Bei schuldhafter Verletzung wesentlicher Vertragspflichten haftet der Lieferer – außer in den Fällen des Vorsatzes und der groben Fahrlässigkeit des Inhabers und leitender Angestellter – nur für den vertragstypischen, vernünftigerweise vorhersehbaren Schaden. Der Haftungsausschluss gilt ferner nicht in den Fällen, in denen nach Produkthaftungsgesetz bei Fehlern des Liefergegenstandes für Personen- oder Sachschäden an privat genutzten Gegenständen gehaftet wird. Er gilt auch nicht beim Fehlen von Eigenschaften, die ausdrücklich zugesichert sind, wenn die Zusage gerade bezweckt hat, den Besteller gegen Schäden, die nicht am Liefergegenstand selbst entstanden sind, abzusichern.

VIII. Haftung für Nebenpflichten

Wenn durch Verschulden des Lieferers der gelieferte Gegenstand vom Besteller infolge unterlassener oder fehlerhafter Ausführung von vor oder nach Vertragsschluss liegenden Vorschlägen und Beratungen sowie anderen vertraglichen Nebenverpflichtungen – insbesondere Anleitung für Bedienung und Wartung des Liefergegenstandes – nicht vertragsgemäß verwendet werden kann, so gelten unter Ausschluss weiterer Ansprüche des Bestellers die Regelungen der Abschnitte VII und IX entsprechend.

IX. Recht des Bestellers auf Rücktritt, Wandelung und sonstige Haftung des Lieferers

Der Besteller kann vom Vertrag zurücktreten, wenn

dem Lieferer die gesamte Leistung vor Gefahrenübergang endgültig unmöglich wird. Dasselbe gilt bei Unvermögen des Lieferers. Der Besteller kann auch dann vom Vertrag zurücktreten, wenn bei einer Bestellung gleichartiger Gegenstände die Ausführung eines Teils der Lieferung der Anzahl nach unmöglich wird und er ein berechtigtes Interesse an der Ablehnung einer Teillieferung hat; ist dies nicht der Fall, so kann der Besteller die Gegenleistung entsprechend mindern.

Liegt Leistungsverzug im Sinne des Abschnittes IV der Lieferbedingung vor und gewährt der Besteller dem in Verzug befindlichen Lieferer eine angemessene Nachfrist mit der ausdrücklichen Erklärung, dass er nach Ablauf dieser Frist die Annahme der Leistung ablehne, und wird die Nachfrist nicht eingehalten, ist der Besteller zum Rücktritt berechtigt. Tritt die Unmöglichkeit während des Annahmeverzuges oder durch Verschulden des Bestellers ein, so bleibt dieser zur Gegenleistung verpflichtet. Der Besteller hat ferner ein Recht zur Rückgängigmachung des Vertrages, wenn der Lieferer eine ihm gestellte angemessene Nachfrist für die Ausbesserung oder Ersatzlieferung bezüglich eines von ihm zu vertretenden Mangels im Sinne der Lieferbedingungen durch sein Verschulden fruchtlos verstreichen lässt. Das Recht des Bestellers auf Rückgängigmachung des Vertrages besteht auch in sonstigen Fällen des Fehlschlagens der Ausbesserung oder Ersatzlieferung durch den Lieferer. Ausgeschlossen sind alle anderen weitergehenden Ansprüche des Bestellers, insbesondere auf Kündigung oder Minderung sowie auf Ersatz von Schäden irgendwelcher Art, und zwar auch von solchen Schäden, die nicht an dem Liefergegenstand selbst entstanden sind. Dieser Haftungsausschluss gilt nicht bei Vorsatz, bei grober Fahrlässigkeit des Inhabers oder leitender Angestellter sowie bei schuldhafter Verletzung wesentlicher Vertragspflichten. Bei schuldhafter Verletzung wesentlicher Vertragspflichten haftet der Lieferer – außer in den Fällen des Vorsatzes und der groben Fahrlässigkeit des Inhabers und leitender Angestellter – nur für den vertragstypischen, vernünftigerweise vorhersehbaren Schaden. Der Haftungsausschluss gilt ferner nicht in den Fällen, in denen nach Produkthaftungsgesetz bei Fehlern des Liefergegenstandes für Personen- oder Sachschäden an privat genutzten Gegenständen gehaftet wird. Er gilt auch nicht beim Fehlen von Eigenschaften, die ausdrücklich zugesichert sind, wenn die Zusage gerade bezweckt hat, den Besteller gegen Schäden, die nicht am Liefergegenstand selbst entstanden sind, abzusichern.

X. Besondere Bedingungen für Bearbeitungsverträge (Fertigung, Auarbeitung, Umarbeitung oder Wiederherstellung von Werkzeugen)

Ergänzend zu oder abweichend von den Lieferbedingungen für derartige Bearbeitungsverträge: Die Rechnungen sind sofort ohne Abzug zu bezahlen. Für das Verhalten des an den Bearbeiter eingesandten Materials übernimmt dieser keine Haftung. Sein Anspruch auf Vergütung bleibt unberührt. Wird das Material bei der Bearbeitung durch Verschulden des Bearbeiters unbrauchbar, entfallen der Vergütungsanspruch des Bearbeiters und ein etwaiger Schadensersatzanspruch des Bestellers. Dieser Haftungsausschluss gilt nicht bei Vorsatz oder grober Fahrlässigkeit des Inhabers oder leitender Angestellter und in den Fällen, in denen nach Produkthaftungsgesetz bei Fehlern des Liefergegenstandes für Personen- oder Sachschäden an privat genutzten Gegenständen gehaftet wird.

XI. Sonstige Haftung

Soweit eine Haftung des Lieferers, gleichgültig aus welchem Rechtsgrund, gegeben ist, beschränkt sich diese auf höchstens 5 % vom Wert der betroffenen Liefermenge. Diese Haftungsbegrenzung gilt nicht bei Vorsatz oder grober Fahrlässigkeit des Inhabers oder leitender Angestellter und in den Fällen, in denen nach Produkthaftungsgesetz bei Fehlern des Liefergegenstandes für Personen- oder Sachschäden an privat genutzten Gegenständen gehaftet wird.

XII. Gerichtsstand

Bei allen sich aus dem Vertragsverhältnis ergebenden Streitigkeiten ist, wenn der Besteller Vollkaufmann, eine juristische Person des öffentlichen Rechts oder ein öffentlich-rechtliches Sondervermögen ist, die Klage bei dem Gericht zu erheben, das für die Hauptsitz oder für die Lieferung ausführende Zweigiederlassung des Lieferers zuständig ist. Der Lieferer ist auch berechtigt, am Hauptsitz des Bestellers zu klagen.



EXACT

GmbH & Co. KG Präzisionswerkzeuge
Am Eichholz 19
D-42897 Remscheid
Germany

Tel.: + 49 (0) 2191.36250-0
Fax: + 49 (0) 2191.36250-16

info@exact.info



www.exact.info

Version 1.5