

Catalog 2019 / 2020



WWW.BGSTechnic.com

QUICKFINDER SINGLE SIZES

QF Quick-Finder

Sockets	QF1-5
Bit Sockets	QF6-8
Bits	QF9
Adaptors / Extensions / T-Bars / Flexible Handles	QF10
Spanners	QF11-13

HAND TOOLS

1

Workshop Trolleys	4
Socket Sets & Tool Assortments	73
Sockets	114
Bit Sockets & Bits	151
Ratchets, Extensions, Adaptors & Accessories	183
Torque Tools	202
Hand Tools	209
Pneumatic Tools	386
Electric / Cordless Battery Tools	426

AUTOMOTIVE TOOLS

435

Speciality Tools Motorbike	436
Speciality Tools SUV and Trucks	456
Speciality Tools Car	464
Workshop Equipment	464
Car Accessories	895

MISCELLANEOUS TOOLS & SMALL PARTS

899

Industrial Safety	900
Industrial Chemicals	905
House & Garden	913
Sales Aids	916
Alphabetical Index	923
Numerical Index	940



Head Office

BGS technic's headquarter is located in Wermelskirchen, next to the A1 highway exit. Modern offices, large-scale storage capacity, spacious show rooms and a fully equipped repair shop cover an area of 15,000 m². Supported by modern electronic data processing equipment, we are ready for future expansion and look forward to working with you.

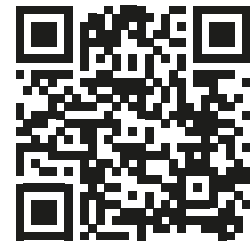

Warehouse

Sophisticated planning and a steady flow of goods management enable us to handle large amounts of merchandise. Cutting-edge process optimization, extensive storage facilities with modern highrise racks allow perfect order processing and a 24 hour delivery service.





Tradeshows

Continuous participation in international fairs create a basis for personal customer contact.



automechanika
FRANKFURT

AutoZum[®]
Salzburg

EQUIP AUTO



Repair Shop

Our professional repair shop has many options of maintaining and repairing BGS tools. Quality control and materials testing in cooperation with well-known testing institutes are the basis for optimal quality assurance.





BGS technic® - a brand for perfect tools!

Since the early 1970, the BGS technic brand is a symbol of fine quality tools and constant innovation every year, in over 90 countries worldwide. The BGS technic brand stands for high quality, long lasting hand tools and air tools for daily workshop use. Our overall aim is to offer fast service, a comprehensive product range and product innovations at the very best value for money for the benefit of our customers. More than 6000 quality tools are supplied directly from our modern distribution center, and come in an appealing and self explanatory sales packaging in German and English language.



Items marked with this icon are supplied in a „ready-to-be-sold“ packaging afor hanging.

Icon for drive sizes in e.g. sockets

6.3^m  **1/4"**
(compatible to 1/4")

10^m  **3/8"**
(compatible to 3/8")

12.5^m  **1/2"**
(compatible to 1/2")

20^m  **3/4"**
(compatible to 3/4")

25^m  **1"**
(compatible to 1")

1/4" 3/8" 1/2"  Tools in inch sizes.



Pro Torque®
for better screw protection avoids rounding of the screw edges.



Super Lock
for added torque. Extends life of the socket and the screw.



Gear Lock
profile provides universal use for hexagon, 12-point, T-Star (E-type), metric and inch screws.



12-point
for problem-free high torque use on 12-point screw heads

Material Symbols



Chrome Molybdenum Steel



Chrome Vanadium Steel



Chrome Vanadium S2 Steel

BGS technic® Sales Stands

BGS offers sales stands perfectly adapted to your customer's needs, including all necessary accessories. Contact us for further information regarding the available stands and ask us for individually planned sales stands.





BGS technic® Sponsoring

BGS campaigns for the promotion of children and youth sports for years already, and also supports motorsports. In cooperation with various motorsport teams, our tools constantly undergo tough tests in racing practice in different racing leagues worldwide.



BGS technic® Product Videos

We constantly upload new product videos and tutorials, have a look at <http://youtube.bgstechnic.com>

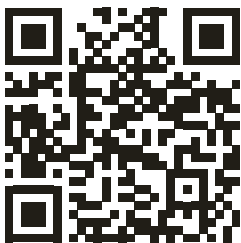

Sockets Hexagon Pro Torque®

mm	6.3mm □ 1/4"		10mm □ 3/8"		12.5mm □ 1/2"		20mm □ 3/4"	25mm □ 1"
	short	deep	short	deep	short	deep	short	short
3,5	2473							
4	2474	10504						
4,5	2475							
5	2476	10505						
5,5	2477	10503						
6	2478	10506						
7	2479	10507						
8	2480	10508		10528	2908	9355		
9	2481	10509			2909			
10	2482	10510	10610	10530	2910	10550		
11	2483	10511	10611	10531	2911	10551		
12	2484	10512	10612	10532	2912	10552		
13	2485	10513	10613	10533	2913	10553		
14	2486	10514	10614	10534	2914	10554		
15			10615	10535	2915	10555		
16			10616	10536	2916	10556		
17			10617	10537	2917	10557		
18			10618	10538	2918	10558		
19			10619	10539	2919	10559	3419	
20					2920	10560		
21					2921	10561	3421	
22					2922	10562	3422	
23							3423	
24					2924	10564	3424	
26					2926	10566	3426	
27			10627		2927	10567	3427	
28					2928	10568		
30					2930	10570	3430	
32					2932	10572	3432	
33							3433	
34					2934		3434	
35					2935		3435	
36					2936		3436	3736
38							3438	
41							3441	3741
42							3442	
44							3444	
46							3446	3746
48							3448	
50							3450	3750
55							3455	3755
60							1207-60	3760
65								3765
70								3770
75								3775
80								3780



Quick-Finder

Sockets

Quick-Finder

Sockets Hexagon Pro Torque® | Inch sizes

Inch	6.3mm □ 1/4"		12.5mm □ 1/2"	Inch	12.5mm □ 1/2"
	short	deep	short		short
5/32"	10650			1"	2787
3/16"	10651			1.1/16"	2784
7/32"	10652			1.1/8"	2788
1/4"	10653	10670		1.1/4"	2786
9/32"	10654				
5/16"	10655	10671			
11/32"	10656				
3/8"	10657	10672	2770		
7/16"	10658	10673	2771		
1/2"	10659	10674	2772		
9/16"			2773		
5/8"			2774		
11/16"			2775		
3/4"			2776		
13/16"			2777		
7/8"			2778		
15/16"			2779		

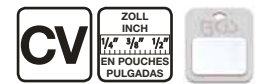





QF1

Sockets 12-point

QF Quick-Finder



Sockets

QF Quick-Finder

 mm	 short	 short	 deep	 short
4	10774			
4,5	10773			
5	10775			
5,5	10772			
6	10776			
7	10777			
8	10778	10628	9356	
9	10779	10629		
10	10780	10630	10680	
11	10781	10631	9357	
12	10782	10632	10662	
13	10783	10633	10681	
14	10784	10634	10664	
15		10635	10682	
16		10636	10683	
17		10637	10684	
18		10638	10685	
19		10639	10686	7419
20		10640	9359	
21		10641	9360	7421
22		10642	10687	7422
24		10644	10688	7424
26		10626	10663	
27		10645	9363	7427
28		10625	10689	
30		10646		7430
32		10647		7432
34		10648		7434
36		10649		7436
38				7438
41				7441
46				7446
50				7450
55				7455



Sockets 12-point | Inch sizes

 mm	 short
5/32"	10870
3/16"	10871
7/32"	10872
1/4"	10873
9/32"	10874
5/16"	10875
11/32"	10876
3/8"	10877
7/16"	10878
15/32"	10879
1/2"	10880
9/16"	10881



Sockets Super Lock

mm	6.3 _m □ 1/4"		10 _m □ 3/8"		12.5 _m □ 1/2"	
	short	deep	short	deep	short	deep
4	2344	2964				
4,5	2339					
5	2345	2965				
5,5	2343					
6	2346	2966	2366			
7	2347	2967	2367			
8	2348	2968	2368	2610	2408	10268
9	2349	2969	2369	2611	2409	
10	2350	2970	2370	2600	2410	10270
11	2351	2971	2371	2601	2411	10271
12	2352	2972	2372	2602	2412	10272
13	2353	2973	2373	2603	2413	2943
14	2354	2974	2374	2604	2414	2944
15			2375	2605	2415	2945
16			2376	2606	2416	2946
17			2377	2607	2417	2947
18			2378	2608	2418	2948
19			2379	2609	2419	2949
20			2380		2420	9358
21			2381		2421	2951
22			2382		2422	2952
24			2384		2424	9361
27					2427	9362
28					2428	2956
30					2430	
32					2432	



Quick-Finder

Sockets

Quick-Finder

Sockets Gear Lock

mm	6.3 _m □ 1/4"		10 _m □ 3/8"		12.5 _m □ 1/2"	
	short	deep	short	deep	short	deep
4	10104	10154				
4,5	10101					
5	10105	10155				
5,5	10102					
6	10106	10156				
7	10107	10157				
8	10108	10158			10208	
9	10109	10159			10209	
10	10110	10160	10310	10350	10210	
11	10111	10161	10311	10351	10211	
12	10112	10162	10312	10352	10212	
13	10113	10163	10313	10353	10213	
14	10114		10314	10354	10214	10254
15			10315	10355	10215	10255
16			10316		10216	10256
17			10317		10217	10257
18			10318		10218	10258
19			10319		10219	10259
20					10220	
21					10221	
22					10222	
24					10224	
27					10227	
30					10230	
32					10232	



Sockets E-Type

mm	6.3 ^m □ 1/4"		10 ^m □ 3/8"		12.5 ^m □ 1/2"	
	short	short	short	short	deep	deep
E4	6404	2710				
E5	6405	2711				
E6	6406	2712				
E7	6407	2713				
E8	6408	2714				
E10	6430	6410	6460		6440	
E11	6431	6411	6461			
E12		6412	6462		6442	
E14		6414	6464		6444	
E16		6416	6466		6446	
E18		6417	6418		6448	
E20		2715	6420		6450	
E22			6422			
E24			6424			



Impact Sockets Pro Torque®, hexagon

mm	12.5 ^m □ 1/2"		20 ^m □ 3/4"		25 ^m □ 1"	
	short	deep	short	deep	short	deep
8	5205-8	7248				
10	5210	7210				
11	5211	7211				
12	5212	7212				
13	5213	7213				
14	5214	7214				
15	5215	7215				
16	5216	7216				
17	5217	7217	5617	5717		5500-17
18	5218	7218	5618	5718		
19	5219	7219	5619	5719		5500-19
21	5221	7221	5621	5721		5500-21
22	5222	7222	5622	5722		5500-22
24	5224	7224	5624	5724		5500-24
26			5626	5726		
27	5227	7227	5627	5727	5827	5500-27
30	5230	7230	5630	5730	5830	5500-30
32	5232	7232	5632	5732	5832	5500-32
33	5205-33		5633	5733	5833	5500-33
34	5205-34		5634	5734	5834	5500-34
35			5635		5835	
36	5205-36	7236	5636	5736	5836	5500-36
38	5205-38		5638	5738	5838	5500-38
39					5839	
40			5640			
41	5233		5641	5741	5841	5500-41
46			5646	5746	5846	5500-46
48			5648			
50			5650	5750	5850	5500-50
55			5655	5755	5855	5500-55
56					5856	
60			5660	5760	5860	5500-60
65					5865	5500-65
70					5870	5500-70
75					5875	5500-75
80					5880	5500-80
85					5885	5500-85
90					5890	5500-90
95					5895	5500-95
100						5500-100
105					5905	5500-105
110					5910	5500-110
115					5915	5500-115
120					5920	



Impact Sockets 12-point

mm	12.5mm \square 1/2"		20mm \square 3/4"
	short	deep	deep
17		5345	5345
19		5346	5346
21		5353	
24		5343	
27		5336	
28		5352	
30		5337	
32		5338	
33		5339	
34		5340	
35		5341	
36		5342	
38		5344	
39		5351	
46	5234		



Impact Sockets E-Type

mm	12.5mm \square 1/2"		20mm \square 3/4"
	short	deep	deep
E4			
E5			
E6			
E7			
E8			
E10	9779-10	5204-10	
E11		5204-11	
E12	9779-12	5204-12	
E14	9779-14	5204-14	
E16	9779-16	5204-16	
E18	9779-18	5204-18	5347
E20	9779-20	5204-20	5348
E22	9779-22	5204-22	
E24	9779-24	5204-24	5349
E26			5250-E26
E28			5250-E28
E30			5250-E30
E32			5250-E32



Special Socket / Screw Extractor

mm	10mm \square 3/8"	12.5mm \square 1/2"	12.5mm \square 1/2"
	short	short	deep
8		5269-8	
10	5270	5266-10	
11	5271	5266-11	
12	5272	5266-12	
13	5273	5266-13	
14	5274	5266-14	
15	5275	5266-15	
16	5276	5266-16	
17	5277	5266-17	5264-17
18	5278		
19	5279	5266-19	5264-19
21		5269-21	5264-21
22		5268-22	5264-22
24		5268-24	
27		5268-27	
32		5268-32	
36		5268-36	
41		5268-41	



Quick-Finder

Special Socket / Screw Extractor

Quick-Finder

Bit Sockets

	CV	CV-S2	6.3 _m □ 1/4"	10 _m □ 3/8"	12.5 _m □ 1/2"	20 _m □ 3/4"							
	25 mm	38 mm	300 mm	48 mm	55 mm	70 mm	100 mm	140 mm	160 mm	200 mm	240 mm	800 mm	85 mm
Inch	3/32"	2740											
	1/8"	2741		2720									
	5/32"	2742		2721									
	3/16"	2743		2722									
	7/32"	2744		2723									
	1/4"	2745		2725									
	9/32"	2746		2730									
	5/16"	2747		2727									
	3/8"	2748		2729									
	Metric	1,5 mm	5152										
2 mm		5153											
2,5 mm		5154											
3 mm		2497		2576									
3,5 mm		5155											
4 mm		2498		2577	4250		4259						
5 mm		2499		2578	4251		4260	4270		4275	4215		
5,5 mm		9466			9467								
6 mm		2500		2579	4252		4261	4271		4276	4216		
7 mm		2501		2580	4253		4262	4217		4277	5184-H7		
8 mm		2502		2581	4254		4263	4272		4278	4218		
9 mm				2583	4340		4268						
10 mm		2161-10		2582	4255		4264	5184-H10		4279			
11 mm							4266	5184-H11					
12 mm		2161-12		2584	4256		4265	4273		4280			
13 mm							4267	5184-H13					
14 mm						4257	5052-14	4296	4274				5189-H14
16 mm							5052-16						
17 mm						5184-H17	5052-17						5189-H17
18 mm							5052-18						
19 mm						5184-H19	5052-19						5189-H19
22 mm						5184-H22	4295						5189-H22
24 mm						5184-H24							
Internal hexagon with ball head		3 mm			5110								
	4 mm		9833	5111									
	5 mm			5112				4258-5	5184-HB5				
	5,5 mm			5113									
	6 mm			5114				4258-6					
	7 mm							4258-7					
	8 mm			5115				4258-8					
	10 mm							4258-10					
12 mm							4258-12						
Splines (for XZN)	M4	5105-M4											
	M5	5105-M5		4350		4359	4330		9350				
	M6	5105-M6		4351		4360	4331		9351				
	M7			4355			4432						
	M8	2503		5105-M8	4352	4361	4332		4334		4227		
	M9				4349		5184-M9	4333		9352			
	M10	2506			4353		4362	5109 5184-M10		4335		4228	
	M12	2507		2587	4354		4363	5184-M12		4336		4229	
	M14				4344		4364	5184-M14		4337		4233	
	M16				4346								
Splines Tamperproof (for XZN)	M17			5180-M17									
	M18			4347									
TS-Star Tamper-proof (for Torx)	M16			4356		4357							
	M18					4365							
	TS 10	5184-TS10											
	TS 15	2355-TS15 5184-TS15											
	TS 20	2355-TS20 5184-TS20											
	TS 25	2355-TS25 5184-TS25											
	TS 27	2355-TS27 5184-TS27											
	TS 30	2355-TS30 5184-TS30											
TS 40	2355-TS40 5184-TS40												
TS 45	5184-TS45												
TS 50	2355-TS50 5184-TS50												

Bit Sockets

	CV	CV-S2	6.3 ^m 1/4"	10 ^m 3/8"	12.5 ^m 1/2"	20 ^m 3/4"	110 mm									
	38 mm	75 mm	100 mm	400 mm	48 mm	100 mm	55 mm	100 mm	120 mm	140 mm	200 mm	240 mm	300mm	80 mm		
Plain Slot	4,0 mm	2493														
	5,5 mm	2494				2567										
	6,5 mm	2495														
	7,0 mm	2496				2568										
PH	PH#0	2504														
	PH#1	2487				2553										
	PH#2	2488				2554										
	PH#3	2489				2556										
PZ	PZ#0	2505														
	PZ#1	2490				2550										
	PZ#2	2491				2551										
	PZ#3	2492				2552										
T-Star (for Torx)	T7	2557														
	T8	2589														
	T9	2588														
	T10	2590				2760										
	T15	2591				2541	4368	4468								
	T20	2592				2542	4369	4469								
	T25	2593				2543	4370	4470	9364	9365						
	T27	2594				2544	4367	4467		9349						
	T30	2595		4202	2545	4371	4471	5184-T30	4479							
	T35	2565	2565-75			9627	9628									
	T40	2596			2546	4372	4472	5184-T40	4480							
	T45	2164-T45			2547	4373	4473	5184-T45	4481							
	T50	2164-T50			2548	4374	4474	5184-T50	4482							
	T55				2549	4375	4475	5184-T55	4483							
	T60				2761	4378	4476	5184-T60	4484					5189-T60		
T70					4379	4477	5003	5184-T70	4485				5189-T70			
T80													5189-T80			
T90													5189-T90			
T100													5189-T100			
T-Star Tamper-proof (for Torx)	T8	2356														
	T9	2364														
	T10	2357														
	T15	2358														
	T20	2359				2571										
	T25	2360				2572				9365						
	T27	2361				2573			9348	9349						
	T30	2362		4203	2574								5184-TB30			
	T40	2363			2575	4326										
	T45	2165-T45			2597	4327										
	T50	2165-T50				4328										
	T55				2599	4329										
	T60					4376										
	T70					4377		5103-TB70								
	T80						5184-TB80	5103-TB80								
T90							5103-TB90									
T100							5103-TB100									
Splines (for Ribe)	M5					4150	4160									
	M6					4141	4151	4161								
	M7					4142	4152	4162		4234		5184-R7				
	M8					4143	4153	4163		4173	4183	5184-R8				
	M9					4154	5184-R9			4174	4184					
	M10.3					9353	9354			4179	4185					
	M10				4145	4155	4165		5184-R10	4189						
	M12					4156	4166	5010	4176	4186						
M13					4157	4167	5007	4177	4187							
M14					4158	4168		4178	4188							

Quick-Finder

Bit Sockets

Quick-Finder

Bit Socket | T-Star for VAG polyDrive cylinder head bolts

CV  **12.5mm 1/2"**
168 mm

 **T52** 9386

polyDrive













QF Quick-Finder













Impact Bit Sockets

QF Quick-Finder

Impact Bit Sockets

			12.5mm 1/2"			20mm 3/4"	CV	CRO MO	BCS
	42 mm	55 mm	75 mm	100 mm	140 mm	55 mm			
 T-Star (for Torx)	T20	5486-T20	5369	5480-T20	5469				
	T25	5486-T25	5370	5480-T25	5470				
	T27	5486-T27	5367		5467				
	T30	5486-T30	5371	5480-T30	5471				
	T40	5486-T40	5372	5480-T40	5472				
	T45	5486-T45	5373	5480-T45	5473				
	T47		5378						
	T50	5486-T50	5374	5480-T50	5474				
	T55	5486-T55	5375	5480-T55	5475				
	T60	5486-T60		5480-T60					
 Internal hexagon	5 mm	5485-5		5481-M5					
	6 mm	5485-6		5481-M6	4286				
	7 mm	5485-7		5481-M7					
	8 mm	5485-8		5481-M8					
	9 mm	5485-9							
	10 mm	5485-10		5481-M10					
	11 mm	5485-11							
	12 mm	5485-12		5481-M12		5054-12			
	13 mm	5485-13							
	14 mm	5485-14		5481-M14		5054-14			
 Splined (for XZN)	M 4	5487-M4		5482-M4					
	M 5	5487-M5		5482-M5					
	M 6	5487-M6		5482-M6					
	M 8	5487-M8		5482-M8	4358				
	M 9			5482-M9					
	M 10	5487-M10		5482-M10	4462				
	M 12	5381-M12		5482-M12		4463			
	M 14	5381-M14		5482-M14					
	M 16	5381-M16		5482-M16		5054-M16			
	M 18	5381-M18		5184-M18		5054-M18			
M 24					5054-M24				
 Ribe (for Ribe)	M 5			5483-M5					
	M 6			5483-M6					
	M 7			5483-M7					
	M 8			5483-M8					
	M 9			5483-M9					
	M 10			5483-M10					
	M 12			5483-M12					
M 13			5483-M13						
M 14			5483-M14						

Bits

	6.3 ^m 		8 ^m 		10 ^m 		14 ^m 	
	25 mm	50 mm	30 mm	30 mm	75 mm	100 mm	75 mm	
 T-Star (for Torx)	T7	8217						
	T8	8208						
	T9	8209						
	T10	8190		8160	4866	4566		
	T15	8191	4590	8161	4868	4568		
	T20	8192	4591	8167	4869	4569		
	T25	8193	4592	8162	4870	4570		
	T27	8194		8169	4867	4567		
	T30	8195	4593	8163	4871	4571		
	T35	4735						
	T40	8196		8164	4872	4572		
	T45	8197		8165	4873	4573		
	T50			8166	4874	4574		
	T55			8168	4875	4575		
T60			4456	4876	4598		4576	
T70			4457				4581	
 T-Star Tamperproof (for Torx)	T7	2436						
	T8	2437						
	T9	2438						
	T10	2439		4410	4610	4710		
	T15	2440		4415	4615			
	T20	2441		4420	4620			
	T25	2442		4425	4625			
	T27	2443		4427	4627	4727		
	T30	2444		4430	4630			
	T35	4736						
	T40	2445		4440	4640			
	T45			4445	4645			
	T50			4450	4650			
	T55			4455	4655			
T60			4460	4660				
T70			4458	4670				
 PH	PH # 1	8185						
	PH # 2	8186			4601			
	PH # 3	8187		4383	4602			
	PH # 4	8188		4384				
 PZ	PZ # 1	8170	4596					
	PZ # 2	8172	4595					
	PZ # 3	8173	4597	4385				
	PZ # 4	8174		4386				
 Plain Slot	4,5 mm	8198						
	5,5 mm	8199						
	7 mm	8189						
	8 mm			4380	4599			
	10 mm			4381	4600			
	12 mm		4382					
 Internal Hexagon	3 mm	8176						
	4 mm	8177			4950	4959		
	5 mm	8178			4951	4960		
	6 mm	8179			4952	4961		
	7 mm	8182		4387	4953	4962		
	8 mm	8180		4388	4954	4963		
	10 mm	8181		4389	4955	4964		
	12 mm			4390	4956	4965		
	14 mm		4391	4957	4966			
 Spline (for XZN)	M5			4850	4859			
	M6			4851	4860			
	M8			4852	4861			
	M10			4853	4862			
	M12			4854	4863			
	M14			4864				
 Spline (for Ribe)	M5			4760		4770		
	M6			4761		4771		
	M7			4762		4772		
	M8			4763		4773		
	M9			4764		4774		
	M10			4765		4775		
	M10,3					4776		
	M11			4766		4777		
	M12			4767		4778		
	M13			4768		4779		
	M14					4780		



Quick-Finder

Bits

Quick-Finder

Quick-Finder

Adaptors / Extensions / T-Bars / Flexible Handles

Quick-Finder

Socket Adaptor

External	Internal				
	6.3m □ 1/4"	10m □ 3/8"	12.5m □ 1/2"	20m □ 3/4"	25m □ 1"
6.3m □ 1/4"		269			
Impact		171	9778		
		271	270		
10m □ 3/8"		172	173		
Impact		280		274	
		174		275	
20m □ 3/4"			272		
Impact			279		196
					195



Extension Bars

	6.3m □ 1/4"		10m □ 3/8"		12.5m □ 1/2"		20m □ 3/4"		25m □ 1"	
		Wobble		Wobble		Wobble				
50 mm	2336	2232	296			233				
75 mm			294	242	236					
100 mm	2335	2231						264		
125 mm				246	3120	234				
150 mm	2338	2220	295	243						
200 mm							266	372		
250 mm		2219		244	3121	235				
300 mm	2210									
375 mm						248				
400 mm							268	374		
450 mm				247						
500 mm	2211					249				
610 mm			3132		3134					



Sliding T-Bars

	6.3m □ 1/4"	10m □ 3/8"	12.5m □ 1/2"	20m □ 3/4"	25m □ 1"
115 mm	276				
200 mm		277			
250 mm			273		
450 mm				263	
500 mm					
560 mm					375

Sliding T-Bars

	12.5m □ 1/2"	12.5m □ 1/2"	20m □ 3/4"	25m □ 1"
250 mm	Repair Set	265	265-Repair	Repair Set
450 mm	9880	9880-REP		
610 mm		267	267-Repair	
630 mm			283	283-1
1020 mm				376
				377

Spanners | Combination Spanners



Metric

hot forged,
Type A,
ring end
15° offset

cold forged,
Type A,
ring end
15° offset

satin finish,
Type A,
ring end
15° offset

extra deep,
mirror polished,
Type A,
ring end
15° offset

cold forged,
Type B,
deep offset

extra short,
stubby Type

hot forged
opening end 15°
cranked
burnished

4 mm		30554					
4,5 mm		30553					
5 mm		30552					
5,5 mm		30555					
6 mm	1056	30556	30506	1228-6	30106		34206
7 mm	1057	30557	30507	1228-7	30107		34207
8 mm	1058	30558	30508	1228-8	30108		34208
9 mm	1059	30559	30509	1228-9	30109		34209
10 mm	1060	30560	30510	1228-10	30110	30761	34210
11 mm	1061	30561	30511	1228-11	30111	30760	34211
12 mm	1062	30562	30512	1228-12	30112	30762	34212
13 mm	1063	30563	30513	1228-13	30113	30763	34213
14 mm	1064	30564	30514	1228-14	30114	30764	34214
15 mm	1065	30565	30515	1228-15	30115	30775	34215
16 mm	1066	30566	30516	1228-16	30116	30776	34216
17 mm	1067	30567	30517	1228-17	30117	30765	34217
18 mm	1068	30568	30518	1228-18	30118	30778	34218
19 mm	1069	30569	30519	1228-19	30119	30779	34219
20 mm	1070	30570	30520		30120		
21 mm	1071	30571	30521	1229-21	30121		34221
22 mm	1072	30572	30522	1229-22	30122		34222
23 mm		30573	30523		30123		34223
24 mm	1074	30574	30524	1229-24	30124		34224
25 mm	1075		30525		30125		34225
26 mm	1076		30526		30126		
27 mm	1077	30577	30527	1229-27	30127		34227
28 mm			30528		30128		
29 mm					30129		
30 mm	1080	30578	30530	1229-30	30130		34230
32 mm	1082	30579	30532	1229-32	30132		34232
34 mm		1084			30134		34234
36 mm		1086			30136		34236
38 mm		1088					34238
41 mm		1091			30141		34241
46 mm		1096			30146		34246
50 mm							34250
55 mm							34255
60 mm		1100					34260
65 mm							34265
70 mm							34270
75 mm							34275
80 mm							34280
85 mm							34285
90 mm							34290
95 mm							34295



Spanners



Hot Forging

Traditional hot forging at temperatures of up to 1200° C. Perfect formability and stability.



Cold Forging

A high quality steel mixture is formed “cold” without heating the steel externally. This allows an even higher quality and very little dimension tolerances.

Spanners | Double Ring Spanner

QF Quick-Finder

Spanners

QF Quick-Finder

CV



ZOLL
INCH
1/4" 3/8" 1/2"
EN POUCHES
PULGADAS

hot forged,
Type A,
ring end
15° offset



ZOLL
INCH
1/4" 3/8" 1/2"
EN POUCHES
PULGADAS

cold forged,
Type A,
ring end
15° offset



cold forged
extra deep,
mirror polished,
straight shape



E-Type Ring Heads
hot forged
straight shape



deep offset
E-Type Ring Heads
hot forged

1/4"	30188			
5/16"	30189			
3/8"	30190			
7/16"	30191			
1/2"	30192			
9/16"	30193			
5/8"	30194			
11/16"	30195			
3/4"	30196			
13/16"	30197			
7/8"	30198			
15/16"	30199			
19/32"		30673		
25/32"		30675		
10x11 mm			1186-10x11	
12x14 mm			1186-12x14	
13x15 mm			1186-13x15	
16x18 mm			1186-16x18	
17x19 mm			1186-17x19	
21x23 mm			1186-21x23	
22x24 mm			1186-22x24	
E6xE8				2260
E7xE11				2265
E10xE12				2261
E14xE18				2262
E16xE22				2266
E20xE24				2263
				2281-6X8
				2281-10X12
				2281-14X18
				2281-20X24

Spanners | Double Ring and Double Open End Spanners

CV



Metric	DIN 838, hot forged, deep offset	DIN 838, cold forged, deep offset	C-Type, cold forged	S-Type, cold forged	extra flat, cold forged	DIN 3110, hot forged	DIN 3110, cold forged
5x5,5 mm							30605
6x7 mm	1214-6x7	30206			30330	1184-6x7	30606
8x9 mm	1214-8x9	30208			30331	1184-8x9	30608
8x10 mm			30721				
10x11 mm	1214-10x11	30210		30741	30332	1184-10x11	30610
10x13 mm		30211				1184-10x13	30613
11x13 mm			30722				
12x13 mm	1214-12x13	30212		30742	30333	1184-12x13	30612
13x17 mm		30213					
14x15 mm	1214-14x15	30214	30723	30743	30334	1184-14x15	30614
14x17 mm		30215					30611
16x17 mm	1214-16x17	30216		30744	30335	1184-16x17	30616
17x19 mm		30217	30724				30617
18x19 mm	1214-18x19	30218		30745	30336	1184-18x19	30618
19x22 mm		30223					30623
20x21 mm							
20x22 mm	1214-20x22	30220			30337	1184-20x22	30620
21x22 mm			30725				
21x23 mm	1214-21x23	30221				1184-21x23	30621
22x24 mm							30622
24x27 mm	1214-24x27	30224				1184-24x27	30624
25x28 mm	1214-25x28					1184-25x28	30625
27x30 mm							30627
30x32 mm	1214-30x32	30230				1184-30x32	30630
27x32 mm							30632
30x34 mm							30631
36x41 mm		30236				1184-36x41	30636
46x50 mm		30246					

 Double Ring / Open End Spanners
 



Hot Forging

Traditional hot forging at temperatures of up to 1200° C. Perfect formability and stability.



Cold Forging

A high quality steel mixture is formed "cold" without heating the steel externally. This allows an even higher quality and very little dimension tolerances.



QF13



2019
2020

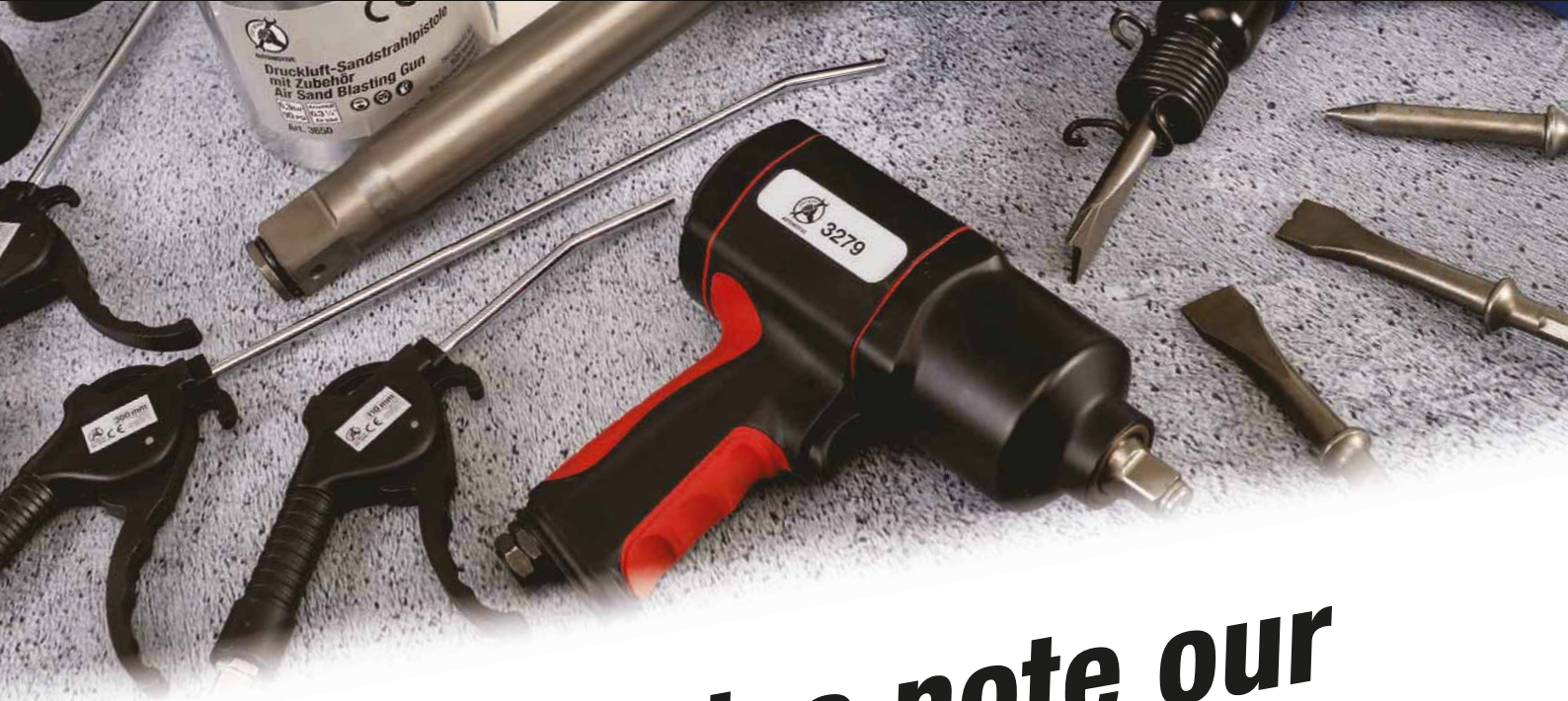

Please also note our

Catalog

2019 / 2020



HAND TOOLS**1**

Workshop Trolleys	4
Socket Sets & Tool Assortments	73
Sockets	114
Bit Sockets & Bits	151
Ratchets, Extensions, Adaptors & Accessories	183
Torque Tools	202
Hand Tools	209
Pullers	209
Axes, Splitting Hammers	218
Drills	219
Brushes	229
Figure & Letter Punches	235
Files / Grinders / Scrapers	235
Milling cutters	236
Thread Cutters	238
Hooks & Pin Wrenches	250
Hammers	251
Chisels / Centre Punches / Cotter Pin Drives	254
Knives/ Shears / Blades	259
Gauges	264
Nut Splitters	268
Pipe Processing	269
Saws / Saw Blades	271
Sanitary Tools	273
Scrapers	277
Grinding and Polishing	278
Screwdrivers	282
Spanners	295
Vices / Quick Action Bar Clamps	324
Stud Bolt Pullers	326
Stepped Hole Cutters / Taper Cutters	328
Tool Cases and Bags (universal)	331
L-type Wrenches	332
Pliers	341
Pneumatic Tools	386
Electric / Cordless Battery Tools	426

BGS Workshop Trolley - Modular – System

A clearly arranged workshop trolley has many benefits!

With our high-quality dual component soft foam Tool Trays in 4 different sizes, now you can individually configure your BGS workshop trolley with the tools that you need according to your requirements.

Made to fit recesses give your tools a non-slip support and indicate the respective location of the tool. The soft foam Tool Trays are resistant against oil and grease, are ultra-light and clearly arranged for quick access. Due to the colour coding, missing tools are noticed immediately. The Tool Tray is easy to clean by briefly rinsing under running water and then drying.

Step 1
Choose the workshop trolley
(Page 6 - 9)

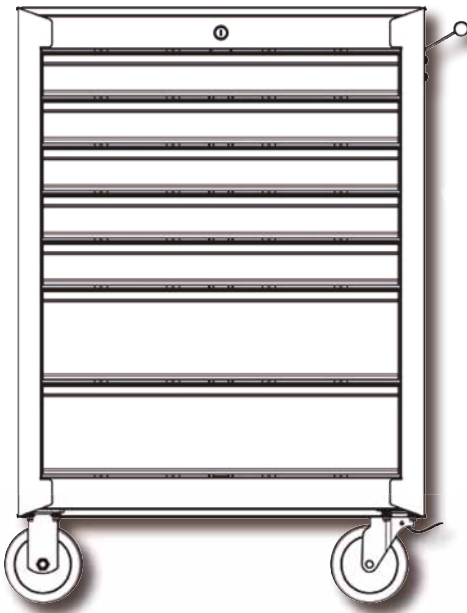

Step 2
Select any number of modules
(Page 10 - 33)

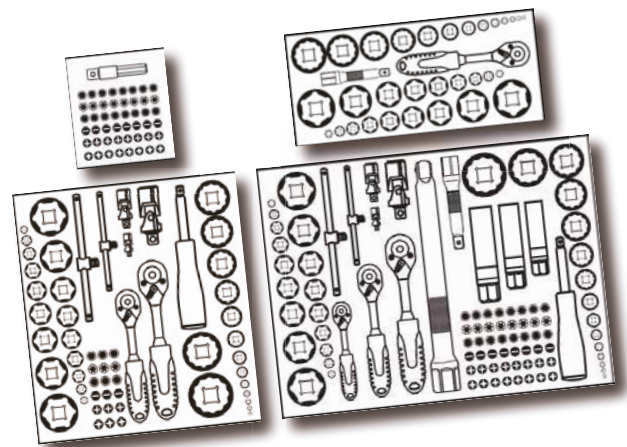

Benefits:

- can be combined individually
- resistant against oil and grease
- easy to clean
- can also be used without workshop trolley
- clearly and perfectly organised workshop trolley
- tools embedded anti-slip
- missing tools can be noticed immediately



Workshop Trolley Tool Trays

- made from high-resistance foam
- resistant against oil and grease
- the Tool Tray is easy to clean by briefly rinsing under running water and then drying
- missing tools are noticed immediately thanks to the two colour system
- tools embedded anti-slip
- everything is organised perfectly for workshop use

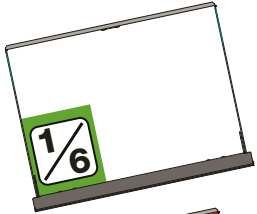

- can be combined 1/6 with one 1/6 and two 1/3 Tool Trays or five other 1/6 Tool Trays
- Dimensions: 32 x 189 x 204 mm (HxWxL)

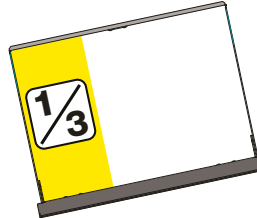

- can be combined 1/3 with the 2/3 Tool Tray or two other 1/3 Tool Trays
- dimensions: 32 x 189 x 408 mm (HxWxL)



- can be combined 2/3 with the 1/3 Tool Tray or two 1/6 Tool Trays
- Dimensions: 32 x 378 x 408 mm (HxWxL)

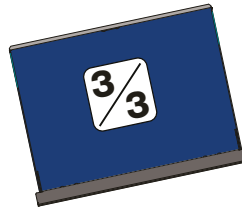

- Dimensions: 32 x 567 x 408 mm (HxWxL)



With the BGS Workshop Trolley Modular System, you design “your” workshop trolley according to your own ideas!



Workshop Trolley Pro Standard Max | with 263 Tools

- consisting of workshop trolley BGS 4111 and tool box (BGS 4112) incl. 5 tool trays for workshop trolleys, 3/3 made from high-resistance foam (dimensions 567 x 408 x 32 mm)
- Pliers, Parallel Pin Punch Set, Hammer | 17 pcs. (BGS 4011)
- Combination Spanners and E-Type Spanners Assortment | 22 pcs. (BGS 4012)
- Screwdriver Set | 23 pcs. (BGS 4014)
- Socket Set | 80 pcs. (BGS 4015)
- Bit and Bit Socket | 104 pcs. (BGS 4017)
- number of drawers: 12
- drawer pull-out: 100 %
- drawer width: 569 mm
- drawer depth: 409 mm
- drawer height: 7 x 40 | 1 x 70 | 3 x 100 | 1 x 150 mm
- width: 730 mm
- height: 1460 mm
- depth: 480 mm
- weight: 149 kg

Item #
4088

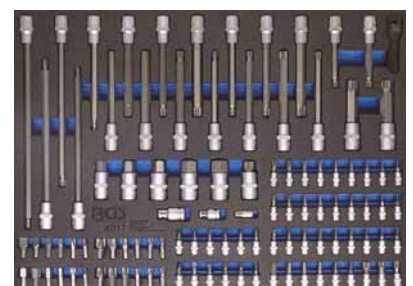
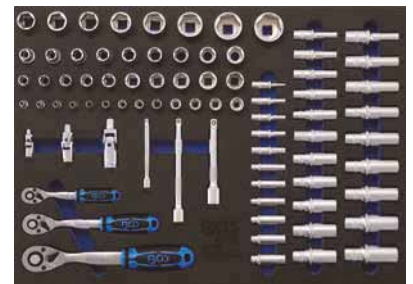

Workshop Trolley Profi Exclusive | with 259 Tools

- consisting of workshop trolley BGS 4111 incl. 19 tool trays, made from high-resistance foam

Tool tray for workshop trolleys 1/3 (dimensions 189 x 408 x 32 mm)

- Socket Set | 10 mm (3/8") | 26 pcs. (BGS 4052)
- Socket Set | 6.3 mm (1/4") | 41 pcs. (BGS 4054)
- Bit-Socket Set | internal Hexagon | 12.5 mm (1/2") | 12 pcs. (BGS 4092)
- Bit and Bit Socket Assortment | 27 pcs. (BGS 4097)
- Sockets Hexagon | 6.3 mm (1/4") | 4 - 13 mm | deep | 11 pcs. (BGS 4059)
- Sockets Hexagon | 10 mm (3/8") | 8 - 19 mm | deep | 11 pcs. (BGS 4058)
- Sockets Hexagon | 12.5 mm (1/2") | 10-24 mm | deep | 9 pcs. (BGS 4057)
- Combination Spanner Set | 6 - 22 mm | 12 pcs. (BGS 4082)
- Double Ring Spanner Set | 6x7 - 20x22 mm | deep offset ends | 8 pcs. (BGS 4084)
- Pliers Set | 3 pcs. (BGS 4042)
- Circlip Pliers Set | 4 pcs. (BGS 4025)
- Stoning and Machinist's Hammer Set | 2 pcs. (BGS 4046)
- Locking Pliers | 4 pcs. (BGS 4040)
- Extension Bar, Adaptor and Joint Set | 18 pcs. (BGS 4051)
- Handheld Lamp & Magnetic Lifter | 3 pcs. (BGS 4032)

Tool tray for workshop trolleys 2/3 (dimensions 378 x 408 x 32 mm)

- Socket Set 12.5 mm (1/2") | 27 pcs. (BGS 4053)
- Ratchet Wrenches | 90° adjustable | 8 - 19 mm | 12 pcs. (BGS 4077)
- Screwdriver Set | 12 pcs. (BGS 4122)

Tool tray for workshop trolleys 3/3 (dimensions 567 x 408 x 32 mm)

- Special Tools for Tyre Service | 18 pcs. (BGS 4035)

- number of drawers: 8
- drawer pull-out: 100 %
- drawer width: 569 mm
- drawer depth: 409 mm
- drawer height: 4 x 40 | 3 x 100 | 1 x 150 mm
- width: 730 mm
- height: 1030 mm
- depth: 480 mm
- weight: 109 kg



Workshop Trolleys

Item #
4114



Workshop Trolley Pro Standard | with 234 Tools

- consisting of workshop trolley BGS 4111 incl. 7 tool trays, made from high-resistance foam

Tool trays for workshop trolleys 1/3:

- Pliers Set | 3 pcs. (BGS 4042)
- Handheld Lamp & Magnetic Lifter | 3 pcs. (BGS 4032)
- Stoning and Machinist's Hammer set | 2 pcs. (BGS 4046)

Tool trays for workshop trolleys 3/3:

- Combination Spanner and E-Type Spanners Assortment | 22 pcs. (BGS 4012)
- Screwdriver Set | 23 pcs. (BGS 4014)
- Socket Set | 80 pcs. (BGS 4015)
- Bit and Bit Socket | 104 pcs. (BGS 4017)

- number of drawers: 8
- drawer pull-out: 100 %
- drawer width: 569 mm
- drawer depth: 409 mm
- drawer height: 4 x 40 | 3 x 100 | 1 x 150 mm
- width: 730 mm
- height: 1030 mm
- depth: 480 mm
- weight: 104 kg

Item #
4113

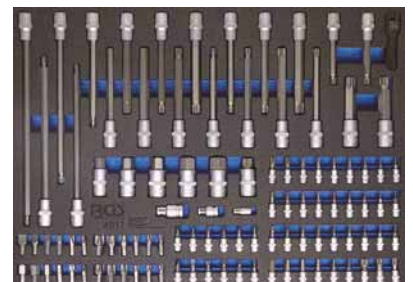
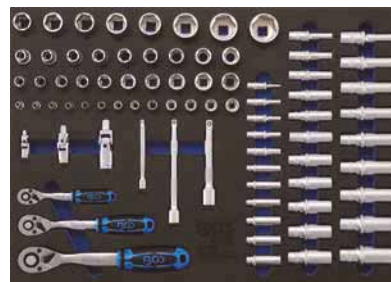
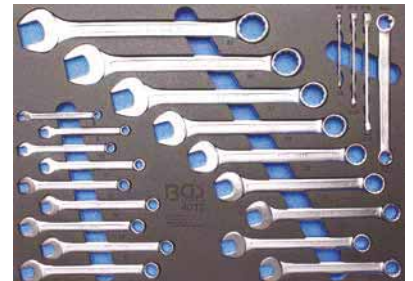

Workshop Trolley | 8 Drawers | with 296 Tools

- consisting of workshop trolley BGS 4100 incl. 8 tool trays, 3/3 made from high-resistance foam (dimensions 567 x 408 x 32 mm)
 - Screwdriver with T-Handle and side Blade | internal Hexagon / T-Star (for Torx) 18 pcs. (BGS 4010)
 - Pliers, Parallel Pin Punch Set, Hammer | 17 pcs. (BGS 4011)
 - Combination Spanners and E-Type Spanners Assortment | 22 pcs. (BGS 4012)
 - T-Handle Socket Set | 9 pcs. (BGS 4013)
 - Screwdriver Set | 23 pcs. (BGS 4014)
 - Socket Set | 80 pcs. (BGS 4015)
 - Double Open End Spanner, Double Ring Spanner, Ratchet Wrench | 26 pcs. (BGS 4016)
 - Bit and Bit Socket | 104 pcs. (BGS 4017)
-
- number of drawers: 8
 - drawer pull-out: 100 %
 - drawer width: 569 mm
 - drawer depth: 409 mm
 - drawer height: 6 x 80 | 2 x 110 mm
 - width: 730 mm
 - height: 1035 mm
 - depth: 480 mm
 - weight: 124.5 kg

Item #
4050

CV

CV-S2

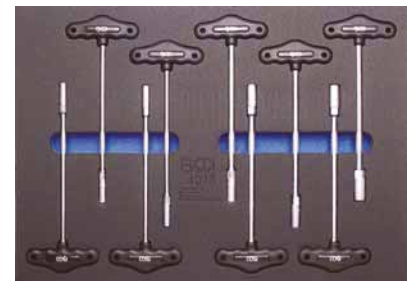
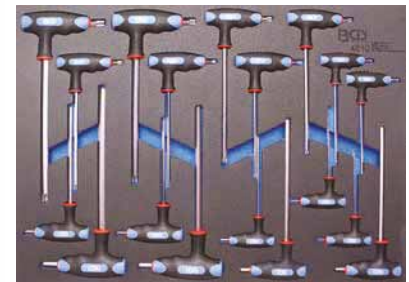
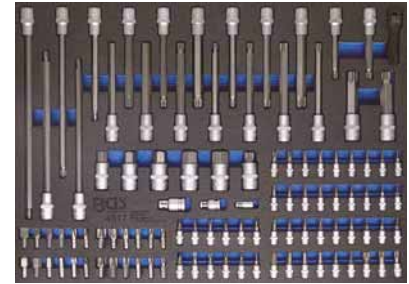
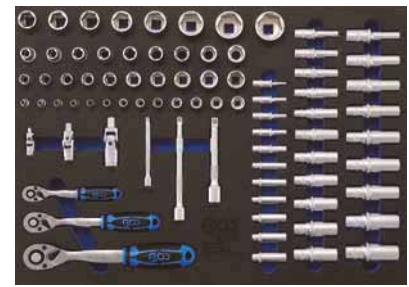

Workshop Trolleys

Workshop Trolley | 8 Drawers | with 293 Tools

- consisting of workshop trolley BGS 4100 incl. 4 tool trays, 3/3 made from high-resistance foam (dimensions 567 x 408 x 32 mm)
- Combination Spanners and E-Type Spanners Assortment | 22 pcs. (BGS 4012)
- Sockets Set | 80 pcs. (BGS 4015)
- Bit and Bit Sockets | 104 pcs. (BGS 4017)
- Sockets / Combination Spanners | inch sizes | 90 pcs. (BGS 4020)
- number of drawers: 8
- drawer pull-out: 100 %
- drawer width: 569 mm
- drawer depth: 409 mm
- drawer height: 6 x 80 | 2 x 110 mm
- width: 730 mm
- height: 1035 mm
- depth: 480 mm
- weight: 115 kg

Item #
4090

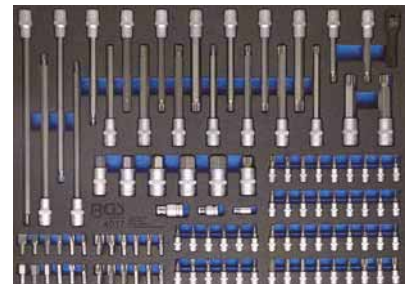
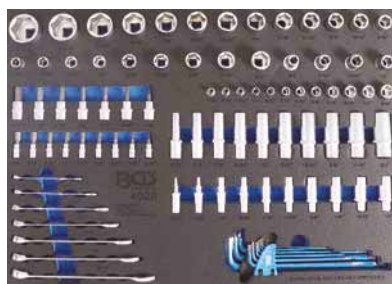
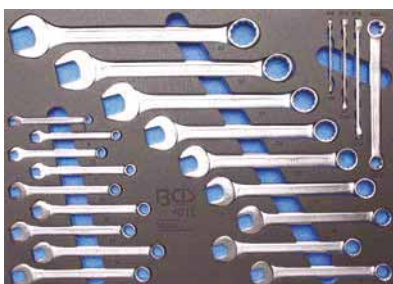
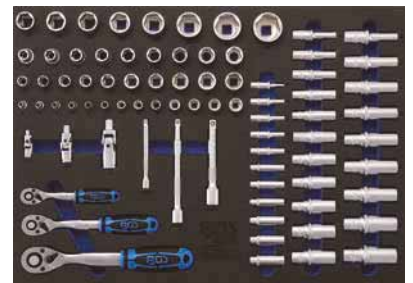

Workshop Trolley | 7 Drawers | with 243 Tools

- consisting of workshop trolley BGS 2001 incl. 5 tool trays, 3/3 made from high-resistance foam (dimensions 567 x 408 x 32 mm)
- Pliers, Parallel Pin Punch Set, Hammer | 17 pcs. (BGS 4011)
- Combination Spanners and E-Type Spanners Assortment | 22 pcs. (BGS 4012)
- Screwdriver Set | 23 pcs. (BGS 4014)
- Socket Set | 80 pcs. (BGS 4015)
- Bit and Bit Sockets | 104 pcs. (BGS 4017)
- number of drawers: 7
- drawer pull-out: 100 %
- drawer width: 569 mm
- drawer depth: 409 mm
- drawer height: 5 x 52 | 2 x 130 mm
- width: 680 mm
- height: 1000 mm
- depth: 458 mm
- weight: 88 kg

Item #
4060

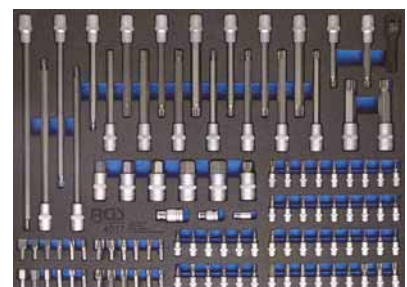
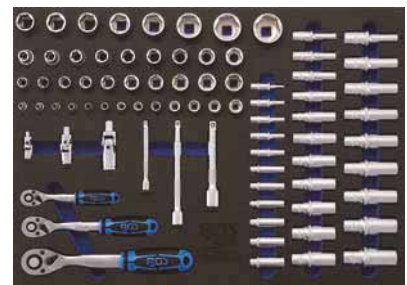

Workshop Trolley | 7 Drawers | with 120 Tools

- consisting of workshop trolley product 2001 incl. 9 tool trays, 1/3 made from robust, high-grade foam, (dimensions 189 x 408 x 32 mm)
 - Socket Set | 12.5 mm (1/2") | 27 pcs. (BGS 4126)
 - Socket Set | 6.3 mm (1/4") | 50 pcs. (BGS 4127)
 - Pliers Set | 3 pcs. (BGS 4042)
 - Ratchet Wrench Set | 8-19 mm | 12 pcs. (BGS 4128)
 - Double Ring Spanner Set | 6x7 - 20x22 mm | deep offset Ends | 8 pcs. (BGS 4084)
 - Screwdriver Set | 11 pcs. (BGS 4131)
 - Circlip Pliers Set | 4 pcs. (BGS 4025)
 - Stoning and Machinist's Hammer | 2 pcs. (BGS 4046)
 - Handheld Lamp and Magnetic Lifter | 3 pcs. (BGS 4032)
 - BGS® Football (BGS BALL)
 - Microfibre Cloth (BGS CLOTH)
 - BGS® Coffee Cup (BGS CUP)
- number of drawers: 7
 - drawer pull-out: 100 %
 - drawer width: 569 mm
 - drawer depth: 409 mm
 - drawer height: 5 x 52 | 2 x 130 mm
 - width: 680 mm
 - height: 1000 mm
 - depth: 458 mm
 - weight: 81 kg

Item #
4061

CV

CV-S2



Workshop Trolleys

Workshop Trolley | 7 Drawers | with 263 Tools

- consisting of workshop trolley BGS 2001 incl. 3 tool trays, 3/3 made from high-resistance foam (dimensions 567 x 408 x 32 mm)
- Socket Set | 192 pcs. (BGS 4036)
- Hammer, Pliers, Screwdriver Set | 36 pcs. (BGS 4038)
- Open End / Ring Spanners | 35 pcs. (BGS 4089)
- number of drawers: 7
- drawer pull-out: 100 %
- drawer width: 569 mm
- drawer depth: 409 mm
- drawer height: 5 x 52 | 2 x 130 mm
- width: 680 mm
- height: 1000 mm
- depth: 458 mm
- weight: 82 kg

Item #
4062



Workshop Trolleys



Workshop Trolley | 7 Drawers | with 129 Tools

- consisting of workshop trolley product 2001 incl. 6 tool trays, made of robust, high-quality hard foam

Tool tray for workshop trolleys 1/3 (dimensions 189 x 408 x 32 mm)

- Socket Set | 12.5 mm (1/2") | 27 pcs. (BGS 4126)
- Socket Set | 6.3 mm (1/4") | 50 pcs. (BGS 4127)
- Pliers Set | 3 pcs. (BGS 4042)
- Stoning and Machinist's Hammer Set | 2 pcs. (BGS 4046)

Tool tray for workshop trolleys 2/3 (dimensions 378 x 408 x 32 mm)

- 12-piece Screwdriver Set (BGS 4122)

Tool tray for workshop trolleys 3/3 (dimensions 567 x 408 x 32 mm)

- Open End / Ring Spanners | 35 pcs. (BGS 4089)

- BGS® Football (BGS BALL)
- Microfibre Cloth (BGS CLOTH)
- BGS® Coffee Cup (BGS CUP)

- number of drawers: 7
- drawer pull-out: 100 %
- drawer width: 569 mm
- drawer depth: 409 mm
- drawer height: 5 x 52 | 2 x 130 mm
- width: 680 mm
- height: 997 mm
- depth: 458 mm
- weight: 81 kg

Item #
4080

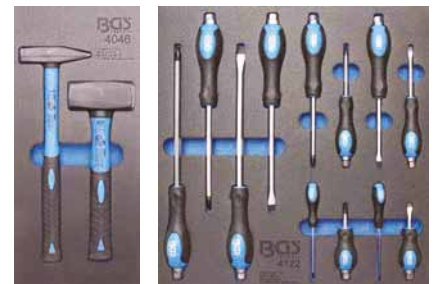

Workshop Trolley „Trainee“ | with 151 Tools

- consisting of workshop trolley BGS 2004 incl. 7 tool trays, made from high-resistance foam

Tool tray for workshop trolleys 1/3 (dimensions 189 x 408 x 32 mm) :

- Socket Set | 6.3 mm (1/4") | 41 pcs. (BGS 4054)
- Stoning and Machinist's Hammer Set | 2 pcs. (BGS 4046)
- Combination Spanner Set | 6 - 22 mm | 12 pcs. (BGS 4082)
- Double Ring Spanner Set | 6x7 - 20x22 mm | deep offset ends | 8 pcs. (BGS 4084)
- Combined bit Set | 49-piece (BGS 4093)

Tool tray for workshop trolleys 2/3 (dimensions 378 x 408 x 32 mm) :

- 12-piece Screwdriver Set (BGS 4122)
- Socket Set 12.5 mm (1/2") | 27 pcs. (BGS 4053)

- number of drawers: 4
- drawer pull-out: 100 %
- drawer width: 569 mm
- drawer depth: 409 mm
- drawer height: 4 x 52 mm
- storage dimensions: 560x395x410 mm
- width: 680 mm
- height: 995 mm
- depth: 458 mm
- weight: 64 kg

Item #
4086

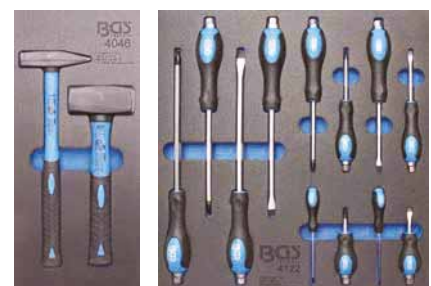
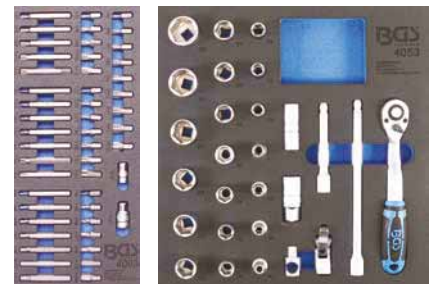

Workshop Trolley | 7 Drawers | Engine Timing Tool Sets

• consisting of workshop trolley BGS 2001 incl. 6 workshop tool trays 3/3 (dimensions 567 x 408 x 32 mm) made of robust, high-quality hard foam

- Engine Timing Tool Set | for Renault, Nissan, Opel, Volvo (BGS 4134)
- Engine Timing Tool Set | for Fiat, Ford, Citroen, Peugeot (BGS 4135)
- Engine Timing Tool Set | for Ford, VAG, Mazda, Volvo (BGS 4136)
- Engine Timing Tool Set | for Fiat, Alfa, Lancia, Opel, Suzuki, Ford (BGS 4137)
- Engine Timing Tool Set | for Fiat, Alfa, Lancia, Opel, Suzuki, Ford (BGS 4138)
- Engine Timing Tool Set | for Ford, VW, Seat, Mazda, Volvo (BGS 4139)

- width: 680 mm
- height: 997 mm
- depth: 458 mm
- weight: 102 kg
- number of drawers: 7 pieces
- drawer pull-out: 100 %
- drawer width: 569 mm
- drawer height: 5 x 52, 2 x 130 mm
- drawer depth: 409 mm

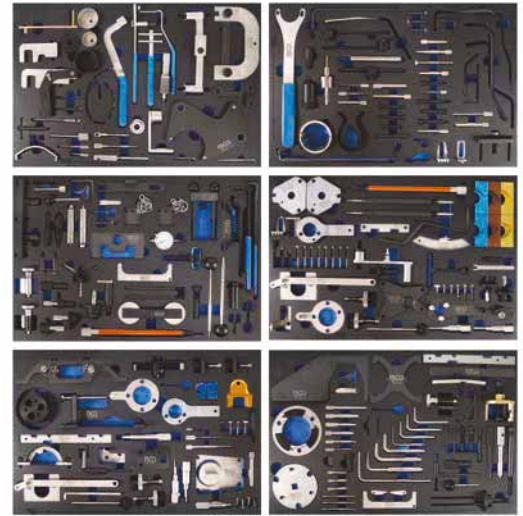

Item #		
4115		

Workshop Trolley | 7 Drawers | extra low total Height | with 209 Tools

• consisting of workshop trolley BGS 4102 incl. 3 workshop tool trays 1/3 (dimensions 189 x 408 x 32 mm) and 1 workshop tool tray 3/3 (dimensions 567 x 408 x 32 mm) made of robust, high-quality hard foam

- Socket Set | 192 pcs. (BGS 4036)
- Combination Spanner Set | 6 - 22 mm | 12 pcs. (BGS 4082)
- Stoning and Machinist's Hammer Set | 2 pcs. (BGS 4046)
- Pliers Set | 3 pcs. (BGS 4042)

- width: 724 mm
- height: 859 mm
- depth: 470 mm
- weight: 82.5 kg
- number of drawers: 7 pieces
- drawer pull-out: 100 %
- drawer width: 569 mm
- drawer height: 4 x 53, 3 x 111 mm
- drawer depth: 409 mm



Item #						
4140						

Workshop Trolley Tyre Service | with 82 Tools

- consisting of workshop trolley BGS 2004 incl. 4 tool trays, made from high-resistance foam:

tool trays for workshop trolleys 1/3

- Tyre Repair Kit | 54 pcs. (BGS 4124)
- Measuring Tool Set | 7 pcs. (BGS 4031)
- Handheld Lamp and Magnetic Lifter | 3 pcs. (BGS 4032)

tool tray for workshop trolleys 3/3

- Special Tools for Tyre Service | 18 pcs. (BGS 4047)

- length: 680 mm
- width: 458 mm
- height: 995 mm
- weight: 60 kg
- number of drawers: 4
- drawer pull-out: 100 %
- drawer width: 569 mm
- drawer height: 52 mm
- drawer depth: 409 mm



Item #
4087

Workshop Trolley | 8 Drawers | empty

- heavy duty workshop finish
- wall thickness body: 1.2 mm
- wall thickness drawers: 0.8 mm
- heavy duty 125 mm ball bearing castors, thereof 2 castors lockable
- lockable through central lock
- each drawer individually secured, with safety lock
- 8 smooth running, ball bearing drawers:
 - drawer 1 - 4 drawer capacity: each 20 kg
 - 5th to 7th drawer capacity: each 25 kg
 - 8th drawer capacity: 30 kg
- stable plastic support with 5 storage compartments, load capacity up to 50 kg
- side storage compartment: 78 x 370 x 75 mm (HxWxD)
- side mounted handle
- width: 724 mm
- height: 1033 mm
- depth: 470 mm
- weight: 89 kg
- number of drawers: 8
- drawer pull-out: 100 %
- drawer width: 569 mm
- drawer depth: 409 mm
- drawer height: 4 x 54, 3 x 112, 1 x 170 mm



Item #
4111

Workshop Trolley | 7 Drawers | extra low total Height | empty

- heavy duty workshop finish
- wall thickness body: 1.2 mm
- wall thickness drawers: 0.8 mm
- low height: 85.9 cm
- heavy duty 125 mm ball bearing castors, thereof 2 castors lockable
- lockable through central lock
- 7 smooth running, ball bearing drawers:
 - drawer 1 - 4 capacity: each 25 kg
 - drawer 5 - 7 capacity: each 30 kg
- each drawer individually secured, with safety lock
- work plate with 5 storage compartments
- side storage compartment: 78 x 370 x 75 mm (HxWxD)
- side mounted handle
- width: 724 mm
- height: 859 mm
- depth: 470 mm
- weight: 62 kg
- number of drawers: 7
- drawer pull-out: 100 %
- drawer width: 569 mm
- drawer height: 4 x 53 | 3x 111 mm
- drawer depth: 409 mm



Item #
4102

Workshop Trolley | 8 Drawers | empty

- heavy duty workshop finish
- wall thickness body: 1.0 mm
- wall thickness drawers: 0.8 mm
- heavy duty ball bearing castors, thereof 2 castors lockable
- 2 fixed castors on one axle (160 mm)
- 2 castors (125 mm)
- lockable through central lock
- smooth-running, extendable ball bearing drawers
- each drawer individually secured, with safety lock
- with adjustable side shelf
- 8 drawers (2 extra big drawers), fully extendable
- practical work plate with storage boxes for small parts, tools etc.
- width: 724 mm
- height: 1030 mm
- depth: 470 mm
- weight: 92 kg
- number of drawers: 8 pieces
- drawer pull-out: 100 %
- drawer width: 569 mm
- drawer height: 6 x 80 | 2 x 110 mm
- drawer depth: 409 mm



Item #
4100

Workshop Trolley | 7 Drawers | empty

- 7 ball bearing drawers, 100 % extendable
 - 1st to 5th drawer: capacity up to 20 kgs (per drawer)
 - 6th to 7th drawer: capacity up to 25 kgs (per drawer)
- wall thickness body: 0.9 mm
- wall thickness drawers: 0.7 mm
- max. capacity of top rest up to 50 kgs
- heavy duty ball bearing castors, thereof 2 castors lockable
- lockable through central lock
- practical work plate with antislip plastic plate
- width: 680 mm
- height: 1000 mm
- depth: 458 mm
- weight: 60 kg
- number of drawers: 7
- drawer pull-out: 100 %
- drawer width: 569 mm
- drawer height: 5 x 52 | 2 x 130 mm
- drawer depth: 409 mm



Item #
2001

Workshop Trolley XL | empty

- heavy duty workshop finish
- wall thickness body: 1.0 - 1.2 mm
- wall thickness drawers: 0.7 - 0.8 mm
- heavy duty ball bearing castors, thereof 2 castors lockable
- lockable through central lock
- smooth-running ball bearing drawers
- 11 drawers, fully extensible in the following sizes (from top down)
 - 930 x 410 x 100 mm (max. load 40 kg)
 - 570 x 410 x 70 mm (max. load 20 kg)
 - 340 x 410 x 70 mm (max. load 20 kg)
 - 570 x 410 x 70 mm (max. load 20 kg)
 - 340 x 410 x 70 mm (max. load 20 kg)
 - 570 x 410 x 70 mm (max. load 20 kg)
 - 340 x 410 x 70 mm (max. load 20 kg)
 - 570 x 410 x 100 mm (max. load 25 kg)
 - 340 x 410 x 70 mm (max. load 25 kg)
 - 570 x 410 x 210 mm (max. load 35 kg)
 - 340 x 410 x 210 mm (max. load 35 kg)
- practical wooden work plate
- width: 1080 mm
- height: 1070 mm
- depth: 480 mm
- weight: 116 kg
- number of drawers: 11 pieces
- drawer pull-out: 100 %
- drawer width: 1 x 930 | 5 x 569 | 5 x 340 mm
- drawer height: 6 x 70 | 3 x 100 | 2 x 210 mm
- drawer depth 409



Item #
4110

Workshop Trolley | 4 Drawers, 1 folding Compartment | empty

- 4 ball bearing drawers and 1 storage compartment with retractable closure flap
- drawers and storage compartment separately lockable
- wall thickness body: 0.9 mm
- wall thickness drawers: 0.7 mm
- heavy duty ball bearing castors, thereof 2 castors lockable
- practical work plate with antislip plastic plate
- each drawer's capacity: up to 20 kg
- storage dimensions (W x D x H): 560x395x410 mm (capacity: 30 kg)
- width: 680 mm
- height: 995 mm
- depth: 458 mm
- weight: 53 kg
- number of drawers: 4
- drawer pull-out: 100 %
- drawer width: 569 mm
- drawer height: 52 mm
- drawer depth: 409 mm



Item #
2004

Workshop Trolley | 2 Drawers | Horizontal double Drawer Slide | empty

- large storage area with rubber insert
- wall thickness body: 1.5 mm
- wall thickness drawers: 0.8 - 1.5 mm
- shelf with rubber insert in double pull-out compartment
- perforated tray on the sides for e.g. T-handle sockets
- side storage space for spray cans, etc.
- large storage area in the bottom plate
- four rubber wheels and 2 swivel castors with brake
- all wheels, drawers and double extension have ball bearings
- handle for pulling or pushing
- width: 875 mm
- holder for paper rolls with a width up to 275 mm
- height: 840 mm
- depth: 370 mm
- weight: 27 kg
- number of drawers: 2
- drawer pull-out: 100 %
- drawer width: 320 mm
- drawer height: 2 x 55 mm
- drawer length: 565 mm



Item #
4105

Workshop Trolley | 1 Drawer | open Type

- particularly useful for storage of small components and tools
- 3 shelves (top, middle, bottom), internal dimensions: (W x D x H) 675 x 460 x 55 mm
- 1 drawer, extendable, capacity 25 kg, internal dimensions: (W x D x H) 565 x 400 x 55 mm
- 1 side shelf, internal dimensions: (W x D x H) 100 x 460 x 100 mm
- 2 castors Ø 100 mm, 2 swivel castors Ø 100 mm, with brake
- overall dimensions: (W x D x H) 860 x 485 x 815
- total capacity 150 kg
- length: 860 mm
- width: 485 mm
- height: 815 mm



Item #
4200

Workshop Trolley Attachment | 4 Drawers | empty

- suitable as attachment for PRO workshop trolley BGS 4111, 4102
- wall thickness body: 1.0 mm
- wall thickness drawers: 0.8 mm
- 4 smooth running, ball bearing drawers, fully extensible
- rated load capacity of each drawer: 20 kg
- each drawer individually secured, with safety lock
- 1 large storage compartment with lockable and hydraulically operated closure lid, inside dimensions: (W x D x H) 610 x 420 x 75 mm
- side storage: (W x D x H) 370 x 75 x 78 mm
- 2 side-mounted handles
- length: 730 mm
- width: 480 mm
- height: 430 mm
- weight: 44 kg
- number of drawers: 4 pieces
- drawer width: 569 mm
- drawer height: 3 x 40 | 1 x 70 mm
- drawer depth: 409 mm



Item #
4112

Workshop Trolley Attachment | 3 Drawers | empty

- suitable as attachment for BGS 2001
- wall thickness body: 0.8 mm
- wall thickness drawers: 0.6 mm
- 2 flat, 1 higher drawer
- 1 large storage compartment
- with lockable closure lid
- side-mounted handles
- ball bearing drawers
- length: 660 mm
- width: 310 mm
- height: 375 mm
- weight: 25 kg
- number of drawers: 4
- drawer width: 560 mm
- drawer height: 3 x 40 | 1x 70 mm
- drawer depth: 395 mm



Item #
4001

Metal Tool Box, empty | 3 Drawers

- 3 drawers
- 1 upper compartment with lid
- lockable, lock with optical control, red = closed, green = opened
- drawers are locked when the lid is closed
- 2 side metal handles
- 1 upper plastic handle
- compartment internal dimensions (W x D x H) 515 x 215 x 90 mm
- drawers internal dimensions (W x D x H) 500 x 200 x 45 mm
- length: 535 mm
- width: 290 mm
- height: 240 mm



Item #
3312

Mobile Assembly Trolley

- consists of three removable parts: 1 box with flap lid and carrying handle, 2 drawers, 1 big box with front lid
- ideal for e.g. assembly workers, mechanics, electricians, etc.
- removable upper and middle box are lockable with the box below
- length: 530 mm
- width: 320 mm
- height: 720 mm
- castor diameter: 125 mm
- max. load bearing capacity: 75 kg



Item #
2002

Assembly Cart Attachment | for BGS 2002

- box detachable and lockable with box below
- 1 drawer
- ideal for e.g. assembly workers, mechanics, electricians, etc.
- dimensions: 500 x 250 x 180 mm



Item #
2002-1

Mobile Table

- adjustable height via telescopic square tube, from 880 to 1180 mm
- dimensions: W 754 x D 515 mm
- 1 large shelf, inner dimensions: W 730 x D 430 x H 20 mm
- 3 small shelves, inner dimensions: W 240 x D 70 x H 20 mm
- 4 castors, Ø 60 mm
- capacity: 23 kg
- length: 754 mm
- width: 515 mm



Item #
4101

Tool Tray 1/6: Impact Bit Socket Set | 6.3 mm (1/4") | 40 pcs.

6.3 1/4

- suitable for both manual and impact use
- extra short version
- 10x T-Star (for Torx): T10 - T15 - T20 - T25 - T27 - T30 - T40 - T45 - T47 - T50
- 5x T-Star (for Torx) tamperproof : TH30 - TH40 - TH45 - TH47 - TH50
- 5x Spline (for XZN): M4 - M5 - M6 - M8 - M10
- 4x Spline (for XZN) tamperproof : MH5 - MH6 - MH8 - MH10
- 3x Square (for Robertson): 1 - 2 - 3
- 4x slot SL: 3 mm - 4 mm - 5.5 mm - 7 mm
- 7x internal hexagon: H3 - H4 - H5 - H6 - H7 - H8 - H10
- 4x cross slot PH: PH: PH1 - PH2 - PH3

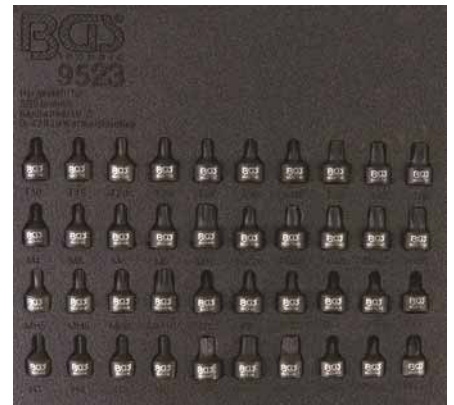

Item #
9523



Tool Tray 1/6: Ratchet Wrench | 4 pcs.

- retraction angle 5°, 72 teeth
- ratchet wrench 8 mm, BGS 30828
- ratchet wrench 10 mm, BGS 30830
- ratchet wrench 11 mm, BGS 30831
- ratchet wrench 12 mm, BGS 30832
- width: 189 mm
- height: 32 mm
- depth: 204 mm



Item #	Description
30833	Tool Tray 1/6: Ratchet Wrench 4 pcs.
30833-1	Tool Tray 1/6, empty for Item 30833



Tool Tray 1/6: High Pressure Pump Sprocket Puller | for Common-Rail | Hyundai & Kia

- to remove the high pressure pump sprocket when dismantling the high pressure pump on Common Rail Diesel vehicles from Hyundai and Kia
- suitable for following vehicles:
KIA Carens (UN), Cee'd (ED) & (JD), Optima (TF), Rio (UB), Soul (AM), Sportage (SL) & (SLE), Venga (YN), Soul (PS), Hyundai Matrix, Getz, i30
- engine codes: 1.1D (TCI-U2), 1.4D (TCI-U2), 1.6D (TCI-U2), 1.7D (TCI-U2), 1.6 TCI (U2), 1.4 CRDi (U2), 1.6 CRDi (U2)
- contains: high pressure pump removal tool, to be used as OEM 093312A010, consisting of base plate, sprocket stopper, mounting screws

Item #	Image	1/6
9497		



Tool Tray 1/6: Thread Repair Kit | for Injector Fastening Screws | 10 pcs.

- suitable for Mercedes Benz CDI engines
- for reaming the broken-off expansion bolt & repairing the M6 thread in the cylinder head
- time saving as the replacement of the cylinder head and the removal of injectors and valve covers is not necessary
- damaged thread is reworked to size M8 x 1
- 1 twist drill 6 mm, with adjusting ring for drilled depth
- 1 step drill 7 to 8 mm, with adjusting ring for drilled depth
- 1 guide sleeve for 6 mm twist drill
- 1 tap M8x1
- 1 assembly tool for threaded inserts
- 5 threaded inserts, inner thread M6x1 / outer thread M8x1

Item #	Image	1/6
9538		



Tool Tray 1/3: Socket Set | 50 pcs.

6.3  1/4

- 1 spinner handle, 150 mm
- 2 extensions, length: 50 + 100 mm
- 1 universal joint
- 1 sliding bar 114 mm
- 1 reversible ratchet, offset design, fine toothed, 72 teeth with quick release function
- 6 bit sockets, T-Star tamperproof (for Torx): T10 - T15 - T20 - T25 - T30 - T40
- 6 bit sockets, internal hexagon: 3 - 4 - 5 - 6 - 7 - 8 mm
- 3 bit sockets, slot sl: 4 - 5.5 - 6.5 mm
- 3 x bit sockets, cross slot PH: PH1 - PH2 - PH3
- 13 sockets, hexagon Pro Torque®, 4 - 4.5 - 5 - 5.5 - 6 - 7 - 8 - 9 - 10 - 11 - 12 - 13 - 14 mm
- 7 sockets, E-type, E4 - E5 - E6 - E7 - E8 - E10 - E11
- 6 sockets, deep, hexagon Pro Torque®, 8-10-11-12-13-14 mm
- surface finish: satin chrome plated
- width: 189 mm
- height: 32 mm
- depth: 408 mm



Item #	Description
4127	Tool Tray 1/3: Socket Set 50 pcs.
4127-1	Tool Tray 1/3, empty for Item 4127

Tool Tray 1/3: Socket Set | 41 pcs.

6.3  1/4

- 1 socket adapter external hexagon of external square 6.3 mm (1/4")
- 1 spinner handle
- 2 extensions, length: 50 + 100 mm
- 1 universal joint
- 1 flexible extension bar
- 1 reversible ratchet with quick release button
- 6 bit sockets, T-Star tamperproof drive (for Torx): T10 - T15 - T20 - T25 - T30 - T40
- 6 bit sockets, internal hexagon: 3 - 4 - 5 - 6 - 7 - 8 mm
- 3 bit sockets, plain slot drive: 4 - 5 - 7 mm
- 3 bit sockets, cross slot drive PH: PH1 - PH2 - PH3
- 3 bit sockets, cross slot drive PZ: PZ1 - PZ2 - PZ3
- 13 Super Lock sockets: 4 - 4.5 - 5 - 5.5 - 6 - 7 - 8 - 9 - 10 - 11 - 12 - 13 - 14 mm
- surface finish: satin chrome plated
- width: 189 mm
- height: 32 mm
- depth: 408 mm

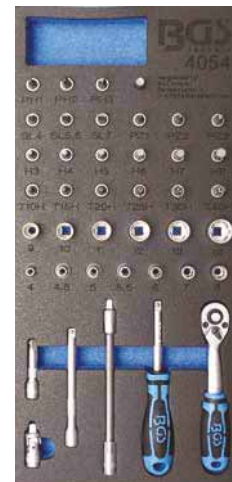

Item #	Description
4054	Tool Tray 1/3: Socket Set 41 pcs.
4054-1	Tool Tray 1/3, empty for Item 4054

Tool Tray 1/3: Socket Set | 26 pcs.

10  3/8

- sockets in hexagon Pro torque® design

Socket Set | 10 mm (3/8") | 26 pcs.

- 18 knurled sockets, satin chrome plated, internal square drive 10 mm (3/8"), hexagon drive 6 - 24 mm
- 3 extension bars, lengths: 45 - 75 - 150 mm
- 2 spark plug sockets 16 - 21 mm
- 1 universal joint
- reversible ratchet with quick release button
- adaptor 10 mm (3/8") - 12.5 mm (1/2")
- surface finish: satin chrome plated
- width: 189 mm
- height: 32 mm
- depth: 408 mm



Item #	Description
4052	Tool Tray 1/3: Socket Set 26 pcs.
4052-1	Tool Tray 1/3, empty for Item 4052

Tool Tray 1/3: Socket Set | 27 pcs.

12.5  1/2

- sockets in hexagon Pro torque® design

Socket Set | 12.5 mm (1/2") | 27 pcs.

- 2 wobble type extension bars 125 + 250 mm
- 1 adaptor for extension / sliding bar
- 1 universal joint
- 2 spark plug sockets 16 + 21 mm
- 20 sockets with Pro torque® hexagon profile in the following sizes:
8 - 9 - 10 - 11 - 12 - 13 - 14 - 15 - 16 - 17 - 18 - 19 - 20 - 21 - 22 - 23 - 24 - 27 - 30 - 32 mm
- surface finish: satin chrome plated
- width: 189 mm
- height: 32 mm
- depth: 408 mm



Item #	Description
4126	Tool Tray 1/3: Socket Set 27 pcs.
4126-1	Tool Tray 1/3, empty for Item 4126

Tool Tray 1/3: Sockets 12-point | 29 pcs.

6.3  1/4 12.5  1/2

- 16 12-point sockets, 12.5 mm (1/2") drive: 8 - 9 - 10 - 11 - 12 - 13 - 14 - 15 - 16 - 17 - 18 - 19 - 20 - 21 - 22 - 24 mm
- 13 12-point sockets, 6.3 mm (1/4") drive: 4 - 4.5 - 5 - 5.5 - 6 - 7 - 8 - 9 - 10 - 11 - 12 - 13 - 14 mm
- surface finish: satin chrome plated
- width: 189 mm
- height: 32 mm
- depth: 408 mm

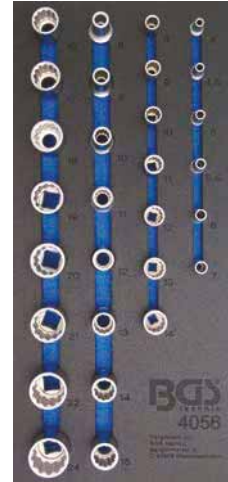

Item #	Description
4056	Tool Tray 1/3: Sockets 12-point 29 pcs.
4056-1	Tool Tray 1/3, empty for Item 4056

Tool Tray 1/3: Sockets, Hexagon | deep | 11 pcs.

6.3  1/4

- Pro torque® finish, deep
- knurled
- 11 sockets, 6.3 mm (1/4") drive, sizes: 4 - 5 - 5.5 - 6 - 7 - 8 - 9 - 10 - 11 - 12 - 13 mm
- surface finish: satin chrome plated
- width: 189 mm
- height: 32 mm
- depth: 408 mm

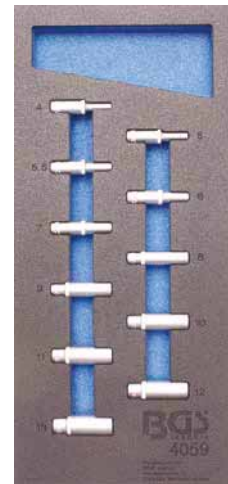

Item #	Description
4059	Tool Tray 1/3: Sockets, Hexagon deep 11 pcs.
4059-1	Tool Tray 1/3, empty for Item 4059

Tool Tray 1/3: Sockets | Inch Sizes | deep | 11 pcs.

6.3  1/4

- Pro torque® finish, deep
- knurled
- sockets, deep, internal square drive 6.3 mm (1/4"): 3/16" - 7/32" - 1/4" - 9/32" - 5/16" - 11/32" - 3/8" - 13/32" - 7/16" - 15/32" - 1/2"
- surface finish: satin chrome plated
- width: 189 mm
- height: 32 mm
- depth: 408 mm

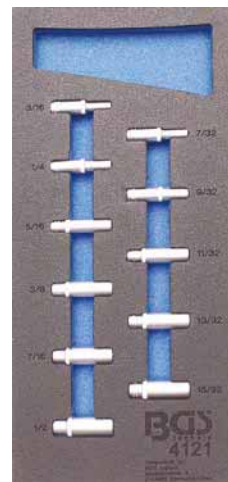

Item #	Description
4121	Tool Tray 1/3: Sockets Inch Sizes deep 11 pcs.
4121-1	Tool Tray 1/3, empty for Item 4121

Tool Tray 1/3: Sockets | Inch Sizes | deep | 11 pcs.

10  3/8

- Pro torque® finish, deep
- knurled
- 11 sockets, 10 mm (3/8") drive: 5/16" - 1/32" - 3/8" - 7/16" - 1/2" - 9/16" - 5/8" - 11/16" - 3/4" - 13/16" - 7/8"
- surface finish: satin chrome plated
- width: 189 mm
- height: 32 mm
- depth: 408 mm



Item #	Description
4099	Tool Tray 1/3: Sockets Inch Sizes deep 11 pcs.
4099-1	Tool Tray 1/3, empty for Item 4099

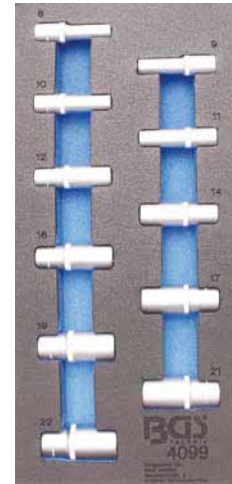

Tool Tray 1/3: Sockets, Hexagon | deep | 11 pcs.

10  3/8

- Pro torque® finish, deep
- knurled
- 11 sockets, 10 mm (3/8"): 8 - 10 - 11 - 12 - 13 - 14 - 15 - 16 - 17 - 18 - 19 mm
- surface finish: satin chrome plated
- width: 189 mm
- height: 32 mm
- depth: 408 mm



Item #	Description
4058	Tool Tray 1/3: Sockets, Hexagon deep 11 pcs.
4058-1	Tool Tray 1/3, empty for Item 4058

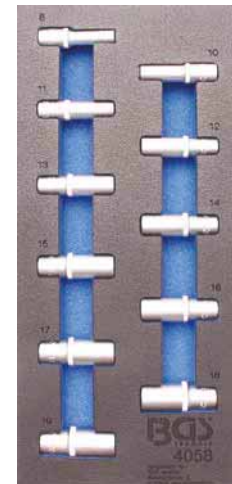

Tool Tray 1/3: Sockets | Inch Sizes | deep | 10 pcs.

12.5  1/2

- Pro torque® finish, deep
- knurled
- 10 sockets, 12.5 mm (1/2") drive: 3/8" - 7/16" - 1/2" - 9/16" - 5/8" - 11/16" - 3/4" - 13/16" - 7/8" - 15/16"
- surface finish: satin chrome plated
- width: 189 mm
- height: 32 mm
- depth: 408 mm



Item #	Description
4098	Tool Tray 1/3: Sockets Inch Sizes deep 10 pcs.
4098-1	Tool Tray 1/3, empty for Item 4098

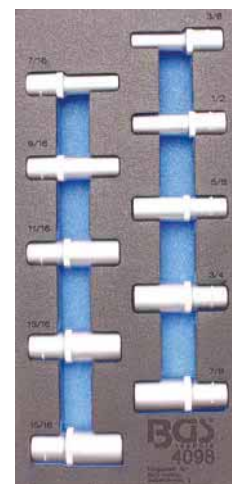

Workshop Trolley Tool Trays

Tool Tray 1/3: Sockets, Hexagon | deep | 9 pcs.

12.5  1/2

- Pro torque® finish, deep
- knurled
- 9 sockets, 12.5 mm (1/2") drive: 10 - 13 - 15 - 16 - 17 - 18 - 19 - 22 - 24 mm
- surface finish: satin chrome plated
- width: 189 mm
- height: 32 mm
- depth: 408 mm

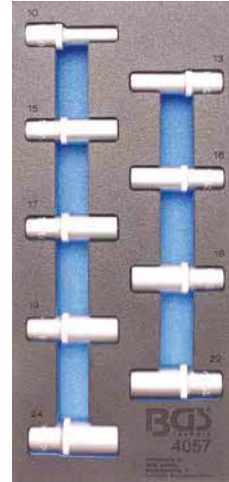

Item #	Description
4057	Tool Tray 1/3: Sockets, Hexagon deep 9 pcs.
4057-1	Tool Tray 1/3, empty for Item 4057

Tool Tray 1/3: Impact Sockets Hexagon | 20 pcs.

12.5  1/2

- impact sockets, length 38 mm 10-12-13-14-15-17-19-21-22-24 mm
- with groove and hole for retaining ball
- especially suitable for impact use
- hexagon Pro Torque® sockets
- impact sockets, length 72 mm 10-12-13-14-15-17-19-21-22-24 mm



Item #	Description
4130	Tool Tray 1/3: Impact Sockets Hexagon 20 pcs.
4130-1	Tool Tray 1/3, empty for Item 4130

Tool Tray 1/3: Combined Bit Set | 49 pcs.

- 14 bits, short and long models, external hexagon drive 10 mm (3/8"), internal hexagon: 4 - 5 - 6 - 7 - 8 - 10 - 12 mm
- 14 bits, short and long models, external hexagon drive 10 mm (3/8"), T-Star (for Torx): T20 - T25 - T30 - T40 - T45 - T50 - T55
- 10 bits, short and long models, external hexagon drive 10 mm (3/8"), spline (for XZN): M5 - M6 - M8 - M10 - M12
- 9 bits, 30 mm long, 10 mm (3/8") drive, spline (for Ribe): M5 - M6 - M7 - M8 - M9 - M10 - M11 - M12 - M13
- 1 bit adaptor, 10 mm (3/8") drive, internal hexagon 10 mm (3/8")
- 1 bit adaptor, 12.5 mm (1/2") drive, internal hexagon 10 mm (3/8")
- width: 189 mm
- height: 32 mm
- depth: 408 mm



Item #	Description
4093	Tool Tray 1/3: Combined Bit Set 49 pcs.
4093-1	Tool Tray 1/3, empty for Item 4093

Tool Tray 1/3: Bit and Bit Socket Assortment | 27 pcs.

12.5 1/2

- 5 bit sockets, knurled, 12.5 mm (1/2") drive, T-Star (for Torx): T45 - T50 - T55 - T60 - T70
- 7 bits, 6.3 mm (1/4") drive, T-Star (for Torx): T10 - T15 - T20 - T25 - T27 - T30 - T40
- 12 bits, 6.3 mm (1/4") drive, T-Star tamperproof drive (for Torx): T10 - T15 - T20 - T25 - T27 - T30 - T40 - T45 - T50 - T55 - T60 - T70
- 3 bit adaptors, internal square drive: 6.3 mm (1/4") - 10 mm (3/8") - 12.5 mm (1/2")
- width: 189 mm
- height: 32 mm
- depth: 408 mm



Item #	Description
4097	Tool Tray 1/3: Bit and Bit Socket Assortment 27 pcs.
4097-1	Tool Tray 1/3, empty for Item 4097

Tool Tray 1/3: Bit Socket Set | internal Hexagon | 12 pcs.

12.5 \square 1/2

- knurled
- 12 bit sockets, 12.5 mm (1/2") drive, internal hexagon 5 - 6 - 7 - 8 - 10 - 12 - 14 - 16 - 17 - 18 - 19 - 22 mm
- surface finish: satin chrome plated
- width: 189 mm
- height: 32 mm
- depth: 408 mm



Item #	Description
4092	Tool Tray 1/3: Bit Socket Set internal Hexagon 12 pcs.
4092-1	Tool Tray 1/3, empty for Item 4092

Tool Tray 1/3: Extension Bar, Adaptor and Joint Set | 18 pcs.

6.3 \square 1/4

10 \square 3/8

12.5 \square 1/2

- "Wobble" extension bar, 6.3 mm (1/4"), length: 50 - 100 - 250 mm
- "Wobble" extension bar, 10 mm (3/8"), length: 75 - 150 - 250 mm
- "Wobble" extension bar, 12.5 mm (1/2"), length: 50 - 125 - 250 mm
- knurled
- adaptor internal 6.3 mm (1/4") drive, external 10 mm (3/8"), max. capacity 60 Nm
- adaptor internal 10 mm (3/8") drive, external 6.3 mm (1/4"), max. capacity 60 Nm
- adaptor internal 10 mm (3/8") drive, external 12.5 mm (1/2"), max. capacity 200 Nm
- adaptor internal 12.5 mm (1/2") drive, external 10 mm (3/8"), max. capacity 200 Nm
- adaptor internal 12.5 mm (1/2") drive, external 20 mm (3/4"), max. capacity 500 Nm
- adaptor internal 20 mm (3/4") drive, external 12.5 mm (1/2"), max. capacity 500 Nm
- universal joint with spring 6.3 mm (1/4")
- universal joint with spring 10 mm (3/8")
- universal joint with spring 12.5 mm (1/2")
- surface finish: satin chrome plated (except for universal joints)
- width: 189 mm
- height: 32 mm
- depth: 408 mm



Item #	Description
4051	Tool Tray 1/3: Extension Bar, Adaptor and Joint Set 18 pcs.
4051-1	Tool Tray 1/3, empty for Item 4051

Tool Tray 1/3: Combination Spanner Set | 6 - 22 mm | 12 pcs.

- cold forged
- ring head 15° angled
- profile on ring side: 12-point
- 12 combination spanners 6 - 7 - 8 - 9 - 10 - 11 - 12 - 13 - 14 - 17 - 19 - 22 mm
- surface finish: satin chrome plated
- width: 189 mm
- height: 32 mm
- depth: 408 mm



Item #	Description
4082	Tool Tray 1/3: Combination Spanner Set 6 - 22 mm 12 pcs.
4082-1	Tool Tray 1/3, empty for Item 4082

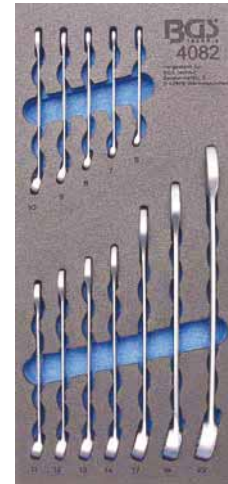

Tool Tray 1/3: Combination Spanner Set | 24 - 32 mm | 4 pcs.

- cold forged, ring end 15° offset
- profile on ring side: 12-point
- 4 combination spanners: 24 - 27 - 30 - 32 mm
- surface finish: chrome-plated, matt
- width: 189 mm
- height: 32 mm
- depth: 408 mm



Item #	Description
4083	Tool Tray 1/3: Combination Spanner Set 24 - 32 mm 4 pcs.
4083-1	Tool Tray 1/3, empty for Item 4083



Tool Tray 1/3: Double Open End Spanner Set | 6 - 22 mm | 8 pcs.

- cold forged
- 8 double open end spanners: 6 x 7 - 8 x 9 - 10 x 11 - 12 x 13 - 14 x 15 - 16 x 17 - 18 x 19 - 20 x 22
- surface finish: satin chrome plated
- width: 189 mm
- height: 32 mm
- depth: 408 mm



Item #	Description
4081	Tool Tray 1/3: Double Open End Spanner Set 6 - 22 mm 8 pcs.
4081-1	Tool Tray 1/3, empty for Item 4081

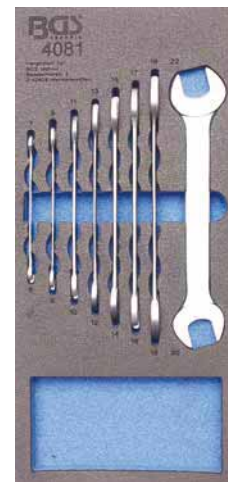

Tool Tray 1/3: Double Ring Spanner Set | 6x7 - 20x22 mm | deep offset Ends | 8 pcs.

- cold forged
- profile on ring side: 12-point
- 8 double ring spanners: 6 x 7 - 8 x 9 - 10 x 11 - 12 x 13 - 14 x 15 - 16 x 17 - 18 x 19 - 20 x 22 mm
- surface finish: satin chrome plated
- width: 189 mm
- height: 32 mm
- depth: 408 mm

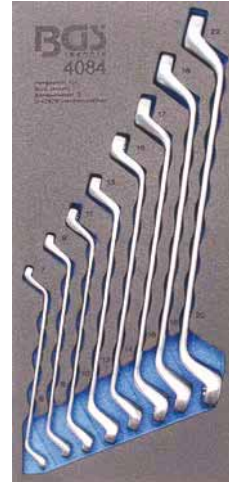

Item #	Description
4084	Tool Tray 1/3: Double Ring Spanner Set 6x7 - 20x22 mm deep offset Ends 8 pcs.
4084-1	Tool Tray 1/3, empty for Item 4084

Tool Tray 1/3: Ratchet Wrench Set | 8 - 19 mm | 12 pcs.

- fine toothed (72 tooth)
- 8 mm, length 130 mm
- 9 mm, length 140 mm
- 10 mm, length 155 mm
- 11 mm, length 160 mm
- 12 mm, length 165 mm
- 13 mm, length 170 mm
- 14 mm, length 185 mm
- 15 mm, length 200 mm
- 16 mm, length 205 mm
- 17 mm, length 220 mm
- 18 mm, length 230 mm
- 19 mm, length 245 mm
- surface finish: satin chrome plated
- width: 189 mm
- height: 32 mm
- depth: 408 mm



Item #	Description
4128	Tool Tray 1/3: Ratchet Wrench Set 8 - 19 mm 12 pcs.
4128-1	Tool Tray 1/3, empty for Item 4128

Tool Tray 1/3: Screwdriver T-Star (for Torx) | 5 pcs.

- non-slip rubber handles
- screwdriver, length: 80 mm, T-Star (for Torx) T6
- screwdriver, length: 80 mm, T-Star (for Torx) T7
- screwdriver, length: 80 mm, T-Star (for Torx) T8
- screwdriver, length: 80 mm, T-Star (for Torx) T9
- screwdriver, length: 80 mm, T-Star (for Torx) T10
- width: 189 mm
- height: 32 mm
- depth: 408 mm



Item #	Description
4076	Tool Tray 1/3: Screwdriver T-Star (for Torx) 5 pcs.
4076-1	Tool Tray 1/3, empty for Item 4076

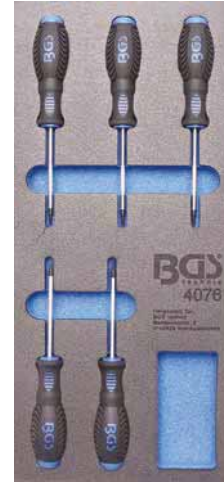

Tool Tray 1/3: Screwdriver T-Star (for Torx) | 6 pcs.

- non-slip rubber handle
- screwdriver, length: 80 mm, T-Star (for Torx) T15
- screwdriver, length: 80 mm, T-Star (for Torx) T20
- screwdriver, length: 100 mm, T-Star (for Torx) T25
- screwdriver, length: 100 mm, T-Star (for Torx) T27
- screwdriver, length: 100 mm, T-Star (for Torx) T30
- screwdriver, length: 150 mm, T-Star (for Torx) T40
- width: 189 mm
- height: 32 mm
- depth: 408 mm



Item #	Description
4078	Tool Tray 1/3: Screwdriver T-Star (for Torx) 6 pcs.
4078-1	Tool Tray 1/3, empty for Item 4078

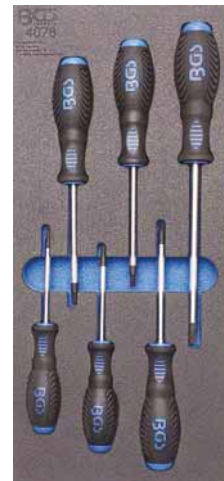

Workshop Trolley Tool Trays

Tool Tray 1/3: Screwdriver Set | 11 pcs.

- anti-slip 2-component handles
- screwdriver, 80 mm, cross slot PH1
- screwdriver, 100 mm, cross slot PH2
- screwdriver, 80 mm, slot SL 4 mm
- screwdriver, 125 mm, slot SL 5.5 mm
- screwdriver, 150 mm, slot SL 6.5 mm
- precision screwdriver, 75 mm, slot SL 2 mm
- precision screwdriver, 75 mm, slot SL 3 mm
- precision screwdriver, 75 mm, slot SL 4 mm
- precision screwdriver, 75 mm, cross slot PH00
- precision screwdriver, 75 mm, cross slot PH0
- precision screwdriver, 75 mm, cross slot PH1
- width: 189 mm
- height: 32 mm
- depth: 408 mm



Item #	Description
4131	Tool Tray 1/3: Screwdriver Set 11 pcs.
4131-1	Tool Tray 1/3, empty for Item 4131

Tool Tray 1/3: VDE Screwdriver Set | 8 pcs.

- anti-slip 2-component handles
- with hanging hole
- screwdriver, 75 mm, slot SL 0.5 x 3.0 mm
- screwdriver, 100 mm, slot SL 0.8 x 4.0 mm
- screwdriver, 125 mm, slot SL 1.0 x 5.5 mm
- screwdriver, 150 mm, slot SL 1.2 x 6.5 mm
- screwdriver, 75 mm, cross slot PH 0
- screwdriver, 80 mm, cross slot PH 1
- screwdriver, 100 mm, cross slot PH 2
- voltage tester, 140 mm, slot SL 0.5 x 3.0 mm
- width: 189 mm
- height: 32 mm
- depth: 408 mm



Item #	Description
4037	Tool Tray 1/3: VDE Screwdriver Set 8 pcs.
4037-1	Tool Tray 1/3, empty for Item 4037

Tool Tray 1/3: Precision Pliers Set "Mini" | 6 pcs.

- spring loaded
- 2-component handles
- combination pliers, 115 mm
- diagonal side cutters, 115 mm
- long nose pliers, 130 mm
- bent nose pliers, 125 mm
- end cutting pliers, 110 mm
- needle pliers, 150 mm
- width: 189 mm
- height: 32 mm
- depth: 408 mm



Item #	Description
4024	Tool Tray 1/3: Precision Pliers Set "Mini" 6 pcs.
4024-1	Tool Tray 1/3, empty for Item 4024



Tool Tray 1/3: VDE Pliers Set | 5 pcs.

- diagonal side cutters 160 mm
- cable stripper, 160 mm
- combination pliers 180 mm
- telephone pliers 200 mm
- telephone pliers, 200 mm, angled
- width: 189 mm
- height: 32 mm
- depth: 408 mm



Item #	Description
4132	Tool Tray 1/3: VDE Pliers Set 5 pcs.
4132-1	Tool Tray 1/3, empty for Item 4132



Tool Tray 1/3: Pliers Set | 3 pcs.

- diagonal side cutter, 165 mm
 - 2-component handles
- long nose pliers, straight, 200 mm
 - 2-component handles
- waterpump pliers with box joint, 240 mm, aperture max. 38 mm
 - forged, black finish
 - handles dip insulated
- surface finish: satin chrome plated
- width: 189 mm
- height: 32 mm
- depth: 408 mm



Item #	Description
4042	Tool Tray 1/3: Pliers Set 3 pcs.
4042-1	Tool Tray 1/3, empty for Item 4042

Tool Tray 1/3: Water Pump Pliers | 3 pcs.

- forged and hardened
- handles dip coated
- waterpump pliers 175 mm, aperture max. 27 mm
- waterpump pliers 240 mm, aperture max. 38 mm
- waterpump pliers 300 mm, aperture max. 44 mm
- width: 189 mm
- height: 32 mm
- depth: 408 mm

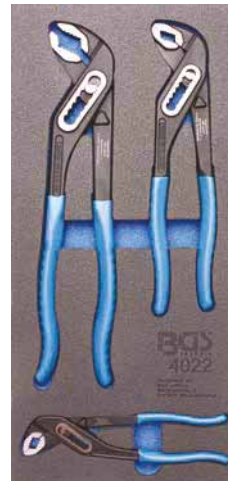

Item #	Description
4022	Tool Tray 1/3: Water Pump Pliers 3 pcs.
4022-1	Tool Tray 1/3, empty for Item 4022

Tool Tray 1/3: Circlip Pliers Set | 4 pcs.

- for the dismantling and assembly snap rings
- special hardened tips, Ø 1.8 mm
- dipped handles
- circlip pliers for external snap rings, 180 mm, angular
- circlip pliers for external snap rings, 180 mm, straight
- circlip pliers for internal snap rings, 180 mm, angular
- circlip pliers for internal snap rings, 180 mm, straight
- width: 189 mm
- height: 32 mm
- depth: 408 mm



Item #	Description
4025	Tool Tray 1/3: Circlip Pliers Set 4 pcs.
4025-1	Tool Tray 1/3, empty for Item 4025

Tool Tray 1/3: Locking Pliers | 4 pcs.

- adjustable contact pressure
- 3 locking pliers 125 - 180 - 250 mm
- 1 long nose pliers 150 mm
- width: 189 mm
- height: 32 mm
- depth: 408 mm



Item #	Description
4040	Tool Tray 1/3: Locking Pliers 4 pcs.
4040-1	Tool Tray 1/3, empty for Item 4040



Tool Tray 1/3: Stubby Bodywork Metal shears | 3 pcs.

- for cutting sheets made of stainless steel, steel, copper, brass, etc.
- cuts up to 1.2 mm cold rolled steel or 0.7 mm AISI-304 stainless steel
- serrated edged blades, forged, induction-hardened, chrome molybdenum alloy
- 2-component handles
- mini body sheet shears, 195 mm, straight cut
- mini body sheet shears, 195 mm, lefthand cut
- mini body sheet shears, 195 mm, righthand cut
- width: 189 mm
- height: 32 mm
- depth: 408 mm



Item #	Description
4125	Tool Tray 1/3: Stubby Bodywork Metal shears 3 pcs.
4125-1	Tool Tray 1/3, empty for Item 4125



Tool Tray 1/3: Metal Shears, Step Drill | 5 pcs.

- tinmans shears, cuts left + straight, 260 mm
- tooth jaw forged from chrome vanadium steel, right + straight cutting, 260 mm
- HSS step drill, titanium nitride, Ø 4 - 12 mm, steps: 4, 5, 6, 7, 8, 9, 10, 11, 12 mm
- HSS step drill, titanium nitride, Ø 4 - 20 mm, steps: 4, 6, 8, 10, 12, 14, 16, 18, 20 mm
- HSS step drill, titanium nitride, Ø 4 - 30 mm, steps: 4, 6, 8, 10, 12, 14, 16, 18, 20, 22, 24, 26, 28, 30 mm
- width: 189 mm
- height: 32 mm
- depth: 408 mm

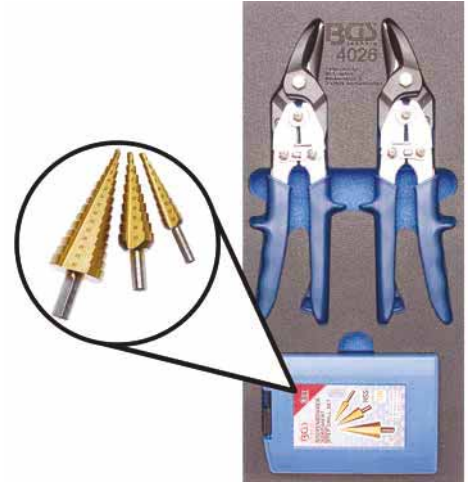

Item #	Description
4026	Tool Tray 1/3: Metal Shears, Step Drill 5 pcs.
4026-1	Tool Tray 1/3, empty for Item 4026

Tool Tray 1/3: Crimping Pliers Set with 5 Pairs of Pressing Jaws | 11 pcs.

- 1 crimping tool set with ratcheting function, adjustable jaws and pressure point unlocking
- 1 crimping jaws set for closed non-insulated terminal ends, AWG (20-18) - (16-14) - (12-10) - 8 or DIN 1.5 - 2.5 - 6 - 10 mm² or JIS 1.25 - 2 - 5.5 - 8 mm²
- 1 crimping jaws set for insulated terminal ends, AWG (22-18) - (16-14) - (12-10) or DIN (0.5-1.0) - (1.5-2.5) - (4-6) mm²
- 1 crimping jaws set for open, non-insulated terminal ends, AWG (20-18) - (16-14) - (12-10) or DIN (0.5-1.0) - (1.5-2.5) - (4-6) mm²
- 1 crimping jaws set for small insulated terminal ends, AWG (22-18) - (16-14) - (12-10) or DIN (0.5-1.0) - (1.5-2.5) - (4-6) mm²
- 1 crimping jaws set for big insulated terminal ends, AWG 22 - 20 - 18 - 16 - 14 - 12 or DIN 0.5 - 0.75 - 1.0 - 1.5 - 2.5 - 4.0 mm²
- width: 189 mm
- height: 32 mm
- depth: 408 mm



Item #	Description
4027	Tool Tray 1/3: Crimping Pliers Set with 5 Pairs of Pressing Jaws 11 pcs.
4027-1	Tool Tray 1/3, empty for Item 4027

Tool Tray 1/3: Crimping Tool and Wire Strippers | 12 pcs.

Crimping Tool Set with 5 Pairs of jaws

- 1 crimping tool set with ratcheting function, adjustable locking device and pressure point unlocking, exchangeable crimping jaws
- 1 crimping jaws set for closed non-insulated terminal ends, AWG (20-18) - (16-14) - (12-10) - 8, DIN 1.5 - 2.5 - 6 - 10 mm², JIS 1.25 - 2 - 5.5 - 8 mm²
- 1 crimping jaws set for insulated terminal ends, AWG (22-18) - (16-14) - (12-10), DIN (0.5-1.0) - (1.5-2.5) - (4-6) mm²
- 1 crimping jaws set for open, non-insulated terminal ends, AWG (22-18) - (16-14) - (12-10), DIN (0.5-1.0) - (1.5-2.5) - (4-6) mm²
- 1 crimping jaws set for small insulated terminal ends, AWG (22-18) - (16-14) - (12-10), DIN (0.5-1.0) - (1.5-2.5) - (4-6) mm²
- 1 crimping jaws set for big insulated terminal ends, AWG 22 - 20 - 18 - 16 - 14 - 12, DIN 0.5 - 0.75 - 1.0 - 1.5 - 2.5 - 4.0 mm²

Automatic wire stripper, 210 mm

- for wires with diameters 0.13 - 6 mm²
- with cutter for insulated, not insulated terminals and spark plug

- width: 189 mm
- height: 32 mm
- depth: 408 mm



Item #	Description
4029	Tool Tray 1/3: Crimping Tool and Wire Strippers 12 pcs.
4029-1	Tool Tray 1/3, empty for Item 4029

Tool Tray 1/3: File Set | 5 pcs.

- files with plastic handles
- 1 flat file, 250 mm, 1st cut (coarse)
- 1 flat file, 200 mm, 2nd cut (medium fine)
- 1 half-round file, 200 mm, 1st cut (coarse)
- 1 triangular file, 150 mm, 2nd cut (medium fine)
- 1 round file, 150 mm, 1st cut (coarse)
- width: 189 mm
- height: 32 mm
- depth: 408 mm



Item #	Description
4030	Tool Tray 1/3: File Set 5 pcs.
4030-1	Tool Tray 1/3, empty for Item 4030

Tool Tray 1/3: Wire Stripping Pliers | 3 pcs.

- 1 wire stripper
 - self-adjusting for cable diameter \varnothing 0.2 - 6 mm²
 - front-cutting with adjustable length stop for stripping from 8 to 12 mm
 - with cable cutter up to \varnothing 2 mm
 - locking device for spacesaving and protecting saw blades
- 1 wire stripper, 215 mm
 - for stripping cables \varnothing 0.5 - 0.65 - 0.8 - 1.0 - 1.3 - 1.6 - 2.0 mm, 12 - 14 - 16 - 18 - 20 - 22 - 24 AWG, coaxial cables 6 mm
 - for crimping non-insulated terminals: \varnothing 0.3 - 0.5 - 1.25 - 2.0 mm
 - specially hardened carbon steel
- 1 automatic wire stripper, 210 mm
 - for wires with diameters 0.13 - 6 mm²
 - with cutter for insulated and not insulated terminals and spark plugs
- width: 189 mm
- height: 32 mm
- depth: 408 mm



Item #	Description
4028	Tool Tray 1/3: Wire Stripping Pliers 3 pcs.
4028-1	Tool Tray 1/3, empty for Item 4028

Tool Tray 1/3: Bent Hose Clamp Pliers and Closure Clamps | 7 pcs.

- 3 hose clamping pliers
 - for clamping rubber hoses, e.g. brake, fuel and coolant hoses
 - approx. 30° angled
 - suitable for tube \varnothing 10 - 15 - 24 mm
 - fibre glass composite material
- 4-piece steel line stopper set
 - for closing brake, fuel and other automotive steel pipes
 - fits on e.g. 3/8", 5/16" and 1/2" banjo fittings
 - distance of sealing rubber is adjustable
 - prevents fluid leaks and contamination during service
 - suitable for all automotive fluids
- width: 189 mm
- height: 32 mm
- depth: 408 mm



Item #	Description
4123	Tool Tray 1/3: Bent Hose Clamp Pliers and Closure Clamps 7 pcs.
4123-1	Tool Tray 1/3, empty for Item 4123

Tool Tray 1/3: Oil Pan Sockets / Oil Filter Chain Wrench | 22 pcs.

10  3/8

Professional Oil Filter Chain Wrench

- pro version with duplex chain
- chain width 13 mm
- for rusted oil filter
- easy handling
- suitable for all steel filter cartridges with diameter 60 - 115 mm

Special Oil Pan Sockets, internal hexagon drive, 10 mm (3/8"), 21 pcs.

- black finish
- 9 hexagon sockets 8 - 9 - 10 - 12 - 14 - 17 mm, 5/16", 10 mm (3/8"), 12.5 mm (1/2")
- 8 square sockets 8 - 11 - 12 - 13 - 14 mm, 5/16", 10 mm (3/8"), 12.5 mm (1/2")
- 1 internal square socket 10 mm
- 1 triangle socket 10 mm
- 1 spline socket M16
- 1 sliding T-bar, 200 mm

- width: 189 mm
- height: 32 mm
- depth: 408 mm



Item #	Description
4094	Tool Tray 1/3: Oil Pan Sockets / Oil Filter Chain Wrench 22 pcs.
4094-1	Tool Tray 1/3, empty for Item 4094

Tool Tray 1/3: Flare Nut Wrench and Special Socket | 10 mm (3/8") | 13 pcs.

- 6 open end ring spanners, satin chrome plated: 8 x 10 - 9 x 11 - 12 x 13 - 14 x 15 - 16 x 18 - 17 x 19 mm
- 1 special flare nut wrench with reinforced hexagon ends, double cranked, length: 175 mm, satin chrome plated: 10 x 11 mm
- 6 special sockets, internal square 10 mm (3/8"), slotted: 10 mm (slot 7.4 mm) - 11 mm (slot 8.8 mm) - 12 mm (slot 9.1 mm) - 14 mm (slot 10.5 mm) - 17 mm (slot 13.3 mm) - 19 mm (slot 14.4 mm)
 - for the assembly of top and side wired temperature sensors, thermo switches and other components
 - also suitable for nuts and bolts on bent pipes
- surface finish: satin chrome plated
- width: 189 mm
- height: 32 mm
- depth: 408 mm



Item #	Description
4048	Tool Tray 1/3: Flare Nut Wrench and Special Socket 10 mm (3/8") 13 pcs.
4048-1	Tool Tray 1/3, empty for Item 4048

Workshop Trolley Tool Trays

Tool Tray 1/3: Measuring Tool Set | 7 pcs.

- 1 digital vernier caliper with digital display, 150 mm, scale in mm/inch, reading 1/100 mm, zero reset in any position, metric/inch conversion, + / - display, incl. battery
- 1 precision feeler gauges, 20 blades, 100 mm long, 0.05 - 1.0 mm
- 1 contour gauge, pin type, length: 125 mm
- 1 measuring tape, 19 mm x 5 m, with locking function and belt clip, in accordance with EEC
- 1 scribe, 150 mm, carbide metal tip
- 1 digital tire depth gauge, 0 - 28 mm, measuring range up to 28 mm, mm / inch display, battery included
- 1 brake disc caliper, for measuring the brake disc thickness, tire tread depth etc., max. measuring depth: 60 mm, dimensions: 182 x 115 x 13 mm
- width: 189 mm
- height: 32 mm
- depth: 408 mm



Item #	Description
4031	Tool Tray 1/3: Measuring Tool Set 7 pcs.
4031-1	Tool Tray 1/3, empty for Item 4031

Tool Tray 1/3: Crowfoot Spanner and Flare Nut Wrench Set | 15 pcs.

- 2 ratchet wrenches, chrome vanadium steel, 10 + 11 mm, slotted 12-point rotating core for pipe fittings, non-slip handle
 - 1 brake pipe wrench, 10 x 11 mm
 - ring ends with ratcheting function
 - both sides flexible
 - rings can be opened to fit around a pipe
 - an internal spring ensures the ring closes securely around the nut
 - the more pressure you put on the tools in the driving direction, the tighter the head closes around the nut, this prevents slipping over the nut
 - wrench holds the long sides of the nut and not its corners, therefore it works also on nuts with damaged corners
 - 10 crowfoot spanners, satin chrome plated, internal square drive 10 mm (3/8"), 10 - 11 - 12 - 13 - 14 - 15 - 16 - 17 - 18 - 19 mm
 - 1 drive adaptor, satin chrome plated, 10 mm (3/8") x 12.5 mm (1/2") drive
 - 1 extension bar, satin chrome plated, 10 mm (3/8"), length: 150 mm
- surface finish: satin chrome plated
 - width: 189 mm
 - height: 32 mm
 - depth: 408 mm



Item #	Description
4049	Tool Tray 1/3: Crowfoot Spanner and Flare Nut Wrench Set 15 pcs.
4049-1	Tool Tray 1/3, empty for Item 4049

Tool Tray 1/3: Stoning and Machinist's Hammer Set | 2 pcs.

- forged, black lacquered head
- fibreglass
- rubber coated handle
- stoning hammer, 1000 g
- machinist's hammer, 300 g
- width: 189 mm
- height: 32 mm
- depth: 408 mm



Item #	Description
4046	Tool Tray 1/3: Stoning and Machinist's Hammer Set 2 pcs.
4046-1	Tool Tray 1/3, empty for Item 4046



Tool Tray 1/3: Hammer and Chisel Set | 14 pcs.

- **hammer with interchangeable heads, Ø 35 mm**
 - 5 interchangeable heads, diameter approx. 35 mm, made from copper, aluminium, plastic, nylon, steel
 - overall length: 305 mm
 - hickory handle
- **machinist's hammer**
 - hickory handle
 - manufactured in accordance with DIN 1041
 - weight: 300 g
- **corner pin drive, chisel and punch set**
 - hardened hexagonal shaft
 - pin punches: 3-4-5-6-8 mm
 - 1 flat chisel 15mm
 - 1 cross-cut chisel 4mm
 - 1 center punch
 - length 150 mm
- width: 189 mm
- height: 32 mm
- depth: 408 mm



Item #	Description
4129	Tool Tray 1/3: Hammer and Chisel Set 14 pcs.
4129-1	Tool Tray 1/3, empty for Item 4129



Tool Tray 1/3: Tyre Repair Kit | 54 pcs.

- 50 tire radial inserts, length: 102 mm
- 1 mounting paste for tire radial inserts
- 1 stitch awl
- 1 inserts installing tool
- 1 safety cutter
- width: 189 mm
- height: 32 mm
- depth: 408 mm

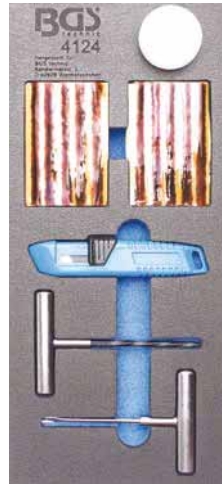

Item #	Description
4124	Tool Tray 1/3: Tyre Repair Kit 54 pcs.
4124-1	Tool Tray 1/3, empty for Item 4124

Tool Tray 1/3: Handheld Lamp and Magnetic Lifter | 3 pcs.

- COB LED working light with the newest light strip technology for bright light
- adjustable in 9 positions by 180° magnetic feet
- 2 magnets on the back side
- 2 folding hooks
- LED type: 3 W COB LED brightness: 250 LM
- working time: approx. 2.5 hours, IP20 waterproofed
- battery: rechargeable Lithium 3.7 V / 2000 mAh
- magnetic lifter with LED, 600 mm, up to 1500 g, strong LED lamp on magnetic tip
- width: 189 mm
- height: 32 mm
- depth: 408 mm



Item #	Description
4032	Tool Tray 1/3: Handheld Lamp and Magnetic Lifter 3 pcs.
4032-1	Tool Tray 1/3, empty for Item 4032

Tool Tray 1/3: Hole Punch Set | 15 pcs.

- 13 interchangeable hole punches 5 - 6 - 8 - 10 - 11 - 13 - 16 - 19 - 22 - 25 - 28 - 32 - 35 mm
- 1 quick change punch holder with ergonomic handle design and spring-mounted centre punch, suitable for paper, plastic film and rubber, ideal for punching paper seals
- 1 machinist's hammer, 400 g, shock-resistant handle, protection metal sleeve, safety pin, round ring wedge, forged hammer head, made in accordance with DIN 1041
- width: 189 mm
- height: 32 mm
- depth: 408 mm



Item #	Description
4041	Tool Tray 1/3: Hole Punch Set 15 pcs.
4041-1	Tool Tray 1/3, empty for Item 4041



Tool Tray 1/3: Knife and Shears Set | 6 pcs.

includes the following tools:

- 1 universal shears, 180 mm
- 1 electrician's scissors, 145 mm
 - heavy-duty stainless steel blades
 - 2 component handle with soft grips for comfort with spring and security lock
 - one saw-type blade
 - with wire stripping gap
- 1 folding knife, 145 mm
 - material: aluminium, anodised
 - for cutting carpet, cardboard, foils, etc.
 - locking mechanism for locking the knife in open state and unlocking mechanism at the back of the handle for folding the knife
 - blade locking mechanism with quick release function
- 1 safety cutter, heavy duty
 - safety auto retracting mechanism
 - metal guide
 - compartment for spare blades in handle
- 5 trapezoidal blades for safety cutter / folding knife, 12 mm
- 10 spare blades for Snap-off knives (not contained in tray) , 18 mm

- width: 189 mm
- height: 32 mm
- depth: 408 mm



Item #	Description
4096	Tool Tray 1/3: Knife and Shears Set 6 pcs.
4096-1	Tool Tray 1/3, empty for Item 4096



Tool Tray 1/3: Brush Assortment | 20 pcs.

- for polishing and cleaning machines, cars and other work pieces made of metal, plastic, wood, etc.
- 18 brushes, external square 6.3 mm (1/4"): Ø 9 - 11 - 13 - 15 - 17 - 19 mm (6 brass, 6 nylon, 6 stainless steel)
- 1 extension with quick release for power tool use, 6.3 mm (1/4"), 150 mm long
- 1 grip handle with quick release for hand use, 6.3 mm (1/4"), 150 mm long
- width: 189 mm
- height: 32 mm
- depth: 408 mm

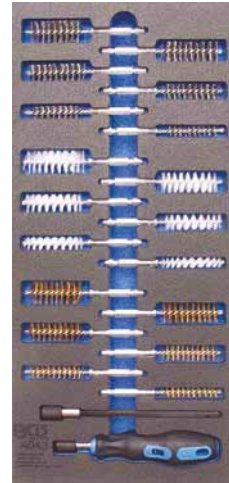

Item #	Description
4043	Tool Tray 1/3: Brush Assortment 20 pcs.
4043-1	Tool Tray 1/3, empty for Item 4043

Tool Tray 1/3: Engine Timing Tool Set | for BMW S65

- for adjusting the engine timing, when replacing the timing chain, cylinder head gasket, etc.
- suitable for following models with S65 engines: BMW M3 E90 / E92 / E93 (>2007) Wiesmann MF4 (>2009)
- camshaft adjusting tool (inlet), to be used as OEM 11 9 971
- camshaft adjusting tool (exhaust), to be used as OEM 11 9 972
- crankshaft locking tool, to be used as OEM 11 5 320
- VANOS adjusting tool, to be used as OEM 11 5 370
- chain tensioner locking tool, to be used as OEM 11 5 290
- 6 mounting screws for camshaft adjusting tools



Tool Tray 1/3, empty: 3 Storage Compartments | 408 x 189 x 32 mm

- tool tray made from high-resistance foam
- dimensions: 189 x 408 x 32 mm
- width: 189 mm
- height: 32 mm
- depth: 408 mm



Item #
4091

Tool Tray 1/3: Storage Tray with Magnetic Bottom Plate | 129 x 348 x 14 mm

- for antislip and lossless storing of smaller tools and metal parts
- width: 189 mm
- height: 32 mm
- depth: 408 mm



Item #		
9275		

Tool Tray 2/3: Socket Set 12.5 mm (1/2 ") | 27 pcs.

12.5  1/2

- sockets in hexagon Pro torque® design
- 1 reversible ratchet , 72 teeth, 12.5 mm (1/2") drive
- 2 "wobble" extension bars, 12.5 mm (1/2") drive: 125 + 250 mm
- 1 adapter for extension bar, sliding bar
- 1 universal joint, 12.5 mm (1/2") drive:
- 2 spark plug sockets: 16 + 21 mm
- 20 Pro torque® sockets, 12.5 mm (1/2") drive: 8 - 9 - 10 - 11 - 12 - 13 - 14 - 15 - 16 - 17 - 18 - 19 - 20 - 21 - 22 - 23 - 24 - 27 - 30 - 32 mm
- width: 378 mm
- height: 32 mm
- depth: 408 mm



CV		
----	---	---

Item #	Description
4053	Tool Tray 2/3: Socket Set 12.5 mm (1/2 ") 27 pcs.
4053-1	Tool Tray 2/3, empty for Item 4053

Tool Tray 2/3: Ratchet Wrenches | 90° adjustable | 8 - 19 mm | 12 pcs.

- 72 tooth
- flexible heads 90° adjustable
- 12 ratchet wrenches: 8 - 9 - 10 - 11 - 12 - 13 - 14 - 15 - 16 - 17 - 18 - 19 mm
- width: 378 mm
- height: 32 mm
- depth: 408 mm



CV		
----	---	---

Item #	Description
4077	Tool Tray 2/3: Ratchet Wrenches 90° adjustable 8 - 19 mm 12 pcs.
4077-1	Tool Tray 2/3, empty for Item 4077

Tool Tray 2/3: Cross and Slot Screwdrivers | 8 pcs.

- anti-slip 2-component handles
- with 6.3 mm (1/4") socket square in handle
- screwdriver, 75 mm, slot SL 5 mm
- screwdriver, 100 mm, slot SL 6 mm
- screwdriver, 150 mm, slot SL 8 mm
- screwdriver, 200 mm, slot SL 10 mm
- screwdriver, 75 mm, cross slot PH1
- screwdriver, 100 mm, cross slot PH2
- screwdriver, 150 mm, cross slot PH3
- screwdriver, 200 mm, cross slot PH4
- width: 378 mm
- height: 32 mm
- depth: 408 mm



Item #	Description
4055	Tool Tray 2/3: Cross and Slot Screwdrivers 8 pcs.
4055-1	Tool Tray 2/3, empty for Item 4055

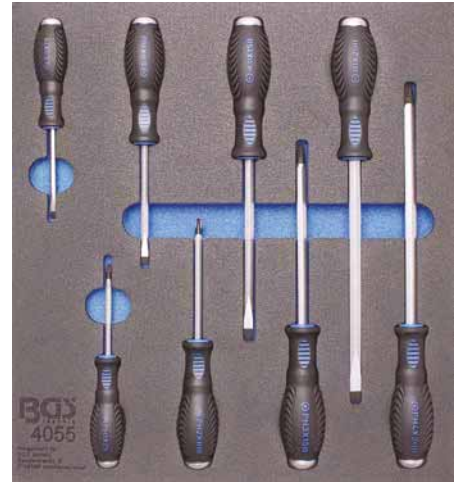

Tool Tray 2/3: Screwdriver Set | T-Star (for Torx) T6 - T40 | 11 pcs.

- anti-slip 2-component handles
- screwdrivers, 80 mm, T-Star (for Torx): T6 - T7 - T8 - T9 - T10 - T15 - T20 - T25
- screwdrivers, 100 mm, T-Star (for Torx): T27 - T30
- screwdriver, 150 mm, T-Star (for Torx): T40
- width: 378 mm
- height: 32 mm
- depth: 408 mm



Item #	Description
4079	Tool Tray 2/3: Screwdriver Set T-Star (for Torx) T6 - T40 11 pcs.
4079-1	Tool Tray 2/3, empty for Item 4079



Tool Tray 2/3: 12-piece Screwdriver Set

- end-to-end blades with external hexagon (except slot SL 3.0 mm and PH 0)
- ergonomically designed 2-component handles
- length without handle and hexagon
- screwdriver, 75 mm, slot SL: 3.0 mm
- screwdriver, 75 mm, slot SL: 5.0 mm
- screwdriver, 38 mm, slot SL 6.0 mm
- screwdriver, 100 mm, slot SL 6.0 mm
- screwdriver, 150 mm, slot SL 8.0 mm
- screwdriver, 200 mm, slot SL 9.5 mm
- screwdriver, 75 mm, cross slot PH0
- screwdriver, 75 mm, cross slot PH1
- screwdriver, 100 mm, cross slot PH2
- screwdriver, 38 mm, cross slot PH2
- screwdriver, 150 mm, cross slot PH3
- screwdriver, 200 mm, cross slot PH4
- width: 378 mm
- height: 32 mm
- depth: 408 mm



Item #	Description
4122	Tool Tray 2/3: 12-piece Screwdriver Set
4122-1	Tool Tray 2/3, empty for Item 4122



Tool Tray 2/3: Pliers Set | 7 pcs.

- all pliers with solid 2-component soft grip handles
- waterpump pliers with box joint, 240 mm, with safety grip and PVC dipped handles
- diagonal side cutters, 165 mm
- bent nose pliers, 200 mm
- combination pliers, 175 mm
- long nose pliers, straight, 160 mm
- end cutting pliers, 165 mm
- cable stripper, 150 mm
- surface finish: satin chrome plated
- width: 378 mm
- height: 32 mm
- depth: 408 mm



Item #	Description
4133	Tool Tray 2/3: Pliers Set 7 pcs.
4133-1	Tool Tray 2/3, empty for Item 4133



Tool Tray 2/3: Centre Punches, Chisels, Pin Punches | 14 pcs.

- automatic centre punch
 - heavy duty finish
 - continuously adjustable 15 - 25 kg
- panel chisel, 26 x 235 mm
 - with extra thin chisel and handle with rubber protection
 - tip can be sharpened
- parallel pin punch set, chisel and center punch, 12 pcs.
 - heavy duty type with hexagon shaft
 - forged carbon steel
 - 6 different flat chisels: 14.5 mm x 145 mm to 19 mm x 250 mm
 - 3 pin punches: 4.5 x 250 mm - 6.5 x 180 mm - 8 x 250 mm
 - 2 punches: 150 mm - 200 mm
 - 1 drift punch 9.7 x 200 mm
- width: 378 mm
- height: 32 mm
- depth: 408 mm



Item #	Description
4045	Tool Tray 2/3: Centre Punches, Chisels, Pin Punches 14 pcs.
4045-1	Tool Tray 2/3, empty for Item 4045

Tool Tray 2/3: Brake Piston Wind Back Set | 50 pcs.

- for rewinding the brake piston e.g. when replacing the brake pads
- wind-back spindle (clockwise)
- wind-back spindle (counterclockwise)
- pin punches, Ø 5.4 mm
- pin punches, Ø 6 mm, with 3 mm pin
- 6 mm L-type hexagon wrench
- 8 mm L-type hexagon wrench
- impact socket, 6-point, 12.5 mm (1/2"), 19 mm
- impact socket, 6-point, 12.5 mm (1/2"), 14 mm
- bit socket, 12.5 mm (1/2"), 10 mm
- T-Star bit socket (for Torx), 10 mm (3/8"), T45
- 4 counterholding plates
- 35 wind-back adaptors, suitable for most models like BMW, VW, Skoda, Seat, Ford, Honda, Alfa Romeo, Suzuki, Nissan, Toyota, etc.
- width: 378 mm
- height: 32 mm
- depth: 408 mm



Item #	
1102	

Tool Tray 3/3: Socket Set | 80 pcs.

6.3  1/4 10  3/8 12.5  1/2

- reversible ratchets, fine 72 tooth, quick-release button, anti-slip 2-component handles, 6.3 mm (1/4") - 10 mm (3/8") - 12.5 mm (1/2")
- Pro Torque® sockets, 6.3 mm (1/4") drive: 4 - 4.5 - 5 - 5.5 - 6 - 7 - 8 - 9 - 10 - 11 - 12 - 13 - 14 mm
- Pro Torque® sockets, 10 mm (3/8") drive: 10 - 11 - 12 - 13 - 14 - 15 - 16 - 17 - 18 - 19 mm
- Pro Torque® sockets, 12.5 mm (1/2") drive: 10 - 11 - 12 - 13 - 14 - 15 - 16 - 17 - 18 - 19 - 20 - 21 - 22 - 24 - 27 - 30 - 32 mm
- Pro Torque® deep sockets, 6.3 mm (1/4") drive: 4 - 5 - 5.5 - 6 - 7 - 8 - 9 - 10 - 11 - 12 - 13 mm
- Pro Torque® deep sockets, 10 mm (3/8") drive: sizes: 8 - 10 - 11 - 12 - 13 - 14 - 15 - 16 - 17 - 18 - 19 mm
- Pro Torque® deep sockets, 12.5 mm (1/2") drive: 10 - 13 - 15 - 16 - 17 - 18 - 19 - 22 - 24 mm
- Extension bar external, 6.3 mm (1/4") drive, length: 75 mm
- Extension bar external, 10 mm (3/8") drive, length: 150 mm
- Extension bar external, 12.5 mm (1/2") drive, length: 125 mm
- Universal joint external/internal square: 6.3 mm (1/4") - 10 mm (3/8") - 12.5 mm (1/2")
- surface finish: satin chrome plated
- width: 567 mm
- height: 32 mm
- depth: 408 mm

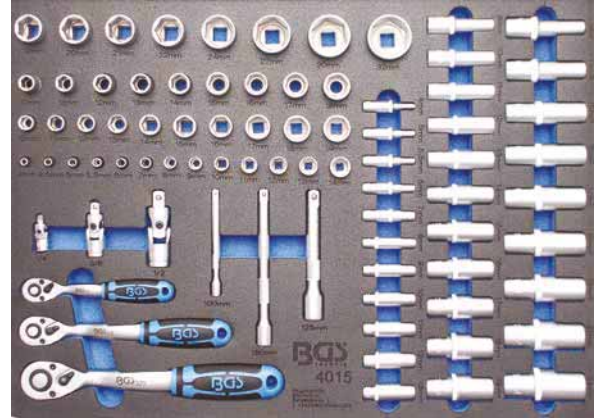

Workshop Trolley Tool Trays



Item #	Description
4015	Tool Tray 3/3: Socket Set 80 pcs.
4015-5	Tool Tray 3/3, empty for Item 4015

Tool Tray 3/3: Socket Set | 192 pcs.

6.3  1/4 | 10  3/8 | 12.5  1/2

- Sockets in hexagon Pro torque® design
- fine-toothed ratchet, 72 teeth

includes the following tools:

with 6.3 mm (1/4") drive:

- reversible ratchet, sliding bar, handle 150 mm
- extension bar 50 and 100 mm, universal joint
- 13 sockets: 4 - 14 mm
- 7 deep sockets: 4 - 10 mm
- 5 E-type sockets: E4 - E8
- 1 bit holder for 6.3 mm (1/4") bits
- 3 cross slot bit sockets: PH0 - PH1 - PH2
- 3 PZ cross slot bit sockets: PZ0 - PZ1 - PZ2
- 4 slotted bit sockets: 4 - 7 mm
- 4 internal hexagon bit sockets: 3 - 6 mm
- 8 T-Star bit sockets (for Torx): T8 - T30
- 8 bit sockets, T-Star tamperproof (for Torx): T8 - T30

with 10 mm (3/8") drive:

- reversible ratchet
- extension bar 125 mm, universal joint
- 1 glow plug socket 18 mm
- 10 sockets: 10 - 19 mm
- 6 deep sockets: 10 - 15 mm
- 5 E-type sockets: E10 - E16
- 1 bit holder for 8 mm bits

with 12.5 mm (1/2") drive:

- reversible ratchet
- extension bar 125 and 250 mm, universal joint, 1 sliding bar adaptor for 12.5 mm (1/2") extension bar
- 1 bit holder for 8 mm bits
- 2 glow plug sockets: 16 mm - 21 mm
- 17 sockets: 10 - 32 mm
- 5 deep sockets: 16 - 22 mm
- 3 E-type sockets: E18 - E20 - E24

bits with 8 mm drive:

- 3 slot: SL 8 - 10 - 12 mm
- 4 cross slot: PH3 - PH4 - PZ3 - PZ4
- 5 internal hexagon: 7 - 8 - 10 - 12 - 14 mm
- 6 T-Star (for Torx): T40 - T70
- 6 T-Star tamperproof (for Torx): T40 - T70

bits with 6.3 mm (1/4") drive

- 10 T-Star (for Torx): T5 - T40
- 8 T-Star tamperproof (for Torx): T7 - T40
- 5 spline (for Ribe): M5 - M9
- 3 spline (for XZN): M5 - M6 - M8
- 8 TS-Star (for Torx Plus): TS10 - TS45
- 2 cross slot: PH3 - PH4
- 2 cross slots PZ3 - PZ4
- 2 internal hexagon: H2 - H2.5
- 7 internal hexagon L-type keys: 1 - 5 mm



Item #	Description
4036	Tool Tray 3/3: Socket Set 192 pcs.
4036-1	Tool Tray 3/3, empty for Item 4036

Tool Tray 3/3: Bit and Bit Socket | 104 pcs.

6.3  1/4 12.5  1/2

Bits 8 mm (5/16"), length 30 mm:

- slot: 8 - 10 - 12 mm
- cross slot PH: PH3 - PH4
- cross slot PZ: PZ3 - PZ4
- T-Star (for Torx): T40 - T45 - T50 - T55 - T60 - T70
- T-Star tamperproof (for Torx): T40 - T45 - T50 - T55 - T60 - T70
- internal hexagon: 7 - 8 - 10 - 12 - 14 mm
- bit adaptor hexagon 6.3 mm (1/4) to hexagon 8 mm (5/16")

Bit Sockets, 6.3 mm (1/4") drive, length 35 mm:

- slot: 4 - 5.5 - 6.5 - 7 mm
- cross slot PH: PH0 - PH1 - PH2 - PH3
- Cross slot PZ: PZ0 - PZ1 - PZ2 - PZ3
- T-Star (for Torx): T8 - T9 - T10 - T15 - T20 - T25 - T27 - T30 - T40
- T-Star tamperproof (for Torx): T8 - T9 - T10 - T15 - T20 - T25 - T27 - T30 - T40
- Spline (for XZN): M8 - M10 - M12
- internal hexagon: 3 - 4 - 5 - 6 - 7 - 8 mm
- TS-Star: TS10 - TS15 - TS20 - TS25 - TS27 - TS30 - TS40 - TS45 - TS50

Bit Sockets, drive 12.5 mm (1/2") drive:

- length 55 mm, internal hexagon: 14 - 17 - 19 - 22 - 24 mm
- length 140 mm, internal hexagon: 10 - 11 - 13 mm
- length 140 mm, Spline (for XZN): M10 - M12 - M14
- length 240 mm, Spline (for Ribe): R7 -R8
- length 140 mm, T-Star (for Torx): T40 - T45 - T50 - T55 - T60 - T70

Special Sizes, 12.5 mm (1/2") drive

- Spline (for XZN) M9 x 100 mm - M16 x 100 mm
- Spline tamperproof (for XZN) M16 x 53 mm
- impact bit socket spline (for XZN) M18 x 78 mm
- T-Star (for Torx) T80 x 100 mm - T30 x 300 mm
- internal hexagon 7 x 230 mm
- inner hexagon ball point, 5 x 160 mm
- Spline (for Ribe) R9 x 100 mm - R10 x 140 mm

- width: 567 mm
- height: 32 mm
- depth: 408 mm

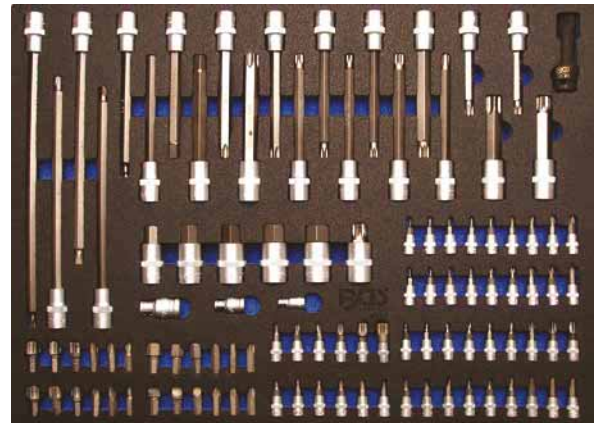

Workshop Trolley Tool Trays



Item #	Description
4017	Tool Tray 3/3: Bit and Bit Socket 104 pcs.
4017-5	Tool Tray 3/3, empty for Item 4017

Tool Tray 3/3: Hammer, Pliers, Screwdriver Set | 36 pcs.

- machinist's hammer, black lacquered head, fibreglass shaft, 300 g
- L-type keys, extra long model, in folding holder, T-Star (for Torx): T10 - T15 - T20 - T25 - T27 - T30 - T40 - T45 - T50
- L-type keys, extra long model, in folding holder, internal hexagon, long side with ball head: 1.5 - 2.0 - 2.5 - 3.0 - 4.0 - 5.0 - 6.0 - 8.0 - 10 mm
- cotter pin drive, 150 mm, hardened, lacquered shaft: 3 - 4 - 5 - 6 - 7 - 8 mm
- centre punch, 120 mm, hardened, lacquered shaft: 5 x 12 mm
- workshop screwdriver, 2-component handles, slot drive: 3 x 60 mm - 4 x 80 mm - 5.5 x 125 mm - 6.5 x 150 mm
- workshop screwdriver, 2-component handles, cross slot PH: PH1 x 80 mm - PH2 x 100 mm - PH3 x 150 mm
- long nose pliers, straight, 200 mm / side cutter, 165 mm
 - with strong 2 component hand protection insulation
- waterpump pliers with box-joint, 240 mm
 - safety handles
 - forged, hardened
 - painted black
 - polished jaws and joint
 - Handle dip insulated
 - aperture max. 38 mm
- surface finish: satin chrome plated
- width: 567 mm
- height: 32 mm
- depth: 408 mm



Item #	Description
4038	Tool Tray 3/3: Hammer, Pliers, Screwdriver Set 36 pcs.
4038-1	Tool Tray 3/3, empty for Item 4038

Tool Tray 3/3: Combination Spanners and E-Type Spanners Assortment | 22 pcs.

- cold forged
- offset ring ends
- combination spanners: 8 - 9 - 10 - 11 - 12 - 13 - 14 - 15 - 16 - 17 - 18 - 19 - 21 - 22 - 24 - 27 - 30 - 32 mm
- E-type spanner E6 x E8 - E10 x E12 - E14 x E18 - E20 x E24
- surface finish: satin chrome plated
- width: 567 mm
- height: 32 mm
- depth: 408 mm

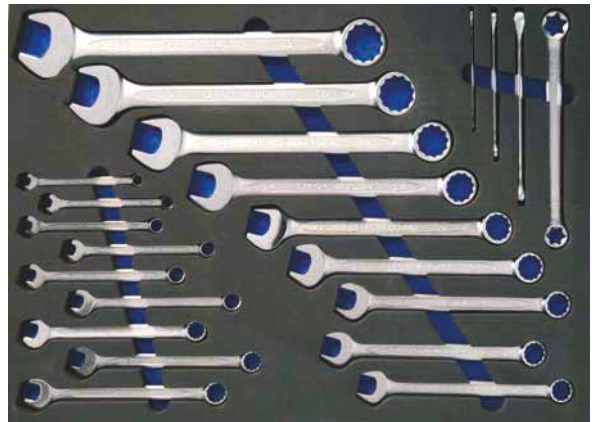

Item #	Description
4012	Tool Tray 3/3: Combination Spanners and E-Type Spanners Assortment 22 pcs.
4012-5	Tool Tray 3/3, empty for Item 4012

Tool Tray 3/3: Open End / Ring Spanners | 35 pcs.

- cold forged
- offset ring end
- 8 double open end spanners: 6 x 7 - 8 x 9 - 10 x 11 - 12 x 13 - 14 x 15 - 16 x 17 - 18 x 19 - 20 x 22 mm
- 17 combination spanners: 6 - 7 - 8 - 9 - 10 - 11 - 12 - 13 - 14 - 15 - 16 - 17 - 18 - 19 - 22 - 24 - 27 mm
- 10 double ring spanners, deep offset ends: 6 x 7 - 8 x 9 - 10 x 11 - 12 x 13 - 14 x 15 - 16 x 17 - 18 x 19 - 20 x 22 - 21 x 23 - 24 x 27 mm
- surface finish: satin chrome plated
- width: 567 mm
- height: 32 mm
- depth: 408 mm

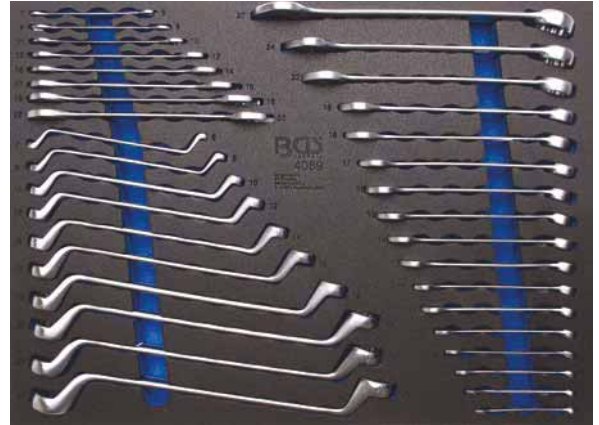

Item #	Description
4089	Tool Tray 3/3: Open End / Ring Spanners 35 pcs.
4089-1	Tool Tray 3/3, empty for Item 4089

Tool Tray 3/3: Spanners / Ratchet Wrenches | 26 pcs.

- cold forged
- offset ring end
- double open end spanners: 6 x 7 - 8 x 9 - 10 x 11 - 12 x 13 - 14 x 15 - 16 x 17 - 18 x 19 - 20 x 22 mm
- double ring spanners, deep offset ends: 6 x 7 - 8 x 9 - 10 x 11 - 12 x 13 - 14 x 15 - 16 x 17 - 18 x 19 - 20 x 22 mm
- ratchet ring spanners, stubby type, reversible, fine 72-tooth: 10 - 11 - 12 - 13 - 14 - 15 - 16 - 17 - 18 - 19 mm
- surface finish: satin chrome plated
- width: 567 mm
- height: 32 mm
- depth: 408 mm



Item #	Description
4016	Tool Tray 3/3: Spanners / Ratchet Wrenches 26 pcs.
4016-5	Tool Tray 3/3, empty for Item 4016

Tool Tray 3/3: T-Handle Universal Joint Socket Set | 8 - 19 mm | 11 pcs.

- sliding bar width: 200 mm
- T-handle universal joint socket with sliding bar, length: 340 mm: 8 - 10 - 11 - 12 - 13 - 14 - 15 - 16 - 17 - 18 - 19 mm
- length: 340 mm
- width: 567 mm
- height: 32 mm
- depth: 408 mm

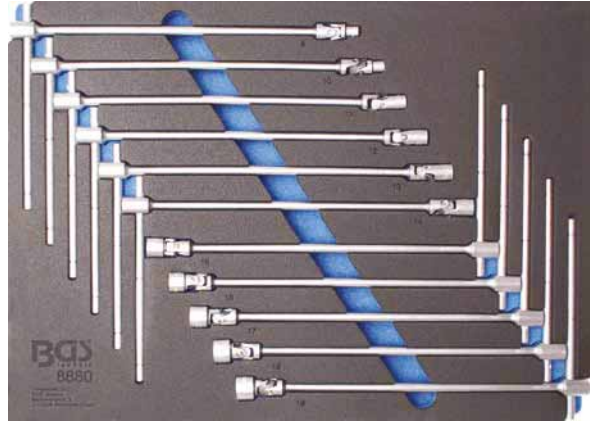

Item #	Description
8880-2	Tool Tray 3/3: T-Handle Universal Joint Socket Set 8 - 19 mm 11 pcs.
8880-1	Tool Tray 3/3, empty for Item 8880

Tool Tray 3/3: Sockets / Combination Spanners | Inch sizes | 90 pcs. 6.3 1/4 10 3/8 12.5 1/2

- sockets hexagon, 12.5 mm (1/2"): 3/8" - 7/16" - 15/32" - 1/2" - 9/16" - 19/32" - 5/8" - 21/32" - 11/16" - 3/4" - 25/32" - 13/16" - 7/8" - 15/16" - 1.1/16" - 1.3/16" - 1.1/4"
- sockets hexagon, deep, 10 mm (3/8"): 5/16" - 3/8" - 7/16" - 15/32" - 1/2" - 9/16" - 19/32" - 5/8" - 11/16" - 3/4"
- sockets hexagon, 10 mm (3/8"): 3/8" - 7/16" - 15/32" - 1/2" - 9/16" - 19/32" - 5/8" - 11/16" - 3/4"
- sockets hexagon, deep, 6.3 mm (1/4"): 5/32" - 7/32" - 1/4" - 9/32" - 5/16" - 11/32" - 3/8" - 7/16" - 15/32" - 1/2"
- sockets hexagon, 6.3 mm (1/4"): 5/32" - 3/16" - 7/32" - 1/4" - 9/32" - 5/16" - 11/32" - 3/8" - 7/16" - 15/32" - 1/2" - 9/16"
- bit sockets, 10 mm (3/8"), internal hexagon: 1/8" - 5/32" - 3/16" - 1/4" - 9/32" - 5/16" - 3/8"
- bit sockets, 6.3 mm (1/4"), internal hexagon: 3/32" - 1/8" - 5/32" - 3/16" - 7/32" - 1/4" - 9/32" - 5/16" - 3/8"
- combination spanners: 1/4" - 5/16" - 3/8" - 7/16" - 1/2" - 9/16" - 5/8"
- internal hexagon L-type keys, long side with ball point: 1/16" - 5/64" - 3/32" - 1/8" - 5/32" - 3/16" - 5/16" - 3/8"
- surface finish: satin chrome plated
- width: 567 mm
- height: 32 mm
- depth: 408 mm

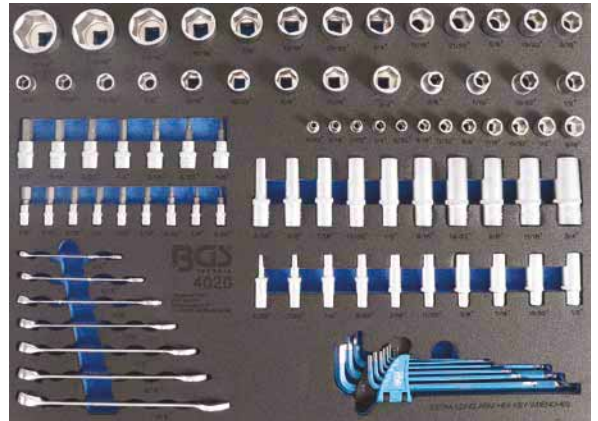

Item #	Description
4020	Tool Tray 3/3: Sockets / Combination Spanners Inch sizes 90 pcs.
4020-5	Tool Tray 3/3, empty for Item 4020

Tool Tray 3/3: Screwdriver Set | 23 pcs.

- cross slot, slot and T-Star (for Torx) screwdrivers
- cross and plain slotted screw drivers with additional square reception in handle
- screwdriver, 100 mm, cross slot PH: PH0 - PH2
- screwdriver, 75 mm, cross slot PH1
- screwdriver, 38 mm, cross slot PH2
- screwdriver, 150 mm, cross slot PH3
- screwdriver, 200 mm, cross slot PH4
- screwdriver, 100 mm, slot SL 3 mm - 6 mm
- screwdriver, 75 mm, slot SL 5 mm
- screwdriver, 38 mm, slot SL 6 mm
- screwdriver, 150 mm, slot SL 8 mm
- screwdriver, 200 mm, slot SL 10 mm
- screwdriver, 80 mm, T-Star (for Torx): T6 - T7 - T8 - T9 - T10
- screwdriver, 100 mm, T-Star (for Torx): T15 - T20 - T25 - T27 - T30
- screwdriver, 150 mm, T-Star (for Torx): T40
- width: 567 mm
- height: 32 mm
- depth: 408 mm

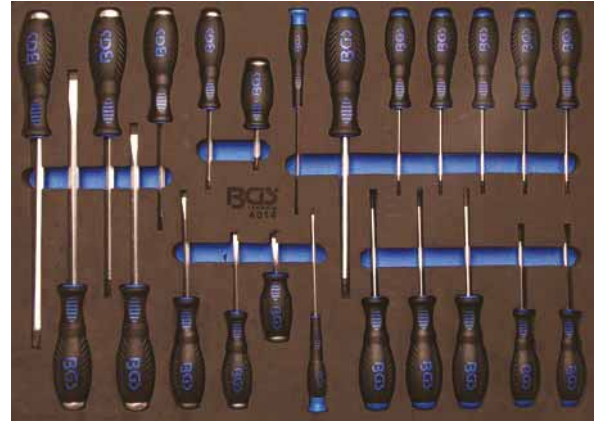

Item #	Description
4014	Tool Tray 3/3: Screwdriver Set 23 pcs.
4014-5	Tool Tray 3/3, empty for Item 4014

Tool Tray 3/3: T-Handle Socket Set | 9 pcs.

- ergonomically shaped T-handles
- T-handles sockets, 6-point Pro torque, length: 230 mm, 6 - 7 - 8 - 9 - 10 - 11 - 12 - 13 - 14 mm
- surface finish: satin chrome plated
- width: 567 mm
- height: 32 mm
- depth: 408 mm

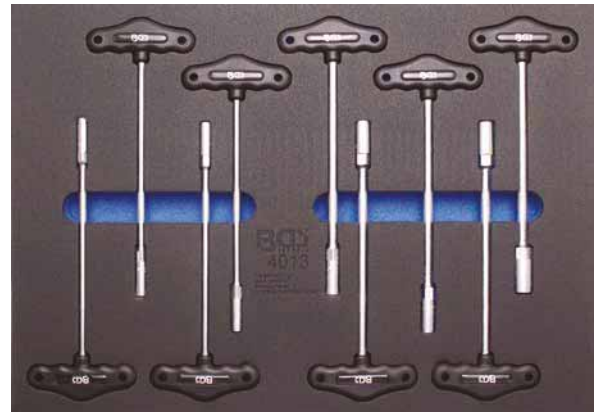

Item #	Description
4013	Tool Tray 3/3: T-Handle Socket Set 9 pcs.
4013-5	Tool Tray 3/3, empty for Item 4013

Tool Tray 3/3: T-Handle Screwdrivers | Internal Hexagon/T-Star (for Torx) | 18 pcs.

screwdrivers with T-handle and side blade in the following sizes:

- length 100 mm, T-Star (for Torx) T10
 - length 115 mm, T-Star (for Torx) T15
 - length 120 mm, T-Star (for Torx) T20
 - length 130 mm, T-Star (for Torx) T25
 - length 140 mm, T-Star (for Torx) T27
 - length 150 mm, T-Star (for Torx) T30
 - length 160 mm, T-Star (for Torx) T40
 - length 175 mm, T-Star (for Torx) T45
 - length 200 mm, T-Star (for Torx) T50
 - length 90 mm, 2 mm internal hexagon
 - length 100 mm, 2.5 mm internal hexagon
 - length 115 mm, 3 mm internal hexagon
 - length 120 mm, 4 mm internal hexagon
 - length 140 mm, 5 mm internal hexagon
 - length 160 mm, 6 mm internal hexagon
 - length 170 mm, 7 mm internal hexagon
 - length 175 mm, 8 mm internal hexagon
 - length 200 mm, 10 mm internal hexagon
- width: 567 mm
• height: 32 mm
• depth: 408 mm

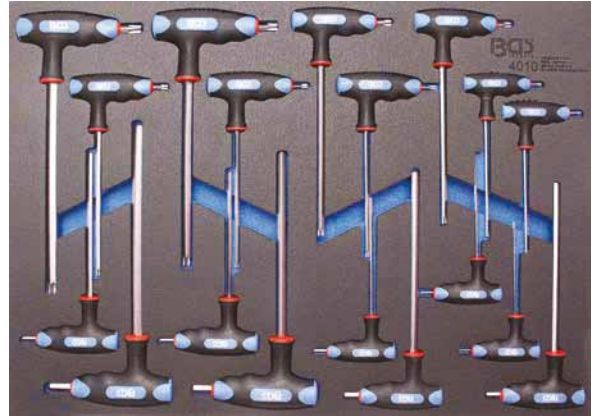

Item #	Description
4010	Tool Tray 3/3: T-Handle Screwdrivers Internal Hexagon/T-Star (for Torx) 18 pcs.
4010-20	Tool Tray 3/3, empty for Item 4010

Tool Tray 3/3: Pliers, Parallel Pin Punch Set, Hammer | 17 pcs.

- circlip pliers, straight, for outside circlips, 180 mm
 - circlip pliers, bent, for outside circlips, 180 mm
 - circlip pliers, straight, for inside circlips, 180 mm
 - circlip pliers, bent, for inside circlips, 180 mm
 - VDE combination pliers, 180 mm
 - VDE long nose pliers, 200 mm
 - VDE long nose pliers, angled, 200 mm
 - VDE diagonal cutter, 160 mm
 - VDE water pump pliers, 250 mm
 - machinist's hammer, hickory handle, DIN 1041, 500 g
 - locking pliers with vinyl grip release lever, 250 mm
 - 6 pin punches, 150 mm, sizes: 3 - 4 - 5 - 6 - 7 - 8 mm
- width: 567 mm
• height: 32 mm
• depth: 408 mm



Item #	Description
4011	Tool Tray 3/3: Pliers, Parallel Pin Punch Set, Hammer 17 pcs.
4011-5	Tool Tray 3/3, empty for Item 4011

Tool Tray 3/3: Special Tools for Tyre Service | 18 pcs.

12.5  1/2

- 4 plastic scrapers: 19 - 22 - 25 - 38 mm
- 1 pliers for wheel balancing weights
- 1 thread tap for tire valves
- 1 special socket for steel tire valves, 6.3 mm (1/4") drive
- 4 protective impact sockets with plastic coating, 12.5 mm (1/2") drive: 15 - 17 - 19 - 21 mm
- 2 valve core torque tools: 0.25 - 0.45 Nm
- 2 tire / valve tools
- 1 tire valve replacing tool
- 1 workshop torque wrench, 40 - 200 nm, 12.5 mm (1/2") drive
- 1 tire lever with plastic protection cover, 500 mm
- width: 567 mm
- height: 32 mm
- depth: 408 mm



Item #	Description
4047	Tool Tray 3/3: Special Tools for Tyre Service 18 pcs.
4047-1	Tool Tray 3/3, empty for Item 4047

Tool Tray 3/3: Release Tools, Assembly Wedge and Hook Set | 17 pcs.

- trim strip set, manufactured from high end special plastic, various shapes for working on trim strips, rubber gaskets, interiors, door trims, switches, etc.
- hook set is needed for laying of cables, stuffing seats, etc., all hooks with 2-component handles
- trim strip wedge, made from plastic, for damage-free removal of trim strips: 100 x 45 mm - 185 x 25 mm
- door trim removing tool for removal of trim strips on car body, can be used for nearly all brands
- assembly wedge assortment made from special hard plastic / nylon, for working on car interior lining, cover panel, dashboard, trim strips
- trim strip wedge, length: 160 - 200 mm
- piercer, straight
- hook 90° angled
- hook with round head
- double angled hook
- trim strip wedges made of plastic: 100 x 45 mm - 185 x 25 mm
- windshield moulding release tool
- assembly wedge assortment
- width: 567 mm
- height: 32 mm
- depth: 408 mm



Item #	Description
4034	Tool Tray 3/3: Release Tools, Assembly Wedge and Hook Set 17 pcs.
4034-1	Tool Tray 3/3, empty for Item 4034

Tool Tray 3/3: Trim Wedges and Scraper Set | 27 pcs.

- for removal of trim, paneling, etc.
- allows a damage-free disassembly, even on painted surfaces
- wide range of application due to different scraper and removal tool profiles, such as:
 - scraper with trim guide
 - slotted lever, angled and straight
 - disassembly lever, angled and straight
 - in different widths
- width: 567 mm
- height: 32 mm
- depth: 408 mm



Item #	Description
4033	Tool Tray 3/3: Trim Wedges and Scraper Set 27 pcs.
4033-1	Tool Tray 3/3, empty for Item 4033

Tool Tray 3/3: Engine Timing Tool Set | for Renault, Nissan, Opel, Volvo

for checking and adjusting the engine timing on following models:

- Renault: Clio 1-2-3-4, Clio Sport 1-2-3, Mégane 1-2-3, Master 1-2, Mégane Scénic 1-2-3, Vel Satis 1-2, Avantime, Kangoo 1-2-3, Laguna 1-2-3, Espace 1-2-3, Trafic 1-2, Wind, Modus, Twingo, Koleos
- Dacia: Logan, Duster, Sandero, Dokker
- Nissan: Note, Qashqai, Micra, Interstar, Primastar, Kubistar, Almera, Primera
- Opel: Vivaro, Movano
- Volvo: S 40, V 40

suitable for Gasoline and Diesel engines:

- 1.2 - 1.2 16V - 1.4 - 1.4 16V - 1.5DCI - 1.6 - 1.6 16V, 1.6D - 1.7 - 1.8 - 1.8 16V - 1.9TD - 1.9 - 1.9DCI, 1.9DTI - 1.9CDTI - 2.0 - 2.0 16V - 2.1TD - 2.2, 2.2DCI - 2.2DTI - 2.2TD - 2.5DCI - 2.5CDTI - 2.5TD - 2.8D

scope of delivery:

- camshaft locking tools, to be used as OEM MOT 1496, MOT 1750, MOT 1337, MOT 1534, KM-6205, MOT 1537, KM-6204
- camshaft gear adjusting tool, to be used as OEM MOT 1490-01
- crankshaft locking pins, to be used as OEM MOT 1054, KM-6031, KV113 B0280, MOT 1489, KV113 B0130, MOT 1340, MOT 910, MOT 1318, MOT 1489, MOT 1337, MOT 1536, KM-6203, MOT 1054
- tensioning tools, to be used as OEM MOT 1348, MOT 1312, MOT 1384, MOT 1135-01, MOT 1543, KM-6234, KV113 B0360, MOT 1386
- screw M6 x 45 mm
- screw M8 x 80 mm
- high pressure injection pump locking pins, to be used as OEM MOT 1538, MOT 1200-01

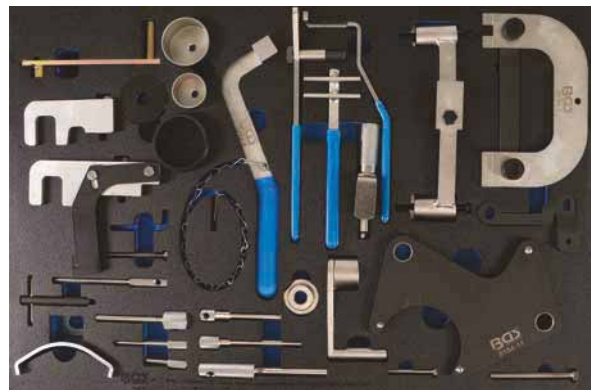

Item #	
4134	

Tool Tray 3/3: Engine Timing Tool Set | for Fiat, Ford, Citroen, Peugeot

for adjusting the engine timing when renewing the tooth belt, replacing cylinder head gasket, etc. suitable for following models:

- Fiat Ulysse, Scudo, Ducato
- Lancia Zeta, Phedra
- Ford Fiesta, Fusion, Focus, Focus C-Max
- Citroen C15, C1, C2, C3 Pluriel, C4, C4 Picasso, C5, C6, C8, DS3, DS4, DS5, Xantia, Xsara, Xsara Picasso, Evasion, Berlingo, Jumpy, Jumper, Saxo, ZX, XM, Evasion, AX
- Peugeot 107, 1007, 206 cc, 207, 208, 306, 307 cc, 308, 406, 407, 508, 607, 806, 807, Partner, Expert, Boxer, 206, 106, 605, 205, 405
- Lancia / Fiat 2.0 & 2.2 JTD

suitable for engines:

- DW12TED4 (4HW), DW10ATED (RHT/RHV/RHW/RHX/RHZ)
- Ford 1.4 / 1.6 Duratorq TDCI
Motorcodes: F6JA, F6JB, F6JC, G8DA, G8DB, HHDA, HHDB, HHJA, HHJB
- Citroen / Peugeot 1.0 / 1.1 / 1.4 / 1.6 / 1.6 16V, 1.4 / 1.6HDI / 1.8 / 1.8 16V / 2.0 / 2.0 Turbo, 1.9D / 2.0HDI / 2.2HDI / 1.8 16V / 2.0 16V

scope of delivery:

- flywheel puller, to be used as OEM 0188-P2, 0188-P, 174, 7015-T
- tensioner pulley locking levers, to be used as OEM 0188-J1, 0188-J2
- tensioner pulley locking pins, to be used as OEM 0188-Q2, 0188-AH, 0189-S2
- timing belt retaining clip, to be used as OEM 0132-AK, 0188-AK, 0189-K, 0153-AK, 4533-TAD, MOT 1436
- flywheel locking pins, to be used as OEM 0153-N, 0188-Y, 7014-TJ, 7099-TM, 9797-34, 0188-D, 7017-TM, 0132-P, 4507-TL, 7017-TR, 0153-M, 0178-C, 0178-D, 7014-TM, 9767-94, 0189-B, 21-163, 0132-AJ1, 0153-G, 0188-M, 0189-J, 4533-TAC1, 5711-TA, 0189-L, 0189-C, 0189-R, 0153-U, 7019-T, 0132-Q, 0132-QZ, 4507-TA, 9767-27, 0132-X, 0188-Q1, 4507-TJ, 9767-89
- tensioner pulley locking pins, to be used as OEM 4200-TH, 0117-AR
- tensioning tool, to be used as OEM 0178-E
- flywheel locking tool, to be used as OEM 0153-A, 6012-T, 9765-54, 0134-AF, 0134-Q, 0188-F, 9004-T
- pulley locking lever, to be used as OEM 0606-A1-A2
- tensioner pulley adjusting tool, to be used as OEM 0189-S1



Workshop Trolley Tool Trays

Item #		
4135		

Tool Tray 3/3: Engine Timing Tool Set | for Ford, VAG, Mazda, Volvo

for checking and adjusting the engine timing on following models:

- Audi 80, A1, A2, A3, S3, A4, A5, A6, TT, Q5
- Seat Arosa, Ibiza, Cordoba, Leon, Toledo, Alhambra, Altea, Inca (99-04)
- Skoda Fabia, Octavia, Superb
- VW Lupo, Polo, Fox, Golf, Bora, Jetta, Golf Plus, Passat, Beetle, Touran, Sharan, Caddy, Caddy Maxi, Transporter, Golf VI Cabrio, Tiguan
- Ford Galaxy

Petrol engines:

1.2 TSI / 1.4 / 1.4 TSI / 1.6 16V / 1.2 9V-12V 3-Zyl., 1.4 / 1.6 FSi (Camshaft Timing Chain), 1.8 / 1.8 16V / 1.8T / 2.0 16V / 2.0 FSi / TFSI (Timing Belt)

Diesel engines:

1.2 / 1.4 / 1.9 / 2.0 TDI PD, 1.9 TDI 75-90-110, 1.9 SDI 75-90-110, 1.9 TDI 105-130-150, 2.0 TDI DPF 140-170, 2.5 TDI V6

scope of delivery:

- camshaft locking & adjusting tools, to be used as OEM 3458, T30094, T10016, T10074, T10074, MP1-1312, T10098, T20038, 3418, T10123, T10121, T10120, T10252, T10171, 2065-A, 21-105
- crankshaft locking & adjusting tools, to be used as OEM 3242, T40069, T30052, T40026, T10414, T10100, T10340, T10341
- injection pump locking & adjusting tools, to be used as OEM 3359, T20102, 2064, U20003
- chain tensioner, tooth belt tensioner & drive belt tensioner tools, to be used as OEM 23-058, 310-084, T10008, 2065A, T10008, U40021, T10092, T40011, T10060, T10060A, T00115, T10264, T40098, 303-1054, T10115, T10092, T40011, T00115, T10264, T40098
- chain tensioner / crankshaft sprocket holder, to be used as OEM 3366, T20018, T20044
- crankshaft sprocket aligning tool, to be used as OEM 23-059, 310-085, T10050
- lever / wrench for tensioning tooth belt, to be used as OEM 3387, U30009A, 2587, MATRA V.159, 3387, T10020
- locking bracket, to be used as OEM MP1-1312, T10098, T20038
- support guides, to be used as OEM OEM 3369, T30092, 3411
- TDC indicator, to be used as OEM T10170
- dial test indicator, to be used as OEM VAS6079



Item #		
4136		

Tool Tray 3/3: Engine Timing Tool Set | for Fiat, Alfa, Lancia, Opel, Suzuki, Ford

for checking and adjusting the engine timing on following models:

- Alfa Romeo 145 / 146 / 147 / 155 / 156 / 159 / 166 /
- Spider / GTV / TS / GT / Crosswagon Q4
- Fiat Punto / Grande Punto / Brava / Bravo / Marea / Weekend / Stilo / Doblo / Cargo / Idea / Panda / Multipla / Palio / Stilo / 500
- Lancia Lybra / Ypsilon / Thesis / Musa
- Opel Corsa / Agila / Meriva / Combo / Vectra / Zara / Astra / Insigna / Signum 1.9 CDTI
- Suzuki Ignis / Swift / Wagon R+
- Ford Ka

engines:

- 1.2 8V / 1.2 16V / 1.4 16V / 1.6 16V / 1.6 MultiJet / 1.9 JTD / 1.9 JTD 16V / 1.9 MultiJet / 1.9 CDTI / 2.0 MultiJet / 2.4 JTD 20V / 2.4 JTD / 1.3 JTD MultiJet / 1.3 CDTI / 1.3 TDCI / 1.9 CDTI

includes following special tools:

- camshaft locking & adjusting tools, to be used as OEM 1860874000, 1860874000, 1860985000, 1825041000, 1825041000, 1825042000, 1825042000, 1860847000, 1860847000, 2000004300, 1871000900, 2000004400, 2190754400, 1870896900
- crankshaft & flywheel locking tools, to be used as OEM 1860161000, 1860905000, EN-46788, 1860771000, 1860898000, 1860863000, 1870900300, 1860703000, 2190754500, 2000004200, 2190754200, 1860905000, 2000004500, 2190754500
- injection pump adjusting tools, to be used as OEM 1860965000
- tensioning tools, to be used as OEM 1860876000, 1860987000, 1860845000, 1860876000, 1870900400
- OT indicators, to be used as OEM 1860992000, 1895443000



Workshop Trolley Tool Trays

Item #		
4137		

Tool Tray 3/3: Engine Timing Tool Set | for Fiat, Alfa, Lancia, Opel, Suzuki, Ford

for checking and adjusting the engine timing on following models:

- Opel Corsa B/C / Combo / Tigra / Agila / Tigra B / Meriva / Astra F/G/H / Astravan / Speedster VX220 / Zafira A/B / Vectra B/C / Signum / Omega B / Sintra / Frontera A/B / Astravan / Kadett / Ascona / Omega / Monterey / Antara / Croma / Speedster VX220
- Chevrolet & Daewoo Epica / Captiva / Nubira / Lacetti / Evanda
- Saab 9-3 / 9-5 (98-04)
- Alfa 145 / 146 / 147 / 156 / 159 / 166
- GT / Crosswagon Q4
- Fiat Punto / Grande Punto / Bravo / Brava / Marea Weekend / Stilo / Doblò/Cargo / Multipla
Idea / Panda
- Lancia Ypsilon / Musa / Lybra / Thesis
- Suzuki Ignis / Swift / Wagon R+
- Ford Ka

engines:

- 1.0 12V / 1.0 16V / 1.2 16V / 1.4 / 1.6 / 1.2-1.4 16V (chain) / 2.0 / 2.0 Turbo / 2.2 DI / 2.0-2.2 16V / 1.6 16V / 1.8 16V / 2.0 16V / 2.2 16V / 1.3 JTD MultiJet / 1.3 CDTI / 1.3 TDCI / 1.6 MultiJet / 1.9 JTD / 1.9 MultiJet / 2.4 JTD / 1.9 CDTI / 2.0 MultiJet / 1.5 D / 1.5 TD / 1.7 D / 1.7 TD / 1.6-1.7 D / 3.0 TD / 3.1TD / 2.0-2.2-2.4 TD / 2.0-2.2 DI / 2.0 TDCI / 2.0 D VCDI / 2.2 16V (DOHC)

includes following special tools:

- adjusting wrench, to be used as OEM KM-933
- injection pump locking pin, to be used as OEM KM-927
- flywheel & crankshaft locking tools, to be used as OEM KM-929 / KM-952 / EN-46785 / KM-951 / 1860905000 / 1860905010 / EN-46788 / KM-911 / EN-46785 / 1860703000 / EN-48246 / 1870900300 / 303-1468
- tensioner tools, to be used as OEM KM-955 / KM-6130 / KM-6349 / KM-6349 / 1870900400 / 1871000200



Item #		
4138		

Tool Tray 3/3: Engine Timing Tool Set | for Ford, VW, Seat, Mazda, Volvo

for checking and adjusting the engine timing on following models:

- Ford Fiesta, Fusion, Courier, Escort, Focus, Focus C Max, Puma, Mondeo, Sierra, Cougar, Galaxy, C-Max, Orion, Tourneo Connect, Transit, Transit Connect
- VW Sharan
- Seat Alhambra
- Mazda 121
- Volvo S40, V50

Gasoline engines:

- 1.2 / 1.25 / 1.4 / 1.6 / 1.6 / 1.7 / 1.8 / 2.0 16V / 1.6 TI-VCT / 1.6 SCTI

Diesel engines:

- 1.6 Duratorq TDCI / 1.8D / 1.8TD / 1.8 DI (98-04) / 1.8 TDCI (01-04) / 1.6D / 1.9TDI / 2.5D TCI / 1.9TDI / 2.5D/TCI / 1.4TDCI / 1.6TDCI / 1.8D / 1.8TCI / 1.8TDDI / 1.8TDCI / 1.8D Turbo / 1.9TDI PD / 2.0TDCI / 2.2TDCI / 2.5D / 2.5D Turbo / 2.0 / 2.2 / 2.4 Duratorq TDCI 16V / 1.4TDCI / 1.6D 8V / 1.6D 16V

scope of delivery:

- camshaft adjusting tools, to be used as OEM 21-105, 303-1061, 21-162B, 303-367, 303-376, 323-029
- injection pump adjusting tools, to be used as OEM 2064, 23-047, 310-055, U20003, 21-260, 303-732, 23-020, 21-238, 303-679A, 303-1151
- flywheel / crankshaft locking tool, to be used as OEM 303-1060, 0132-AB, 0178-D, 21-151, 0194-B, 21-263, 303-735, 49JE02021, 21-234, 21-251, 0194-C, 21-262, 303-734, 21-163, 303-620, 21-210, 21-123, 21-234, 21-251, 303-675, 303-698
- camshaft sprocket puller, to be used as OEM 21-229, 303-651
- feeler gauge



Workshop Trolley Tool Trays

Item #		
4139		

Hose Clamp Pliers Set in Tool Tray

- dimensions (W x D x H) 570 x 410 x 30 mm
- BGS 8412 ratcheting hose clip pliers 0 - 38 mm
 - gripper opening from 0 up to 38 mm
 - ratchet locking function
 - opens using spring mechanism
- BGS 471 hose clip pliers CLIC / -R
 - 190 mm long
 - turnable, angled jaws
- BGS 473 Ratcheting Hose Clip Plierslong
 - max. capacity:
 - for spring pipe clamps
 - interchangeable jaws (2 pairs)
 - length 200 mm
- BGS 161 CV-Joint Boot Pliers
 - with ear-type holder, prevents loosening of sleeve fastening
 - universal use, works on steering gear gaiters, fuel hoses
 - for working on Oetiker System hose clamps
 - length 235 mm
- BGS 8600 Hose Clamp Pliers
 - specifically made for space-saving hose clips
 - ratchet mechanism for holding hose clips open
 - especially suitable for new type hose clips on VAG fuel lines
- BGS 470 Bowden Ratcheting Hose Clip Plierslong
 - universal hand-tool for installation and removal of 18 - 54 mm long elastic, self-locking, spring steel collars
 - due to the Bowden cable can be used even in narrow spaces
 - length 630 mm
- Hose Clamp Clamping Tool
 - suitable for spring steel band clamps
 - by turning the knurled nut, the tool opens the hose clamp and it can remain in this position until the disassembly / assembly is complete
 - max. opening: 62 mm

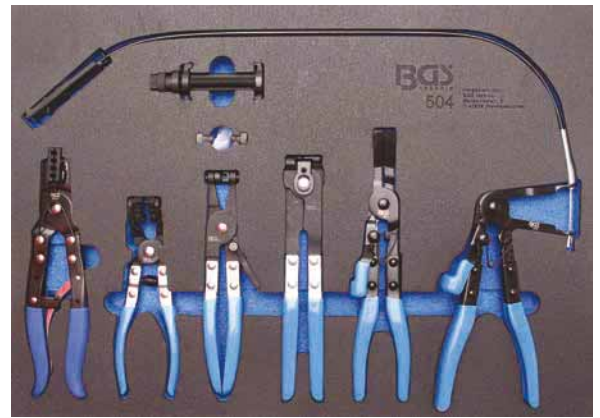

Item #
504

Magnetic Shell | stainless steel | Ø 150 mm

- stainless steel
- very strong magnet, rubber coated

Item #
1150



Magnetic Shell | stainless steel | 265 x 290 mm

- stainless steel
- very strong magnet, rubber coated

Item #
1151



Magnetic Shell | deep Type | Ø 145 mm

- all purpose: use in workshop, construction, car repair, etc.
- special high finish allows storing of non-magnetic small parts like aluminium, brass, stainless steel as well as large magnetic tools and parts
- very strong magnet, rubber coated

Item #
67100



Magnetic Parts Shell with Shield

- rubberized magnet for protecting surfaces from scratches
- adjustable shield for better hold of items in vertical or horizontal position
- magnetic force: 5 kg
- shell material: stainless steel with polystyrene rim
- shield dimensions: 249 x 56 mm
- length: 249 mm
- width: 152 mm
- height: 54 mm

Item #
67102



Magnetic Shell Set | 150 / 210 / 310 mm | 3 pcs.

- 3 shelves with strong magnet
 - individually attachable
 - sticks to all metal surfaces
 - perfect storage box for tools, aerosol cans and other tools
-
- 1 storage compartment 145 x 115 mm, max. load capacity 2.0 kg
 - 1 storage compartment 210 x 115 mm, max. load capacity 4.0 kg
 - 1 storage compartment 310 x 115 mm, max. load capacity 5.0 kg

Item #
67150



Magnetic Can Storage Tray | 210 mm

- fits three standard spray cans Ø 73 mm
- 6 strong magnets, capacity approx. 1.8 kg
- 10 holes on bottom position Ø 19 mm (for screwdrivers etc.)
- dimensions: 210 x 75 x 70 mm



Item #
67156

Magnetic Paper Towel Holder | 2 pcs.

- with strong magnets, capacity approx. 2 kg
- maximum diameter 140 mm
- holder Ø 33 mm



Item #
67159

Magnetic Holder | 4.5 kg

- for air tools / other tools
- rated load capacity: 4.5 kg



Item #
1158



Magnetic Cup Holder

- can fit coffee mugs, pop cans, water bottles and more
- powerful magnet on backside
- diameter 88 mm
- height: 188 mm



Item #
67160

Magnetic Air Tools Holder

- holds air impact wrenches, wheel nut sockets and torque wrenches on lifting platforms - 2 strong magnets
- capacity: 15 kg

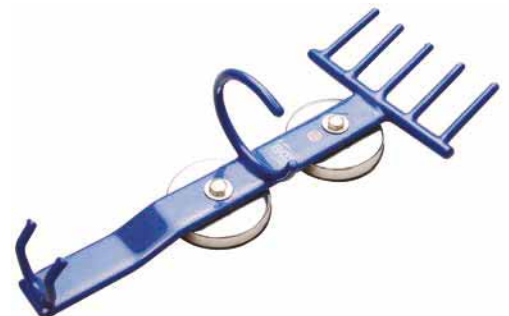

Item #
1159

Socket Holders | magnetic

- sockets are held by magnetic strip
- with strong holding magnet
- 3011-1 for holding 10 x 6,3 mm (1/4") sockets
- 3011-2 for holding 12 x 10 mm (3/8") sockets
- 3011-3 for holding 12 x 12,5 mm (1/2") sockets



Item #	Description
3011-1	Socket Holder magnetic for 6.3 mm (1/4") drive
3011-2	Socket Holder magnetic for 10 mm (3/8") drive
3011-3	Socket Holder magnetic for 12.5 mm (1/2") drive



Socket Holders with square for 12 Sockets | magnetic

- for holding 12 sockets
- magnets on the backside with foam rubber protection for mounting in drawers, etc. on workshop trolleys.
- with square retaining edges made from plastic
- length: 310 mm, width: 23 mm, height: 24 mm



Item #	Description
9342	Socket Holder with square for 12 Sockets magnetic for 6.3 mm (1/4") drive
9343	Socket Holder with square for 12 Sockets magnetic for 10 mm (3/8") drive
9344	Socket Holder with square for 12 Sockets magnetic for 12.5 mm (1/2") drive

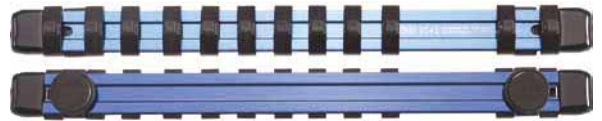

Paper Roll Holder for Workshop Trolley PRO

- suitable for workshop trolley BGS 4111+4102
- suitable for paper rolls with max. diameter 300 mm and max. width 275 mm
- can be attached to pre-punched holes

Item #
67161



Document Tray for Workshop Trolley PRO

- suitable for workshop trolley BGS 4111+4102
- especially suitable for documents, but also for tools, parts, etc.
- can be attached to pre-punched holes
- inner length 297 mm
- inner width 55 - 105 mm
- inner height 220 mm



Item #
67162

Document Tray for Workshop Trolley PRO

- suitable for workshop trolley BGS 4111+4102
- especially suitable for spray cans, tools, parts, etc.
- dimensions (inner): 297 x 77 x 53 mm
- can be attached to pre-punched holes
- inner length 297 mm
- inner width 77 mm
- inner height 53 mm



Item #
67163

Plastic Hood for Workshop Trolley | 730 x 475 mm

- suitable for workshop trolley BGS 4111
- length: 730 mm
- width: 475 mm



Item #
67164

Wood Panel Insert for Workshop Trolley Pro

- suitable for PROFI workshop trolley BGS 4111+4102
- suits into plastic hood
- length: 470 mm
- width: 390 mm
- height: 12 mm



Item #
67165

Drawer Divider for Workshop Trolley | 6 pcs.

- suitable for workshop trolley BGS 4111+4102
- consists of 2 support rails and 4 divider sheets
- support rails with 17 divider plate holding slots, with distance of approx. 2.5 cm
- dimensions of support rails: width 565 mm / height 20 mm
- dimensions of divider plates: depth 380 mm / height 40 mm



Item #
67166

Plastic Storage Trays | for Workshop Trolley | 17 pcs.

- suitable for all BGS workshop trolleys
- suitable for small parts, screws, hose clamps and more
- trays can be put in many ways inside the drawer
- front side with inset area for index map
- 5 plastic trays 70 x 70 x 45 mm
- 9 plastic trays 145 x 70 x 45 mm
- 3 plastic trays 145 x 145 x 45 mm



Item #
9550

Replacement Locks for BGS Tool Trolleys

- replacement lock, incl. 2 keys



Item #	Description
2001-9	Lock incl. Key for Workshop Trolley BGS 2001
4100-9	Lock incl. Key for Workshop Trolley BGS 4100
4110-9	Lock incl. Key for Workshop Trolley BGS 4110
4111-9	Lock incl. Key for Workshop Trolley BGS 4111

Replacement Wheels for Workshop Trolleys

- ball bearing wheel and mounting plate
- wheel dimensions:

2001-2

- wheel diameter: 128 mm
- total height: 155 mm
- mounting plate dimensions: 75 x 93 mm
- mounting hole distance: 44 x 74 mm

2001-3

- wheel diameter: 128 mm
- total height: 155 mm
- mounting plate dimensions: 75 x 93 mm
- mounting hole distance: 44 x 74 mm

4100-3

- wheel diameter: 127 mm
- total height: 165 mm
- mounting plate dimensions: 100 x 107
- mounting hole distance: 85 x 71 mm

4100-4

- wheel with ball bearing
- wheel diameter: 160 mm
- centre drills: 14 mm

4110-2

- wheel diameter: 125 mm
- total height: 165 mm
- mounting plate dimensions: 102 x 115
- mounting hole distance: 85 x 71 mm

4110-3

- wheel diameter: 125 mm
- total height: 165 mm
- mounting plate dimensions: 102 x 115
- mounting hole distance: 85 x 71 mm

4111-2

- wheel diameter: 125 mm
- total height: 165 mm
- mounting plate dimensions: 99 x 116
- mounting hole distance: 85 x 71 mm

4111-3

- wheel diameter: 125 mm
- total height: 165 mm
- mounting plate dimensions: 101 x 114
- mounting hole distance: 85 x 71 mm



Item #	Description
2001-2	Caster Wheel for Workshop Trolley BGS 2001
2001-3	Wheel with Base for Workshop Trolley BGS 2001
4100-3	Caster Wheel for Workshop Trolley BGS 4100
4100-4	Wheel with base for Workshop Trolley BGS 4100
4110-2	Caster Wheel for Workshop Trolley BGS 4110
4110-3	Wheel with Base for Workshop Trolley BGS 4110
4111-2	Caster Wheel for Workshop Trolley BGS 4111
4111-3	Wheel with Base for Workshop Trolley BGS 4111

Socket Set | 6.3 mm (1/4") drive | 53 pcs.

6.3  1/4

tools with drive: 6.3 mm (1/4")

- 1 reversible ratchet, 72 teeth, with quick release button
- 1 sliding bar
- 1 universal joint
- 1 spinner handle, 150 mm
- 2 extensions 50 & 100 mm
- 6 sockets, deep, Pro torque®: 8 - 10 - 11 - 12 - 13 - 14 mm
- 3 bit sockets cross slot (PH1 - PH2 - PH3)
- 3 bit sockets slot 4 - 5.5 - 6.5 mm
- 6 x bit sockets internal hexagon 3 - 4 - 5 - 6 - 7 - 8 mm
- 6 bit sockets T-star tamperproof (for Torx) T10 - T15 - T20 - T25 - T30 - T40
- 13 sockets, Pro torque®: 4 - 4.5 - 5 - 5.5 - 6 - 7 - 8 - 9 - 10 - 11 - 12 - 13 - 14 mm
- 7 E-type sockets: E4 - E5 - E6 - E7 - E8 - E10 - E11
- 3 wrenches internal hexagon 1.5 - 2.0 - 2.5 mm

Item #
2147



Socket Set | 6.3 mm (1/4") drive | 46 pcs.

6.3  1/4

- T-Star sockets **NOT tamperproof**
- 1 adaptor external hexagon 6.3 mm (1/4") x external square 6.3 mm (1/4")
- 1 spinner handle
- 2 extension bars 50 & 100 mm
- 1 universal joint
- 1 sliding t-bar
- 1 flexible extension bar
- 1 reversible ratchet, fine 72 tooth
- 3 L-wrenches for internal hexagon 1.5 - 2 - 3 mm
- 6 bit sockets, T-Star not tamperproof (for Torx): T10 - T15 - T20 - T25 - T30 - T40
- 6 bit sockets internal hexagon: 3 - 4 - 5 - 6 - 7 - 8 mm
- 3 slotted bit sockets: 4 - 5.5 - 7 mm
- 3 PH cross slot bit sockets: PH1 - PH2 - PH3
- 3 PZ cross slot bit sockets: PZ1 - PZ2 - PZ3
- 13 "Super Lock" sockets, 6.3 mm (1/4") drive: 4 - 4.5 - 5 - 5.5 - 6 - 7 - 8 - 9 - 10 - 11 - 12 - 13 - 14 mm

Item #
2145



Socket Set | 6.3 mm (1/4") drive | 46 pcs.

6.3  1/4

- T-star sockets **tamperproof**
- 1 adaptor external hexagon 6.3 mm (1/4") x external square 6.3 mm (1/4")
- 1 spinner handle
- 2 extension bars 50 + 100 mm
- 1 universal joint
- 1 sliding t-bar
- 1 flexible extension bar
- 1 reversible ratchet, fine 72 tooth
- 3 L-wrenches for internal hexagon 1.5 - 2 - 3 mm
- 6 bit sockets, T-Star tamperproof (for Torx): T10 - T15 - T20 - T25 - T30 - T40
- 6 bit sockets internal hexagon: 3 - 4 - 5 - 6 - 7 - 8 mm
- 3 slotted bit sockets: 4 - 5.5 - 7 mm
- 3 PH cross slot bit sockets: PH1 - PH2 - PH3
- 3 PZ cross slot bit sockets: PZ1 - PZ2 - PZ3
- 13 "Super Lock" sockets, 6.3 mm (1/4") drive: 4 - 4.5 - 5 - 5.5 - 6 - 7 - 8 - 9 - 10 - 11 - 12 - 13 - 14 mm

Item #
2146



Socket Set | 6.3 mm (1/4") | Inch sizes | 46 pcs.

6.3  1/4

- knurled
- satin chrome plated
- ratchet, 72 teeth
- 50 mm extension bar
- 100 mm extension bar
- 100 mm flexible extension
- sliding bar
- handle
- universal joint
- incl. adaptor external hexagon 6.3 mm (1/4") to external square 6.3 mm (1/4")
- 5/32" - 3/16" - 7/32" - 1/4" - 9/32" - 5/16" - 11/32" - 3/8" - 7/16" - 15/32" - 1/2" - 9/16"
- bit sockets T-Star (for Torx) T10 - T15 - T20 - T25 - T30 - T40
- internal hexagon: 3/32" - 1/8" - 5/32" - 3/16" - 7/32" - 1/4" - 9/32" - 5/16" - 3/8"
- bit sockets slot 4 - 5.5 mm
- bit sockets cross slot PZ1 - PZ2 - PZ3

Item #
2141



Socket Set, Gear Lock | 6.3 mm (1/4") drive | 39 pcs.

6.3  1/4

- the special „gear-lock-profile" provides universal use of 3-pt, 4-pt, 6-pt, 12-pt and T-STAR screws, in metric and inch sizes
- misc. bits and accessories
- for 6- and 12-point from 4.0 to 14.0 mm and 5/32" - 1/2", E5 - E6 - E8 - E10 - E12 - E14 - E16 - E18

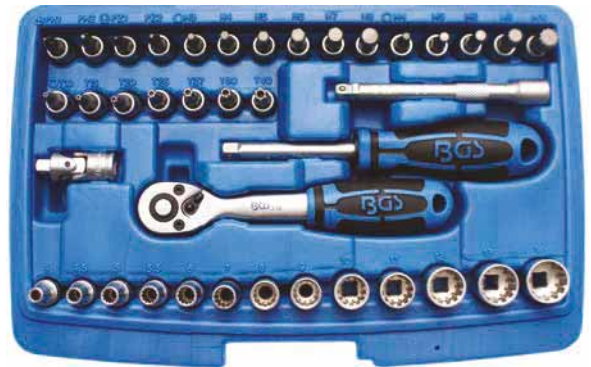

Socket Set | 6.3 mm (1/4") drive | 46 pcs.

6.3  1/4

- sockets and extension bars, knurled
- extension bars with external hexagon
- in double blister packaging
- 1 reversible ratchet, serrated 72 teeth
- 1 universal joint
- 3 hexagon wrenches
- 1 bit adaptor
- 1 spinner handle
- 3 extension bars
- 12 „super lock" sockets 6.3 mm (1/4") drive: 4 - 13 mm
- 24 bits, 6.3 mm (1/4") drive:
 - cross slot PH, cross slot PZ, slot, T-Star tamperproof (for Torx), internal hexagon



Socket Set | 6.3 mm (1/4") drive | 28 pcs.

6.3  1/4

- packed in a convenient hard-top case
- 1 fine 72 tooth ratchet (extra short, just 108 mm)
- 1 extension bar 6.3 mm (1/4"), 50 mm
- 1 bit holder
- 9 sockets with Gear Lock profile: 5 - 6 - 7 - 8 - 9 - 10 - 11 - 12 - 13 mm
- the Gear Lock profil" can be used for hexagon, 12-point, E-type, metric + inch nuts
- 16 bits, S-2 special steel, 6.3 mm (1/4") drive:
 - cross slot PH1 + PH2 / PZ1 + PZ2
 - plain slot 4.5+6 mm
 - internal hexagon 3 + 4 + 5 mm
 - T-Star (for Torx) T10 - T15 - T20 - T25 - T27 - T30 - T40



Ratchet Wrench Set

6.3  1/4

includes following tools with 6.3 mm (1/4") drive:

- S-shape ratchet wrench, reversible, one side suitable for sockets, the other side for bits, fine 72-tooth
- S-shape wrench for working in "impossible" areas
- 50 mm extension bar
- universal joint
- bit holder
- sockets hexagon: 5 - 6 - 7 - 8 - 9 - 10 - 11 - 12 - 13 mm
- bits internal hexagon: 3 - 4 - 5 - 6 - 8 mm
- bits T-Star (for Torx): T15 - T20 - T25 - T27 - T30
- bits cross slot: PH1 - PH2 - PH3
- bits cross slot: PZ1 - PZ2 - PZ3
- bits slot: 4.5 - 5 - 5.5 - 7 mm



Item #	
2242	

Multi-Screwdriver | Gear Lock

suitable for the following screw heads:

- external hexagon 8 - 10 - 11 - 13 - 14 - 16 - 17 mm
- external Torx screw heads (E-type) E10 - E12 - E14 - E16 - E18 - E20 - E22
- inch sixes - external hexagon 5/16" - 3/8" - 7/16" - 1/2" - 9/16" - 5/8" - 11/16"
- as well as a holder for 6.3 mm (1/4") bits



Item #	
8398	

Socket Set | 10 mm (3/8") drive | 61 pcs.

10  3/8

- bit sockets T-Star (for Torx): T15 - T20 - T25 - T2 - T30 - T40 - T45 - T50 - T55
- bit sockets cross slot PH1 - PH3
- bit sockets cross slot PZ1 - PZ3
- bit sockets slot 5.5 - 7 - 8 mm,
- bit sockets internal hexagon 3 - 7 - 8 - 10 mm
- "Super Lock" (wave profile type) sockets, hexagon 6 - 24 mm
- 10 "Super Lock" sockets, deep, 8 - 19 mm
- 2 spark plug sockets 21 + 16 mm
- 1 universal joint external/internal square 10 mm (3/8")
- 1 slid. tee bar/extension bar 250 mm
- 1 wobble extension bar 75 mm
- 1 fine 72 tooth reversible ratchet
- 1 adaptor external square 10 mm (3/8") external hexagon 8 mm



Item #	
2229	

Socket Set, Hexagon | 10 mm (3/8") drive | 61 pcs.

10  3/8

tools with drive: 10 mm (3/8")

- fine toothed ratchet head, 72 teeth
- 75 mm extension bar
- sliding bar adaptor
- universal joint
- hexagon adaptor 8 mm
- spark plug sockets 16 + 21 mm
- 18 sockets, hexagon: 6 - 8 - 9 - 10 - 11 - 12 - 13 - 14 - 15 - 17 - 19 - 20 - 21 - 22 - 24 mm
- 10 sockets, hexagon, long: 8 - 9 - 10 - 11 - 12 - 13 - 14 - 15 - 17 - 19 mm
- 25 bit sockets
 - slot sl 5.5 - 7 - 8 mm
 - cross slot PH1 - PH2 - PH3
 - cross slot PZ1 - PZ2 - PZ3
 - internal hexagon 3 - 4 - 5 - 6 - 7 - 8 - 10 mm
 - T-Star (for Torx) T15 - T20 - T25 - T27 - T30 - T40 - T45 - T50 - T55

Item #
2218



Socket Set | 10 mm (3/8") drive | Inch sizes | 61 pcs.

10  3/8

- sockets in hexagon Pro torque® design
- 9 T-Star bit sockets (for Torx): T15 - T20 - T25 - T27 - T30 - T40 - T45 - T50 - T55
- 3 PH cross slot bit sockets: PH1 - PH2 - PH3
- 3 PZ cross slot bit sockets: PZ1 - PZ2 - PZ3
- 3 slotted bit sockets: 7/32" - 9/32" - 5/16"
- 7 bit sockets internal hexagon: 1/8" - 3/16" - 7/32" - 1/4" - 9/32" - 5/16" - 3/8"
- 18 sockets, Pro torque®, hexagon: 1/4" up to 15/16"
- 10 sockets, Pro torque®, hexagon, deep: 5/16" up to 3/4"
- 2 spark plug wrenches 16 + 21 mm
- 1 universal joint, 10 mm (3/8")
- 1 sliding bar/extension bar 250 mm
- 1 "wobble" extension bar 75 mm
- 1 reversible ratchet, fine 72 teeth
- 1 adaptor external square 10 mm (3/8") external hexagon 8 mm

Item #
2215



Socket Set | 10 mm (3/8") drive | 26 pcs.

10  3/8

- "Super Lock" sockets / wave profile model
- 18 "Super Lock" sockets, 10 mm (3/8") drive: 6 - 7 - 8 - 9 - 10 - 11 - 12 - 13 - 14 - 15 - 16 - 17 - 18 - 19 - 20 - 21 - 22 - 24 mm
- 3 wobble extension bars with external hexagon and knurling, length: 45 - 75 - 150 mm
- 2 spark plug wrenches, hexagon, 16 & 21 mm
- 1 universal joint, length: 50 mm
- reversible ratchet, fine gearing, length: 225 mm
- sliding adaptor for extension bars

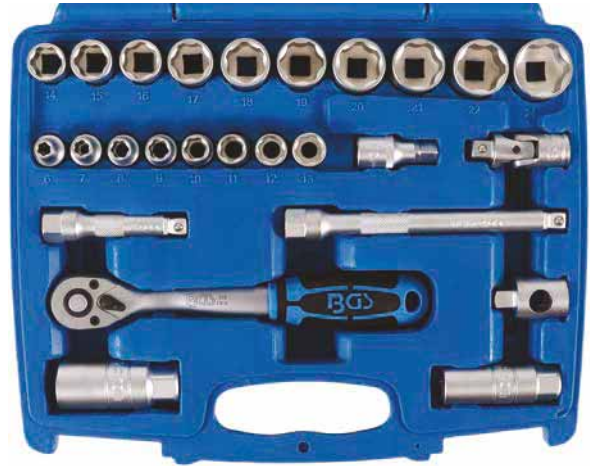

Item #
2227



Push-through Bit and Socket Set | 44 pcs.

- especially suitable for screw connections with long thread overhang, e.g. threaded rods
- no limited depth like "normal" sockets
- length of sockets and bits: 25.5 mm
- material: chromium vanadium steel (sockets) and chromium vanadium steel S2 (bits)
- push-through reversible ratchet, 72 teeth, 12 mm internal diameter
- 6-pt. push through sockets special 12 mm drive , 6-7-8-9-10-11-12-13-14 mm
- 33 special profile bits made of chrome vanadium S2 steel, special 12 mm drive, suitable for spline (for XZN), spline (for RIBE), T-Star & T-Star tamperproof (for Torx) and internal hexagon
 - 6 spline (for XZN): M4-M5-M6-M8-M10-M12
 - 7 spline (for RIBE): M5-M6-M7-M8-M10-M12-M13
 - 7 T-Star (for Torx): T15-T20-T25-T27-T30-T40-T45
 - 7 T-Star tamperproof (for Torx): T15-T20-T25-T27-T30-T40-T45
 - 6 internal hexagon: 4-5-6-7-8-10 mm
- adaptor, 12 mm special drive to 10mm (3/8") external square



Item #
9366



Socket Set | 12.5 mm (1/2") drive | 8 - 32 mm | 27 pcs.

12.5 \square 1/2

- Sockets in hexagon Pro torque® design
- fine 72 tooth reversible ratchet
- 2 extension bars: 125 - 250 mm
- 1 adaptor for extension bars & sliding bars
- 1 universal joint
- 2 spark plug sockets 16 - 21 mm
- 20 sockets, Pro torque®, hexagon: 8 - 9 - 10 - 11 - 12 - 13 - 14 - 15 - 16 - 17 - 18 - 19 - 20 - 21 - 22 - 23 - 24 - 27 - 30 - 32 mm



Item #
2224



Socket Sets & Tool Assortments

Socket Set | 12.5 mm (1/2") | Inch sizes | 27 pcs.

12.5 \square 1/2

- Sockets in hexagon Pro torque® design
- 1 reversible ratchet, 72 teeth
- 2 "Wobble" extension bars 125 - 250 mm
- 1 adaptor for extension bars & sliding bars
- 2 glow plug sockets: 5/8" - 13/16"
- 20 sockets, Pro torque®, hexagon: 5/16" - 11/32" - 3/8" - 7/16" - 15/32" - 1/2" - 9/16" - 19/32" - 5/8" - 21/32" - 11/16" - 3/4" - 25/32" - 13/16" - 7/8" - 15/16" - 1" - 1.1/16" - 1.3/16" - 1.1/4"



Item #
2216



1/4" 3/8" 1/2"

Socket Set | 20 mm (3/4") drive | 21 pcs.

20  3/4

- sockets in hexagon Pro torque® design
- 16 Pro torque® sockets hexagon, 20 mm (3/4") drive: 19 - 21 - 22 - 23 - 24 - 26 - 27 - 30 - 32 - 34 - 36 - 38 - 41 - 46 - 48 - 50 mm
- 1 reversible ratchet 500 mm with quick release button, black finish head
- 3 extension bars: 100 - 200 - 400 mm
- 1 sliding bar 450 mm



Item #	
1207	

Socket Set, 12-point | 20 mm (3/4") drive | 21 pcs.

20  3/4

- 12-point sockets, 20 mm (3/4") drive: 19 - 21 - 22 - 23 - 24 - 26 - 27 - 30 - 32 - 34 - 36 - 38 - 41 - 46 - 48 - 50 mm
- extension bars 100 - 200 - 410 mm
- reversible ratchet, 500 mm
- sliding bar, 455 mm

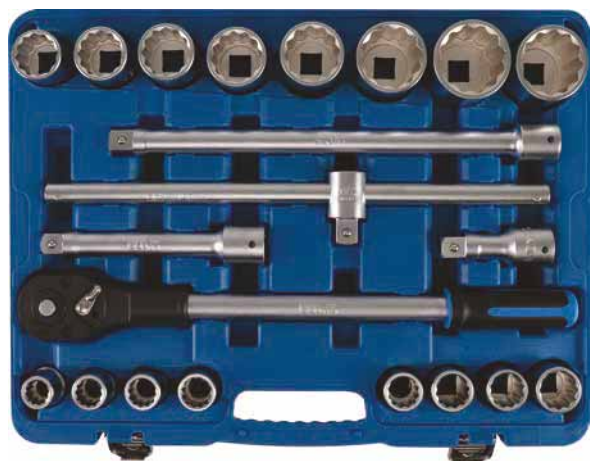

Item #	
1223	

Impact Socket Set | 20 mm (3/4") drive | 21 pcs.

20  3/4

- for both manual and impact use
- can be fixed on impact wrench by pin and O-ring
- sliding T-bar, length 450 mm
- reversible ratchet with quick release, length: 505 mm
- extension bars in 105 and 250 mm
- universal joint 105 mm
- Impact sockets, hexagon, 20 mm (3/4") drive: 19 - 21 - 22 - 23 - 24 - 26 - 27 - 29 - 32 - 35 - 36 - 38 - 41 - 46 - 50 mm



Item #	
5258	

Socket Set | 20 mm (3/4") | Inch sizes | 21 pcs.

20  3/4

- 16 12-point sockets: 7/8" - 15/16" - 1" - 1.1/16" - 1.1/8" - 1.3/16" - 1.1/4" - 1.5/16" - 1.3/8" - 1.7/16" - 1.1/2" - 1.5/8" - 1.3/4" - 1.13/16" - 1.7/8" - 2"
- 1 reversible ratchet with quick release button, black finish head
- 3 extension bars: 100 - 200 - 400 mm
- 1 sliding bar 450 mm



Socket Set | 20 mm (3/4") drive | 14 pcs.

20  3/4

- 10 sockets, socket internal square 20 mm (3/4"), hexagon: 22 - 24 - 27 - 30 - 32 - 36 - 38 - 41 - 46 - 50 mm
- 1 reversible ratchet 500 mm
- 1 sliding bar 450 mm
- 2 extension bars 100 - 200 mm
- surface finish: satin chrome plated



Socket Set | 25 mm (1") drive | 15 pcs.

25  1

- especially for use in farming and heavy duty
- reversible ratchet 24 teeth, length: 680 mm
- 2 extension bars: 200 - 400 mm
- with 500 mm long sliding tee bar incl. adaptor for loosening stuck nuts
- 10 hexagon sockets, socket internal square 25 mm (1"): 36 - 41 - 46 - 50 - 55 - 60 - 65 - 70 - 75 - 80 mm

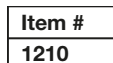

Socket Set Hexagon | 213 pcs.

6.3mm □ 1/4"

10mm □ 3/8"

12.5mm □ 1/2"

Item #
2259

CV

CV-S2
100%



Socket Sets & Tool Assortments

Set Contents

Item #	Description
291	Bit Adaptor with retaining Ball 10 mm (3/8") Drive - internal Hexagon 10 mm (3/8")
292	Bit Adaptor with retaining Ball 10 mm (3/8") Drive - internal Hexagon 8 mm (5/16")
290	Bit Adaptor with retaining Ball 12.5 mm (1/2") Drive - internal Hexagon 10 mm (3/8")
284	Bit Adaptor with retaining Ball 12.5 mm (1/2") Drive internal Hexagon 14 mm
8213	Bit Adaptor with retaining Ball internal Square 6.3 mm (1/4") internal Hexagon 6.3 mm (1/4")
216	Spinner Handle external Square 6.3 mm (1/4") 150 mm
276	Sliding Handle external Square 6.3 mm (1/4")



289	Sliding Adaptor for Extension Bars external Square 12.5 mm (1/2")
299	Universal Joint 10 mm (3/8")
251	Universal Joint 12.5 mm (1/2")
250	Universal Joint 6.3 mm (1/4")
246	„Wobble“ Extension Bar 10 mm (3/8") 125 mm
234	„Wobble“ Extension Bar 12.5 mm (1/2") 125 mm
235	„Wobble“ Extension Bar 12.5 mm (1/2") 250 mm
2232	„Wobble“ Extension Bar 6.3 mm (1/4") 50 mm
319	Reversible Ratchet fine gearing 10 mm (3/8")
320	Reversible Ratchet fine gearing 12.5 mm (1/2")
318	Reversible Ratchet fine gearing 6.3 mm (1/4")
2335	Extension Bar 6.3 mm (1/4") 100 mm

Socket Set Hexagon | 213 pcs.

6.3_m □ 1/4"

10_m □ 3/8"



12.5_m □ 1/2"

12.5_m □ 1/2"  



Item #	Size
2910	10 mm
2911	11 mm
2912	12 mm
2913	13 mm
2914	14 mm
2915	15 mm
2916	16 mm
2917	17 mm
2918	18 mm
2919	19 mm
2920	20 mm
2921	21 mm
2922	22 mm
2924	24 mm
2927	27 mm
2930	30 mm
2932	32 mm

12.5_m □ 1/2"  

Item #	Size
10556	16 mm
10557	17 mm
10558	18 mm
10559	19 mm
10562	22 mm

12.5_m □ 1/2"  



Item #	Size
6417	E18
6420	E20

10_m □ 3/8"  

Item #	Size
10610	10 mm
10611	11 mm
10612	12 mm
10613	13 mm
10614	14 mm
10615	15 mm
10616	16 mm
10617	17 mm
10618	18 mm
10619	19 mm

10_m □ 3/8"  

Item #	Size
10530	10 mm
10531	11 mm
10532	12 mm
10533	13 mm
10534	14 mm
10535	15 mm

10_m □ 3/8"  

Item #	Size
6410	E10
6411	E11
6412	E12
6414	E14
6416	E16
6417	E18

6.3_m □ 1/4"  

Item #	Size
2474	4 mm
2475	4.5 mm
2476	5 mm
2477	5.5 mm
2478	6 mm
2479	7 mm
2480	8 mm
2481	9 mm
2482	10 mm
2483	11 mm
2484	12 mm
2485	13 mm
2486	14 mm

6.3_m □ 1/4"  

Item #	Size
10504	4 mm
10505	5 mm
10506	6 mm
10507	7 mm
10508	8 mm
10509	9 mm
10510	10 mm

6.3_m □ 1/4"  

Item #	Size
6404	E4
6405	E5
6406	E6
6407	E7
6408	E8

12.5_m □ 1/2"  

Item #	Size
2472	16 mm
2464	18 mm
2470	21 mm



Item #	Size
30508	8 mm
30509	9 mm
30510	10 mm
30512	12 mm
30513	13 mm
30514	14 mm
30517	17 mm
30519	19 mm

12.5_m □ 1/2"  



Item #	Size
5184-R7	R 7 x 240 mm
5184-R8	R 8 x 240 mm
5184-R9	R 9 x 100 mm
5184-R10	R 10 x 140 mm
5184-TB30	T 30 x 300 mm
5184-T40	T 40 x 140 mm
5184-T45	T 45 x 140 mm
5184-T50	T 50 x 140 mm
5184-T55	T 55 x 140 mm
5184-T60	T 60 x 140 mm
5184-TB80	T 80 x 100 mm
5184-HB5	5 mm x 160 mm
5184-H7	7 mm x 230 mm
5184-H10	10 mm x 140 mm
5184-H11	11 mm x 140 mm
5184-H17	17 mm x 55 mm
5184-H19	19 mm x 55 mm
5184-H22	22 mm x 55 mm
5184-H24	24 mm x 55 mm
5184-M9	M 9 x 100 mm
5184-M10	M 10 x 140 mm
5184-M12	M 12 x 140 mm
4346	M 16 x 55 mm
4356	M 16 x 55 mm
4357	M 16 x 100 mm
4347	M 18 x 55 mm
5184-M18	M 18 x 80 mm

6.3_m □ 1/4"  



Item #	Size
2493	4.0 mm
2494	5.5 mm
2495	6.5 mm
2496	7.0 mm
2504	PH 0
2487	PH 1
2488	PH 2
2505	PZ 0
2490	PZ 1
2491	PZ 2
2497	3 mm
2498	4 mm
2499	5 mm
2500	6 mm
2589	T 8
2588	T 9
2590	T 10
2591	T 15
2592	T 20
2593	T 25
2594	T 27
2595	T 30
2356	T 8
2364	T 9
2357	T 10
2358	T 15
2359	T 20
2360	T 25
2361	T 27
2362	T 30

14_m  

Item #	Size
	T 70 x 30 mm
	T 70 x 30 mm
	T 70 x 115 mm
	M 14 x 115 mm
	M 14 x 40 mm
	13 x 115 mm
	14 x 30 mm

10_m  

Item #	Size
4955	10.0 mm
4956	12.0 mm
4875	T55
4876	T60
4655	T55
4660	T60

8_m  

Item #	Size
4380	8.0 mm
4381	10.0 mm
4382	12.0 mm
4383	PH 3
4384	PH 4
4385	PZ 3
4386	PZ 4
4387	7 mm
4388	8 mm
4440	T 40
4445	T 45
4450	T 50
8164	T 40
8165	T 45
8166	T 50

6.3_m  

Item #	Size
2625	T 5
2626	T 6
8217	T 7
2436	T 7
4680	TS 10
4681	TS 15
4682	TS 20
4683	TS 25
4684	TS 27
4685	TS 30
4686	TS 40
4687	TS 45
4688	TS 50
2635	M 5
2636	M 6
2637	M 7
2638	M 8
2639	M 9
2645	M 5
2646	M 6
	M 8

Socket Set Super Lock | 218 pcs.

6.3mm \square 1/4"

10mm \square 3/8"

12.5mm \square 1/2"

Socket Sets & Tool Assortments



Socket Set Super Lock | 218 pcs.

6.3_m 1/4" 10_m 3/8" 12.5_m 1/2"

Set Contents

Item #	Description
293	Bit Adaptor with retaining Ball 12.5 mm (1/2") Drive - internal Hexagon 8 mm (5/16")
292	Bit Adaptor with retaining Ball 10 mm (3/8") Drive - internal Hexagon 8 mm (5/16")
216	Spinner Handle external Square 6.3 mm (1/4") 150 nm
234	„Wobble“ Extension Bar 12.5 mm (1/2") 125 mm
3121	Extension Bar 12.5 mm (1/2") 250 mm
289	Sliding Adaptor for Extension Bars external Square 12.5 mm (1/2")
2232	„Wobble“ Extension Bar 6.3 mm (1/4") 50 mm
2335	Extension Bar 6.3 mm (1/4") 100 mm
246	„Wobble“ Extension Bar 10 mm (3/8") 125 mm
8213	Bit Adaptor with retaining Ball internal Square 6.3 mm (1/4") internal Hexagon 6.3 mm (1/4")
35100	L-Type Key Set extra long internal Hexagon/internal Hexagon with ball point 1.5 - 10 mm 9 pcs.
35105	L-Type Key Set T-Star (for Torx)/T-Star tamperproof (for Torx) T10 - T50 9 pcs.
250	Universal Joint 6.3 mm (1/4")
251	Universal Joint 12.5 mm (1/2")
299	Universal Joint 10 mm (3/8")
276	Sliding Handle External Square 6.3 mm (1/4")
318	Reversible Ratchet fine gearing 6.3 mm (1/4")
319	Reversible Ratchet fine gearing 10 mm (3/8")
320	Reversible Ratchet fine gearing 12.5 mm (1/2")



CV

Item #
8820

6.3_m 1/4"

Item #	Size
2493	⊖ 4.0 mm
2494	⊖ 5.5 mm
2495	⊖ 6.5 mm
2496	⊖ 7.0 mm
2504	⊕ PH 0
2487	⊕ PH 1
2488	⊕ PH 2
2505	⊕ PZ 0
2490	⊕ PZ 1
2491	⊕ PZ 2
2497	⊙ 3 mm
2498	⊙ 4 mm
2499	⊙ 5 mm
2500	⊙ 6 mm
2589	⊙ T 8
2588	⊙ T 9
2590	⊙ T 10
2591	⊙ T 15
2592	⊙ T 20
2593	⊙ T 25
2594	⊙ T 27
2595	⊙ T 30
2356	⊙ T 8
2364	⊙ T 9
2357	⊙ T 10
2358	⊙ T 15
2359	⊙ T 20
2360	⊙ T 25
2361	⊙ T 27
2362	⊙ T 30
2503	⊙ M 5
2506	⊙ M 6
2507	⊙ M 8

6.3_m 1/4"

Item #	Size
8185	⊕ PH 1
8186	⊕ PH 2
8170	⊕ PZ 1
8172	⊕ PZ 2
	⊙ T 5
	⊙ T 6
	⊙ T 7
8190	⊙ T 10
8191	⊙ T 15
8192	⊙ T 20
8193	⊙ T 25
8194	⊙ T 27
8195	⊙ T 30
8196	⊙ T 40
2436	⊙ T 7
2439	⊙ T 10
2440	⊙ T 15
2441	⊙ T 20
2442	⊙ T 25
2443	⊙ T 27
2444	⊙ T 30
2445	⊙ T 40
	⊙ TS 10
	⊙ TS 15
	⊙ TS 20
	⊙ TS 25
	⊙ TS 27
	⊙ TS 30
	⊙ TS 40
	⊙ TS 45
	⊙ M 5
	⊙ M 6
	⊙ M 7
	⊙ M 8
	⊙ M 9
	⊙ M 5
	⊙ M 6
	⊙ M 8
	⊙ 2 mm
	⊙ 2.5 mm

12.5_m 1/2"

Item #	Size
2410	10 mm
2411	11 mm
2412	12 mm
2413	13 mm
2414	14 mm
2415	15 mm
2416	16 mm
2417	17 mm
2418	18 mm
2419	19 mm
2420	20 mm
2421	21 mm
2422	22 mm
2424	24 mm
2427	27 mm
2430	30 mm
2432	32 mm

10_m 3/8"

Item #	Size
2370	10 mm
2371	11 mm
2372	12 mm
2373	13 mm
2374	14 mm
2375	15 mm
2376	16 mm
2377	17 mm
2378	18 mm
2379	19 mm

6.3_m 1/4"

Item #	Size
2344	4 mm
2339	4,5 mm
2345	5 mm
2343	5,5 mm
2346	6 mm
2347	7 mm
2348	8 mm
2349	9 mm
2350	10 mm
2351	11 mm
2352	12 mm
2353	13 mm
2354	14 mm

8_m 5/16"

Item #	Size
4380	⊖ 8.0 mm
4381	⊖ 10.0 mm
4382	⊖ 12.0 mm
4383	⊕ PH 3
4384	⊕ PH 4
4385	⊕ PZ 3
4386	⊕ PZ 4
4387	⊙ 7 mm
4388	⊙ 8 mm
4389	⊙ 10 mm
4390	⊙ 12 mm
4391	⊙ 14 mm
4440	⊙ T 40
4445	⊙ T 45
4450	⊙ T 50
4455	⊙ T 55
4460	⊙ T 60
4458	⊙ T 70
8164	⊙ T 40
8165	⊙ T 45
8166	⊙ T 50
8168	⊙ T 55
4456	⊙ T 60
4457	⊙ T 70

12.5_m 1/2"

Item #	Size
2946	16 mm
2948	18 mm

10_m 3/8"

Item #	Size
2600	10 mm
2601	11 mm
2602	12 mm
2603	13 mm
2604	14 mm
2605	15 mm

6.3_m 1/4"

Item #	Size
2964	4 mm
2965	5 mm
2966	6 mm
2967	7 mm
2968	8 mm
2969	9 mm
2970	10 mm

12.5_m 1/2"

Item #	Size
6420	E20
6424	E24

10_m 3/8"

Item #	Size
6410	E10
6411	E11
6412	E12
6414	E14
6416	E16
6417	E18

6.3_m 1/4"

Item #	Size
6404	E4
6405	E5
6406	E6
6407	E7
6408	E8

12.5_m 1/2" Impact Sockets Deep

Item #	Size
7201	17 mm
7202	19 mm
7203	21 mm

12.5_m 1/2"

Item #	Size
2472	16 mm
2464	18 mm
2470	21 mm



Item #	Size
	8 mm
	9 mm
	10 mm
	11 mm
	12 mm
	13 mm
	14 mm
	15 mm
	16 mm
	17 mm
	18 mm
	19 mm

Socket Set „Gear Lock“ | 218 pcs.

6.3mm \square 1/4"

10mm \square 3/8"

12.5mm \square 1/2"

Socket Sets & Tool Assortments



Socket Set „Gear Lock“ | 218 pcs.

6.3_m □ 1/4"

10_m □ 3/8"

12.5_m □ 1/2"

Set Contents

Item #	Description
293	Bit Adaptor with retaining Ball 12.5 mm (1/2") Drive - internal Hexagon 8 mm (5/16")
292	Bit Adaptor with retaining Ball 10 mm (3/8") Drive - internal Hexagon 8 mm (5/16")
216	Spinner Handle external Square 6.3 mm (1/4") 150 nm
234	„Wobble“ Extension Bar 12.5 mm (1/2") 125 mm
3121	Extension Bar 12.5 mm (1/2") 250 mm
289	Sliding Adaptor for Extension Bars external Square 12.5 mm (1/2")
2232	„Wobble“ Extension Bar 6.3 mm (1/4") 50 mm
2335	Extension Bar 6.3 mm (1/4") 100 mm
246	„Wobble“ Extension Bar 10 mm (3/8") 125 mm
8213	Bit Adaptor with retaining Ball internal Square 6.3 mm (1/4") internal Hexagon 6.3 mm (1/4")
35100	L-Type Key Set extra long internal Hexagon/internal Hexagon with ball point 1.5 - 10 mm 9 pcs.
35105	L-Type Key Set T-Star (for Torx)/T-Star tamperproof (for Torx) T10 - T50 9 pcs.
250	Universal Joint 6.3 mm (1/4")
251	Universal Joint 12.5 mm (1/2")
299	Universal Joint 10 mm (3/8")
276	Sliding Handle External Square 6.3 mm (1/4")
318	Reversible Ratchet fine gearing 6.3 mm (1/4")
319	Reversible Ratchet fine gearing 10 mm (3/8")
320	Reversible Ratchet fine gearing 12.5 mm (1/2")

6.3_m □ 1/4"



CV

Item #
2290

Item #	Size
2493	⊖ 4.0 mm
2494	⊖ 5.5 mm
2495	⊖ 6.5 mm
2496	⊖ 7.0 mm
2504	⊕ PH 0
2487	⊕ PH 1
2488	⊕ PH 2
2505	⊕ PZ 0
2490	⊕ PZ 1
2491	⊕ PZ 2
2497	⊙ 3 mm
2498	⊙ 4 mm
2499	⊙ 5 mm
2500	⊙ 6 mm
2589	⊙ T 8
2588	⊙ T 9
2590	⊙ T 10
2591	⊙ T 15
2592	⊙ T 20
2593	⊙ T 25
2594	⊙ T 27
2595	⊙ T 30
2356	⊙ T 8
2364	⊙ T 9
2357	⊙ T 10
2358	⊙ T 15
2359	⊙ T 20
2360	⊙ T 25
2361	⊙ T 27
2362	⊙ T 30
2503	⊙ M 5
2506	⊙ M 6
2507	⊙ M 8

6.3_m □ 1/4"

Item #	Size
8185	⊕ PH 1
8186	⊕ PH 2
8170	⊕ PZ 1
8172	⊕ PZ 2
	⊙ T 5
	⊙ T 6
	⊙ T 7
8190	⊙ T 10
8191	⊙ T 15
8192	⊙ T 20
8193	⊙ T 25
8194	⊙ T 27
8195	⊙ T 30
8196	⊙ T 40
2436	⊙ T 7
2439	⊙ T 10
2440	⊙ T 15
2441	⊙ T 20
2442	⊙ T 25
2443	⊙ T 27
2444	⊙ T 30
2445	⊙ T 40
	⊙ TS 10
	⊙ TS 15
	⊙ TS 20
	⊙ TS 25
	⊙ TS 27
	⊙ TS 30
	⊙ TS 40
	⊙ TS 45
	⊙ M 5
	⊙ M 6
	⊙ M 7
	⊙ M 8
	⊙ M 9
	⊙ M 5
	⊙ M 6
	⊙ M 8
	⊙ 2 mm
	⊙ 2.5 mm

12.5_m □ 1/2"



10_m □ 3/8"



6.3_m □ 1/4"



Item #	Size
10210	10 mm
10211	11 mm
10212	12 mm
10213	13 mm
10214	14 mm
10215	15 mm
10216	16 mm
10217	17 mm
10218	18 mm
10219	19 mm
10220	20 mm
10221	21 mm
10222	22 mm
10224	24 mm
10227	27 mm
10230	30 mm
10232	32 mm

Item #	Size
10310	10 mm
10311	11 mm
10312	12 mm
10313	13 mm
10314	14 mm
10315	15 mm
10316	16 mm
10317	17 mm
10318	18 mm
10319	19 mm

Item #	Size
10104	4 mm
10101	4.5 mm
10105	5 mm
10102	5.5 mm
10106	6 mm
10107	7 mm
10108	8 mm
10109	9 mm
10110	10 mm
10111	11 mm
10112	12 mm
10113	13 mm
10114	14 mm

12.5_m □ 1/2"



10_m □ 3/8"



6.3_m □ 1/4"



Item #	Size
10256	16 mm
10258	18 mm

Item #	Size
10350	10 mm
10351	11 mm
10352	12 mm
10353	13 mm
10354	14 mm
10355	15 mm

Item #	Size
10154	4 mm
10155	5 mm
10156	6 mm
10157	7 mm
10158	8 mm
10159	9 mm
10160	10 mm

12.5_m □ 1/2"



10_m □ 3/8"



6.3_m □ 1/4"



Item #	Size
6420	E20
6424	E24

Item #	Size
6410	E10
6411	E11
6412	E12
6414	E14
6416	E16
6417	E18

Item #	Size
6404	E4
6405	E5
6406	E6
6407	E7
6408	E8

12.5_m □ 1/2"

Impact
Sockets Deep



12.5_m □ 1/2"



Item #	Size
7201	17 mm
7202	19 mm
7203	21 mm

Item #	Size
2472	16 mm
2464	18 mm
2470	21 mm

8_m □ 5/16"



Item #	Size
4380	⊖ 8.0 mm
4381	⊖ 10.0 mm
4382	⊖ 12.0 mm
4383	⊕ PH 3
4384	⊕ PH 4
4385	⊕ PZ 3
4386	⊕ PZ 4
4387	⊙ 7 mm
4388	⊙ 8 mm
4389	⊙ 10 mm
4390	⊙ 12 mm
4391	⊙ 14 mm
4440	⊙ T 40
4445	⊙ T 45
4450	⊙ T 50
4455	⊙ T 55
4460	⊙ T 60
4458	⊙ T 70
8164	⊙ T 40
8165	⊙ T 45
8166	⊙ T 50
8168	⊙ T 55
4456	⊙ T 60
4457	⊙ T 70



Item #	Size
	8 mm
	9 mm
	10 mm
	11 mm
	12 mm
	13 mm
	14 mm
	15 mm
	16 mm
	17 mm
	18 mm
	19 mm

Socket Set Super Lock | 192 pcs.

6.3mm □ 1/4"

10mm □ 3/8"

12.5mm □ 1/2"

Socket Sets & Tool Assortments



Socket Set Super Lock | 192 pcs.

6.3_m □ 1/4"

10_m □ 3/8"

12.5_m □ 1/2"



CV

Item #
2292

Set Contents

Item #	Description
293	Bit Adaptor with retaining Ball 12.5 mm (1/2") Drive - internal Hexagon 8 mm (5/16")
292	Bit Adaptor with retaining Ball 10 mm (3/8") Drive - internal Hexagon 8 mm (5/16")
216	Spinner Handle external Square 6.3 mm (1/4") 150 mm
234	„Wobble“ Extension Bar 12.5 mm (1/2") 125 mm
235	„Wobble“ Extension Bar 12.5 mm (1/2") 250 mm
289	Sliding Adaptor for Extension Bars external Square 12.5 mm (1/2")
2232	„Wobble“ Extension Bar 6.3 mm (1/4") 50 mm
2335	Extension Bar 6.3 mm (1/4") 100 mm
246	„Wobble“ Extension Bar 10 mm (3/8") 125 mm
	Internal Hexagon L-Type Key Set, 1 - 1,5 - 2 - 2,5 - 3 - 4 - 5 mm
8213	Bit Adaptor with retaining Ball internal Square 6.3 mm (1/4") internal Hexagon 6.3 mm (1/4")
250	Universal Joint 6.3 mm (1/4")
251	Universal Joint 12.5 mm (1/2")
299	Universal Joint 10 mm (3/8")
276	Sliding Handle External Square 6.3 mm (1/4")
318	Reversible Ratchet fine gearing 6.3 mm (1/4")
319	Reversible Ratchet fine gearing 10 mm (3/8")
320	Reversible Ratchet fine gearing 12.5 mm (1/2")

6.3_m □ 1/4"

Item #	Size
2493	⊖ 4.0 mm
2494	⊖ 5.5 mm
2495	⊖ 6.5 mm
2496	⊖ 7.0 mm
2504	⊕ PH 0
2487	⊕ PH 1
2488	⊕ PH 2
2505	⊕ PZ 0
2490	⊕ PZ 1
2491	⊕ PZ 2
2497	● 3 mm
2498	● 4 mm
2499	● 5 mm
2500	● 6 mm
2589	⊗ T 8
2588	⊗ T 9
2590	⊗ T 10
2591	⊗ T 15
2592	⊗ T 20
2593	⊗ T 25
2594	⊗ T 27
2595	⊗ T 30
2356	⊗ T 8
2364	⊗ T 9
2357	⊗ T 10
2358	⊗ T 15
2359	⊗ T 20
2360	⊗ T 25
2361	⊗ T 27
2362	⊗ T 30

6.3_m □ 1/4"

Item #	Size
8185	⊕ PH 1
8186	⊕ PH 2
8170	⊕ PZ 1
8172	⊕ PZ 2
	⊗ T 5
	⊗ T 6
	⊗ T 7
8190	⊗ T 10
8191	⊗ T 15
8192	⊗ T 20
8193	⊗ T 25
8194	⊗ T 27
8195	⊗ T 30
8196	⊗ T 40
2436	⊗ T 7
2439	⊗ T 10
2440	⊗ T 15
2441	⊗ T 20
2442	⊗ T 25
2443	⊗ T 27
2444	⊗ T 30
2445	⊗ T 40
	⊗ TS 10
	⊗ TS 15
	⊗ TS 20
	⊗ TS 25
	⊗ TS 27
	⊗ TS 30
	⊗ TS 40
	⊗ TS 45
	● M 5
	● M 6
	● M 7
	● M 8
	● M 9
	● M 5
	● M 6
	● M 8
4456	⊗ T 60
4457	⊗ T 70
	● 2 mm
	● 2.5 mm

12.5_m □ 1/2"

Item #	Size
2410	10 mm
2411	11 mm
2412	12 mm
2413	13 mm
2414	14 mm
2415	15 mm
2416	16 mm
2417	17 mm
2418	18 mm
2419	19 mm
2420	20 mm
2421	21 mm
2422	22 mm
2424	24 mm
2427	27 mm
2430	30 mm
2432	32 mm

10_m □ 3/8"

Item #	Size
2370	10 mm
2371	11 mm
2372	12 mm
2373	13 mm
2374	14 mm
2375	15 mm
2376	16 mm
2377	17 mm
2378	18 mm
2379	19 mm

6.3_m □ 1/4"

Item #	Size
2344	4 mm
2339	4.5 mm
2345	5 mm
2343	5.5 mm
2346	6 mm
2347	7 mm
2348	8 mm
2349	9 mm
2350	10 mm
2351	11 mm
2352	12 mm
2353	13 mm
2354	14 mm

8_m □ 5/16"

Item #	Size
4380	⊖ 8.0 mm
4381	⊖ 10.0 mm
4382	⊖ 12.0 mm
4383	⊕ PH 3
4384	⊕ PH 4
4385	⊕ PZ 3
4386	⊕ PZ 4
4387	● 7 mm
4388	● 8 mm
4389	● 10 mm
4390	● 12 mm
4391	● 14 mm
4440	⊗ T 40
4445	⊗ T 45
4450	⊗ T 50
4455	⊗ T 55
4460	⊗ T 60
4458	⊗ T 70
8164	⊗ T 40
8165	⊗ T 45
8166	⊗ T 50
8168	⊗ T 55

12.5_m □ 1/2"

Item #	Size
2946	16 mm
2947	17 mm
2948	18 mm
2949	19 mm
2952	22 mm

10_m □ 3/8"

Item #	Size
2600	10 mm
2601	11 mm
2602	12 mm
2603	13 mm
2604	14 mm
2605	15 mm

6.3_m □ 1/4"

Item #	Size
2964	4 mm
2965	5 mm
2966	6 mm
2967	7 mm
2968	8 mm
2969	9 mm
2970	10 mm

12.5_m □ 1/2"

Item #	Size
6420	E20
6424	E24

12.5_m □ 1/2"

Item #	Size
6410	E10
6411	E11
6412	E12
6414	E14
6416	E16
6417	E18
2472	16 mm, 12.5 mm (1/2")
2464	18 mm, 10 mm (3/8")
2470	21 mm, 12.5 mm (1/2")

6.3_m □ 1/4"

Item #	Size
6404	E4
6405	E5
6406	E6
6407	E7
6408	E8

Socket Set Hexagon | 192 pcs.

6.3mm □ 1/4"

10mm □ 3/8"

12.5mm □ 1/2"

Socket Sets & Tool Assortments



Socket Set Hexagon | 192 pcs.

6.3_m □ 1/4"

10_m □ 3/8"

12.5_m □ 1/2"



CV

Item #
2243

Set Contents

Item #	Description
293	Bit Adaptor with retaining Ball 12.5 mm (1/2") Drive - internal Hexagon 8 mm (5/16")
292	Bit Adaptor with retaining Ball 10 mm (3/8") Drive - internal Hexagon 8 mm (5/16")
216	Spinner Handle external Square 6.3 mm (1/4") 150 mm
234	„Wobble“ Extension Bar 12.5 mm (1/2") 125 mm
235	„Wobble“ Extension Bar 12.5 mm (1/2") 250 mm
289	Sliding Adaptor for Extension Bars external Square 12.5 mm (1/2")
2232	„Wobble“ Extension Bar 6.3 mm (1/4") 50 mm
2335	Extension Bar 6.3 mm (1/4") 100 mm
246	„Wobble“ Extension Bar 10 mm (3/8") 125 mm
Internal Hexagon L-Type Key Set, 1 - 1,5 - 2 - 2,5 - 3 - 4 - 5 mm	
8213	Bit Adaptor with retaining Ball internal Square 6.3 mm (1/4") internal Hexagon 6.3 mm (1/4")
250	Universal Joint 6.3 mm (1/4")
251	Universal Joint 12.5 mm (1/2")
299	Universal Joint 10 mm (3/8")
276	Sliding Handle External Square 6.3 mm (1/4")
318	Reversible Ratchet fine gearing 6.3 mm (1/4")
319	Reversible Ratchet fine gearing 10 mm (3/8")
320	Reversible Ratchet fine gearing 12.5 mm (1/2")

6.3_m □ 1/4"

Item #	Size
2493	⊖ 4.0 mm
2494	⊖ 5.5 mm
2495	⊖ 6.5 mm
2496	⊖ 7.0 mm
2504	⊕ PH 0
2487	⊕ PH 1
2488	⊕ PH 2
2505	⊕ PZ 0
2490	⊕ PZ 1
2491	⊕ PZ 2
2497	● 3 mm
2498	● 4 mm
2499	● 5 mm
2500	● 6 mm
2589	⊗ T 8
2588	⊗ T 9
2590	⊗ T 10
2591	⊗ T 15
2592	⊗ T 20
2593	⊗ T 25
2594	⊗ T 27
2595	⊗ T 30
2356	⊗ T 8
2364	⊗ T 9
2357	⊗ T 10
2358	⊗ T 15
2359	⊗ T 20
2360	⊗ T 25
2361	⊗ T 27
2362	⊗ T 30

6.3_m □ 1/4"

Item #	Size
8185	⊕ PH 1
8186	⊕ PH 2
8170	⊕ PZ 1
8172	⊕ PZ 2
	⊗ T 5
	⊗ T 6
	⊗ T 7
8190	⊗ T 10
8191	⊗ T 15
8192	⊗ T 20
8193	⊗ T 25
8194	⊗ T 27
8195	⊗ T 30
8196	⊗ T 40
2436	⊗ T 7
2439	⊗ T 10
2440	⊗ T 15
2441	⊗ T 20
2442	⊗ T 25
2443	⊗ T 27
2444	⊗ T 30
2445	⊗ T 40
	⊗ TS 10
	⊗ TS 15
	⊗ TS 20
	⊗ TS 25
	⊗ TS 27
	⊗ TS 30
	⊗ TS 40
	⊗ TS 45
	● M 5
	● M 6
	● M 7
	● M 8
	● M 9
	● M 5
	● M 6
	● M 8
	● 2 mm
	● 2.5 mm

12.5_m □ 1/2"

Item #	Size
2910	10 mm
2911	11 mm
2912	12 mm
2913	13 mm
2914	14 mm
2915	15 mm
2916	16 mm
2917	17 mm
2918	18 mm
2919	19 mm
2920	20 mm
2921	21 mm
2922	22 mm
2924	24 mm
2927	27 mm
2930	30 mm
2932	32 mm

10_m □ 3/8"

Item #	Size
10610	10 mm
10611	11 mm
10612	12 mm
10613	13 mm
10614	14 mm
10615	15 mm
10616	16 mm
10617	17 mm
10618	18 mm
10619	19 mm

6.3_m □ 1/4"

Item #	Size
2474	4 mm
2475	4.5 mm
2476	5 mm
2477	5.5 mm
2478	6 mm
2479	7 mm
2480	8 mm
2481	9 mm
2482	10 mm
2483	11 mm
2484	12 mm
2485	13 mm
2486	14 mm

10_m □ 3/8"

Item #	Size
10530	10 mm
10531	11 mm
10532	12 mm
10533	13 mm
10534	14 mm
10535	15 mm

6.3_m □ 1/4"

Item #	Size
10504	4 mm
10505	5 mm
10506	6 mm
10507	7 mm
10508	8 mm
10509	9 mm
10510	10 mm

12.5_m □ 1/2"

Item #	Size
10556	16 mm
10557	17 mm
10558	18 mm
10559	19 mm
10562	22 mm

10_m □ 3/8"

Item #	Size
6410	E10
6411	E11
6412	E12
6414	E14
6416	E16
6417	E18

6.3_m □ 1/4"

Item #	Size
6404	E4
6405	E5
6406	E6
6407	E7
6408	E8

12.5_m □ 1/2"

Item #	Size
6420	E20
6424	E24

12.5_m □ 1/2"

Item #	Size
2472	16 mm, 12.5 mm (1/2")
2464	18 mm, 10 mm (3/8")
2470	21 mm, 12.5 mm (1/2")

Socket Set „Gear Lock“ | 192 pcs.

6.3mm \square 1/4"

10mm \square 3/8"

12.5mm \square 1/2"

Socket Sets & Tool Assortments



Socket Set „Gear Lock“ | 192 pcs.

6.3_m □ 1/4"

10_m □ 3/8"

12.5_m □ 1/2"



CV

Item #
2247

Set Contents

Item #	Description
293	Bit Adaptor with retaining Ball 12.5 mm (1/2") Drive - internal Hexagon 8 mm (5/16")
292	Bit Adaptor with retaining Ball 10 mm (3/8") Drive - internal Hexagon 8 mm (5/16")
216	Spinner Handle external Square 6.3 mm (1/4") 150 mm
234	„Wobble“ Extension Bar 12.5 mm (1/2") 125 mm
235	„Wobble“ Extension Bar 12.5 mm (1/2") 250 mm
289	Sliding Adaptor for Extension Bars external Square 12.5 mm (1/2")
2232	„Wobble“ Extension Bar 6.3 mm (1/4") 50 mm
2335	Extension Bar 6.3 mm (1/4") 100 mm
246	„Wobble“ Extension Bar 10 mm (3/8") 125 mm
	Internal Hexagon L-Type Key Set, 1 - 1,5 - 2 - 2,5 - 3 - 4 - 5 mm
8213	Bit Adaptor with retaining Ball internal Square 6.3 mm (1/4") internal Hexagon 6.3 mm (1/4")
250	Universal Joint 6.3 mm (1/4")
251	Universal Joint 12.5 mm (1/2")
299	Universal Joint 10 mm (3/8")
276	Sliding Handle External Square 6.3 mm (1/4")
318	Reversible Ratchet fine gearing 6.3 mm (1/4")
319	Reversible Ratchet fine gearing 10 mm (3/8")
320	Reversible Ratchet fine gearing 12.5 mm (1/2")

6.3_m □ 1/4"

Item #	Size
2493	⊖ 4.0 mm
2494	⊖ 5.5 mm
2495	⊖ 6.5 mm
2496	⊖ 7.0 mm
2504	⊕ PH 0
2487	⊕ PH 1
2488	⊕ PH 2
2505	⊕ PZ 0
2490	⊕ PZ 1
2491	⊕ PZ 2
2497	● 3 mm
2498	● 4 mm
2499	● 5 mm
2500	● 6 mm
2589	⊗ T 8
2588	⊗ T 9
2590	⊗ T 10
2591	⊗ T 15
2592	⊗ T 20
2593	⊗ T 25
2594	⊗ T 27
2595	⊗ T 30
2356	⊗ T 8
2364	⊗ T 9
2357	⊗ T 10
2358	⊗ T 15
2359	⊗ T 20
2360	⊗ T 25
2361	⊗ T 27
2362	⊗ T 30

6.3_m □ 1/4"

Item #	Size
8185	⊕ PH 1
8186	⊕ PH 2
8170	⊕ PZ 1
8172	⊕ PZ 2
	⊗ T 5
	⊗ T 6
	⊗ T 7
8190	⊗ T 10
8191	⊗ T 15
8192	⊗ T 20
8193	⊗ T 25
8194	⊗ T 27
8195	⊗ T 30
8196	⊗ T 40
2436	⊗ T 7
2439	⊗ T 10
2440	⊗ T 15
2441	⊗ T 20
2442	⊗ T 25
2443	⊗ T 27
2444	⊗ T 30
2445	⊗ T 40
	⊗ TS 10
	⊗ TS 15
	⊗ TS 20
	⊗ TS 25
	⊗ TS 27
	⊗ TS 30
	⊗ TS 40
	⊗ TS 45
	● M 5
	● M 6
	● M 7
	● M 8
	● M 9
	● M 5
	● M 6
	● M 8
4456	● T 60
4457	● T 70

12.5_m □ 1/2"

Item #	Size
10210	10 mm
10211	11 mm
10212	12 mm
10213	13 mm
10214	14 mm
10215	15 mm
10216	16 mm
10217	17 mm
10218	18 mm
10219	19 mm
10220	20 mm
10221	21 mm
10222	22 mm
10224	24 mm
10227	27 mm
10230	30 mm
10232	32 mm

10_m □ 3/8"

Item #	Size
10310	10 mm
10311	11 mm
10312	12 mm
10313	13 mm
10314	14 mm
10315	15 mm
10316	16 mm
10317	17 mm
10318	18 mm
10319	19 mm

6.3_m □ 1/4"

Item #	Size
10104	4 mm
10101	4.5 mm
10105	5 mm
10102	5.5 mm
10106	6 mm
10107	7 mm
10108	8 mm
10109	9 mm
10110	10 mm
10111	11 mm
10112	12 mm
10113	13 mm
10114	14 mm

10_m □ 3/8"

Item #	Size
10350	10 mm
10351	11 mm
10352	12 mm
10353	13 mm
10354	14 mm
10355	15 mm

6.3_m □ 1/4"

Item #	Size
10154	4 mm
10155	5 mm
10156	6 mm
10157	7 mm
10158	8 mm
10159	9 mm
10160	10 mm

12.5_m □ 1/2"

Item #	Size
10256	16 mm
10257	17 mm
10258	18 mm
10259	19 mm
	22 mm

10_m □ 3/8"

Item #	Size
6410	E10
6411	E11
6412	E12
6414	E14
6416	E16
6417	E18

6.3_m □ 1/4"

Item #	Size
6404	E4
6405	E5
6406	E6
6407	E7
6408	E8

12.5_m □ 1/2"

Item #	Size
6420	E20
6424	E24

12.5_m □ 1/2"

Item #	Size
2472	16 mm, 12.5 mm (1/2")
2464	18 mm, 10 mm (3/8")
2470	21 mm, 12.5 mm (1/2")

Socket Set Hexagon | Inch Sizes | 192 pcs.

6.3mm \square 1/4" 10mm \square 3/8" 12.5mm \square 1/2"

Socket Sets & Tool Assortments



Socket Set Hexagon | Inch Sizes | 192 pcs.

6.3_m □ 1/4" 10_m □ 3/8" 12.5_m □ 1/2"



Item #
2245

Set Contents

Item #	Description
293	Bit Adaptor with retaining Ball 12.5 mm (1/2") Drive - internal Hexagon 8 mm (5/16")
292	Bit Adaptor with retaining Ball 10 mm (3/8") Drive - internal Hexagon 8 mm (5/16")
216	Spinner Handle external Square 6.3 mm (1/4") 150 mm
234	„Wobble“ Extension Bar 12.5 mm (1/2") 125 mm
235	„Wobble“ Extension Bar 12.5 mm (1/2") 250 mm
289	Sliding Adaptor for Extension Bars external Square 12.5 mm (1/2")
2232	„Wobble“ Extension Bar 6.3 mm (1/4") 50 mm
2335	Extension Bar 6.3 mm (1/4") 100 mm
246	„Wobble“ Extension Bar 10 mm (3/8") 125 mm
	Internal Hexagon L-Type Key Set, 1 - 1,5 - 2 - 2,5 - 3 - 4 - 5 mm
8213	Bit Adaptor with retaining Ball internal Square 6.3 mm (1/4") internal Hexagon 6.3 mm (1/4")
250	Universal Joint 6.3 mm (1/4")
251	Universal Joint 12.5 mm (1/2")
299	Universal Joint 10 mm (3/8")
276	Sliding Handle external Square 6.3 mm (1/4")
318	Reversible Ratchet fine gearing 6.3 mm (1/4")
319	Reversible Ratchet fine gearing 10 mm (3/8")
320	Reversible Ratchet fine gearing 12.5 mm (1/2")

6.3_m □ 1/4"

Item #	Size
2493	⊖ 4.0 mm
2494	⊖ 5.5 mm
2495	⊖ 6.5 mm
2496	⊖ 7.0 mm
2504	⊕ PH 0
2487	⊕ PH 1
2488	⊕ PH 2
2505	⊕ PZ 0
2490	⊕ PZ 1
2491	⊕ PZ 2
2742	● 5/32"
2743	● 3/16"
2744	● 7/32"
2745	● 1/4"
2589	⊗ T 8
2588	⊗ T 9
2590	⊗ T 10
2591	⊗ T 15
2592	⊗ T 20
2593	⊗ T 25
2594	⊗ T 27
2595	⊗ T 30
2356	⊗ T 8
2364	⊗ T 9
2357	⊗ T 10
2358	⊗ T 15
2359	⊗ T 20
2360	⊗ T 25
2361	⊗ T 27
2362	⊗ T 30

6.3_m □ 1/4"

Item #	Size
8185	⊕ PH 1
8186	⊕ PH 2
8170	⊕ PZ 1
8172	⊕ PZ 2
	⊗ T 5
	⊗ T 6
	⊗ T 7
8190	⊗ T 10
8191	⊗ T 15
8192	⊗ T 20
8193	⊗ T 25
8194	⊗ T 27
8195	⊗ T 30
8196	⊗ T 40
2436	⊗ T 7
2439	⊗ T 10
2440	⊗ T 15
2441	⊗ T 20
2442	⊗ T 25
2443	⊗ T 27
2444	⊗ T 30
2445	⊗ T 40
	⊗ TS 10
	⊗ TS 15
	⊗ TS 20
	⊗ TS 25
	⊗ TS 27
	⊗ TS 30
	⊗ TS 40
	⊗ TS 45
	⊗ M 5
	⊗ M 6
	⊗ M 7
	⊗ M 8
	⊗ M 9
	⊗ M 5
	⊗ M 6
	⊗ M 8
4456	⊗ T 60
4457	⊗ T 70
	● 2 mm
	● 2.5 mm

12.5_m □ 1/2"

Item #	Size
2770	3/8"
2771	7/16"
2780	15/32"
2772	1/2"
2773	9/16"
	19/32"
2774	5/8"
	21/32"
2775	11/16"
2776	3/4"
	25/32"
2777	13/16"
2778	7/8"
2779	15/16"
2784	1-1/16"
	1-3/16"
2786	1-1/4"

10_m □ 3/8"

Item #	Size
	3/8"
	7/16"
	15/32"
	1/2"
	9/16"
	19/32"
	5/8"
	11/16"
	3/4"
	25/32"

6.3_m □ 1/4"

Item #	Size
10650	5/32"
10651	3/16"
10652	7/32"
10653	1/4"
10654	9/32"
10655	5/16"
10656	11/32"
10657	3/8"
10658	7/16"
	15/32"
10659	1/2"
	9/16"

10_m □ 3/8"

Item #	Size
	3/8"
	7/16"
	15/32"
	1/2"
	9/16"
	19/32"

6.3_m □ 1/4"

Item #	Size
	5/32"
	3/16"
10670	1/4"
	9/32"
10671	5/16"
	11/32"
10672	3/8"

12.5_m □ 1/2"

Item #	Size
10752	5/8"
	11/16"
	3/4"
	13/16"
	7/8"

10_m □ 3/8"

Item #	Size
6410	E10
6411	E11
6412	E12
6414	E14
6416	E16
6417	E18

6.3_m □ 1/4"

Item #	Size
6404	E4
6405	E5
6406	E6
6407	E7
6408	E8

12.5_m □ 1/2"

Item #	Size
6420	E20
6424	E24

12.5_m □ 1/2"

Item #	Size
2472	16 mm, 12.5 mm (1/2")
2464	18 mm, 10 mm (3/8")
2470	21 mm, 12.5 mm (1/2")

Socket Set 12-point | 192 pcs.

6.3mm \square 1/4"

10mm \square 3/8"

12.5mm \square 1/2"

Socket Sets & Tool Assortments



Socket Set 12-point | 192 pcs.

6.3_m 1/4" 10_m 3/8" 12.5_m 1/2"



Set Contents

Item #	Description
293	Bit Adaptor with retaining Ball 12.5 mm (1/2") Drive - internal Hexagon 8 mm (5/16")
292	Bit Adaptor with retaining Ball 10 mm (3/8") Drive - internal Hexagon 8 mm (5/16")
216	Spinner Handle external Square 6.3 mm (1/4") 150 mm
234	„Wobble“ Extension Bar 12.5 mm (1/2") 125 mm
235	„Wobble“ Extension Bar 12.5 mm (1/2") 250 mm
289	Sliding Adaptor for Extension Bars external Square 12.5 mm (1/2")
2232	„Wobble“ Extension Bar 6.3 mm (1/4") 50 mm
2335	Extension Bar 6.3 mm (1/4") 100 mm
246	„Wobble“ Extension Bar 10 mm (3/8") 125 mm
	Internal Hexagon L-Type Key Set, 1.25, 1.5, 2, 2.5, 3, 4, 5 mm
8213	Bit Adaptor with retaining Ball internal Square 6.3 mm (1/4") internal Hexagon 6.3 mm (1/4")
250	Universal Joint 6.3 mm (1/4")
251	Universal Joint 12.5 mm (1/2")
299	Universal Joint 10 mm (3/8")
276	Sliding Handle External Square 6.3 mm (1/4")
318	Reversible Ratchet fine gearing 6.3 mm (1/4")
319	Reversible Ratchet fine gearing 10 mm (3/8")
320	Reversible Ratchet fine gearing 12.5 mm (1/2")

6.3_m 1/4"

Item #	Size
2493	⊖ 4.0 mm
2494	⊖ 5.5 mm
2495	⊖ 6.5 mm
2496	⊖ 7.0 mm
2504	⊕ PH 0
2487	⊕ PH 1
2488	⊕ PH 2
2505	⊕ PZ 0
2490	⊕ PZ 1
2491	⊕ PZ 2
2497	● 3 mm
2498	● 4 mm
2499	● 5 mm
2500	● 6 mm
2589	⊗ T 8
2588	⊗ T 9
2590	⊗ T 10
2591	⊗ T 15
2592	⊗ T 20
2593	⊗ T 25
2594	⊗ T 27
2595	⊗ T 30
2356	⊗ T 8
2364	⊗ T 9
2357	⊗ T 10
2358	⊗ T 15
2359	⊗ T 20
2360	⊗ T 25
2361	⊗ T 27
2362	⊗ T 30

6.3_m 1/4"

Item #	Size
8185	⊕ PH 1
8186	⊕ PH 2
8170	⊕ PZ 1
8172	⊕ PZ 2
	⊗ T 5
	⊗ T 6
	⊗ T 7
8190	⊗ T 10
8191	⊗ T 15
8192	⊗ T 20
8193	⊗ T 25
8194	⊗ T 27
8195	⊗ T 30
8196	⊗ T 40
2436	⊗ T 7
2439	⊗ T 10
2440	⊗ T 15
2441	⊗ T 20
2442	⊗ T 25
2443	⊗ T 27
2444	⊗ T 30
2445	⊗ T 40
	⊗ TS 10
	⊗ TS 15
	⊗ TS 20
	⊗ TS 25
	⊗ TS 27
	⊗ TS 30
	⊗ TS 40
	⊗ TS 45
	● M 5
	● M 6
	● M 7
	● M 8
	● M 9
	● M 5
	● M 6
	● M 8
4456	● 2 mm
4457	● T 70

12.5_m 1/2"

Item #	Size
10630	10 mm
10631	11 mm
10632	12 mm
10633	13 mm
10634	14 mm
10635	15 mm
10636	16 mm
10637	17 mm
10638	18 mm
10639	19 mm
10640	20 mm
10641	21 mm
10642	22 mm
10644	24 mm
10645	27 mm
10646	30 mm
10647	32 mm

10_m 3/8"

Item #	Size
	10 mm
	11 mm
	12 mm
	13 mm
	14 mm
	15 mm
	16 mm
	17 mm
	18 mm
	19 mm

6.3_m 1/4"

Item #	Size
10774	4 mm
10773	4.5 mm
10775	5 mm
10772	5.5 mm
10776	6 mm
10777	7 mm
10778	8 mm
10779	9 mm
10780	10 mm
10781	11 mm
10782	12 mm
10783	13 mm
10784	14 mm

10_m 3/8"

Item #	Size
	10 mm
	11 mm
	12 mm
	13 mm
	14 mm
	15 mm

6.3_m 1/4"

Item #	Size
10702	4 mm
10704	5 mm
10706	6 mm
10707	7 mm
10708	8 mm
10709	9 mm
10710	10 mm

12.5_m 1/2"

Item #	Size
10683	16 mm
10684	17 mm
10685	18 mm
10686	19 mm
10687	22 mm

10_m 3/8"

Item #	Size
6410	E10
6411	E11
6412	E12
6414	E14
6416	E16
6417	E18

6.3_m 1/4"

Item #	Size
6404	E4
6405	E5
6406	E6
6407	E7
6408	E8

12.5_m 1/2"

Item #	Size
6420	E20
6424	E24

12.5_m 1/2"

Item #	Size
2472	16 mm, 12.5 mm (1/2")
2464	18 mm, 10 mm (3/8")
2470	21 mm, 12.5 mm (1/2")

Socket Set Super Lock | 108 pcs.

6.3mm □ 1/4" 12.5mm □ 1/2"



Socket Sets & Tool Assortments

Socket Set Super Lock | 108 pcs.

6.3_m 1/4"

12.5_m 1/2"

Item #
2298





Set Contents

Item #	Description
293	Bit Adaptor with retaining Ball 12.5 mm (1/2") Drive - internal Hexagon 8 mm (5/16")
216	Spinner Handle external Square 6.3 mm (1/4") 150 mm
3120	Extension Bar 12.5 mm (1/2") 125 mm
3121	Extension Bar 12.5 mm (1/2") 250 mm
289	Sliding Adaptor for Extension Bars external Square 12.5 mm (1/2")
2336	Extension Bar 6.3 mm (1/4") 50 mm
2335	Extension Bar 6.3 mm (1/4") 100 mm
276	Sliding Handle external Square 6.3 mm (1/4")
250	Universal Joint 6.3 mm (1/4")
251	Universal Joint 12.5 mm (1/2")
Internal Hexagon L-Type Key Set, 1.5 - 2 - 3 mm 3 pcs.	
318	Reversible Ratchet fine gearing 6.3 mm (1/4")
320	Reversible Ratchet fine gearing 12.5 mm (1/2")

12.5_m 1/2"  



Item #	Size
2410	10 mm
2411	11 mm
2412	12 mm
2413	13 mm
2414	14 mm
2415	15 mm
2416	16 mm
2417	17 mm
2418	18 mm
2419	19 mm
2420	20 mm
2421	21 mm
2422	22 mm
2424	24 mm
2427	27 mm
2430	30 mm
2432	32 mm

6.3_m 1/4"  



Item #	Size
2344	4 mm
2339	4.5 mm
2345	5 mm
2343	5.5 mm
2346	6 mm
2347	7 mm
2348	8 mm
2349	9 mm
2350	10 mm
2351	11 mm
2352	12 mm
2353	13 mm
2354	14 mm

12.5_m 1/2"  

Item #	Size
2472	16 mm, 12.5 mm (1/2")
2470	21 mm, 12.5 mm (1/2")

6.3_m 1/4"  

Item #	Size
2493	⊖ SL4.0
2494	⊖ SL5.5
2495	⊖ SL6.5
2487	⊕ PH1
2488	⊕ PH2
2490	⊕ PZ1
2491	⊕ PZ2
2497	● H3
2498	● H4
2499	● H5
2500	● H6
2589	⊗ T8
2588	⊗ T9
2590	⊗ T10
2591	⊗ T15
2592	⊗ T20
2593	⊗ T25
2594	⊗ T27
2595	⊗ T30

8_m 5/16"  



Item #	Size
4380	⊖ SL8.0
4381	⊖ SL10.0
4382	⊖ SL12.0
4383	⊕ PH3
4384	⊕ PH4
4385	⊕ PZ3
4386	⊕ PZ4
4387	● H7
4388	● H8
4389	● H10
4390	● H12
4391	● H14
8164	⊗ T40
8165	⊗ T45
8166	⊗ T50
8168	⊗ T55
4456	⊗ T60

12.5_m 1/2"  

Item #	Size
2944	14 mm
2945	15 mm
2947	17 mm
2949	19 mm
2952	22 mm

6.3_m 1/4"  

Item #	Size
2966	6 mm
2967	7 mm
2968	8 mm
2969	9 mm
2970	10 mm
2971	11 mm
2972	12 mm
2973	13 mm

12.5_m 1/2"  

Item #	Size
6460	E10
6461	E11
6462	E12
6464	E14
6466	E16
6417	E18
6420	E20
6424	E24

6.3_m 1/4"  

Item #	Size
6404	E4
6405	E5
6406	E6
6407	E7
6408	E8

Socket Set Super Lock | 94 pcs.

6.3mm \square 1/4" 12.5mm \square 1/2"

Socket Sets & Tool Assortments



Socket Set Super Lock | 94 pcs.

6.3_m 1/4"

12.5_m 1/2"

Item #	 
2294	

Set Contents

Item #	Description
293	Bit Adaptor with retaining Ball 12.5 mm (1/2") Drive - internal Hexagon 8 mm (5/16")
216	Spinner Handle external Square 6.3 mm (1/4") 150 mm
234	„Wobble“ Extension Bar 12.5 mm (1/2") 125 mm
3121	Extension Bar 12.5 mm (1/2") 250 mm
289	Sliding Adaptor for Extension Bars external Square 12.5 mm (1/2")
2336	Extension Bar 6.3 mm (1/4") 50 mm
2335	Extension Bar 6.3 mm (1/4") 100 mm
276	Sliding Handle external Square 6.3 mm (1/4")
250	Universal Joint 6.3 mm (1/4")
251	Universal Joint 12.5 mm (1/2")
Internal Hexagon L-Type Key Set 1.5 - 2 - 3 mm 3 pcs.	
318	Reversible Ratchet fine gearing 6.3 mm (1/4")
320	Reversible Ratchet fine gearing 12.5 mm (1/2")

12.5_m 1/2"  

Item #	Size
2410	10 mm
2411	11 mm
2412	12 mm
2413	13 mm
2414	14 mm
2415	15 mm
2416	16 mm
2417	17 mm
2418	18 mm
2419	19 mm
2420	20 mm
2421	21 mm
2422	22 mm
2424	24 mm
2427	27 mm
2430	30 mm
2432	32 mm

12.5_m 1/2"  

Item #	Size
2944	14 mm
2945	15 mm
2947	17 mm
2949	19 mm
2952	22 mm

12.5_m 1/2"  

Item #	Size
2472	16 mm
2470	21 mm

6.3_m 1/4"  

Item #	Size
2344	4 mm
2339	4.5 mm
2345	5 mm
2343	5.5 mm
2346	6 mm
2347	7 mm
2348	8 mm
2349	9 mm
2350	10 mm
2351	11 mm
2352	12 mm
2353	13 mm
2354	14 mm

6.3_m 1/4"  

Item #	Size
2966	6 mm
2967	7 mm
2968	8 mm
2969	9 mm
2970	10 mm
2971	11 mm
2972	12 mm
2973	13 mm

6.3_m 1/4" 

Item #	Size
2493	4.0 mm
2494	5.5 mm
2496	6.5 mm
2487	PH 1
2488	PH 2
2490	PZ 1
2491	PZ 2
2497	3 mm
2498	4 mm
2499	5 mm
2500	6 mm
2589	T 8
2590	T 10
2591	T 15
2592	T 20
2593	T 25
2594	T 27
2595	T 30

8_m 5/16" 

Item #	Size
4380	8.0 mm
4381	10.0 mm
4382	12.0 mm
4383	PH 3
4384	PH 4
4385	PZ 3
4386	PZ 4
4387	7 mm
4388	8 mm
4389	10 mm
4390	12 mm
4391	14 mm
8164	T 40
8165	T 45
8166	T 50
8168	T 55
4456	T 60

Socket Set | 6.3 mm (1/4") / 10 mm (3/8") drive | 92 pcs.

6.3  **1/4** **10**  **3/8**

- 2 ratchets (72 teeth), 6.3 mm (1/4") + 10 mm (3/8")
- sockets, hexagon Pro torque®, 6.3 mm (1/4") drive:
4 - 4,5 - 5 - 6 - 7 - 8 - 9 - 10 - 11 - 13 mm
- sockets, hexagon Pro torque®, deep, 6.3 mm (1/4"):
6 - 8 - 10 - 11 - 13 mm
- 1 bit adaptor 6.3 mm (1/4")
- 1 spinner handle 150 mm for 6.3 mm (1/4")
- 1 universal joint 6.3 mm (1/4")
- 1 extension bar with external square 6.3 mm (1/4")
- 1 sliding bar with adaptor 6.3 mm (1/4")
- sockets, hexagon Pro torque®, 10 mm (3/8") drive:
14 - 15 - 16 - 17 - 19 - 20 - 21 - 22 - 23 - 24 mm
- sockets, hexagon Pro Torque®, deep, 10 mm (3/8") drive:
14 - 16 - 17 - 19 mm
- 1 bit adaptor 10 mm (3/8")
- 1 universal joint 10 mm (3/8")
- 1 extension bar 150 mm, 10 mm (3/8")
- 3 spark plug sockets 16 - 18 - 21 mm
- 29 bits made of chrome-vanadium-steel (S2): slot sl, cross slot PH + PZ, internal hexagon, T-Star (for Torx)
- 9 combination spanners:
6 - 8 - 10 - 11 - 13 - 14 - 16 - 17 - 19 mm
- 9 L-Type keys internal hexagon:
1.5 - 2 - 2.5 - 3 - 4 - 5 - 6 - 8 - 10 mm
- 1 bit adapter 6.3 mm (1/4") drive, 10 mm (3/8")



Item #
2289



Socket Set, Hexagon | 6.3 mm (1/4") / 10 mm (3/8") | Inch sizes | 92 pcs. 6.3 \square 1/4 10 \square 3/8

- Sockets in hexagon Pro torque® design
- 2 fine 72 tooth ratchets external square 6.3 mm (1/4") + 10 mm (3/8")
- sockets, short, 6.3 mm (1/4"): 5/32" - 3/16" - 7/32" - 1/4" - 9/32" - 5/16" - 11/32" - 3/8" - 7/16" - 1/2"
- sockets, deep, 6.3 mm (1/4"): 1/4" - 5/16" - 3/8" - 7/16" - 1/2"
- 1 bit adaptor 6.3 mm (1/4")
- 1 spinning handle, 6.3 mm (1/4")
- 1 universal joint 6.3 mm (1/4")
- 1 extension bar 6.3 mm (1/4")
- 1 sliding bar with adaptor 6.3 mm (1/4")
- sockets, short, 10 mm (3/8"): 9/16" - 19/32" - 5/8" - 11/16" - 3/4" - 25/32" - 13/16" - 7/8" - 15/16" - 1"
- sockets, deep, 10 mm (3/8"): 9/16" - 5/8" - 11/16" - 3/4"
- 1 bit adaptor 10 mm (3/8")
- 1 universal joint 10 mm (3/8")
- 1 extension bar 10 mm (3/8")
- 3 spark plug sockets 5/8" - 3/4" - 13/16"
- 29 pcs. bit set: cross slot PH, cross slot PZ, slot, internal hexagon, T-Star tamperproof (for Torx)
- 9 pcs. combination spanner set: 1/4" - 5/16" - 3/8" - 7/16" - 1/2" - 9/16" - 5/8" - 11/16" - 3/4"
- internal hexagon L-type wrenches: 1/16" - 5/64" - 3/32" - 1/8" - 5/32" - 3/16" - 1/4" - 5/16" - 3/8"
- 1 adaptor 6.3 mm (1/4") to 10 mm 3/8"



Socket Sets & Tool Assortments

Item #	CV CV-S2	1/4" 3/8" 1/2"
2299		

Impact Socket Set Hexagon | 6.3 mm (1/4") + 12.5 mm (1/2") | 69 pcs. 6.3 \square 1/4 12.5 \square 1/2

- for both manual and impact wrenches
- sockets can be fixed on impact wrench by pin and O-ring
- 2 reversible ratchets, 6.3 mm (1/4") + 12.5 mm (1/2"), fine tooth with ergonomic design
- impact sockets, 6.3 mm (1/4") drive: 4 - 4.5 - 5 - 5.5 - 6 - 7 - 8 - 9 - 10 - 11 - 12 - 13 - 14 mm
- impact sockets, 6.3 mm (1/4") drive, deep: 6 - 7 - 8 - 10 - 11 - 12 - 13 mm
- impact sockets, 12.5 mm (1/2") drive: 10 - 11 - 12 - 13 - 14 - 15 - 16 - 17 - 18 - 19 - 20 - 21 - 22 - 24 - 27 - 30 - 32 mm
- 50 mm and 100 mm extension, 6.3 mm (1/4")
- 125 mm and 250 mm extension, 12.5 mm (1/2")
- 12.5 mm (1/2") sliding handle adaptor for extension bar
- sliding handle 6.3 mm (1/4"), 110 mm
- universal joint 6.3 mm (1/4") + 12.5 mm (1/2")
- 150 mm spinning handle, 6.3 mm (1/4")
- bit sockets 6.3 mm (1/4"):
 - slot SL 4 - 5.5 - 7 mm
 - cross slot PH1 - PH2 - PH3
 - cross slot PZ1 - PZ2 - PZ3
 - internal hexagon 3 - 4 - 5 - 6 - 7 - 8 mm
 - T-Star (for Torx) T10 - T15 - T20 - T25 - T30 - T40



Item #	CRO MO CV-S2
5255	

Go-Through Socket Set | Gear Lock | 4.5 - 25 mm | 52 pcs.

- especially suitable for screw connections with long thread overhang, e.g. threaded rods
- no limited depth like "normal" sockets

13 mm hex. drive

- go-through ratchet, 72 teeth, 13 mm inner hex.
- extension bar, 75 mm, with go-through hole
- 11 sockets, Gear Lock, length 25 mm 4.5 - 5 - 5.5 - 6 - 7 - 8 - 9 - 10 - 11 - 12 - 13 mm
- adaptor, 13 mm outer hex. to 6.3 mm 1/4" outer square
- bit adaptor, 13 mm outer hex. to 6.3 mm (1/4") inner hex., allows the ratchet be used as a standard 6.3 mm (1/4") ratchet
- adaptor, 13 mm inner hex. to 6.3 mm (1/4") inner square, to use the extension bar

19 mm hex. drive

- go-through ratchet, 72 teeth, 19 mm inner hex.
- extension bar, 75 mm, with go-through hole
- 11 sockets, Gear Lock, length 30 mm 8 - 10 - 11 - 12 - 13 - 14 - 15 - 16 - 17 - 18 - 19 mm
- adaptor, 19 mm outer hex. to 10 mm (3/8") inner hex., allows the ratchet be used as a standard 10 mm (3/8") ratchet
- adaptor, 19 mm inner hex. to 10 mm (3/8") inner square, to use the extension bar

22 mm hex. drive

- go-through ratchet, 72 teeth, 22 mm inner hex.
- extension bar, 75 mm, with go-through hole
- 7 sockets, Gear Lock, length 19 - 20 - 21 - 22 - 23 - 24 - 25 mm
- adaptor, 22 mm outer hex. to 12.5 mm (1/2") inner hex., allows the ratchet be used as a standard 12.5 mm (1/2") ratchet
- adaptor, 22 mm inner hex. to 12.5 mm (1/2") inner square, to use the extension bar

Bits, drive outer hex. 6.3 mm (1/4"):

- 2 slot: 4 - 5 mm
- 2 cross slot: PH1 - PH2
- 3 T-Star (for Torx): T10 - T15 - T20
- 3 internal hexagon: 4 - 5 - 6 mm



Item #
2181



Socket Set / Tool Assortment | 117 pcs.

6.3mm $\square 1/4"$ 12.5mm $\square 1/2"$

Item #
9029

CV

CV-S2



Tool Assortments

12.5mm $\square 1/2"$

Item #	Size
2910	10 mm
2911	11 mm
2912	12 mm
2913	13 mm
2914	14 mm
2915	15 mm
2917	17 mm
2919	19 mm
2922	22 mm
2924	24 mm
2927	27 mm
2930	30 mm
2932	32 mm



Item #	Size
30556	6 mm
30557	7 mm
30558	8 mm
30559	9 mm
30560	10 mm
30561	11 mm
30562	12 mm
30563	13 mm
30564	14 mm
30567	17 mm
30569	19 mm
30572	22 mm

Set Contents

Item #	Description
216	Spinner Handle external Square 6.3 mm (1/4") 150 Nm
4816	Color Bit Set 32 pcs.
318	Reversible Ratchet fine gearing 6.3 mm (1/4")
320	Reversible Ratchet fine gearing 12.5 mm (1/2") cable shoe assortment
52303	Machinist's Hammer Hickory Handle DIN 1041 300 g
2336	Extension Bar 6.3 mm (1/4") 50 mm
3120	Extension Bar 12.5 mm (1/2") 125 mm
250	Universal Joint 6.3 mm (1/4")
251	Universal Joint 12.5 mm (1/2")
75111	Water Pump Pliers with Box-Joint Type 240 mm
370	Combination Pliers 175 mm
393	Swedish Diagonal Side Cutter 165 mm
418	Cable Lug Crimping Tool 235 mm
9303	Extendable LED Flashlight with Magnetic Pick Up Tool „2-IN-1“
8213	Bit Adaptor with retaining Ball internal Square 6.3 mm (1/4") internal Hexagon 6.3 mm (1/4")

6.3mm $\square 1/4"$

Item #	Size
2474	4 mm
2476	5 mm
2478	6 mm
2479	7 mm
2480	8 mm
2481	9 mm
2482	10 mm
2483	11 mm
2484	12 mm
2485	13 mm

6.3mm $\square 1/4"$

Item #	Size
10509	9 mm
10510	10 mm
10511	11 mm
10512	12 mm
10513	13 mm



Item #	Size
	\ominus 6.0 x 38 mm
	\ominus 6.0 x 100 mm
	\ominus 8.0 x 150 mm
	\oplus PH 1 x 38 mm
4936	\oplus PH 2 x 100 mm

Professional Tool Set in Aluminium Case | 149 pcs.

6.3mm \square 1/4" 12.5mm \square 1/2"

Item #	CV	CV-S2
15501		

Tool Assortments



Professional Tool Set in Aluminium Case | 149 pcs.

6.3_m □ 1/4" 12.5_m □ 1/2"

Set Contents

Item #	Description
217	Spinner Handle for bits external Square 6.3 mm (1/4") 200 mm
4816	Color Bit Set 32 pcs.
318	Reversible Ratchet fine gearing 6.3 mm (1/4")
320	Reversible Ratchet fine gearing 12.5 mm (1/2")
3574	Aluminium Water Level 300 mm
7958	Snap-off Knife Blade width 18 mm
7962	Universal Shears Stainless Steel 180 mm
8394	Measuring Tape 19 mm x 5 m
2064	Plastic Hack Saw 150 mm
15501-2	Cable Lug Assortment 30 pcs.
52303	Machinist's Hammer Hickory Handle DIN 1041 300 g
793	L-Type Key Set extra long T-Star (for Torx) T10 - T50 9 pcs.
808	L-Type Key Set extra long internal Hexagon 1.5 - 10 mm 9 pcs.
2232	„Wobble“ Extension Bar 6.3 mm (1/4") 50 mm
2231	„Wobble“ Extension Bar 6.3 mm (1/4") 100 mm
234	„Wobble“ Extension Bar 12.5 mm (1/2") 125 mm
235	„Wobble“ Extension Bar 12.5 mm (1/2") 250 mm
250	Universal Joint 6.3 mm (1/4")
251	Universal Joint 12.5 mm (1/2")
289	Sliding Adaptor for Extension Bars external Square 12.5 mm (1/2")
276	Sliding Handle external Square 6.3 mm (1/4")
725	Voltage tester 120 - 250 V 140 mm
1441	Adjustable Wrench with soft Rubber Handle max. 26 mm
556	Mechanics Pliers DIN ISO 9242A 250 mm
75111	Water Pump Pliers with Box-Joint 240 mm
369	Combination Pliers 165 mm
388	Telephone Pliers straight 160 mm
393	Swedish Diagonal Side Cutter 165 mm
418	Cable Lug Crimping Tool 235 mm
445	Circlip Pliers for external Circlips 165 mm
446	Circlip Pliers for internal Circlips 165 mm
8213	Bit Adaptor with retaining Ball internal Square 6.3 mm (1/4") internal Hexagon 6.3 mm (1/4")



Tool Assortments

6.3_m □ 1/4"

Item #	Size
2344	4 mm
2339	4.5 mm
2345	5 mm
2343	5.5 mm
2346	6 mm
2347	7 mm
2348	8 mm
2349	9 mm
2350	10 mm
2351	11 mm
2352	12 mm
2353	13 mm
2354	14 mm

12.5_m □ 1/2"

Item #	Size
2410	10 mm
2413	13 mm
2414	14 mm
2416	16 mm
2417	17 mm
2418	18 mm
2419	19 mm
2420	20 mm
2422	22 mm
2424	24 mm
2427	27 mm
2430	30 mm
2432	32 mm



Item #	Size
4902	⊖ 5.0 mm
4904	⊖ 6.0 mm
4908	⊕ PH 1
4910	⊕ PH 2



Item #	Size
30558	8 mm
30560	10 mm
30561	11 mm
30562	12 mm
30563	13 mm
30565	15 mm
30567	17 mm
30569	19 mm

Tool Set in Metal Box | 137 pcs.

6.3_m  12.5_m 

Item #
3306

CV 



Tool Assortments

Set Contents

Item #	Description
447	Circlip Pliers Set 175 mm 4 pcs.
556	Mechanic's Pliers DIN ISO 9242A 250 mm
790	L-Type Key Set extra long internal Hexagon/internal Hexagon with ball point 1.5 - 10 mm 9 pcs.
1442	Adjustable Wrench with soft Rubber Handle max. 31 mm
1640	Panel Chisel 235 mm
1651	Pin Punch Set 150 mm 3 - 8 mm 6 pcs.
1930	Digital Calliper 150 mm
2072	Car Light tester 6 - 24 V
3073	Handheld Brush steel wire 5-rows 300 mm
3083	Precision Feeler Gauges 20 Blades
	Brass Padlock 40 mm
3302	Cantilever Tool Box 530 x 200 x 200 mm 5 pcs.
3855	Machinist's Hammer fibreglass shaft 800 g
4816	Color Bit Set 32 pcs.
7980	Universal Knife break-off segmented Blade 18 mm
8394	Measuring Tape 19 mm x 5 m
2053	Wooden Folding Rule 2 m



Item #	Size
4929	⊖ 4 x 80 mm
4931	⊖ 6.5 x 150 mm
4932	⊕ PZ1 x 75 mm
4933	⊕ PZ2 x 100 mm
4935	⊕ PH1 x 80 mm
4936	⊕ PH2 x 100 mm
4937	⊕ PH3 x 150 mm

Item #	Description
1214	Double Ring Spanner Set offset 6x7 - 30x32 mm 12 pcs.
1196	Combination Spanner Set (DIN 3113A) 6 - 32 mm 25 pcs.
2224	Socket Set 12.5 mm (1/2") Drive 8 - 32 mm 27 pcs.
2936	Socket, Hexagon 12.5 mm (1/2") Drive 36 mm
369	Combination Pliers 165 mm
393	Swedish Diagonal Side Cutter 165 mm

Tool Assortment in Wallet | 270 pcs.

Item #	CV	CV-S2
3322		



Tool Assortments

Set Contents

Item #	Description
370	Combination Pliers 175 mm
75111	Water Pump Pliers with Box-Joint Type 240 mm
52305	Machinist's Hammer Hickory Handle DIN 1041 500 g
790	L-Type Key Set extra long internal Hexagon/internal Hexagon with ball point 1.5 - 10 mm 9 pcs.
2072	Car Light tester 6 - 24 V
14105	Cable Lug Set 160 pcs.
418	Cable Lug Crimping Tool 235 mm
2053	Wooden Folding Rule 2 m
3314	Roll-up Bag for Tools with 15 Compartments 660 x 320 mm empty
1184	Double Open End Spanner Set 6x7 - 30x32 mm 12 pcs.
	Cable Tie Assortment black 100 - 200 mm 75 pcs.



Item #	Size
4929	⊖ 4 x 80 mm
4930	⊖ 5.5 x 125 mm
4931	⊖ 6.5 x 150 mm
	⊖ 8.0 x 200 mm
4935	⊕ PH1 x 80 mm
4936	⊕ PH2 x 100 mm
4937	⊕ PH3 x 150 mm

Metal workshop Tool Case | 3 Drawers | with 143 Tools

6.3mm \square 1/4" 12.5mm \square 1/2"

Item # 3318 CV CV-S2



Tool Assortments

Set Contents

Item #	Description
393	Swedish Diagonal Side Cutter 165 mm
370	Combination Pliers 175 mm
389	Telephone Pliers straight 200 mm
75111	Water Pump Pliers with Box-Joint Type 240 mm
4491	Self Grip Pliers with vinyl grip release Lever 250 mm
4816	Color Bit Set 32 pcs.
3188	Magnetic Lifter 650 mm Capacity 3 kg
318	Reversible Ratchet fine gearing 6.3 mm (1/4")
320	Reversible Ratchet fine gearing 12.5 mm (1/2")
250	Universal Joint 6.3 mm (1/4")
251	Universal Joint 12.5 mm (1/2")
2336	Extension Bar 6.3 mm (1/4") 50 mm
2335	Extension Bar 6.3 mm (1/4") 100 mm
234	„Wobble“ Extension Bar 12.5 mm (1/2") 125 mm
235	„Wobble“ Extension Bar 12.5 mm (1/2") 250 mm
276	Sliding Handle external Square 6.3 mm (1/4")
289	Sliding Adaptor for Extension Bars external Square 12.5 mm (1/2")
216	Spinner Handle external Square 6.3 mm (1/4") 150 Nm
217	Spinner Handle for bits external Square 6.3 mm (1/4") 200 mm

6.3mm \square 1/4"

Item #	Size
2474	4 mm
2475	4.5 mm
2476	5 mm
2477	5.5 mm
2478	6 mm
2479	7 mm
2480	8 mm
2481	9 mm
2482	10 mm
2483	11 mm
2484	12 mm
2485	13 mm
2486	14 mm

12.5mm \square 1/2"

Item #	Size
2908	8 mm
2909	9 mm
2910	10 mm
2911	11 mm
2912	12 mm
2913	13 mm
2914	14 mm
2915	15 mm
2916	16 mm
2917	17 mm
2918	18 mm
2919	19 mm
2920	20 mm
2921	21 mm
2922	22 mm
2923	23 mm
2924	24 mm
2927	27 mm
2930	30 mm
2932	32 mm

6.3mm \square 1/4"

Item #	Size
6404	E4
6405	E5
6406	E6
6407	E7
6408	E8
6430	E10
6431	E11

6.3mm \square 1/4"

Item #	Size
10508	8 mm
10510	10 mm
10511	11 mm
10512	12 mm
10513	13 mm
10514	14 mm



Item #	Size
30556	6 mm
30557	7 mm
30558	8 mm
30559	9 mm
30560	10 mm
30561	11 mm
30562	12 mm
30563	13 mm
30564	14 mm
30567	17 mm
30569	19 mm
30572	22 mm



Item #	Size
30206	6x7 mm
30208	8x9 mm
30210	10x11 mm
30212	12x13 mm
30214	14x15 mm
30216	16x17 mm
30218	18x19 mm
30220	20x21 mm



Item #	Size
4929	\ominus 4 x 80 mm
4930	\ominus 5.5 x 125 mm
4931	\ominus 6.5 x 150 mm
4939	\ominus 8.0 x 200 mm
4935	\oplus PH1 x 80 mm
4936	\oplus PH2 x 100 mm
4937	\oplus PH3 x 150 mm

Foam Tray for Item 3312: Socket Set | 12.5 mm (1/2") + 6.3 mm (1/4") | 77 pcs. **6.3 1/4** **12.5 1/2**

- suitable for toolboxes product no. 3312 & 3318
- 1 reversible ratchet, fine toothed, with socket quick release, offset design, 72 teeth, 6.3 mm (1/4")
- 1 reversible ratchet, fine toothed, with socket quick release, offset design, 72 teeth, 12.5 mm (1/2")
- 1 Spinner handle 150 mm for 6.3 mm (1/4")
- 1 Sliding handle 114 mm for 6.3 mm (1/4")
- 1 sliding bar adaptor for 12.5 mm (1/2") extension bar
- 7 sockets, E-type, 6.3 mm (1/4") drive: E4 - E5 - E6 - E7 - E8 - E10 - E11
- 13 sockets, hexagon Pro torque®, 6.3 mm (1/4") drive: 4 - 4.5 - 5 - 5.5 - 6 - 7 - 8 - 9 - 10 - 11 - 12 - 13 - 14 mm
- 17 sockets, hexagon Pro torque®, 12.5 mm (1/2"): 10 - 11 - 12 - 13 - 14 - 15 - 16 - 17 - 18 - 19 - 20 - 21 - 22 - 24 - 27 - 30 - 32 mm
- 6 sockets, deep, hexagon Pro torque®, 6.3 mm (1/4") drive: 8 - 10 - 11 - 12 - 13 - 14 mm
- 6 bit sockets, T-Star tamperproof (for Torx): T10 - T15 - T20 - T25 - T30 - T40
- 6 bit sockets, internal hexagon drive: 3 - 4 - 5 - 6 - 7 - 8 mm
- 3 bit sockets, cross slot drive PH: PH1 - PH2 - PH3
- 3 bit sockets, plain slot drive: 4 - 5.5 - 6.5 mm
- 1 extension bar 6.3 mm (1/4"), length 50 mm
- 1 extension bar 6.3 mm (1/4"), length 100 mm
- 1 extension bar 12.5 mm (1/2"), length 125 mm
- 1 extension bar 12.5 mm (1/2"), length 250 mm
- 2 universal joints: 6.3 mm (1/4"), 12.5 mm (1/2")
- 2 spark plug sockets, 16 - 21 mm
- surface finish: satin chrome plated
- width: 515 mm
- height: 30 mm
- depth: 215 mm



Item #	Description
3341	Foam Tray for Item 3312: Socket Set 12.5 mm (1/2") + 6.3 mm (1/4") 77 pcs.
3341-1	Foam Tray for Item 3312, empty: for Socket Set

Foam Tray for Item 3312: Double Ring, Combination Spanner Set | 20 pcs.

- cold forged, hardened
- profile ring side: 12-point
- ring head 15° angled
- suitable for toolboxes product no. 3312 & 3318
- 12 combination spanners 6 - 7 - 8 - 9 - 10
11 - 12 - 13 - 14 - 17 - 19 - 22 mm
- 8 double ring spanner, deep offset, 6x7 - 8x9 - 10x11
12x13 - 14x15 - 16x17 - 18x19 - 20x22 mm
- surface finish: satin chrome plated
- width: 500 mm
- height: 30 mm
- depth: 195 mm



Item #	Description
3342	Foam Tray for Item 3312: Double Ring, Combination Spanner Set 20 pcs.
3342-1	Foam Tray for Item 3312, empty: for Combination Spanner Set

Foam Tray for Item 3312: Pliers Set | 5 pcs.

- suitable for toolboxes product no. 3312 & 3318
- diagonal side cutter, 165 mm
2-component handles, blue/black
- long nose pliers, straight, 200 mm
2-component handles, blue/black
- Combination pliers, 175 mm
2-component handles, blue/black
surface finish: chrome plated, matt
- waterpump pliers with box-joint, 240 mm
- max. pliers opening 38 mm, with clamping protection, handle dip insulated
surface finish: forged, lacquered black
- self grip pliers, 250 mm with vinyl release lever,
surface finish: nickel plated
- width: 500 mm
- height: 30 mm
- depth: 195 mm



Item #	Description
3344	Foam Tray for Item 3312: Pliers Set 5 pcs.
3344-1	Foam Tray for Item 3312, empty: for Pliers Set

Foam Tray for Item 3312: Screwdriver, Bit Set and magnetic Lifter | 41 pcs.

- suitable for toolboxes product no. 3312 & 3318
- screwdriver slot: 4 x 80 mm - 5,5 x 125 mm - 6.5 x 150 mm - 8.0 x 200 mm
- screwdriver cross slot PH: PH1 x 80 mm - PH2 x 100 mm - PH3 x 150 mm
- spinner handle for bits, with magnet
 - profile: internal hexagon
 - profile size, metric: 6.3 mm
 - profile size, inch: 1/4"
 - length: 200 mm
- colour bit set
intelligent colour guide, each profile is assigned a colour
- 30 bits, length 25 mm
 - slot sl 3-4-5-6 mm
 - Cross slot PH1 - PH2 - PH2 - PH3
 - Cross slot PZ1 - PZ2 - PZ2 - PZ3
 - internal hexagon 3 - 4 - 5 - 6 mm
 - T-Star (for Torx) T10 - T15 - T20 - T25 - T27 - T30 - T40
 - T-Star tamperproof (for Torx): T10 - T15 - T20 - T25 - T27 - T30 - T40
- 1 bit adapter
- 1 bit-holder with quick release
- magnetic lifter
 - head/magnetic diameter 15 mm
 - the removable protective cover prevents a lateral magnetic effect so that only the desired parts are pulled
 - rubber handle with clip holder
 - length max.: 650 mm
- width: 500 mm
- height: 30 mm
- depth: 195 mm



Item #	Description
3343	Foam Tray for Item 3312: Screwdriver, Bit Set and magnetic Lifter 41 pcs.
3343-1	Foam Tray for Item 3312, empty: for Screwdriver, bit Set and magnetic lifter

Universal Joint Socket, Hexagon | 10 mm (3/8") drive

10 3/8

- chrome plated, polished



Item #	Description
2450	Universal Joint Socket, Hexagon 10 mm (3/8") drive 10 mm
2452	Universal Joint Socket, Hexagon 10 mm (3/8") drive 12 mm
2453	Universal Joint Socket, Hexagon 10 mm (3/8") drive 13 mm
2454	Universal Joint Socket, Hexagon 10 mm (3/8") drive 14 mm
2455	Universal Joint Socket, Hexagon 10 mm (3/8") drive 15 mm
2456	Universal Joint Socket, Hexagon 10 mm (3/8") drive 16 mm
2457	Universal Joint Socket, Hexagon 10 mm (3/8") drive 17 mm
2458	Universal Joint Socket, Hexagon 10 mm (3/8") drive 18 mm
2459	Universal Joint Socket, Hexagon 10 mm (3/8") drive 19 mm



Impact Ball Joint Sockets | 12.5 mm (1/2") drive

12.5 1/2

- suitable for both manual and impact wrenches
- can be fixed on impact wrench by pin and O-ring
- profile: hexagon
- length: 65 mm



Item #	Description
5200-16	Impact Ball Joint Socket 12.5 mm (1/2") drive 16 mm
5200-17	Impact Ball Joint Socket 12.5 mm (1/2") drive 17 mm
5200-18	Impact Ball Joint Socket 12.5 mm (1/2") drive 18 mm
5200-19	Impact Ball Joint Socket 12.5 mm (1/2") drive 19 mm



Impact Protective Sockets | 12,5 mm (1/2") drive

12.5 1/2

- suitable for both manual and impact wrenches
- with plastic cover for perfect protection of aluminium rims
- with ball retaining groove and hole
- with colour coding for quick identification
- length 85 mm



Item #	Description
7207	Protective Impact Socket 12.5 mm (1/2") drive 15 mm
7209	Protective Plastic Cover for BGS 7207 Ø 15 mm
7201	Protective Impact Socket 12.5 mm (1/2") drive 17 mm
7204	Protective Plastic Cover for BGS 7201 Ø 17 mm
7202	Protective Impact Socket 12.5 mm (1/2") drive 19 mm
7205	Protective Plastic Cover for BGS 7202 Ø 19 mm
7203	Protective Impact Socket 12.5 mm (1/2") drive 21 mm
7206	Protective Plastic Cover for BGS 7203 Ø 21 mm
7208	Protective Impact Socket 12.5 mm (1/2") drive 22 mm
7198	Protective Plastic Cover for BGS 7208 Ø 22 mm



Protective Impact Sockets | 12.5 mm (1/2") drive

12.5  1/2

- for both manual and impact wrenches
- can be fixed on impact wrench by pin and O-ring
- with plastic cover for perfect protection of aluminium rims
- colour-coded plastic sleeve



Item #	Description
7301	Protective Impact Socket 12.5 mm (1/2") drive 17 mm
7304	Protective Plastic Cover for BGS 7301 Ø 17 mm blue
7302	Protective Impact Socket 12.5 mm (1/2") drive 19 mm
7305	Protective Plastic Cover for BGS 7302 Ø 19 mm yellow
7303	Protective Impact Socket 12.5 mm (1/2") drive 21 mm
7306	Protective Plastic Cover for BGS 7303 Ø 21 mm red

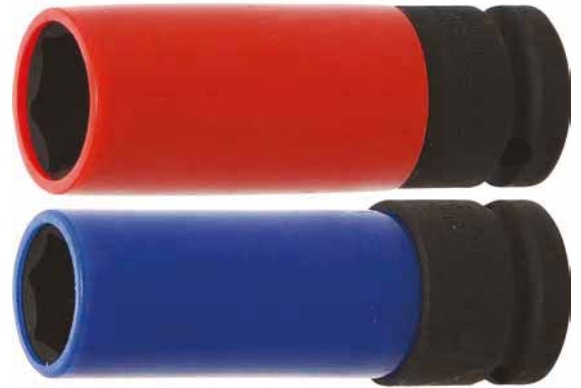

Sockets 12.5 mm (1/2")

Special Wheel Nut Socket | for Mercedes Benz S series | 12.5 mm (1/2")

12.5  1/2

- suitable for both manual and impact wrenches
- can be fixed on impact wrench by pin and O-ring
- special profile for Mercedes Benz
- wrench size: MS 17 mm

Item #	 
2255	



Special Wheel Nut Socket | for Mercedes Benz S series | 12.5 mm (1/2")

12.5  1/2

- suitable for both manual and impact wrenches
- can be fixed on impact wrench by pin and O-ring
- with plastic cover for perfect protection of aluminium rims
- special profile for Mercedes Benz
- wrench size: MS 17 mm
- length: 85 mm

Item #	 
7309	

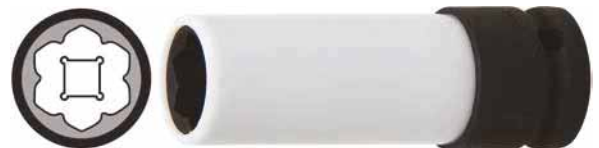

Protective Sleeve Impact Socket | for Hyundai i30, Tucson & Kia | 12.5 mm (1/2") drive | 21 mm

12.5  1/2

- suitable for both manual and impact wrenches
- can be fixed on impact wrench by pin and O-ring
- with plastic cover for perfect protection of aluminium rims
- colour-coded plastic sleeve
- special profile for Hyundai i30, Tucson & Kia
- wrench size: 21 mm
- length: 85 mm

Item #	
9371	



Protective Impact Sockets | 12.5 mm (1/2") drive

12.5 \square 1/2

- for both manual and impact wrenches
- can be fixed on impact wrench by pin and O-ring
- with plastic cover for perfect protection of aluminium rims
- colour-coded nut
- extra long for deep centre rims



Item #	Description
7101	Protective Impact Socket 12.5 mm (1/2") drive 17 mm
7102	Protective Impact Socket 12.5 mm (1/2") drive 19 mm
7103	Protective Impact Socket 12.5 mm (1/2") drive 21 mm

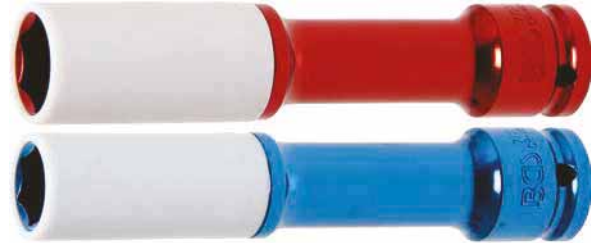

Special Socket Set / Screw Extractors | 10 mm (3/8") drive | 10 - 19 mm | 10 pcs. 10 \square 3/8

- for loosening damaged screws and nuts
- suitable for impact wrenches
- the innovative spiral profile digs itself into the head of a damaged screw/ nut and thereby allows to loosen it securely
- special twist socket, 10 mm (3/8") drive: 10 - 11 - 12 - 13 - 14 - 15 - 16 - 17 - 19 mm
- surface finish: black burnished

Item #
5265



Special Socket Set / Screw Extractors | 12.5 mm (1/2") drive | 10 - 19 mm | 10 pcs. 12.5 \square 1/2

- for loosening damaged screws and nuts
- suitable for impact wrenches
- the innovative spiral profile digs itself into the head of a damaged screw/ nut and thereby allows to loosen it securely
- special twist socket, 12.5 mm (1/2") drive: 10 - 11 - 12 - 13 - 14 - 15 - 16 - 17 - 19 mm
- surface finish: black burnished

Item #
5266



Special Socket Set / Screw Extractors | 12.5 mm (1/2") drive | 8 - 27 mm | 16 pcs. **12.5** \square $\frac{1}{2}$

- for loosening damaged screws and nuts
- suitable for impact wrenches
- the innovative spiral profile digs itself into the head of a damaged screw/ nut and thereby allows to loosen it securely
- special twist socket, 12.5 mm (1/2") drive: 8 - 10 - 11 - 12 - 13 - 14 - 15 - 16 - 17 - 19 - 21 - 22 - 24 - 27
- surface finish: black burnished



Item #
5269



Special Socket Set / Screw Extractors | 12.5 mm (1/2") + 20 mm (3/4") drive | 22 - 41 mm | 6 pcs.

- for loosening damaged screws and nuts
- suitable for impact wrenches
- the innovative spiral profile digs itself into the head of a damaged screw/ nut and thereby allows to loosen it securely
- special twist socket, 12.5 mm (1/2") drive: 22 - 24 - 27 - 32 mm
- special twist socket, 20 mm (3/4") drive: 36 - 41 mm
- single sizes available



Item #
5268



Special Socket Set / Screw Extractors, deep | 12.5 mm (1/2") drive | 17 - 21 mm | 4 pcs. **12.5** \square $\frac{1}{2}$

- 150 mm long
- for loosening damaged screws and nuts, also suitable for impact wrenches
- the innovative spiral profile digs itself into the head of a damaged screw / nut and thereby allows to loosen it securely
- special sockets, length: 150 mm, 17 - 19 - 21 mm
- incl. tommy bar
- surface finish: black burnished



Item #
5264



Special Socket Set / Screw Extractors, deep | 12.5 mm (1/2") drive | 17 - 22 mm | 5 pcs. 12.5 \square 1/2

- for loosening damaged screws and nuts
- suitable for impact wrenches
- the innovative spiral profile digs itself into the head of a damaged screw/ nut and thereby allows to loosen it securely
- special twist socket, length: 150 mm, 12.5 mm (1/2") drive: 17 - 19 - 21 - 22 mm
- incl. tommy bar
- surface finish: black burnished



Item #	CRO MO
5262	

Pin Punch for Twist Sockets

- for use with sockets from BGS 5262 / 5264
- stuck socket heads can easily be driven out of the socket

Item #	CRO MO
5264-TB	



Special Socket Set / Screw Extractors | 12.5 mm (1/2") drive | 17 - 26 mm | 4 pcs. 12.5 \square 1/2

- ideal for loosening of heavily damaged screws and nuts
- especially for wheel nuts, locking nuts, etc.
- dimensions 17 - 18.5 - 21.5 - 26 mm
- in metal case



Item #	CRO MO
5260	

Screw and Stud Extractor Set | 17 pcs. 10 \square 3/8

- solves problems with rounded or torn off sockets and bolts
- 5 screw extractors with left side thread for loosening damaged internal hex screws
- 4 stud sockets 6 - 8 - 10 - 12 mm with clamping device, e.g. for studs
- 8 special sockets for loosening rounded off hexagon nuts 9 - 10 - 11 - 12 - 13 - 14 - 16 - 19 mm (also used to tighten screws)



Item #	CRO MO
8378	

Special Socket Set | Screw Extractors | 2 - 10 mm | 6 pcs.

10  3/8

- 2-3-4-6-8-10 mm
- for loosening damaged inner nuts (e.g. internal hexagon, T-star etc.)
- the innovative spiral profile digs itself into the head and enables a safe release of the otherwise no longer actuated drive profile



Item #	Description
5281	Special Socket Set / Screw Extractors 10 mm (3/8") drive 2 - 10 mm 6 pcs.
5281-2	Special Socket / Screw Extractor 10 mm (3/8") drive 2 mm
5281-3	Special Socket / Screw Extractor 10 mm (3/8") drive 3 mm
5281-4	Special Socket / Screw Extractor 10 mm (3/8") drive 4 mm
5281-6	Special Socket / Screw Extractor 10 mm (3/8") drive 6 mm
5281-8	Special Socket / Screw Extractor 10 mm (3/8") drive 8 mm
5281-10	Special Socket / Screw Extractor 10 mm (3/8") drive 10 mm



Special Sockets

Special Socket Set / Screw Extractors | 8 - 16 mm | 5 pcs.

12.5  1/2

- for loosening damaged inner nuts (e.g. internal hexagon, T-star etc.)
- suitable for impact wrenches
- the innovative spiral profile digs itself into the head and enables a safe release of the otherwise no longer actuated drive profile
- special twist socket Twist, 12.5 mm (1/2") drive, twist: 8 - 10 - 12 - 14 - 16 mm
- surface finish: black burnished



Item #
5261



Screw Extractor Set | 5 pcs.

- carbon steel
- for all types of cross, T-Star and internal hexagon screws
- 5 different sizes
- for use with an electric drill (max. 250 rpm)



Item #
5282



Screwdriver Set | for damaged T-Star (for Torx) T10 - T40 | 7 pcs.

- allows dismantling of screws with damaged T-star (for Torx) screw heads
- 7 extractor bits, for T-Star (for Torx) screw heads T10 - T15 - T20 - T25 - T27 - T30 - T40, 6.3 mm (1/4") drive hexagon drill shaft
- length: 50 mm



Item #
5284



Screw Extractor Set | for damaged internal Hexagon 1.5 - 6 mm | 7 pcs.

- allows for dismantling of screws with damaged inner hex. screw heads
- 7 extractor bits, for inner hex. screw heads 1.5 - 2 - 2.5 - 3 - 4 - 5 - 6 mm, 6.3 mm (1/4") drive hexagon drill shaft
- length: 50 mm



Item #
5289



HSS Screw Extractor Set | 25 pcs.

- for professional turning out of broken screws and studs
- reduces time and cost
- HSS-steel
- 5 HSS drills 3.2 - 4.8 - 6.4 - 8.0 - 8.7 mm
- 10 guide bushings for drills
- 5 extractor pins
- 5 extractor adaptors



Item #
8462

Screw Extractor Set | 10 pcs.

- allows removal of screws with damaged head
- suitable for internal hexagon, T-Star (for Torx), spline screws (for XZN) etc.
- extractor bits with hexagon drive in following sizes 3 - 4 - 5.5 - 6 - 7 - 8 - 9 - 10 - 11 mm
- also suitable for screws with inch drive 1/8" - 5/32" - 3/16" - 7/32" - 1/4" - 9/32" - 5/16" - 11/32" - 3/8" - 13/32"
- 13 mm hexagon drive



Item #
8547

Screw Extractor Set | 25 pcs.

- allows removal of screws with damaged head
- suitable for internal hexagon, T-Star (for Torx), spline screws (for XZN) etc.
- extractors with hexagon drive in following sizes: 3 - 4 - 5 - 5.5 - 6 - 7 - 8 - 9 - 10 - 11 - 12 - 13 - 13.5 - 14 - 15 - 16 - 17 - 17.5 - 18 - 19 - 20 - 21 - 21.5 - 22 mm
- also suitable for screws in inch sizes: 1/8" - 5/32" - 3/16" - 7/32" - 1/4" - 9/32" - 5/16" - 11/32" - 3/8" - 11/32" - 7/16" - 15/32" - 1/2" - 17/32" - 9/16" - 19/32" - 5/8" - 21/32" - 11/16" - 23/32" - 3/4" - 25/32" - 13/16" - 27/32" - 7/8"



Item #
8548

Damaged Screw Extractor / Bit Set | 13 pcs.

- 6 left threaded screw extractors
 - 3 conical from 3 - 14 mm
 - 3 cylindric 2 - 3.2 - 4.2 mm
- 6 bits
 - cross slot PH 1 / PH2
 - cross slot PZ1 / PZ2
 - slot 4 / 5 mm
- 1 quick release bit holder



Item #
5280



Screw Extractor Set | for damaged T-Star (for Torx) T10 - T55 | 11 pcs.

- allows dismantling of screws with damaged T-star (for Torx) screw heads
- 7 extractor bits with 6.3 mm (1/4") hexagon drill shaft for T-Star (for Torx) screw heads T10 - T15 - T20 - T25 - T27 - T30 - T40, length: 50 mm
- 3 extractor bits with 10 mm (3/8") hexagon drive for T-Star (for Torx) screw heads T45 - T50 - T55, length: 38 mm
- 12.5 mm (1/2") bit adaptor for 10 mm (3/8") extractor bits



Item #
9170



Screw Extractor Set | 6 pcs.

- for unscrewing broken screws
- in sizes: 1, 2, 3, 4, 5 and 6
- square drive for tool holders



Item #
8549



Screw Extractor Set | sizes 1 - 5 | 5 pcs.

- for dismantling torn screws and stud bolts
- carbon steel
- in a plastic case

suitable for following screws:

- 3 - 6 mm (1/8" - 1/4")
- 6 - 8 mm (1/4" - 5/16")
- 8 - 11 mm (5/16" - 7/16")
- 11 - 14 mm (7/16" - 9/16")
- 14 - 19 mm (9/16" - 3/4")



Item #	
1895	

Screw Extractor Set | sizes 1 - 6 | 6 pcs.

- for dismantling torn screws and stud bolts
- carbon steel
- in a plastic case

suitable for following screws:

- 3 - 6 mm (1/8" - 1/4")
- 6 - 8 mm (1/4" - 5/16")
- 8 - 11 mm (5/16" - 7/16")
- 11 - 14 mm (7/16" - 9/16")
- 14 - 19 mm (9/16" - 3/4")
- 19 - 25 mm (3/4" - 1")



Item #	
1896	

Special Sockets | for BMW rim locks | 3 pcs.

12.5  1/2

- Special socket for BMW rim locks 17T x 14.5 mm
- Special socket for BMW rim locks 10T x 16.0 mm
- Special socket for BMW rim locks 21T x 16.5 mm



Item #	
5285	

Rim Lock Socket Set for BMW | 21 pcs.

12.5  1/2

- for dismantling BMW rim locks
- Rim lock dismantling sockets with 17 mm hexagon drive
- in workshop trolley tray
- includes rim lock dismantling sockets in following sizes: 30/13-pt. - 31/15-pt. - 32/16-pt. - 12/14-pt. 11/15-pt. - 33/17-pt. - 34/16-pt. - 35/19-pt. - 16/10-pt. - 15/11-pt. - 14/12-pt. - 36/20-pt. 37/21-pt. - 38/22-pt. - 40/23-pt. - 18/13-pt. - 17/7-pt. - 20/9-pt. - 19/8-pt.
- Protective Impact Socket, 12.5 mm (1/2"), 17 mm

Item #		1 6
8932		

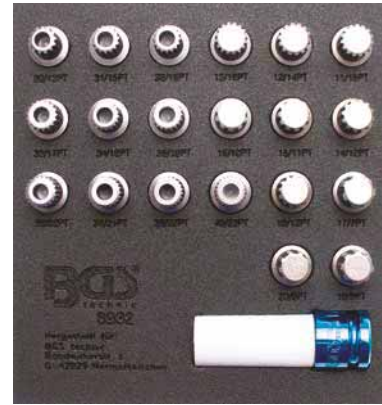

Rim Lock Socket Set for BMW | 20 pcs.

- for dismantling BMW rim locks
- includes 20 rim lock sockets in following sizes: #41 - #42 - #43 - #44 - #45 - #46 - #47 - #48 - #49 - #50 - #51 - #52 - #53 - #54 - #55 - #56 - #57 - #58 - #59 - #60
- 17 mm hexagon drive

Item #		1 6
8962		

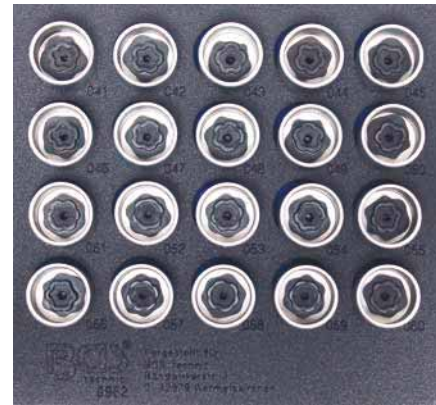

Rim Lock Socket Set for VAG | 23 pcs.

12.5  1/2

- for dismantling VAG rim locks
- rim lock dismantling sockets with 17 mm hexagon drive
- in workshop trolley tray
- rim lock dismantling sockets in following sizes: 51/6-pt. - 52/7-pt. - 53/8-pt. - 55/10-pt. -56/11-pt. - 57/12-pt. - 58/13-pt. -60/15-pt. - 61/16-pt. - 62/17-pt. - ABC0/10-pt. - ABC1/11-pt. - ABC2/13-pt. -ABC3/14-pt. - ABC4/15-pt. - ABC5/16-pt. -ABC6/17-pt. - ABC7/19-pt. - ABC8/20-pt. - ABC9/21-pt.
- Protective Impact Socket, 12.5 mm (1/2"), 17 mm

Item #		1 6
8933		



Rim Lock Socket Set for VAG | 20 pcs.

- for dismantling rim locks
- includes 20 rim lock sockets in following sizes: #521 - #522 - #523 - #524 - #525- #526 - #527 - #528 - #529 - #530- #531 - #532 - #533 - #534 - #535- #536 - #537 - #538 - #539 - #540
- 17 mm hexagon drive

Item #		1 6
8963		



Special Sockets

Rim Lock Tool Set for Porsche and VW Touareg | 20 pcs.

- for dismantling rim locks
- 20 rim lock sets in following sizes: #50x14-pt. - #51x15-pt. - #52x16-pt. - #53x17-pt. - #53x18-pt. - #55x19-pt. - #56x20-pt. - #57x21-pt. - #58x22-pt. - #59x23-pt. - #60x14-pt. - #61x15-pt. - #62x16-pt. - #63x17-pt. - #64x18-pt. - #65x19-pt. - #66x20-pt. - #67x21-pt. - #68x22-pt. - #69x23-pt.
- drive: 19 mm hexagon



Item #		1 / 6
9099		

Rim Lock Socket Set for Audi | 20 pcs.

- for dismantling rim locks
- 20 rim lock sockets in sizes: #801 - #802 - #803 - #804 - #805 - #806 - #807 - #808 - #809 - #810 - #811 - #812 - #813 - #814 - #815 - #816 - #817 - #818 - #819 - #820
- 17 mm external hexagon drive
- to be used as OEM tool T40073



Item #		1 / 6
9499		

Rim Lock Socket Set for Mercedes | 12 pcs.

- for installation and dismantling of Mercedes-Benz rim locks
- including rim lock sockets for following Mercedes-Benz models: A-Class, B-Class, C-Class, GLK-Class, CLC-Class, CLS-Class, CLK-Class, E-Class, SL-Class, SLK-Class, M-Class, R-Class
- in workshop trolley tray
- 10 pcs. rim lock sockets
- 1 socket to be used as holder
- 1 punch pin

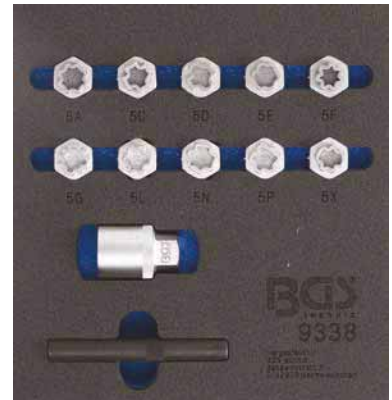

Item #		1 / 6
9338		

10-piece Rim Lock Dismantling Tool Set

- allows professional disassembly of rim locks
- "open" almost all rim locks without damaging the rim
- conical dismantling sockets allow high power transmission
- material: S45C and SCM440
- 8 conical dismantling sockets, length 60 mm, with the following inner diameters
 - Ø 18.3 x Ø 16.4 mm
 - Ø 19.5 x Ø 17.6 mm
 - Ø 20.4 x Ø 18.5 mm
 - Ø 21.6 x Ø 19.7 mm
 - Ø 22.5 x Ø 20.6 mm
 - Ø 23.6 x Ø 21.7 mm
 - Ø 24.5 x Ø 22.6 mm
 - Ø 25,5 x Ø 23,6 mm
- 2 dismantling mandrels



Item #	Description
8656	10-piece Rim Lock Dismantling Tool Set
8656-3	Rim Lock Dismantling Socket Ø 18.3 x 16.4 mm
8656-4	Rim Lock Dismantling Socket Ø 19.5 x 17.6 mm
8656-5	Rim Lock Dismantling Socket Ø 20.4 x 18.5 mm
8656-6	Rim Lock Dismantling Socket Ø 21.6 x 19.7 mm
8656-7	Rim Lock Dismantling Socket Ø 22.5 x 20.6 mm
8656-8	Rim Lock Dismantling Socket Ø 23.6 x 21.7 mm
8656-9	Rim Lock Dismantling Socket Ø 24.5 x 22.6 mm
8656-10	Rim Lock Dismantling Socket Ø 25.5 x 23.6 mm



Special Sockets

Groove Nut Socket Set | 5 pcs.

12.5 □ 1/2

- suitable for Mercedes differential, gear and rear axle flange
- for Mercedes of the 107, 114, 115, 116, 126 series etc.
- allows gentle loosening and tightening using a torque wrench

Item #
67220



Groove Nut Socket Set | outside taps | KM0-1-2-3-8-9 | 11 pcs.

12.5  1/2

- for easy loosening and tightening of grooved nuts according to DIN 981 on shafts, clamping or pulling sleeves etc.
- taps positioned outside
- suitable for e.g. bearing nuts
- 12.5 mm (1/2") drive
- length 60 mm

External Ø (D1) x internal Ø (D2) x tooth width (TW)

- 22,0 mm x 15,5 mm x 2,6 mm (KM 0)
- 26,0 mm x 18,5 mm x 2,6 mm (KM 1)
- 30,0 mm x 21,5 mm x 3,5 mm (KM 2)
- 33,0 mm x 25,0 mm x 3,8 mm (KM 3)
- 37,0 mm x 27,5 mm x 4,0 mm
- 44,0 mm x 33,5 mm x 4,5 mm
- 50,0 mm x 38,5 mm x 4,7 mm
- 56,0 mm x 44,5 mm x 4,7 mm
- 63,0 mm x 50,5 mm x 5,7 mm
- 69,0 mm x 55,5 mm x 5,5 mm (KM 8)
- 75,0 mm x 61,5 mm x 5,5 mm (KM 9)



Item #	Description
8265	Groove Nut Socket Set outside taps KM0-1-2-3-8-9 11 pcs.
8265-1	Groove Nut Socket with external tooth 22 mm KM0
8265-2	Groove Nut Socket with external tooth 26 mm KM1
8265-3	Groove Nut Socket with external tooth 30 mm KM2
8265-4	Groove Nut Socket with external tooth 33 mm KM3
8265-5	Groove Nut Socket with external tooth 37 mm
8265-6	Groove Nut Socket with external tooth 44 mm
8265-7	Groove Nut Socket with external tooth 50 mm
8265-8	Groove Nut Socket with external tooth 56 mm
8265-9	Groove Nut Socket with external tooth 63 mm
8265-10	Groove Nut Socket with external tooth 69 mm KM8
8265-11	Groove Nut Socket with external tooth 75 mm KM9

Groove Nut Socket Set | inside taps | KM0 - KM12 | 13 pcs.

12.5  1/2

- for easy loosening and tightening of grooved nuts according to Din standard 981 on shafts, clamping or pulling sleeves etc.
- suitable for following grooved nut sizes:
KM0 (M10) - KM1 (M12) - KM2 (M15) - KM3 (M17) - KM4 (M20) -
KM5 (M25) - KM6 (M30) - KM7 (M35) - KM8 (M40) - KM9 (M45) -
KM10 (M50) - KM11 (M55) - KM12 (M60)
- length: 60 mm



Item #
9385



Groove Nut Socket with Internal Tooth

12.5  1/2

- for gentle loosening the grooved nuts
- suitable for e.g. bearing nuts
- 12,5 (1/2) drive, length 60 mm
- for grooved nuts according to DIN 981 sizes KM0 - KM1 - KM2 - KM3 - KM4 - KM5 - KM6 - KM7 - KM8 - KM9
- Inner Ø (D1) x tooth distance (TD) x tooth width (TW):
 - 20.0 mm x 15.3 mm x 2.6 mm
 - 23.5 mm x 18.5 mm x 2.6 mm
 - 26.5 mm x 21.5 mm x 2.6 mm
 - 29.5 mm x 24.5 mm x 3.3 mm
 - 34.5 mm x 27.3 mm x 3.4 mm
 - 40.5 mm x 33.2 mm x 4.3 mm
 - 46.5 mm x 38.3 mm x 4.3 mm
 - 59.5 mm x 50.4 mm x 5.3 mm
 - 65.8 mm x 55.4 mm x 5.4 mm
 - 71.8 mm x 61.4 mm x 5.4 mm



Item #	Description
8266-1	Groove Nut Socket with internal tooth 20.0 mm KM0
8266-2	Groove Nut Socket with internal tooth 23.5 mm KM1
8266-3	Groove Nut Socket with internal tooth 26.5 mm KM2
8266-4	Groove Nut Socket with internal tooth 29.5 mm KM3
8266-5	Groove Nut Socket with internal tooth 34.5 mm
8266-6	Groove Nut Socket with internal tooth 40.5 mm
8266-7	Groove Nut Socket with internal tooth 46.5 mm KM6
8266-8	Groove Nut Socket with internal tooth 59.5 mm KM7
8266-9	Groove Nut Socket with internal tooth 65.8 mm
8266-10	Groove Nut Socket with internal tooth 71.8 mm KM8



Special Sockets

Special Sockets for elbow connectors | 5 pcs.

10  3/8

- for tightening and loosening elbow connectors (L-type pipe connectors)
- suitable for e.g. following angle connections on:
 - car and trucks air suspension
 - compressed air braking systems
 - machinery
- facilitates work in narrow spaces
- contains 5 open sockets, 12 - 14 - 17 - 19 - 22 mm

Item #		
9089		

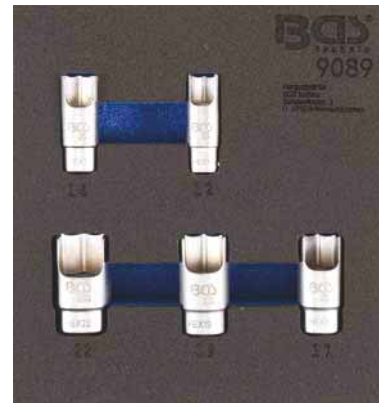

Special Socket Set, slotted | 10 mm (3/8") drive | 10 - 19 mm | 7 pcs.

10  3/8

- for the assembly of top and side wired temperature sensors, thermo switches and other components
- also suitable for nuts and bolts on bent pipes
- the slot width is: 7.4 mm - 8.8 mm - 9.1 mm - 9.7 mm - 10.5 mm - 13.3 mm - 14.4 mm
- incl. socket rail
- Slotted special socket set, drive internal square 10 mm (3/8"):
10 - 11 - 12 - 13- 14 - 17 - 19 mm
- surface finish: satin chrome-plated



Item #	 
1105	

Special Socket Set | 12.5 mm (1/2") drive | 12 - 19 mm

12.5  1/2

- especially suitable for pipeline fittings
- no widening because foot has special profile
- angled, slotted socket with 12-point
- special sockets, length: 98 mm, 12.5 mm (1/2") drive: 12 - 14 - 16 - 17 - 18 - 19 mm





Item #
1300

Multi Socket | 12.5 mm (1/2") drive | 11 - 32 mm

12.5  1/2

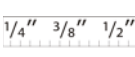
- suitable for all hexagon bolts and nuts
- in inches and metric sizes
- not suitable for use on rim / wheel locks

Item #	  
2531	



Multi Socket | 10 mm (3/8") drive | 9 - 21 mm

10  3/8

- suitable for all hexagon bolts and nuts
- in inches and metric sizes
- not suitable for use on rim / wheel locks

Item #	  
2533	



Special Car Sockets | 3- / 5- / 6- / 10-point | 10 pcs.

12.5 1/2

- 10S, hexagon, for Toyota
- 6S, hexagon, for Nissan and Renault clutch
- 8S, 6pt., for Nissan cylinder head & balance shaft
- 12S, 6pt., for Nissan cylinder head
- 8TS, 3pt., for Nissan balance shaft
- 10 mm, 5pt., for brake systems
- 12 mm, 5pt., for Nissan fuel pump
- 14 mm, 5pt., for GM & Smart Car
- 19 mm, 5pt., for Peugeot, Renault & Citroen parking brake
- 20 mm, 10pt., for Honda Civic lower control arm
- length 38 mm



Item #	
2560	

Socket Set | spline profile (for RIBE) M6S, M8S, M12S | 3 pcs.

12.5 1/2

- knurled
- sockets, Spline (for RIBE),
12.5 mm (1/2") drive: M6S, M8S, M12S
- surface finish: black phosphated
- special sizes suitable for:
Nissan, Renault, for couplings, cylinder heads etc.



Item #	
9336	

3-pt Socket Set | M5 - M12 (8 - 16,5 mm) | 5 pcs.

12.5 1/2

- sizes: M5 - M6 - M8 - M10 - M12
- knurled
- 12.5 mm (1/2") drive
- suitable for VAG TDI injector pump adjuster, Bosch injectors, control cabinets and barriers
- surface finish: satin chrome plated



CV	

Item #	Description
8608	3-pt Socket Set M5 - M12 (8 - 16,5 mm) 5 pcs.
7460	3-pt Socket M5 (8 mm)
7461	3-pt Socket M6 (10 mm)
7462	3-pt Socket M8 (12 mm)
7463	3-pt Socket M10 (15 mm)
7464	3-pt Socket M12 (16.5 mm)

Oxygen Sensor Impact Loosening Wrench

- for loosening of oxygen sensors
- suitable for e.g. air hammer BGS 3515
- 10 mm shank diameter
- suitable for oxygen sensors with hexagonal profile, 22 mm



Item #
8791

Oxygen Sensor Socket Set | 7 pcs.

10 \square 3/8 12.5 \square 1/2

- for assembly of oxygen sensors, radiator thermo switch and Diesel injection nozzles

sizes contained:

- 29 x 90 mm, 12,5 mm (1/2") drive, slot 7 mm
- 22 x 90 mm, 10 mm (3/8") drive, slot 20 mm
- 22 x 74 mm, 10 mm (3/8") drive
- 27 x 78 mm 12-point, 12,5 mm (1/2") drive, window 28 mm
- 22 x 80 mm, 10 mm (3/8") drive, slot 9 mm
- 22 mm offset, 10 mm (3/8") drive, slot 8 mm
- 22 mm offset, 12,5 mm (1/2") 8-point drive, slot 11 mm



Item #	Description
1140	Oxygen Sensor Socket Set 7 pcs.
1140-22	Oxygen Sensor Socket angled 12.5 mm (1/2") 8-point drive 22 mm 11 mm slot
1148	Oxygen Sensor Socket 10 mm (3/8") drive 22 mm x 90 mm 20 mm slot
1140-27	Oxygen Sensor Socket 12.5 mm (1/2") drive 27 mm 12-point, 28 mm window

Socket Set, E-Type, extra long | 12.5 mm (1/2") drive | E10 - E20 | 6 pcs.

12.5 \square 1/2

- length 140 mm
- E10 - E12 - E14 - E16 - E18 - E20
- with locking ball
- E12 x 150 mm for BMW cylinder head also available separately under BGS 2020



Item #
2028



Socket for BMW Cylinder Head E-Type, 150 mm | 12.5 mm (1/2") drive | E12 12.5 1/2

- with locking ball

suitable for:

- engine M42, 1.8 l, 4-cylinder, 16V, model 318 as of 1989
- engine M50, 2.0 l, 2.5 l, 6 cylinder, 24V, model 520i, 525i as of 1991
- length: 150 mm



Item #
2020

Claw Socket for Mercedes Ignition Lock Rosette

- for dismantling of ignition locks
- to be used as OEM 210589000700
- suitable for Mercedes-Benz: W129, W140, W202, W210, W220, W203, W209, W211, W204



Item #
62675



Socket, E-Type, extra long | 22 mm drive

- for use with air tools
- profile: E-type
- length: 100 mm
- surface finish: black burnished



Item #	Description
5246-E18	Socket, E-Type, extra long 22 mm drive E18
5246-E20	Socket, E-Type, extra long 22 mm drive E20
5246-E22	Socket, E-Type, extra long 22 mm drive E22
5246-E24	Socket, E-Type, extra long 22 mm drive E24



Flexible Hexagon Screwdriver

- for mounting 6-pt type
- mainly for operating hose clamps
- anti-slip, ergonomically formed 2-component handle

Item #	Description
7826	Flexible Hexagon Screwdriver 6 mm
7827	Flexible Hexagon Screwdriver 7 mm
7828	Flexible Hexagon Screwdriver 8 mm



Hose Clamp Screwdriver | external square 6.3 mm (1/4") | 500 mm

- incl. 3 socket hexagon, drive 6.3 mm (1/4") drive
- 4 - 5 - 7 mm
- anti-slip 2-component handle
- for hose clamps



Item #
7824



Socket Set with T-Handle | 6 - 14 mm | 9 pcs.

- external hexagon for holding a combination spanner, for particularly hard to loose screw connections
- 6 - 7 - 8 - 9 - 10 - 11 - 12 - 13 - 14 mm
- profile: chrome-plated
- length: 230 mm



Item #
7801



Socket with T-Handle, Hexagon

- extra heavy plastic handles with hanging holes
- External hexagon for hard to loose screw connections



Item #	Description
7806	Socket with T-Handle, Hexagon 6 mm
7807	Socket with T-Handle, Hexagon 7 mm
7808	Socket with T-Handle, Hexagon 8 mm
7809	Socket with T-Handle, Hexagon 9 mm
7810	Socket with T-Handle, Hexagon 10 mm
7811	Socket with T-Handle, Hexagon 11 mm
7812	Socket with T-Handle, Hexagon 12 mm
7813	Socket with T-Handle, Hexagon 13 mm
7814	Socket with T-Handle, Hexagon 14 mm



Socket with T-Handle, Hexagon | length 430 mm

- ergonomic T-handle
- satin chrome plated
- additional 6-pt. drive on socket



Item #	Description
8994	Socket with T-Handle, Hexagon length 430 mm 8 mm
8995	Socket with T-Handle, Hexagon length 430 mm 10 mm
8996	Socket with T-Handle, Hexagon length 430 mm 13 mm



Socket Set, Hexagon | 6.3 mm (1/4") drive | 4 - 14 mm | 13 pcs.

6.3 1/4

- knurled
- on socket rail
- Socket set, drive 6.3 mm (1/4") drive, hexagon: 4 - 4.5 - 5 - 5.5 - 6 - 7 - 8 - 9 - 10 - 11 - 12 - 13 - 14 mm
- profile: chrome plated
- surface finish: satin chrome-plated



Item #
9102



Socket Set, Hexagon, deep | 6.3 mm (1/4") drive | 4-13 mm | 11 pcs.

6.3 1/4

- knurled
- on socket rail
- Pro torque® sockets, 6.3 mm (1/4") drive: sizes: 4 - 5 - 5.5 - 6 - 7 - 8 - 9 - 10 - 11 - 12 - 13 mm
- length: 50 mm
- surface finish: satin chrome plated



Item #
2221



Socket Set, 12-point | 6.3 mm (1/4") drive | 4 - 14 mm | 13 pcs.

6.3 1/4

- knurled
- on socket rail
- 12-point socket, 6.3 mm (1/4") drive: 4 - 4.5 - 5 - 5.5 - 6 - 7 - 8 - 9 - 10 - 11 - 12 - 13 - 14 mm
- surface finish: satin chrome-plated



Item #
2269



Socket Set, 12-point, deep | 6.3 mm (1/4") drive | 4 - 13 mm | 11 pcs.

6.3  1/4

- on socket rail
- knurled
- 12-point socket, 6.3 mm (1/4") drive: 4 - 5 - 5.5 - 6 - 7 - 8 - 9 - 10 - 11 - 12 - 13 mm
- profile: 12-point
- surface finish: satin chrome-plated



Item #
5251



Socket Set, Hexagon | 6.3 mm (1/4") drive | Inch sizes | 11 pcs.

6.3  1/4

- knurled
- on socket rail
- Pro torque® sockets, 6.3 mm (1/4") drive: 3/16" - 7/32" - 1/4" - 9/32" - 5/16" - 11/32" - 3/8" - 13/32" - 7/16" - 15/32" - 1/2"
- surface finish: satin chrome-plated



Item #
2433

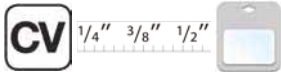

Socket Set, Hexagon, deep | 6.3 mm (1/4") drive | Inch sizes | 11 pcs.

6.3  1/4

- knurled
- on socket rail
- Pro torque® sockets, 6.3 mm (1/4") drive: 3/16" - 7/32" - 1/4" - 9/32" - 5/16" - 11/32" - 3/8" - 13/32" - 7/16" - 15/32" - 1/2"
- surface finish: satin chrome plated



Item #
2429

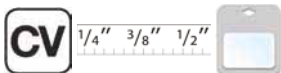

Socket Set, 12-point | 6.3 mm (1/4") drive | Inch sizes | 12 pcs.

6.3  1/4

- knurled
- on socket rail
- 12-point socket, 6.3 mm (1/4") drive: 5/32" - 3/16" - 7/32" - 1/4" - 9/32" - 5/16" - 11/32" - 3/8" - 7/16" - 15/32" - 1/2" - 9/16"
- surface finish: satin chrome-plated



Item #
2755

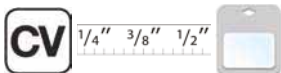

Socket Set, 12-point, deep | 6.3 mm (1/4") drive | Inch sizes | 12 pcs.

6.3  1/4

- knurled
- 12-point socket, 6.3 mm (1/4") drive: 5/32" - 3/16" - 7/32" - 1/4" - 9/32" - 5/16" - 11/32" - 3/8" - 7/16" - 15/32" - 1/2" - 9/16"
- surface finish: satin chrome-plated



Universal Joint Socket Set | 6.3 mm (1/4") | 5 - 13 mm | 10 pcs.

6.3  1/4

- on socket rail
- Universal Joint Sockets 5 - 5.5 - 6 - 7 - 8 - 9 - 10 - 11 - 12 - 13
- surface finish: polished chrome metal



Socket Set, Gear Lock | 6.3 mm (1/4") drive | 13 pcs.

6.3  1/4

- knurled
- on socket rail
- the special „gear-lock-profile“ can be used for hex., double hex., E-Type, metric and inch size screws
- suitable for both 6-pt. and 12-point sockets
- sockets gear lock, 6.3 mm (1/4") drive: 4 - 4.5 - 5 - 5.5 - 6 - 7 - 8 - 9 - 10 - 11 - 12 - 13 - 14 mm
- suitable for E-type (for Torx) screw heads: E5 - E18
- suitable for inch sizes: 5/32" - 1/2"



Socket Set, E-Type | 6.3 mm (1/4") / 10 mm (3/8") drive | E6 - E16 | 7 pcs.

6.3  1/4

- knurled
- E-type socket, 6.3 mm (1/4") / 10 mm (3/8") drive: E6 - E7 - E8 - E10 - E12 - E14 - E16
- surface finish: satin chrome-plated



Socket Set, E-Type | 6.3 mm (1/4") / 10 mm (3/8") drive | E4 - E20 | 12 pcs.

6.3  1/4

- knurled
- E-type socket, 6.3 mm (1/4") drive: E4 - E5 - E6 - E7 - E8
- E-type socket, 10 mm (3/8") drive: E10 - E11 - E12 - E14 - E16 - E18 - E20
- surface finish: satin chrome-plated



Item #
2038



Socket Set, E-Type, deep | 6.3 mm (1/4") drive | E4 - E10 | 6 pcs.

6.3  1/4

- knurled
- on socket rail
- E-type socket, length: 50 mm, 6.3 mm (1/4") drive: E4 - E5 - E6 - E7 - E8 - E10



Item #
6403



Socket Set, Hexagon | 10 mm (3/8") drive | 8 - 19 mm | 12 pcs.

10  3/8

- knurled
- on socket rail
- socket set, 10 mm (3/8") drive: 8 - 9 - 10 - 11 - 12 - 13 - 14 - 15 - 16 - 17 - 18 - 19 mm
- profile: hexagon
- surface finish: satin chrome-plated



Item #
9104



Socket Set, Hexagon, deep | 10 mm (3/8") drive | 8 - 19 mm | 11 pcs.

10  3/8

- knurled
- on socket rail
- Pro torque® sockets, 10 mm (3/8") drive: 8 - 10 - 11 - 12 - 13 - 14 - 15 - 16 - 17 - 18 - 19 mm
- surface finish: satin chrome-plated



Item #
2222



Socket Set, 12-point | 10 mm (3/8") drive | 8 - 19 mm | 12 pcs.

10  3/8

- knurled
- on socket rail
- 10 mm (3/8") drive , 12-point sockets: 8 - 9 - 10 - 11 - 12 - 13 - 14 - 15 - 16 - 17 - 18 - 19 mm
- profile: 12-point
- surface finish: satin chrome-plated



Item #	 
9105	

Socket Set, 12-point, deep | 10 mm (3/8") drive | 8 - 19 mm | 11 pcs.

10  3/8

- on socket rail
- knurled
- 12-point sockets, 10 mm (3/8") drive: sizes: 8 - 10 - 11 - 12 - 13 - 14 - 15 - 16 - 17 - 18 - 19 mm
- profile: 12-point
- surface finish: satin chrome-plated



Item #	 
5252	

Socket Set, Hexagon | 10 mm (3/8") drive | 5/16" - 7/8" | 11 pcs.

10  3/8

- knurled
- on socket rail
- socket set, 10 mm (3/8") drive, hexagon: 5/16" - 1/32" - 3/8" - 7/16" - 1/2" - 9/16" - 5/8" - 11/16" - 3/4" - 13/16" - 7/8"
- profile: chrome plated
- surface finish: satin chrome-plated



Item #	  
9110	

Socket Set, Hexagon, deep | 10 mm (3/8") drive | Inch sizes | 11 pcs.

10  3/8

- knurled
- on socket rail
- Pro torque® sockets, 10 mm (3/8") drive: 5/16" - 11/32" - 3/8" - 7/16" - 1/2" - 9/16" - 5/8", 11/16" - 3/4" - 13/16" - 7/8"
- surface finish: satin chrome-plated



Item #	  
2756	

Socket Set, 12-point | 10 mm (3/8") drive | Inch sizes | 11 pcs.

10  3/8

- knurled
- on socket rail
- Socket set, 10 mm (3/8") drive, 12-point: 5/16" - 1/32" - 3/8" - 7/16" - 1/2" - 9/16" - 5/8" - 11/16" - 3/4" - 13/16" - 7/8"
- profile: 12-point
- surface finish: satin chrome-plated



Item #	  
9112	

Universal Joint Socket Set, Hexagon | 10 mm (3/8") drive | 10 - 19 mm | 10 pcs.

- single sizes available under BGS 2450-2459
- on socket rail
- Universal joint socket set, 10 mm (3/8") drive: 10 - 11 - 12 - 13 - 14 - 15 - 16 - 17 - 18 - 19 mm
- profile: Pro Torque® (hexagon)



Item #	 
205	

Socket Set, Hexagon | 12.5 mm (1/2") drive | 10 - 21 mm | 11 pcs.

12.5  1/2

- knurled
- on socket rail
- Socket set, drive 12.5 mm (1/2") drive: 10 - 11 - 12 - 13 - 14 - 15 - 16 - 17 - 18 - 19 - 21 mm
- profile: hexagon
- surface finish: satin chrome-plated



Item #	
9106	

Socket Set, Hexagon | 12.5 mm (1/2") drive | 20 - 32 mm | 7 pcs.

12.5  1/2

- knurled
- on socket rail
- Socket set, drive 12.5 mm (1/2") drive: 20 - 21 - 22 - 24 - 27 - 30 - 32 mm
- profile: hexagon
- surface finish: satin chrome-plated



Item #	 
9108	

Socket Set, Hexagon, deep | 12.5 mm (1/2") drive | 10 - 24 mm | 9 pcs.

12.5  1/2

- knurled
- Pro torque® sockets, 12.5 mm (1/2") drive, , hexagon: 10 - 13 - 15 - 16 - 17 - 18 - 19 - 22 - 24 mm
- surface finish: satin chrome-plated

Item #
2223



Socket Set, Hexagon | 12.5 mm (1/2") drive | Inch sizes | 10 pcs.

12.5  1/2

- knurled
- on socket rail
- Socket set, 12.5 mm (1/2") drive, hexagon: 3/8" - 7/16" - 1/2" - 9/16" - 5/8" - 11/16" - 3/4" - 13/16" - 7/8" - 15/16"
- profile: hexagon
- surface finish: satin chrome-plated

Item #
9113



Socket Set, Hexagon | 12.5 mm (1/2") drive | Inch sizes | 10 pcs.

12.5  1/2

- knurled
- Pro torque® sockets, 12.5 mm (1/2") drive: 3/8" - 7/16" - 1/2" - 9/16" - 5/8" - 11/16" - 3/4" - 13/16" - 7/8" - 15/16"
- surface finish: satin chrome-plated

Item #
2434

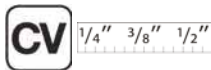

Socket Set, Hexagon | 6.3 mm (1/4") + 12.5 mm (1/2") drives | Inch sizes | 23 pcs.

6.3  1/4

12.5  1/2

- knurled
- Sockets hexagon, 6.3 mm (1/4") drive: 5/32" - 3/16" - 7/32" - 1/4" - 9/32" - 5/16" - 11/32" - 3/8" - 7/16" - 15/32"
- Sockets hexagon, 12.5 mm (1/2") drive: 1/2" - 9/16" - 19/32" - 5/8" - 11/16" - 3/4" - 13/16" - 7/8" - 15/16" - 1" - 1.1/16" - 1.1/8" - 1.1/4"
- surface finish: satin chrome plated

Item #
2246

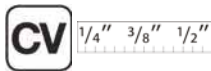

Socket Set, Hexagon, deep | 12.5 mm (1/2") drive | Inch sizes | 10 pcs.

12.5  1/2

- on socket rail
- knurled
- Pro torque® sockets, 12.5 mm (1/2") drive: 3/8" - 7/16" - 1/2" - 9/16" - 5/8" - 11/16" - 3/4" 13/16" - 7/8" - 15/16"
- surface finish: satin chrome-plated



Socket Set, 12-point | 12.5 mm (1/2") drive | 10 - 21 mm | 11 pcs.

12.5  1/2

- knurled
- on socket rail
- Socket set, 12.5 mm (1/2") drive, 12-point: sizes: 10 - 11 - 12 - 13 - 14 - 15 - 16 - 17 - 18 - 19 - 21 mm
- profile: 12-point
- surface finish: satin chrome-plated



Socket Set, 12-point | 12.5 mm (1/2") drive | 20 - 32 mm | 7 pcs.

12.5  1/2

- knurled
- on socket rail
- Socket set, 12.5 mm (1/2") drive, 12-point 20 - 21 - 22 - 24 - 27 - 30 - 32 mm
- profile: 12-point
- surface finish: satin chrome-plated



Socket Set, 12-point | 12.5 mm (1/2") drive | 8 - 24 mm | 16 pcs.

12.5  1/2

- knurled
- 12-point sockets, 12.5 mm (1/2") drive: 8 - 9 - 10 - 11 - 12 - 13 - 14 - 15 - 16 - 17 - 18 - 19 - 20 - 21 - 22 - 24 mm
- surface finish: satin chrome-plated



Socket Set, 12-point | 12.5 mm (1/2") drive | 8 - 36 mm | 21 pcs.

12.5  1/2

- knurled
- Sockets, 12.5 mm (1/2") drive: 8 - 9 - 10 - 11 - 12 - 13 - 14 - 15 - 16 - 17 - 18 - 19 - 20 - 21 - 22 - 24 - 27 - 30 - 32 - 34 - 36 mm
- surface finish: satin chrome plated



Item #
2267



Socket Set, 12-point, deep | 12.5 mm (1/2") drive | 10 - 24 mm | 9 pcs.

12.5  1/2

- on socket rail
- knurled
- Socket set, 12.5 mm (1/2") drive, 12-point: 10 - 13 - 15 - 16 - 17 - 18 - 19 - 22 - 24 mm
- profile: 12-point
- surface finish: satin chrome-plated



Item #
5253



Socket Set, 12-point | 12.5 mm (1/2") drive | Inch sizes | 10 pcs.

12.5  1/2

- knurled
- on socket rail
- Socket set, 12.5 mm (1/2") drive, 12-point: 3/8" - 7/16" - 1/2" - 9/16" - 5/8" - 11/16" - 3/4" - 13/16" - 7/8" - 15/16"
- profile: 12-point
- surface finish: satin chrome-plated



Item #
9114

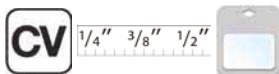

Sales Display, fully equipped with Sockets / Bit Sockets

12.5  1/2

- 315 pcs. display with 12.5 mm (1/2") Super Lock sockets & bit sockets
- with EPE for top tray, prevents the bit sockets from falling out
- all sockets knurled
- display dimensions (D x W x H) 335 x 410 x 270 mm
- bit sockets, length: 100 mm, internal hexagon: (7 pcs. each size) 7 - 8 - 10 - 12 mm
- bit sockets, length: 100 mm, spline (for XZN): (7 pcs. each size) M8 - M10 - M12 - M14
- bit sockets, length: 100 mm, T-Star (for Torx): (7 pcs. each size) T25 - T30 - T40 - T45 - T50
- Sockets Super Lock: (15 pcs. per size) 21 / 22 mm
- Sockets Super Lock: (10 pcs. per size) 8 - 9 - 11 - 12 - 14 - 15 - 16 - 24 - 32 mm
- Sockets Super Lock: (8 pcs. per size) 27 / 30 mm
- Sockets Super Lock: (20 pcs. each size) 10 - 13 17 - 19 mm
- Sockets Super Lock: (8 pcs.) 18 mm



Item #
4095



Socket Set, E-Type | 12.5 mm (1/2") drive | E10 - E24 | 9 pcs.

12.5  1/2

- knurled
- E-type socket, 12.5 mm (1/2") drive: E10 - E11 - E12 - E14 - E16 - E18 - E20 - E22 - E24
- profile: E-type
- surface finish: satin chrome-plated



Item #
6425



Socket Set, E-Type, deep | 12.5 mm (1/2") drive | E10 - E24 | 9 pcs.

12.5  1/2

- knurled
- E-type sockets, length: approx. 80 mm, 12.5 mm (1/2") drive: E10 - E11 - E12 - E14 - E16 - E18 - E20 - E22 - E24
- surface finish: satin chrome-plated



Item #
2026



Socket Set, T-Star Plus (for Torx Plus) | 12.5 mm (1/2") drive | 18EP - 32EP | 8 pcs. 12.5 □ 1/2

- on socket rail
- T-profile Plus sockets, 12.5 mm (1/2") drive: 18EP - 20EP - 22EP - 24EP - 26EP - 28EP - 30EP - 32EP
- surface finish: polished chrome metal



Socket Set, Gear Lock | 12.5 mm (1/2") drive | 19 pcs. 12.5 □ 1/2

- the special „gear-lock-profile“ can be used for hex., double hex., T-STAR, metric and inch size screws
- suitable for both 6-pt. and 12-point screws
- knurled
- 8 - 9 - 10 - 11 - 12 - 13 - 14 - 15 - 16 - 17 - 18 - 19 - 20 - 21 - 22 - 24 - 27 - 30 - 32 mm

also suitable for:

- E-type: E10 - E12 - E14 - E16 - E18 - E20 - E22 - E24
- Inch sizes: 5/16" - 11/32" - 3/8" - 7/16" - 15/32" - 1/2" - 9/16" - 19/32" - 5/8" - 3/4" - 25/32" - 13/16" - 7/8" - 15/16" - 1-1/16" - 1-3/16" - 1-1/4"



Impact Socket Set, Hexagon | 12.5 mm (1/2") drive | 10 - 24 mm | 10 pcs. 12.5 □ 1/2

- for both manual and impact wrenches
- can be fixed on impact wrench by pin and O-ring
- Impact sockets, 12.5 mm (1/2") drive: 10 - 12 - 13 - 14 - 15 - 17 - 19 - 21 - 22 - 24 mm
- profile: hexagon
- length: 38 mm



Sockets

Impact Socket Set, Hexagon, deep | 12.5 mm (1/2") drive | 10 - 24 mm | 10 pcs. 12.5 1/2

- for both manual and impact wrenches
- can be fixed on impact wrench by pin and O-ring
- Impact sockets, 12.5 mm (1/2") drive:
10 - 12 - 13 - 14 - 15 - 17 - 19 - 21 - 22 - 24 mm



Item #
5206



Impact Socket Set, Hexagon | 12.5 mm (1/2") drive | 10 - 32 mm | 14 pcs. 12.5 1/2

- for both manual and impact wrenches
- can be fixed on impact wrench by pin and O-ring
- length: approx. 75 mm
- impact sockets, 12.5 mm (1/2") drive:
10 - 12 - 13 - 14 - 15 - 17 - 18 - 19 - 21 - 22 - 24 - 27 - 30 - 32 mm
- length: 75 mm



Item #
5207



Impact Socket Set, Hexagon, extra flat | 12.5 mm (1/2") drive | 13 - 24 mm | 9 pcs. 12.5 1/2

- suitable for both manual and impact wrenches
- can be fixed on impact wrench by pin and O-ring
- extra flat
- on socket rail
- Impact sockets, 12.5 mm (1/2") drive,
13 - 14 - 15 - 16 - 17 - 18 - 19 - 21 - 24 mm
- length: 28 mm



Item #
9551



Impact Socket Set, Hexagon, extra flat | 12.5 mm (1/2") drive | 8 - 24 mm | 17 pcs. 12.5 □ 1/2

- for both manual and impact wrenches
- can be fixed on impact wrench by pin and O-ring
- extra flat
- Impact sockets, 12.5 mm (1/2") drive:
8 - 9 - 10 - 11 - 12 - 13 - 14 - 15 - 16 - 17 - 18 - 19 - 20 - 21 - 22 - 23 - 24 mm
- profile: chrome plated



Item #	CRO MO
9286	

Impact Ball Joint Socket Set | 12.5 mm (1/2") drive | 4 pcs. 12.5 □ 1/2

- suitable for both manual and impact wrenches
- can be fixed on impact wrench by pin and O-ring
- sizes: 16 - 17 - 18 - 19 mm
- single sizes available under BGS 5200-16, 5200-17, 5200-18, 5200-19
- Impact ball joint socket, 12.5 mm (1/2") drive 16 mm
- Impact ball joint socket, 12.5 mm (1/2") drive 17 mm
- Impact ball joint socket, 12.5 mm (1/2") drive 18 mm
- Impact ball joint socket, 12.5 mm (1/2") drive 19 mm
- profile: hexagon
- length: 65 mm



Item #	CRO MO
5200	

Drive Shaft Socket Set | 6 pcs. 12.5 □ 1/2

- with groove and hole for retaining ball
- 12-point sockets, 12.5 mm (1/2") drive: 30 - 32 - 36 mm
- bit sockets, 12.5 mm (1/2") drive, internal hexagon: 14 - 17 - 19 mm



Item #	CRO MO
5334	

Sockets

Drive Shaft Socket Set | 27 - 36 mm | 8 pcs.

12.5 mm 1/2"

- with groove and hole for retaining ball
- 12-point sockets, 12.5 mm (1/2") drive: 27 - 30 - 32 - 34 - 36
- bit sockets, 12.5 mm (1/2") drive, internal hexagon: 14 - 17 - 19 mm



Item #
5335



Impact Socket Set Gear Lock | 12.5 mm (1/2") drive | 10 - 32 mm | 14 pcs.

12.5 mm 1/2"

- for both manual and impact wrenches
- can be fixed on impact wrench by pin and O-ring
- suitable for metric and inch sizes, hexagon-, 12-point and E-type screws
- Impact sockets, gear lock, 12.5 mm (1/2") drive:
10 12 - 13 - 14 - 15 - 17 - 18 - 19 - 21 - 22 - 24 - 27 - 30 - 32 mm



Item #
5209



Impact Socket Set E-Type, deep | 12.5 mm (1/2") drive | E10 - E24 | 9 pcs.

12.5 mm 1/2"

- for both manual and impact wrenches
- can be fixed on impact wrench by pin and O-ring
- single sizes available under BGS 5204-10, 5204-11, 5204-12, 5204-14, 5204-16, 5204-18, 5204-20, 5204-22, 5204-24
- Impact sockets, 12.5 mm (1/2") drive, E-type:
E10 - E11 - E12 - E14 - E16 - E18 - E20 - E22 - E24



Item #
5204



Impact Socket Set, Hexagon, deep | 12.5 mm (1/2") drive | Inch sizes | 13 pcs. 12.5 \square 1/2

- for both manual and impact wrenches
- can be fixed on impact wrench by pin and O-ring
- Impact socket: 7/16"
- Impact socket: 1/2"
- Impact socket: 9/16"
- Impact socket: 4/8"
- Impact socket: 11/16"
- Impact socket: 3/4"
- Impact socket: 13/16"
- Impact socket: 7/8"
- Impact socket: 15/16"
- Impact socket: 1"
- Impact socket: 1 1/16"
- Impact socket: 1 1/8"
- Impact socket: 1 1/4"
- profile: hexagon
- length: 75 mm
- surface finish: phosphated



Sockets

Item #	 
5208	

Socket Set, E-Type, extra long | 12.5 mm (1/2") drive | E10 - E20 | 6 pcs. 12.5 \square 1/2

- length 140 mm
- E10 - E12 - E14 - E16 - E18 - E20
- with locking ball
- E12 x 150 mm for BMW cylinder head also available separately under BGS 2020



Item #	 
2028	

Protective Impact Socket Set | 12.5 mm (1/2") drive | 17 / 19 / 21 mm | 3 pcs. 12.5 \square 1/2

- for both manual and impact wrenches
- can be fixed on impact wrench by pin and O-ring
- plastic cover and plastic sleeve for protection of aluminium rims
- coloured coded sockets help to indicate the right size
- single size sockets available under BGS 7201, 7202, 7203
- single sizes covers under BGS 7204, 7205, 7206
- Protective Impact Sockets, 12.5 mm (1/2") drive:
 - 17 - 19 - 21 mm
- length: 85 mm



Item #	 
7200	

Protective Impact Socket Set | 12.5 mm (1/2") drive | 17 / 19 / 21 mm | 3 pcs. 12.5 □ 1/2

- for both manual and impact wrenches
- can be fixed on impact wrench by pin and O-ring
- plastic cover and plastic sleeve for protection of aluminium rims
- colored plastic covers help to indicate the right size
- single sockets available under BGS 7301, 7302, 7303
- single covers available under BGS 7304, 7305, 7306
- Protective Impact Socket, 12.5 mm (1/2") drive:
 - 17 - 19 - 21 mm
 - length: 85 mm



Item #	CRO MO
7300	

Protective Impact Socket Set | 12.5 mm (1/2") drive | 6 pcs. 12.5 □ 1/2

- for both manual and impact wrenches
- can be fixed on impact wrench by pin and O-ring
- plastic cover and plastic sleeve for protection of aluminium rims
- coloured sockets help to indicate the right size
- includes MS17 special socket for the latest generation of Mercedes wheel nuts
- single sizes available under BGS 7201, 7202, 7203, 7207, 7208, 7309
- spare plastic protection cover available under BGS 7204, 7205, 7206, 7209, 7198
- Protective Impact Sockets, 12.5 mm (1/2") drive:
 - 15 - 17 - 19 - 21 - 22 mm
- MS17 special socket for Mercedes wheel nuts, 12.5 mm (1/2") drive
- length: 85 mm



Item #	CRO MO
7307	

Protective Impact Socket Set | 12.5 mm (1/2") drive | 150 mm deep | 17 / 19 / 21 mm | 3 pcs. 12.5 □ 1/2

- for both manual and impact wrenches
- can be fixed on impact wrench by pin and O-ring
- plastic cover and plastic sleeve for protection of aluminium rims
- coloured plastic covers help to indicate the right size
- extra long for deep centre rims
- single sockets available under BGS 7101, 7102, 7103
- single covers available under BGS 7204, 7205, 7206
- Protective Impact Socket, 12.5 mm (1/2") drive:
 - 17 - 19 - 21 mm
 - length: 150 mm



Item #	CRO MO
7100	

Impact Socket Set | 20 mm (3/4") drive | 22 - 38 mm | 8 pcs.

20  3/4

- for both manual and impact wrenches
- can be fixed on impact wrench by pin and O-ring
- short type
- impact sockets, length 56 mm, 20 mm (3/4") drive:
22 - 24 - 27 - 28 - 30 - 32 - 36 - 38 mm



Item #
5240



Impact Socket Set | 20 mm (3/4") drive | 19 - 55 mm | 17 pcs.

20  3/4

- for both manual and impact wrenches
- can be fixed on impact wrench by pin and O-ring
- impact sockets, 20 mm (3/4") drive:
 - external Ø max. 38 mm, length 51 mm, 19 mm
 - external Ø max. 40 mm, length 51 mm, 21 mm
 - external Ø max. 40 mm, length 51 mm, 22 mm
 - external Ø max. 40 mm, length 51 mm, 24 mm
 - external Ø max. 40 mm, length 54 mm, 27 mm
 - external Ø max. 46 mm, length 54 mm, 30 mm
 - external Ø max. 48 mm, length 57 mm, 32 mm
 - external Ø max. 50 mm, length 57 mm, 33 mm
 - external Ø max. 52 mm, length 57 mm, 34 mm
 - external Ø max. 52 mm, length 57 mm, 35 mm
 - external Ø max. 54 mm, length 57 mm, 36 mm
 - external Ø max. 56 mm, length 57 mm, 38 mm
 - external Ø max. 58 mm, length 57 mm, 40 mm
 - external Ø max. 60 mm, length 57 mm, 41 mm
 - external Ø max. 66 mm, length 63 mm, 46 mm
 - external Ø max. 71 mm, length 68 mm, 50 mm
 - external Ø max. 77 mm, length 73 mm, 55 mm



Item #
5242



Impact Socket Set, extra deep | 20 mm (3/4") drive | 22 - 38 mm | 8 pcs.

20  3/4

- for both manual and impact wrenches
- can be fixed on impact wrench by pin and O-ring
- Impact sockets, length: 90 mm, 20 mm (3/4") drive:
22 - 24 - 27 - 28 - 30 - 32 - 36 - 38 mm



Item #
5241



Impact Socket Set E-Type, 12-point | 20 mm (3/4") drive | 6 pcs.

20  3/4

- suitable for impact wrenches, length 110 mm
- suitable for truck cylinder head screws, e.g. MB 300-400-420-500-900; MAN M 2000, F90, F8, D20, D25, D28
- E-type impact sockets, 20 mm (3/4") drive: E18 - E20 - E22 - E24
- 12-point impact sockets, 20 mm (3/4") drive: 17 + 19 mm
- length: 110 mm



Item #
5250



Impact Socket Set, Hexagon | 25 mm (1") drive | 27 - 50 mm | 8 pcs.

25  1

- for both manual and impact wrenches
- can be fixed on impact wrench by pin and O-ring
- in metal case with convenient carrying handle
- impact sockets, 25 mm (1") drive:
27 - 30 - 32 - 36 - 38 - 41 - 46 - 50 mm



Item #
5245



Impact Socket Set, Hexagon, deep | 25 mm (1") drive | 27 - 50 mm | 8 pcs.

25  1

- for both manual and impact wrenches
- can be fixed on impact wrench by pin and O-ring
- Impact socket, length: 90 mm, 25 mm (1") drive:
27 - 30 - 32 - 36 - 38 - 41 - 46 - 50 mm



Item #
5500



Bit Socket Set | 49 pcs.

12.5mm  1/2"

Item #
5188



CV 





Bit Socket Set

Set Contents



Item #	Description
293	Bit Adaptor with retaining Ball 12.5 mm (1/2") Drive internal Hexagon 8 mm (5/16")

12.5mm  1/2"  



Item #	Description
4369	T20 x 55mm
4370	T25 x 55mm
4367	T27 x 55mm
4371	T30 x 55mm
4372	T40 x 55mm
4373	T45 x 55mm
4374	T50 x 55mm
4375	T55 x 55mm
4378	T60 x 55mm
4379	T70 x 55mm
4470	T25 x 100mm
4471	T30 x 100mm
4472	T40 x 100mm
4473	T45 x 100mm
4474	T50 x 100mm
4476	T60 x 100mm

12.5mm  1/2"  

Item #	Description
4251	H5 x 55mm
4252	H6 x 55mm
4253	H7 x 55mm
4254	H8 x 55mm
4255	H10 x 55mm
4256	H12 x 55mm
4257	H14 x 55mm
5184-H17	H17 x 55mm
5184-H19	H19 x 55mm
4261	H6 x 100mm
4262	H7 x 100mm
4263	H8 x 100mm
4264	H10 x 100mm
4265	H12 x 100mm

12.5mm  1/2"  

Item #	Description
4350	M5 x 55mm
4351	M6 x 55mm
4352	M8 x 55mm
4353	M10 x 55mm
4360	M6 x 100mm
4361	M8 x 100mm
4362	M10 x 100mm
4363	M12 x 100mm
4364	M14 x 100mm

8mm  5/16" 

Item #	Description
4420	T20 x 30mm
4425	T25 x 30mm
4427	T27 x 30mm
4430	T30 x 30mm
4440	T40 x 30mm
4445	T45 x 30mm
4450	T50 x 30mm
4455	T55 x 30mm
4460	T60 x 30mm

Bit Socket Set | special automotive Sizes | 38 pcs.

6.3_m □ 1/4" 12.5_m □ 1/2"

Item #
5184

CV

CV-S2
100%



Bit Socket Set

6.3_m □ 1/4" 

Item #	Description
5184-TS10	TS 10 x 38 mm
5184-TS15	TS 15 x 38 mm
5184-TS20	TS 20 x 38 mm
5184-TS25	TS 25 x 38 mm
5184-TS27	TS 27 x 38 mm
5184-TS30	TS 30 x 38 mm
5184-TS40	TS 40 x 38 mm
5184-TS45	TS 45 x 38 mm
5184-TS50	TS 50 x 38 mm

12.5_m □ 1/2" 

Item #	Description
5184-R7	R7 x 240 mm
5184-R8	R8 x 240 mm
5184-R9	R9 x 100 mm
5184-R10	R10 x 140 mm

12.5_m □ 1/2" 

Item #	Description
5184-T40	T40 x 140 mm
5184-T45	T45 x 140 mm
5184-T50	T50 x 140 mm
5184-T55	T55 x 140 mm
5184-T60	T60 x 140 mm
5184-T70	T70 x 140 mm

12.5_m □ 1/2" 

Item #	Description
5184-H7	H7 x 230 mm
5184-H10	H10 x 140 mm
5184-H11	H11 x 140 mm
5184-H13	H13 x 140 mm
4257	H14 x 55 mm
5184-H17	H17 x 55 mm
5184-H19	H19 x 55 mm
5184-H22	H22 x 55 mm
5184-H24	H24 x 55 mm

12.5_m □ 1/2" 

Item #	Description
5184-M9	M9 x 100 mm
5184-M10	M10 x 140 mm
5184-M12	M12 x 140 mm
5184-M14	M14 x 140 mm

12.5_m □ 1/2" 

Item #	Description
4356	Bit Socket Spline tamperproof (for XZN) M16
4357	Bit Socket length 100 mm Spline tamperproof (for XZN) M16
5184-M18	Bit Socket length 78 mm Spline (for XZN) M18
5184-TB80	Bit Socket length 100 mm T-Star tamperproof (for Torx) T80
5184-TB30	Bit Socket length 300 mm T-Star tamperproof (for Torx) T30
5184-HB5	Bit Socket length 160 mm internal Hexagon with ball point 5 mm

Impact Bit Socket Set | 27 pcs.



12.5mm 1/2"

Item #
5484



CRO
MO





Bit Socket Set

12.5mm 1/2"  

Item #	Description
5481-M5	H5 x 75mm
5481-M6	H6 x 75mm
5481-M7	H7 x 75mm
5481-M8	H8 x 75mm
5481-M10	H10 x 75mm
5481-M12	H12 x 75mm
5481-M14	H14 x 75mm
5481-M17	H17 x 75mm
5481-M19	H19 x 75mm

12.5mm 1/2"  

Item #	Description
5480-T25	T25 x 75mm
5480-T30	T30 x 75mm
5480-T40	T40 x 75mm
5480-T45	T45 x 75mm
5480-T50	T50 x 75mm
5480-T55	T55 x 75mm
5480-T60	T60 x 75mm
5480-T70	T70 x 75mm
	T80 x 75mm

12.5mm 1/2"  

Item #	Description
5482-M5	M5 x 75mm
5482-M6	M6 x 75mm
5482-M8	M8 x 75mm
5482-M9	M9 x 75mm
5482-M10	M10 x 75mm
5482-M12	M12 x 75mm
5482-M14	M14 x 75mm
5482-M16	M16 x 75mm
5184-M18	M18 x 78mm

Bit SocketSet | for Cylinder Head Screws | 12.5 mm (1/2") drive | 9 pcs.

12.5  1/2

- knurled
- composition of all common bit sockets for cylinder head screws
- incl. spline profile for assembling and disassembling VAG polydrive cylinder head bolt screws
- 4 bit sockets, 12.5 mm (1/2") drive, spline (for Ribe): M10 x 165 mm - M12 x 120 mm - M13 x 120 mm - M14 x 120 mm
- 2 bit sockets, 12.5 mm (1/2") drive, spline (for XZN): M10 x 140 mm - M12 x 140 mm
- 2 bit sockets, 12.5 mm (1/2") drive, T-Star (for Torx): T55 x 140 mm - T70 x 120 mm
- 1 socket, 12.5 mm (1/2") drive, E-type: E12 x 140 mm
- material: chrome vanadium steel



Item #
5014



Tool Tray 1/6: Impact Bit Socket Set | 6.3 mm (1/4") | 40 pcs.

6.3  1/4

- suitable for both manual and impact use
- extra short version
- 10x T-Star (for Torx): T10 - T15 - T20 - T25 - T27 - T30 - T40 - T45 - T47 - T50
- 5x T-Star (for Torx) tamperproof : TH30 - TH40 - TH45 - TH47 - TH50
- 5x Spline (for XZN): M4 - M5 - M6 - M8 - M10
- 4x Spline (for XZN) tamperproof : MH5 - MH6 - MH8 - MH10
- 3x Square (for Robertson): 1 - 2 - 3
- 4x slot SL: 3 mm - 4 mm - 5.5 mm - 7 mm
- 7x internal hexagon: H3 - H4 - H5 - H6 - H7 - H8 - H10
- 4x cross slot PH: PH1 - PH2 - PH3



Item #
9523



Bit Socket Set | 6.3 mm (1/4") drive | Slot SL, Cross Slot PH / PZ | 12 pcs.

6.3  1/4

- knurled
- on socket rail
- bit sockets, 6.3 mm (1/4") drive, drive slot SL 4 - 5.5 - 6.5 - 7 mm
- bit sockets, 6.3 mm (1/4") drive, drive cross slot PH0 - PH1 - PH2 - PH3
- bit sockets, 6.3 mm (1/4") drive, drive cross slot PZ0 - PZ1 - PZ2 - PZ3
- surface finish: satin chrome plated



Item #
2163



Impact Bit Socket Set | 20 mm (3/4") drive | internal Hexagon, internal spline (for XZN) | 9 pcs. **20** **3/4**

- suitable for both manual and impact wrenches
- can be fixed on impact wrench by pin and O-ring
- length: 55 mm

internal hexagon

- Impact bit sockets, 20 mm (3/4") drive, internal hexagon: 14 - 17 - 19 - 21 - 22 - 23 - 24 mm

Spline (for XZN)

- Impact bit sockets, 12.5 mm (1/2") drive, spline drive (for XZN): M16-M18



Item #
5054



Bit Socket Set | 12.5 mm (1/2") drive | internal Hexagon 5 - 22 mm | 12 pcs. **12.5** **1/2**

- knurled
- bit sockets, 12.5 mm (1/2") drive, drive internal hexagon 5 - 6 - 7 - 8 - 10 - 12 - 14 - 16 - 17 - 18 - 19 - 22 mm
- profile: internal hexagon
- surface finish: satin chrome plated



Item #
5052



Bit Socket Set | 12.5 mm (1/2") drive | internal Hexagon | Inch sizes 7/32" - 7/8" | 11 pcs. **12.5** **1/2**

- knurled
- bit sockets, length 55 mm, 12.5 mm (1/2") drive, internal hexagon: 7/32" - 1/4" - 9/32" - 5/16" - 3/8" - 15/32"
- bit sockets, length 70 mm, 12.5 mm (1/2") drive, internal hexagon: 9/16" - 5/8" - 11/16" - 13/16" - 3/4"
- profile: internal hexagon
- surface finish: satin chrome-plated



Item #
5053

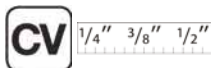

Bit Socket Set | internal Hexagon | 30 pcs.

12.5mm \square 1/2"

Item #
5181

CV

CV-S2

Bit Socket Set

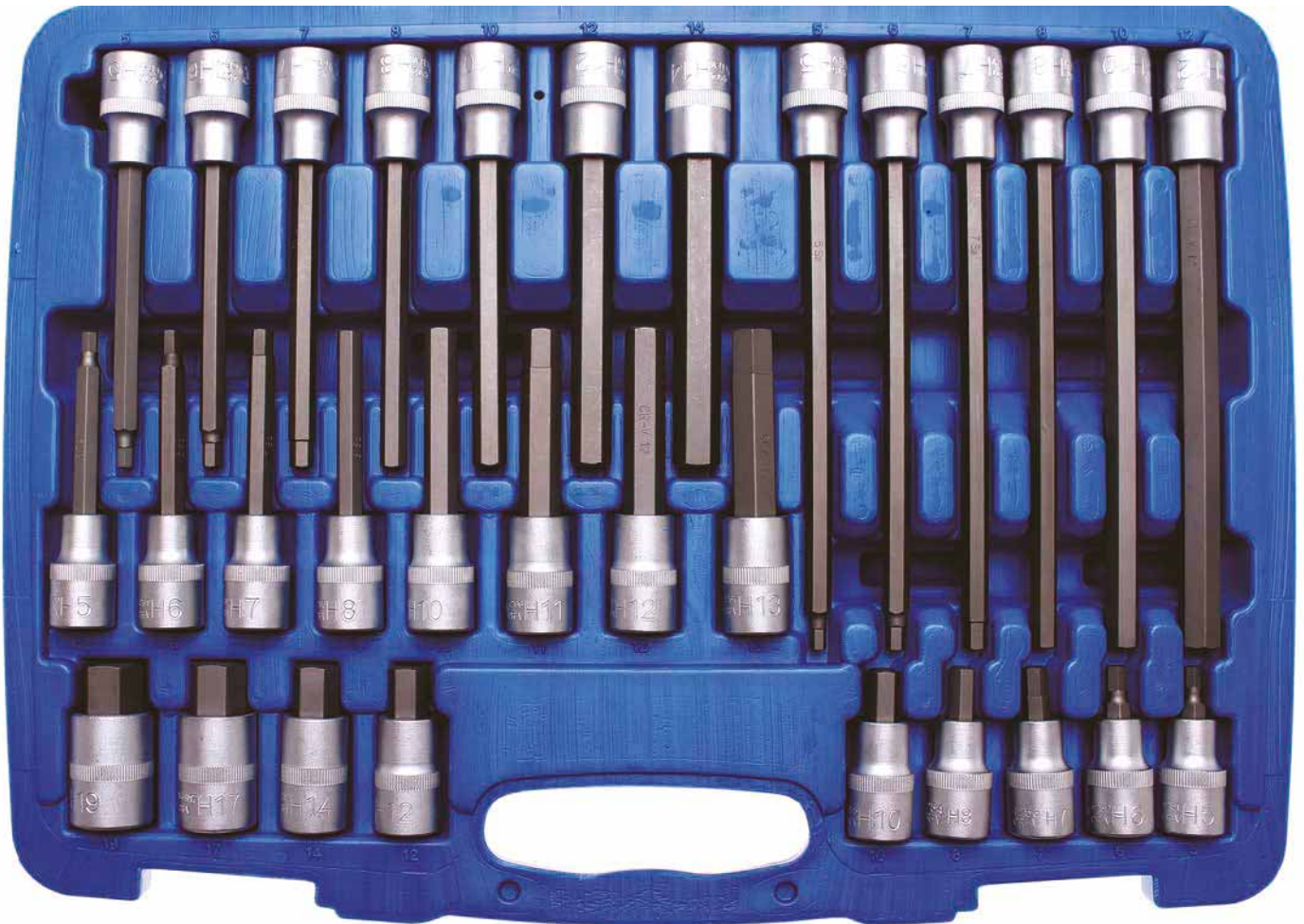

12.5mm \square 1/2" 

Item #	Description
4251	H5 x 55 mm
4252	H6 x 55 mm
4253	H7 x 55 mm
4254	H8 x 55 mm
4255	H10 x 55 mm
4256	H12 x 55 mm
4257	H14 x 55 mm
5184-H17	H17 x 55 mm
5184-H19	H19 x 55 mm
4260	H5 x 100 mm
4261	H6 x 100 mm
4262	H7 x 100 mm
4263	H8 x 100 mm
4264	H10 x 100 mm
4266	H11 x 100 mm
4265	H12 x 100 mm
4267	H13 x 100 mm

12.5mm \square 1/2" 

Item #	Description
4270	H5 x 140 mm
4271	H6 x 140 mm
4217	H7 x 140 mm
4272	H8 x 140 mm
5184-H10	H10 x 140 mm
4273	H12 x 140 mm
4274	H14 x 140 mm
4275	H5 x 200 mm
4276	H6 x 200 mm
4277	H7 x 200 mm
4278	H8 x 200 mm
4279	H10 x 200 mm
4280	H12 x 200 mm

Bit Socket Set | 12.5 mm (1/2") drive | internal Hexagon ball point 5 - 12 mm | 6 pcs. 12.5 \square 1/2

- knurled
- bit sockets, 12.5 mm (1/2") drive, inner hexagon ball point 5 - 6 - 7 - 8 - 10 - 12 mm
- profile: Inner hexagon Ball Point
- length: 140 mm
- surface finish: satin chrome-plated

Item #
4258



Bit Socket Set | extra short | internal Hexagon 4 - 19 mm | 10 pcs. 6.3 \square 1/4 10 \square 3/8 12.5 \square 1/2

- knurled
- on socket rail
- bit sockets, length: 30 mm, 6.3 mm (1/4") drive, internal hexagon 4 - 5 - 6 - 7 - 8 mm
- bit sockets, length: 38 mm, 10 mm (3/8") drive, internal hexagon 10 - 12 - 14 mm
- bit sockets, length: 48 mm, 12.5 mm (1/2") drive, internal hexagon 17 - 19 mm

Item #
5099



Bit Socket Set | 12.5 mm (1/2") drive | internal Hexagon 6 - 14 mm | 6 pcs. 12.5 \square 1/2

- knurled
- Bit sockets, 12.5 mm (1/2") drive, internal hexagon 6 - 7 - 8 - 10 - 12 - 14 mm
- profile: internal hexagon
- surface finish: satin chrome plated

Item #
8887



Impact Bit Socket Set | 12.5 mm (1/2") drive | internal Hexagon 5 - 19 mm | 9 pcs. 12.5 \square 1/2

- suitable for both manual and impact wrenches
- can be fixed on impact wrench by pin and O-ring
- length: 42 mm
- Impact bit sockets, 12.5 mm (1/2") drive, internal hexagon: 5 - 6 - 7 - 8 - 10 - 12 - 14 - 17 - 19 mm

Item #
5485



Impact Bit Socket Set | 12.5 mm (1/2") drive | internal Hexagon 5 - 19 mm | 8 pcs.

- suitable for both manual and impact wrenches
- can be fixed on impact wrench by pin and O-ring
- internal hexagon sizes: 5 - 6 - 8 - 10 - 12 - 14 - 17 - 19 mm
- length 75 mm
- with ball retaining groove
- profile: internal hexagon
- length: 75 mm



Item #	CRO MO
5481	

Bit Socket Set | 10 mm (3/8") drive | internal Hexagon 3 - 10 mm | 7 pcs.

10 3/8

- knurled
- on socket rail
- bit sockets, 10 mm (3/8") drive, internal hexagon 3 - 4 - 5 - 6 - 7 - 8 - 10 mm
- profile: internal hexagon
- surface finish: satin chrome plated



Item #	CV
5107	

Bit Socket Set | 10 mm (3/8") drive | internal Hexagon ball point 3 - 8 mm | 7 pcs.

10 3/8

- ball end hexagon socket for lateral screwing
- knurled
- on socket rail
- bit sockets, length: 50 mm, 10 mm (3/8") drive, inner hexagon ball point 3 - 4 - 5 - 5.5 - 6 - 8 mm
- profile: Inner hexagon Ball Point
- surface finish: satin chrome plated



Item #	CV
5109	

Bit Socket Set | 10 mm (3/8") drive | internal Hexagon 1/8" - 3/8" | Inch sizes | 7 pcs.

10 3/8

- knurled
- for assemblies on British vehicles, classic cars as well as US motorcycles
- on socket rail
- bit sockets, 10 mm (3/8") drive, internal hexagon 1/8" - 5/32" - 3/16" - 7/32" - 1/4" - 5/16" - 3/8"
- profile: internal hexagon
- surface finish: satin chrome plated



Item #	CV
5104	

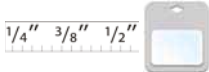

Bit Socket Set | 6.3 mm (1/4") drive | internal Hexagon 4 - 12 mm | 7 pcs.

6.3  1/4

- knurled
- on socket rail
- bit sockets, 6.3 mm (1/4") drive, internal hexagon 4 - 5 - 6 - 7 - 8 - 10 - 12 mm
- profile: internal hexagon
- surface finish: satin chrome-plated

Item #
2161



Bit Socket Set | 6.3 mm (1/4") drive | internal Hexagon 1.5 - 6 mm | 6 pcs.

6.3  1/4

- knurled
- on chrome socket rail
- Bit sockets, 6.3 mm (1/4") drive, internal hexagon 1.5 - 2 - 2.5 - 3.5 - 4 - 6 mm
- profile: internal hexagon
- surface finish: satin chrome plated

Item #
5151



Bit Socket Set | 6.3 mm (1/4") drive | internal Hexagon | Inch sizes 3/32" - 3/8" | 9 pcs.

6.3  1/4

- knurled
- on socket rail
- bit sockets, 6.3 mm (1/4") drive, internal hexagon: 3/32" - 1/8" - 5/32" - 3/16" - 7/32" - 1/4" - 9/32" - 5/16" - 3/8"
- surface finish: satin chrome plated

Item #
2749

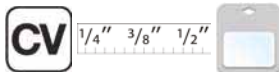

Bit Socket Set | 6.3 mm (1/4") drive | internal Hexagon | Inch sizes | 1/8" - 3/8" | 7 pcs.

6.3  1/4

- knurled
- with chrome plated socket rail
- bit sockets, 6.3 mm (1/4") drive, internal hexagon 1/8" - 5/32" - 3/16" - 7/32" - 1/4" - 5/16" - 3/8"
- profile: internal hexagon
- length: 38 mm
- surface finish: satin chrome plated

Item #
2166

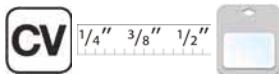

Bit Socket Set | Spline (for XZN) | 26 pcs.

12.5mm  1/2"

Item #
5180

CV 

Bit Socket Set

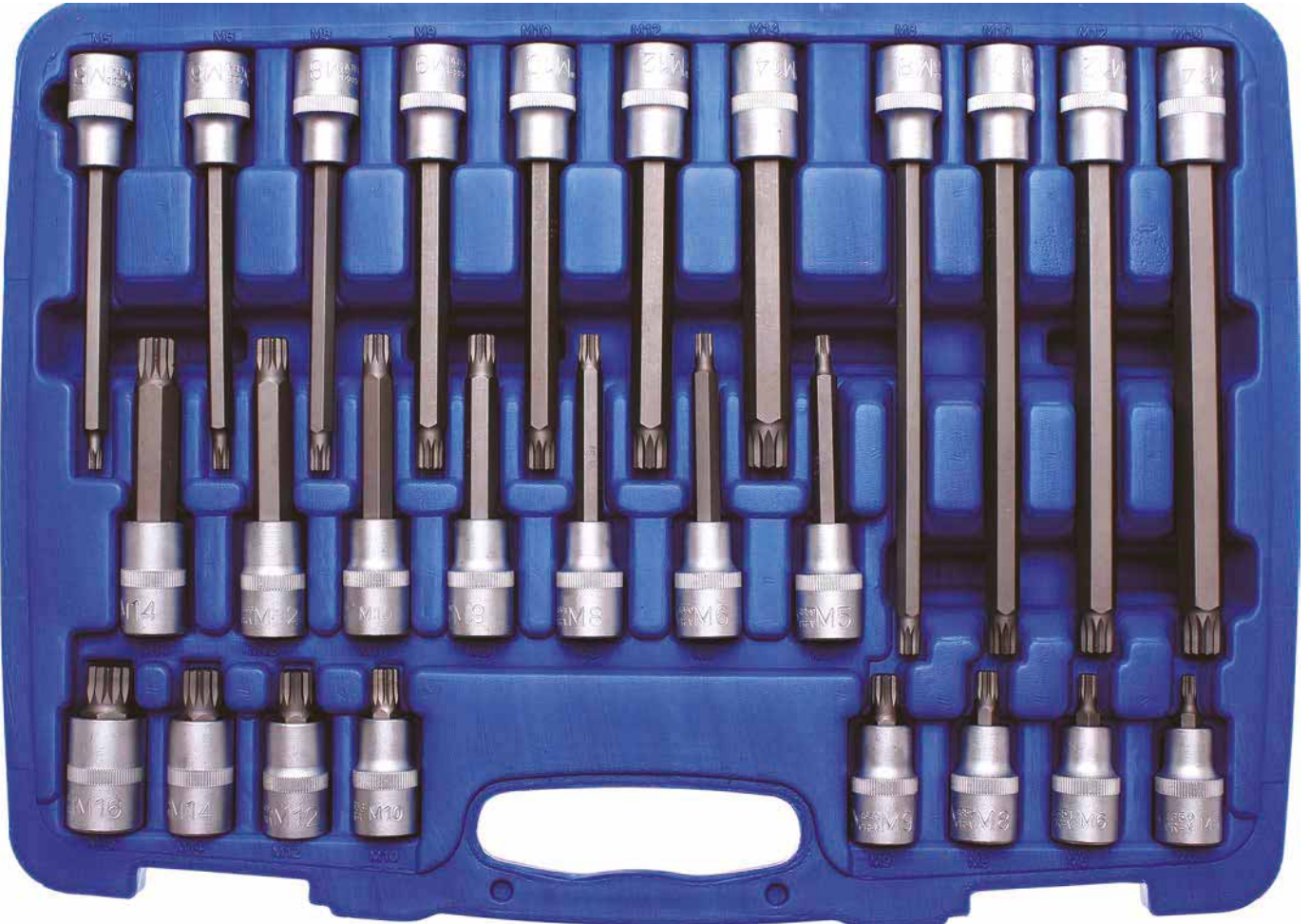

12.5mm  1/2"

Item #	Description
4350	M5 x 55 mm
4351	M6 x 55 mm
4352	M8 x 55 mm
4349	M9 x 55 mm
4353	M10 x 55 mm
4354	M12 x 55 mm
4344	M14 x 55 mm
4346	M16 x 55 mm
4359	M5 x 100 mm
4360	M6 x 100 mm
4361	M8 x 100 mm
5184-M9	M9 x 100 mm
4362	M10 x 100 mm
4363	M12 x 100 mm
4364	M14 x 100 mm

12.5mm  1/2"

Item #	Description
4330	M5 x 140 mm
4331	M6 x 140 mm
4332	M8 x 140 mm
4333	M9 x 140 mm
5184-M10	M10 x 140 mm
5184-M12	M12 x 140 mm
5184-M14	M14 x 140 mm
4334	M8 x 200 mm
4335	M10 x 200 mm
4336	M12 x 200 mm
4337	M14 x 200 mm

Impact bit Socket Set | 12.5 mm (1/2") drive | Spline (for XZN) M4 - M16 | 9 pcs. 12.5 \square 1/2

- suitable for both manual and impact wrenches
- can be fixed on impact wrench by pin and O-ring
- length: 42 mm
- Impact bit sockets, 12.5 mm (1/2") drive, spline (for XZN): M4 - M5 - M6 - M8 - M9 - M10 - M12 - M14 - M16



Item #
5487



Impact Bit Socket Set | 12.5 mm (1/2") drive | Spline (for XZN) M4 - M16 | 9 pcs. 12.5 \square 1/2

- suitable for both manual and impact wrenches
- can be fixed on impact wrench by pin and O-ring
- Impact Bit Sockets, 12.5 mm (1/2") drive, spline (for XZN): M4 - M5 - M6 - M8 - M9 - M10 - M12 - M14 - M16
- profile: Spline (for XZN)
- total length: 75 mm



Item #
5482



Impact Bit Socket Set | 12.5 mm (1/2") drive | Spline (for XZN) M12 - M18 | 8 pcs. 12.5 \square 1/2

- suitable for both manual and impact wrenches
- can be fixed on impact wrench by pin and O-ring
- Impact bit sockets in short (40 mm) and long (75 mm) design

length: 40mm

- Impact bit sockets, 12.5 mm (1/2") drive, spline (for XZN): M12 - M14 - M16 - M18

length: 75mm

- Impact bit sockets, 12.5 mm (1/2") drive, spline (for XZN): M12 - M14 - M16 - M18



Item #
5381



Impact Bit Socket Set | 12.5 mm (1/2") drive | Spline (for XZN) M14 - M18 | 6 pcs. 12.5 □ 1/2

- suitable for both manual and impact wrenches
- can be fixed on impact wrench by pin and O-ring
- Impact bit sockets in short (40 mm) and long (75 mm) design
- Application: e.g. supporting ball joints T4, brake calliper VW Touareg (rear axle), MB Atego
- single sizes (75 mm) available as BGS 5184-M14, 5482-M16, 5184-M18

length 40mm

- Impact bit socket, 12.5 mm (1/2") drive, spline (for XZN): M14 - M16 - M18

length 75mm

- Impact bit socket, 12.5 mm (1/2") drive, spline (for XZN): M14 - M16 - M18



Item #
5380



Bit Socket Set | 12.5 mm (1/2") drive | Spline (for XZN) | 5 pcs. 12.5 □ 1/2

- special set for car drive shafts
- Bit sockets: M12 x 55 mm - M 9 x 100 mm - M10 x 140 mm - M12 x 140 mm - M14 x 140 mm



Item #
8449



Drive Shaft Bit Socket Set | 800 mm | for VW | Spline (for XZN) | 3 pcs. 12.5 □ 1/2

- suitable for driveshaft screws
- suitable for driveshaft screws - no need for (several) extension bars
- suitable for VW and other brands
- drive shaft bit socket M8 x 800 mm
- drive shaft bit socket M10 x 800 mm
- drive shaft bit socket M12 x 800 mm
- surface finish: satin chrome-plated

Item #
4224



Impact Bit Socket Set | Spline (for XZN) | M4 - M16 | 8 pcs. 6.3 \square 1/4 10 \square 3/8 12.5 \square 1/2

- knurled, on socket rail
- bit sockets, 6.3 mm (1/4") drive, spline (for XZN) M4 - M5 - M6
- bit sockets, 10 mm (3/8"), spline (for XZN) M8 - M10 - M12
- bit sockets, 12.5 mm (1/2") drive, spline (for XZN) M14 - M16



Bit Socket | 6.3 mm (1/4") drive | Spline (for XZN) M4 - M12 | 6 pcs. 6.3 \square 1/4

- knurled
- on socket rail
- Bit socket, 6.3 mm (1/4") drive, spline (for XZN) M4 - M5 - M6 - M8 - M10 - M12
- surface finish: satin chrome plated



Bit Socket Set | 10 mm (3/8") / 12.5 mm (1/2") drive | Spline (for RIBE) M6 - M14 | 7 pcs. 10 \square 3/8 12.5 \square 1/2

- knurled
- on socket rail
- bit sockets, length 75 mm, 10 mm (3/8") drive, spline (for Ribe) M6, M7, M8, M10
- bit sockets, length 75 mm, 12.5 mm (1/2") drive, spline (for Ribe) M12, M13, M14
- surface finish: satin chrome plated



Impact Bit Socket Set | 12.5 mm (1/2") drive | Spline (for Ribe) M5 - M14 | 9 pcs.

- suitable for both manual and impact wrenches
- can be fixed on impact wrench by pin and O-ring
- Impact bit sockets, 12.5 mm (1/2") drive, spline (for Ribe): M5 - M6 - M7 - M8 - M9 - M10 - M12 - M13 - M14
- profile: Spline (for Ribe)
- length: 75 mm



Bit Sockets Sets

Bit Socket Set | Spline (for RIBE) | 32 pcs.

12.5mm \square 1/2"

Item #
5183

CV

CV-S2

Bit Socket Set

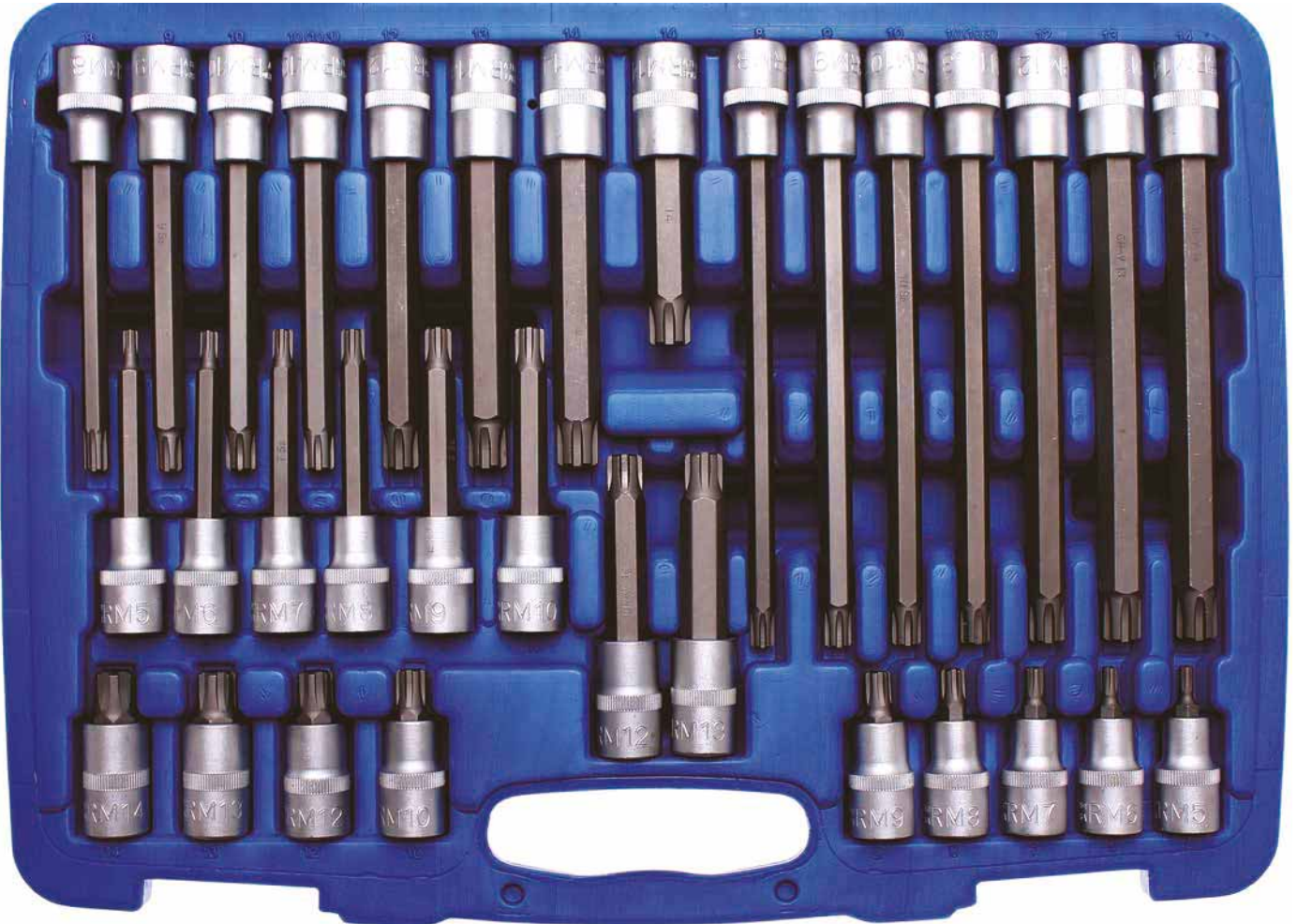

12.5mm \square 1/2"

Item #	Description
4150	M5 x 55 mm
4151	M6 x 55 mm
4152	M7 x 55 mm
4153	M8 x 55 mm
4154	M9 x 55 mm
4155	M10 x 55 mm
4156	M12 x 55 mm
4157	M13 x 55 mm
4158	M14 x 55 mm
4160	M5 x 100 mm
4161	M6 x 100 mm
4162	M7 x 100 mm
4163	M8 x 100 mm
5184-R9	M9 x 100 mm
4165	M10 x 100 mm
4166	M12 x 100 mm
4167	M13 x 100 mm
4168	M14 x 100 mm

12.5mm \square 1/2"

Item #	Description
4173	M8 x 140 mm
4174	M9 x 140 mm
5184-R10	M10 x 140 mm
4179	M10.3 x 140 mm
4176	M12 x 140 mm
4177	M13 x 140 mm
4178	M14 x 140 mm
4183	M8 x 200 mm
4184	M9 x 200 mm
4185	M10 x 200 mm
4189	M10.3 x 200 mm
4186	M12 x 200 mm
4187	M13 x 200 mm
4188	M14 x 200 mm

Bit Socket Set | T-Star (for Torx) | 32 pcs.

12.5mm \square 1/2"

Item #
5182

CV

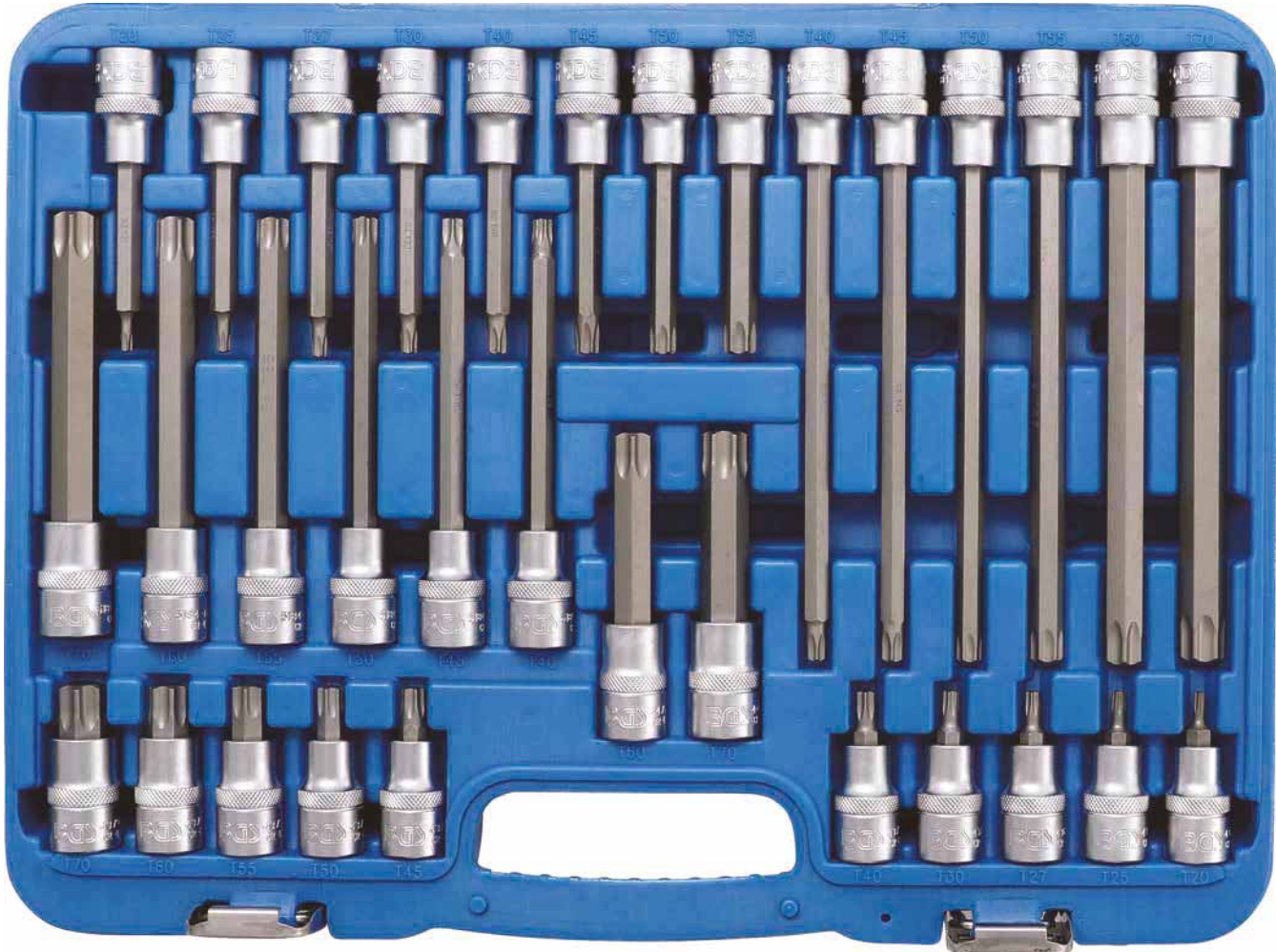

CV-S2



Bit Socket Set

12.5mm \square 1/2"  

Item #	Description
4369	T20 x 55 mm
4370	T25 x 55 mm
4367	T27 x 55 mm
4371	T30 x 55 mm
4372	T40 x 55 mm
4373	T45 x 55 mm
4374	T50 x 55 mm
4375	T55 x 55 mm
4378	T60 x 55 mm
4379	T70 x 55 mm
4469	T20 x 100 mm
4470	T25 x 100 mm
4467	T27 x 100 mm
4471	T30 x 100 mm
4472	T40 x 100 mm
4473	T45 x 100 mm
4474	T50 x 100 mm
4475	T55 x 100 mm
4476	T60 x 100 mm
4477	T70 x 100 mm

12.5mm \square 1/2"  

Item #	Description
5184-T40	T40 x 140 mm
5184-T45	T45 x 140 mm
5184-T50	T50 x 140 mm
5184-T55	T55 x 140 mm
5184-T60	T60 x 140 mm
5184-T70	T70 x 140 mm
4480	T40 x 140 mm
4481	T45 x 200 mm
4482	T50 x 200 mm
4483	T55 x 200 mm
4484	T60 x 200 mm
4485	T70 x 200 mm

Bit Socket Set | 20 mm (3/4") drive | internal Hexagon T-star (for Torx) | 9 pcs. 20 \square 3/4

- knurled
- internal hexagon, sizes:
14 - 17 - 19 - 22 mm (length 85 mm)
- T-Star (for Torx), sizes:
T60 - T70 - T80 - T90 - T100 (length 80mm)
- surface finish: chrome-plated, matt



Item #	CV
5189	

Impact Bit Socket Set | 20 mm (3/4") drive | T-Star (for Torx) T55 - T100 | 6 pcs. 20 \square 3/4

- suitable for both manual and impact wrenches
- can be fixed on impact wrench by pin and O-ring
- impact bit sockets, 20 mm (3/4") drive, T-Star (for Torx): T55 - T60 - T70 - T80 - T90 - T100
- length: 60 mm



Item #	CRO MO
5055	

Bit Socket / Socket Set | 12.5 mm (1/2") drive | E-Star / T-Star (for Torx) | 19 pcs. 12.5 \square 1/2

- knurled
- bit sockets, 12.5 mm (1/2") drive; T-Star (for Torx): T20 - T25 - T27 - T30 - T40 - T45 - T50 - T55 - T60 - T70
- sockets, 12.5 mm (1/2") drive: E-type E10 - E11 - E12 - E14 - E16 - E18 - E20 - E22 - E24
- surface finish: satin chrome plated



Item #	CV
5100	

Bit and Bit Socket Assortment | 12.5 mm (1/2") drive | T-Star (for Torx) | 27 pcs. 12.5 \square 1/2

- 5 bit sockets, 12.5 mm (1/2") drive: T45 - T50 - T55 - T60 - T70
- 7 bits T-Star (for Torx): T10 - T15 - T20 - T25 - T27 - T30 - T40
- 12 bits T-Star tamperproof (for Torx): T10 - T15 - T20 - T25 - T27 - T30 - T40 - T45 - T50 - T55 - T60 - T70
- 3 bit adaptors for drive: 6.3 mm (1/4") - 10 mm (3/8") - 12.5 mm (1/2")

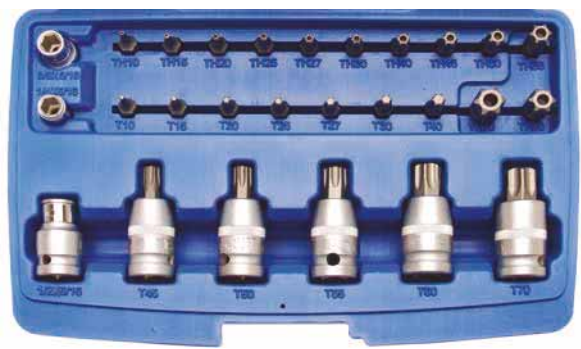

Item #	CV	CV-S2
5101		

Bit Socket Set | 12.5 mm (1/2") drive | T-Star tamperproof (for Torx) | 4 pcs.

12.5  1/2

- Large sizes
- suitable for the assembly of cylinder head bolts in Ford, BMW, Citroen, Renault, Audi, Mercedes-Benz
- Bit sockets, 12.5 mm (1/2") drive, drive T-Star tamperproof (for Torx):
 - T-70 (cylinder head bolts of many brands, oil filter tub)
 - T-80 (windshield wiper arm assembly on MAN, M series)
 - T-90 (cylinder head bolts)
 - T-100 (steering arm, MAN, F series)



Item #
5103



Impact bit Socket Set | 12.5 mm (1/2") drive | T-Star (for Torx) T20 - T70 | 9 pcs.

12.5  1/2

- suitable for both manual and impact wrenches
- can be fixed on impact wrench by pin and O-ring
- sizes: T20 - T25 - T30 - T40 - T45 - T50 - T55 - T60 - T70
- length: 85 mm
- Impact bit sockets, 12.5 mm (1/2") drive, output T-Star (for Torx): T20 - T25 - T30 - T40 - T45 - T50 - T55 - T60 - T70



Item #
5486



Impact Bit Socket Set | 12.5 mm (1/2") drive | T-Star (for Torx) T20 - T70 | 10 pcs.

12.5  1/2

- suitable for both manual and impact wrenches
- can be fixed on impact wrench by pin and O-ring
- Impact bit sockets, 12.5 mm (1/2") drive, T-Star (for Torx): T20 - T25 - T27 - T30 - T40 - T45 - T50 - T55 - T60 - T70
- profile: T-Star (for Torx)
- length: 55 mm



Item #
5097



Bit Socket Set, extra short | T-Star (for Torx) T8 - T60 | 12 pcs. 6.3 \square 1/4 10 \square 3/8 12.5 \square 1/2

- knurled
- on socket rail
- bit sockets, length 30 mm, 6.3 mm (1/4") drive, T-Star (for Torx): T8 - T10 - T15 - T20 - T25 - T27
- bit sockets, length 38 mm, 10 mm (3/8") drive, T-Star (for Torx): T30 - T40 - T45 - T50 - T55
- Bit socket, length 48 mm, 12.5 mm (1/2") drive, T-Star (for Torx): T60
- surface finish: satin chrome plated



Item #	CV 
5098	

Impact Bit Socket Set | 12.5 mm (1/2") drive | T-Star (for Torx) T20 - T70 | 9 pcs.

- suitable for both manual and impact wrenches
- can be fixed on impact wrench by pin and O-ring
- Impact bit socket, 12.5 mm (1/2") drive, T-Star (for Torx): T20 - T25 - T30 - T40 - T45 - T50 - T55 - T60 - T70
- length: 75 mm



Item #	CRO MO
5480	

Bit Socket Set | 12.5 mm (1/2") drive | T-Star (for Torx) T40 - T55 | 4 pcs. 12.5 \square 1/2

- knurled
- Bit sockets, 12.5 mm (1/2") drive, T-Star (for Torx): T40 - T45 - T50 - T55
- surface finish: satin chrome plated



Item #	CV 
8886	

Bit Socket Set | 12.5 mm (1/2") drive | T-Star tamperproof (for Torx) T40 - T55 | 4 pcs. 12.5 \square 1/2

- knurled
- Bit sockets, 12.5 mm (1/2") drive, T-Star tamperproof (for Torx): T40 - T45 - T50 - T55
- surface finish: satin chrome plated



Item #	CV 
8885	

Bit and Socket Set | 10 mm (3/8") | T-Star (for Torx) | 34 pcs.

10  3/8

- all sockets knurled and with ball retaining groove
- 11 bit sockets T-Star (for Torx): T10 - T60
- 10 bits, 5/16" drive, T-Star tamperproof (for Torx): T10 - T55
- 1 bit holder
- 12 E-type sockets: E4 - E20
- surface finish: satin chrome plated

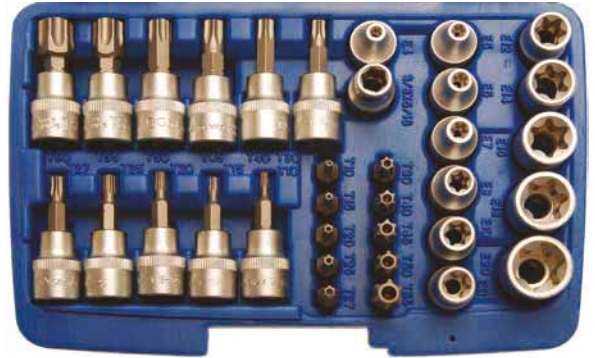

Item #
5021



Bit Socket Set | 10 mm (3/8") drive | T-Star (for Torx) T15 - T50 | 7 pcs.

10  3/8

- knurled
- on socket rail
- bit sockets, 10 mm (3/8") drive , T-Star (for Torx) T15 - T20 - T25 - T30 - T40 - T45 - T50
- surface finish: satin chrome plated



Item #
5108



Bit Socket Set | 10 mm (3/8") drive | T-Star tamperproof (for Torx) T15 - T50 | 7 pcs.

10  3/8

- knurled
- on socket rail
- sizes: T15 - T20 - T25 - T30 - T40 - T45 - T50
- surface finish: satin chrome-plated



Item #
9341



Bit Socket Set | 6.3 mm (1/4") drive | T-Star (for Torx) with Ball point T10 - T40 | 7 pcs. **6.3**  **1/4**

- knurled
- ideal for working in tight spaces
- Bit sockets, 6.3 mm (1/4") drive, T-Star (for Torx) with ball head:
 - T10 - T15 - T20 - T25 - T27 - T30 - T40
- length: 130 mm
- surface finish: satin chrome-plated

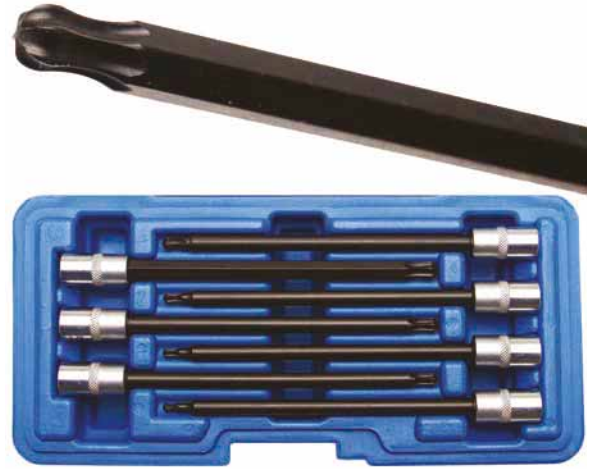

Item #
8618



Bit Socket Set | 6.3 mm (1/4") drive | T-Star (for Torx) T10 - T50 | 9 pcs. **6.3**  **1/4**

- knurled
- on socket rail
- Bit sockets, 6.3 mm (1/4") drive, T-Star (for Torx): T10 - T15 - T20 - T25 - T27 - T30 - T40 - T45 - T50
- surface finish: satin chrome plated



Item #
2164



Bit Socket Set | 6.3 mm (1/4") drive | T-Star tamperproof (for Torx) T10 - T50 | 9 pcs. **6.3**  **1/4**

- knurled
- on socket rail
- bit sockets, 6.3 mm (1/4") drive, drive T-Star tamperproof (for Torx): T10 - T15 - T20 - T25 - T27 - T30 - T40 - T45 - T50
- surface finish: satin chrome plated



Item #
2165



Universal Joint Socket Set | 6.3 mm (1/4") drive | T-Star (for Torx) T8 - T40 | 8 pcs. **6.3**  **1/4**

- sizes: T8 - T10 - T15 - T20 - T25 - T27 - T30 - T40
- on socket rail
- length: 42 mm
- surface finish: polished chrome metal



Item #
9158



Bit Socket | 6.3 mm (1/4") drive | TS-Star tamperproof (for Torx Plus) | 9 pcs. 6.3  1/4

- for pumps in Mercedes-Benz Atego, Actros and Rover anti-theft device
- on socket rail, additionally packed in plastic case
- bit sockets, 6.3 mm (1/4") drive, TS-Star tamperproof (for Torx Plus / five star) TS10 - TS15 - TS20 - TS25 - TS27 - TS30 - TS40 - TS45 - TS50



Item #	 
2355	

Bits, long | 12.5 mm (1/2") drive | T-Star (for Torx) 12.5  1/2

- profile: T-Star (for Torx)



Item #	Description
4246-T40	Bit, long 12.5 mm (1/2") drive T-Star (for Torx) T40
4246-T50	Bit, long 12.5 mm (1/2") drive T-Star (for Torx) T50



Bit, long | 12.5 mm (1/2") drive | Spline (for XZN) M10

- profile: Spline (for XZN) M10



Item #	
4246-M10	

Bits | length 100 mm | 22 mm drive | internal Hexagon

- suitable for both manual and impact wrenches
- profile: internal hexagon
- length: 100 mm
- surface finish: black burnished



Item #	Description
5246-H17	Bit length 100 mm 22 mm drive internal Hexagon 17 mm
5246-H19	Bit length 100 mm 22 mm drive internal Hexagon 19 mm
5246-H22	Bit length 100 mm 22 mm drive internal Hexagon 22 mm
5246-H24	Bit length 100 mm 22 mm drive internal Hexagon 24 mm



Bit Sockets Sets / Bits 10 mm (3/8") / Bits 22 mm

Bits | length 100 mm | 22 mm drive | T-Star (for Torx)

- suitable for both manual and impact wrenches
- profile: T-Star (for Torx)
- length: 100 mm
- surface finish: black burnished



Item #	Description
5246-T60	Bit length 100 mm 22 mm drive T-Star (for Torx) T60
5246-T70	Bit length 100 mm 22 mm drive T-Star (for Torx) T70
5246-T80	Bit length 100 mm 22 mm drive T-Star (for Torx) T80
5246-T90	Bit length 100 mm 22 mm drive T-Star (for Torx) T90
5246-T100	Bit length 100 mm 22 mm drive T-Star (for Torx) T100



Magnetic Bit-Holder | external Hexagon 6.3 mm (1/4") | 60 mm

- length: 60 mm
- surface finish: chrome-plated



Magnetic Bit-Holder, extra strong | external Hexagon 6.3 mm (1/4") | 60 mm

- extremely strong magnet that even holds screws through the bit
- length: 60 mm



Automatic Bit-Holder | internal Hexagon 6.3 mm (1/4"), 50 mm

- suitable for electric drills
- profile: internal hexagon
- drive profile size, metric: 6.3 mm
- length: 50 mm
- surface finish: satin chrome plated
- drive profile size, inch: 1/4"



Item #	Description
1730	Automatic Bit-Holder internal Hexagon 6.3 mm (1/4"), 50 mm
1731	Automatic Bit-Holder internal Hexagon 6.3 mm (1/4"), 100 mm



SDS Bit-Holder | internal Hexagon 6.3 mm (1/4") | 80 mm

- aluminum made, quick release function
- suitable for bits with 6.3 mm / 1/4" drive
- length: 80 mm



Bit Holder With Quick Coupler | 6.3 mm (1/4")

- extra slim
- suitable for 6.3 (1/4) bits, 6.3 mm (1/4") drive
- aluminium quick coupler sleeve



Magnetic Holder for Bits and Sockets "2-IN-1"

6.3 1/4

- compatible with 6.3 mm (1/4") square drive and bits with 6.3 mm (1/4") hexagonal drive
- moveable sleeve for switching between bit and socket drive



Automatic Bit-Holders | internal Hexagon 6.3 mm (1/4")

- shaft rotates in a plastic-coated metal sleeve, which allows to hold the bit holder when working



Item #	Description
1734	Automatic Bit-Holder internal Hexagon 6.3 mm (1/4"), 80 mm
1735	Automatic Bit-Holder internal Hexagon 6.3 mm (1/4"), 150 mm
1736	Automatic Bit-Holder internal Hexagon 6.3 mm (1/4"), 300 mm
1724	Automatic Bit-Holder internal Hexagon 6.3 mm (1/4"), 450 mm
1723	Automatic Bit-Holder internal Hexagon 6.3 mm (1/4"), 600 mm



Bit Sockets & Bits

Bit adaptors with retaining ball

6.3  1/4 10  3/8 12.5  1/2

- surface finish: satin chrome plated
- Retaining ball



Item #	Description
8203	Bit Adaptor with retaining Ball 6.3 mm (1/4") drive internal Hexagon 6.3 mm (1/4")
8213	Bit Adaptor with retaining Ball 6.3 mm (1/4") drive internal Hexagon 6.3 mm (1/4")
8251	Bit Adaptor with retaining Ball 6.3 mm (1/4") drive internal Hexagon 8 mm (5/16")
8225	Bit Adaptor with retaining Ball 10 mm (3/8") drive internal Hexagon 6.3 mm (1/4")
292	Bit Adaptor with retaining Ball 10 mm (3/8") drive internal Hexagon 8 mm (5/16")
291	Bit Adaptor with retaining Ball 10 mm (3/8") drive internal Hexagon 10 mm (3/8")
8201	Bit Adaptor with retaining Ball 12.5 mm (1/2") drive internal Hexagon 6.3 mm (1/4")
293	Bit Adaptor with retaining Ball 12.5 mm (1/2") drive internal Hexagon 8 mm (5/16")
290	Bit Adaptor with retaining Ball 12.5 mm (1/2") drive internal Hexagon 10 mm (3/8")
284	Bit Adaptor with retaining Ball 12.5 mm (1/2") drive internal Hexagon 14 mm



Bit Adaptor | for BGS 5246 | 20 mm (3/4") drive - internal Hexagon 22 mm

- for both manual and impact wrenches
- can be fixed on impact wrench by pin and O-ring
- surface finish: black burnished

Item #	
5246-2	



Bit Adaptor | for BGS 5246 | 25 mm (1") drive - internal Hexagon 22 mm

- for both manual and impact wrenches
- can be fixed on impact wrench by pin and O-ring
- surface finish: black burnished

Item #	
5246-1	



Bit Set for trucks | 20 mm (3/4") + 25 mm (1") | 16 pcs.

20  3/4

- for use with air tools
- 5 bits, 22 mm external hexagon drive, T-Star (for Torx): T60 - T70 - T80 - T90 - T100
- 4 bits, 22 mm external hexagon drive, internal hexagon: 17 - 19 - 22 - 24 mm
- 4 bits, 22 mm external hexagon drive, E-type: E18 - E20 - E22 - E24
- 1 bit adaptor, 20 mm (3/4") drive, internal hexagon 22 mm
- 1 bit adaptor, 25 mm (1") drive, internal hexagon 22 mm
- 1 key wrench for adjusting bits in the holder



Item #
5246



Combined Bit Set | 40 pcs.

- in metal case
- 14 internal hexagon bits, short and long type 4 - 5 - 6 - 7 - 8 - 10 - 12 mm
- 14 T-Star bits (for Torx), short and long type T20 - T25 - T30 - T40 - T45 - T50 - T55
- 10 spline bits (for XZN), short and long type M5 - M6 - M8 - M10 - M12
- 10 mm bit adaptor with 10 mm (3/8") drive
- 10 mm bit adaptor with 12.5 mm (1/2") drive



Item #
7071



Combination Bit Set | 28 pcs.

- in metal box
- 7 bits, short, internal hexagon: 4 - 5 - 6 - 7 - 8 - 10 - 12 mm
- 4 bits, long, internal hexagon: 5 - 6 - 8 - 10 mm
- 4 bits, short, spline (for XZN): M5 - M6 - M8 - M10
- 4 bits, long, spline (for XZN): M6 - M8 - M10 - M12
- 7 special bits T-Star (for Torx): T20 - T25 - T30 - T40 - T45 - T50 - T55
- 2 adaptors 10 mm (3/8") and 12.5 mm (1/2") drive, with ball, for bits 10 mm



Item #
5028



Bit and Socket Set | E-Type / T-Star (for Torx) | 30 pcs.

- E-type sockets, 6.3 mm (1/4") drive: E4 - E5 - E6 - E7 - E8
- E-type sockets, 10 mm (3/8") drive: E10 - E11 - E12 - E14
- E-type sockets, 12.5 mm (1/2") drive: E16 - E18 - E20 - E22 - E24
- bits, length 30 mm, 10 mm (3/8") drive, T-Star (for Torx): T20 - T25 - T30 - T40 - T45 - T50 - T55
- bits, length 75 mm, 10 mm (3/8") drive, T-Star (for Torx): T20 - T25 - T30 - T40 - T45 - T50 - T55
- 12.5 mm (1/2") bit adaptor for 10 mm (3/8") bits
- 10 mm (3/8") bit adaptor for 10 mm (3/8") bits
- surface finish: satin chrome-plated



Item #	CV	CV-S2
5025		

Bit and Socket Set | E-Type / T-Star (for Torx) | 17 pcs.

- tamperproof bits
- E-type sockets, 6.3 mm (1/4") drive: E6 - E7 - E8
- E-type sockets, 10 mm (3/8") drive: E10 - E12 - E14 - E16
- 9 bits, 8 mm (5/16") drive, T-Star tamperproof (for Torx): T10 - T15 - T20 - T25 - T30 - T40 - T45 - T50 - T55
- bit adaptor 10 mm (3/8") drive, 8 mm (5/16") hexagon

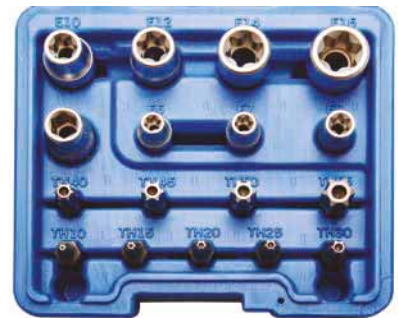

Item #	CV	CV-S2
5023		

Bit Set | 10 mm (3/8") hex drive | Spline (for Ribe) | 22 pcs.

- bits, each size in 30 and 100 mm length, 10 mm (3/8") external hexagon drive, spline (for Ribe): M5 - M6 - M7 - M8 - M9 - M10 - M11 - M12 - M13
- bits, 100 mm, 10 mm (3/8") external hexagon drive, spline (for Ribe): M14 and M10.3
- bit adaptor 12.5 mm (1/2") and 10 mm (3/8") drive



Item #	CV	CV-S2
5013		

Bit Set | 10 mm (3/8") hex drive | T-Star tamperproof (for Torx) | 26 pcs.

- bits, length 30 mm, 10 mm (3/8") external hexagon drive, T-Star tamperproof (for Torx): T10 - T15 - T20 - T25 - T27 - T30 - T40 - T45 - T50 - T55 - T60 - T70
- 1 adaptor 10 mm (3/8") drive
- 1 adaptor 12.5 mm (1/2") drive



Item #	CV	CV-S2
5022		

Screwdriver Bit Set | 10 mm (3/8") hex drive | Spline (for XZN) | 6 pcs.

- suitable for spline screws (for XZN)
- 5 bits, length: 30 mm, for spline screw heads M5 - M6 - M8 - M10 - M12
- 1 bit adaptor with retaining ball | 12.5 mm (1/2") drive - 10 mm (3/8") internal hexagon



Screwdriver Bit Set | 10 mm (3/8") hex drive | T-Star (for Torx) | 7 pcs.

- for T-Star screws (for Torx)
- 6 bits length: 30 mm, for T-Star screw heads (for Torx) T25 - T30 - T40 - T45 - T50 - T55
- 1 bit adaptor with retaining ball | 12.5 mm (1/2") drive - 10 mm (3/8") internal hexagon



Screwdriver Bit Set | 10 mm (3/8") hex drive | internal Hexagon | 7 pcs.

- for internal hexagon screws
- 6 bits, length: 30 mm, for internal hexagon screw heads: 4 - 5 - 6 - 8 - 10 - 12 mm
- 1 bit adaptor with retaining ball | 12.5 mm (1/2") drive - 10 mm (3/8") internal hexagon



Bit Sockets & Bits

Bit and Bit Holder Set | Sales Display | 6,3 mm (1/4") drive | 340 pcs.

- in transparent acryl reinforced plastic box with sliding cover lid
- for hand use or electric screw driver
- including bits and bit-holders with external hexagon 6.3 mm (1/4")
- 10 pcs. bit, cross slot PH1
- 20 pcs. bit, cross slot PH2
- 10 pcs. bit, cross slot PH3
- 10 pcs. bit, cross slot PZ1
- 20 pcs. bit, cross slot PZ2
- 10 pcs. bit, cross slot PZ3
- 10 pcs. bit, slot SL 4.5 mm
- 20 pcs. bit, slot SL 5.5 mm
- 10 pcs. bit, slot SL 7 mm
- 10 pcs. bit, slot SL 8 mm
- 10 pcs. bit, internal hexagon 3 mm
- 10 pcs. bit, internal hexagon 4 mm
- 10 pcs. bit, internal hexagon 5 mm
- 10 pcs. bit, internal hexagon 6 mm
- 10 pcs. bit, internal hexagon 8 mm
- 10 pcs. bit, T-Star (for Torx) T10
- 10 pcs. bit, T-Star (for Torx) T15
- 10 pcs. bit, T-Star (for Torx) T20
- 10 pcs. bit, T-Star (for Torx) T25
- 10 pcs. bit, T-Star (for Torx) T27
- 10 pcs. bit, T-Star (for Torx) T30
- 10 pcs. bit, T-Star (for Torx) T40
- 10 pcs.bit, T-Star tamperproof (for Torx) T10
- 10 pcs.bit, T-Star tamperproof (for Torx) T15
- 10 pcs.bit, T-Star tamperproof (for Torx) T20
- 10 pcs.bit, T-Star tamperproof (for Torx) T25
- 10 pcs.bit, T-Star tamperproof (for Torx) T27
- 10 pcs.bit, T-Star tamperproof (for Torx) T30
- 10 pcs.bit, T-Star tamperproof (for Torx) T40
- 10 pcs. automatic bit holder, external hexagon 6.3 mm (1/4"), 60 mm
- 10 pcs. magnetic bit holder, external hexagon 6.3 mm (1/4"), 60 mm
- dimensions: 39 x 33 x 45 mm



Item #
9328



Universal Bit Set | 122 pcs.

- 200 mm spinner handle with anti slip function
- 121 bits and accessories for all applications:
- Bit holder, hook driver bit, 50 mm socket adaptor
- 1/4" x 1/4" - bit adaptor and 1/4" x 1/4" - socket adaptor
- 20 bit sockets 38 mm:
 - 4 - 5 - 6 - 7 - 8 - 9 - 10 - 11 - 12 - 13 mm
 - 5/32" - 3/16" - 7/32" - 1/4" - 9/32" - 11/32" - 5/16" - 3/8" - 7/16" - 1/2"
- 67 bits 25 mm:
 - TS-Star (for Torx Plus): 10 - 15 - 20 - 25 - 27 - 30 - 40 - 45 - 50
 - slot SL: 3 - 4 - 4.5 - 5 - 5.5 - 6 - 6.5 - 7 - 8 mm
 - cross slot: PH00 - PH0 - PH1 - PH2 - PH3
 - cross slot: PZ00 - PZ0 - PZ1 - PZ2 - PZ3
 - internal hexagon: 1.5 - 2 - 2.5 - 3 - 4 - 5 - 5.5 - 6 - 8 mm
 - internal hexagon: 1/16" - 5/64" - 3/32" - 7/64" - 1/8" - 9/64" - 5/32" - 3/16" - 7/32" - 1/4"
 - T-Star (for Torx) T5 - T6 - T7 - T8 - T9 - T10 - T15 - T20 - T25 - T27 - T30 - T40 - T45
 - Spline (for XZN) M5 - M6 - M8
 - internal square: S0 - S1 - S2 - S3
 - internal hexagon tamperproof 2 - 2.5 - 3 - 4 - 5 - 6 mm
 - T-Star 6 - 8 - 10
 - Spanner: 4 - 6 - 8 - 10
 - 3-wing 1 - 2 - 3 - 4
 - T-Star (for Torx) tamperproof T8 - T10 - T15 - T20 - T25 - T27 - T30 - T35 - T40
 - Clutch C1 - C2 - C3



Bit Sockets & Bits

Item #	 
20100	

Bit Set for Security Screws, long | 51 pcs.

- countersunk tips guarantee excellent use, even in narrow or very tight spaces, especially in electronic engineering
- length: each 75 mm
- 1/4" hexagon drive
- 1 magnetic bit holder
- 1 bit holder, 6.3 mm (1/4")
- T-Star tamperproof (for Torx) T8 - T10 - T15 - T20 - T25 - T27 - T30 - T35 - T40
- T-Star (for Torx) T10- T15 - T20 - T25 - T30
- int. hex. tamperproof: 2 - 2.5 - 3 - 4 - 5 - 6 mm
- internal hexagon, 4 - 5 - 6 mm
- slot sl 4 - 5 - 6 mm
- cross slot PH PH1, PH2
- cross slot PZ PZ1, PZ2
- Spline (for XZN) M5 - M6 - M8
- Spanner bits 4 - 6 - 8 - 10 mm
- two wing bits: No. 1 - 2 - 3
- tri-wing bits: No. 1 - 2 - 3 - 4
- four wing bits: No. 6 - 8 - 10
- internal square S1 - S2



Item #	
757	

Security Bit Set | 6.3 mm (1/4") drive | 100 pcs.

- 1 magnetic bit holder, 60 mm
- 1 hook driver bit
- 1 double external adaptor 6.3 mm (1/4") square x 6.3 mm (1/4") hexagon
- 1 bit holder 6.3 mm (1/4") drive for 6.3 mm (1/4") bits
- 1 bit adaptor for electric drills, 6,3 mm (1/4") hexagon shaft
- 95 bits slot, cross slot (PH), T-Star (for Torx), cross slot (PZ), internal hexagon, Spline (for XZN), square, for spanner®, for torque®, for Tri Wing®, Clutch



Item #	
765	

Color Bit Set | 71 pcs.

- intelligent colour guide, one colour for each profile
- 60 bits, length: 25 mm
 - plain slot: 3x 4 mm, 3x 6 mm
 - Cross slot PH: 3x PH1, 6x PH2, 3x PH3
 - Cross slot PZ: 3x PZ1, 6x PZ2, 3x PZ3
 - internal hexagon: 3x 4 mm, 3x 5 mm, 3x 6 mm
 - T-Star (for Torx): 3x T10, 3x T15, 3x T20, 3x T25, 3x T27, 3x T30, 3x T40
- 9 bits, length: 75 mm
 - plain slot: 4 mm, Slot 6 mm
 - Cross slot PH: PH1, PH2, PH3
 - Cross slot PZ: PZ1, PZ2
 - T-Star (for Torx): T20, T25
- 1 bit holder with quick chuck
- 1 bit holder with magnet



Item #		
4815		

Color Bit Set | 32 pcs.

- intelligent colour guide, one colour for each profile
- 30 bits, length 25 mm
 - plain slot SL 3-4-5-6 mm
 - cross slot PH1 - PH2 - PH2 - PH3
 - cross slot PZ1 - PZ2 - PZ2 - PZ3
 - internal hexagon 3 - 4 - 5 - 6 mm
 - T-Star (for Torx) T10 - T15 - T20 - T25 - T27 - T30 - T40
 - T-Star tamperproof (for Torx): T10 - T15 - T20 - T25 - T27 - T30 - T40
- 1 bit adaptor
- 1 quick chuck bit holder



Item #			
4816			

Bit Set | TS Star (for Torx Plus) | 23 pcs.

- suitable for new T-Star (for Torx) PLUS screws
- 6.3 mm (1/4") bit adaptor for electric drills
- 6.3 mm (1/4") bit adaptor
- 10 mm (3/8") bit adaptor
- T-Star PLUS bits with hole (TPH): TP10H - TP15H - TP20H - TP25H - TP30H - TP40H - TP45H - TP50H - TP55H - TP60H
- T-Star PLUS bits without hole (TPS): TPS10 - TPS15 - TPS20 - TPS25 - TPS30 - TPS40 - TPS45 - TPS50 - TPS55 - TPS60

Item #
4993



Bit Set | long | 6.3 mm (1/4") drive | various Types | 32 pcs.

- for security screws
- 6.3 mm (1/4") drive
- length 75 mm
- suitable for electric drills
- 9 bits T-star tamperproof (for Torx) T8 - T10 - T15 - T20 - T25 - T27 - T30 - T35 - T40
- 6 bits internal hexagon-tamperproof 2 - 2.5 - 3 - 4 - 5 - 6 mm
- 3 bits offset four wings 6 - 8 - 10 mm
- 4 bits fork spanner 4 - 6 - 8 - 10 mm
- 4 bits tri-wing 1 - 2 - 3 - 4
- 3 bits cross slot PZ1 - PZ2 - PZ3
- 2 bits cross slot PH1 - PH2
- 1 bit slot SL 6 mm

Item #
762



Bit Set | 6.3 mm (1/4") drive | T-Star (for Torx) | 11 pcs.

- bits for T-Star (for Torx) screws, 6.3 mm (1/4") external hexagon drive, T7 - T8 - T9 - T10 - T15 - T20 - T25 - T27 - T30 - T40 - T45

Item #
784



Bit Set | 6,3 mm (1/4") / 10 mm (3/8") drive | T-Star tamperproof (for Torx) | 11 pcs.

- 6 bits, 6.3 mm (1/4") drive, T-Star (for Torx) T10 - T15 - T20 - T25 - T27 - T30
- 3 bits, 5/16" drive, T-Star (for Torx) T40 - T45 - T50
- 1 bit adaptor 6.3 mm (1/4") x 6.3 mm (1/4") internal square
- 1 bit adaptor 8 mm (5/16") x 10 mm (3/8") internal square

Item #
786



Color Bit and Socket Set | 28 pcs.

6.3 mm 1/4"

- hexagon sockets, 6.3 mm (1/4") drive, knurled: 6 - 8 - 10 - 11 - 12 - 13 mm
- bit adaptor 6.3 mm (1/4") drive - 6.3 mm (1/4") drive | 25,5 mm
- automatic bit holder, 6.3 mm (1/4") drive - 6.3 mm (1/4") drive, 60 mm
- 20 colour-coded bits, 6.3 mm (1/4") drive:
 - Slot: 4-6 mm
 - Cross slot PH: PH1 - PH2 - PH3
 - Cross slot PZ: PZ1 - PZ2 - PZ3
 - internal hexagon Wrenches: 4 - 5 mm
 - T-Star (for Torx): T10 - T15 - T20 - T25 - T30
 - T-Star tamperproof (for Torx): T10 - T15 - T20 - T25 - T30
- surface finish: satin chrome-plated



Item #
9384



Special Bit Ratchet | extra thin | 6.3 mm (1/4") drive | incl. 4 special bits

6.3 mm 1/4"

- for use under limited space conditions
- reversible ratchet
- 2 slotted bits: SL 3 mm - 5 mm
- 2 cross slot bits: PH1 - PH2
- length: 100 mm
- head thickness: 5 mm
- surface finish: chrome-plated



Item #
115



Stubby Ratchet Set | 6.3 mm (1/4") / 10 mm (3/8") / 12.5 mm (1/2") | 3 pcs.

- extra small size, for narrow and tight spaces
- fine 72 tooth
- with quick release button
- in metal case
- 1 Stubby Ratchet, external square drive 10 mm (3/8"), length 140 mm
- 1 Stubby Ratchet, external square drive 12.5 mm (1/2"), length 170 mm
- 1 Stubby Ratchet, external square 6.3 mm (1/4"), length 110 mm



Item #	
215	

Stubby Ratchets | Finely toothed

- extra small size
- for use under limited space conditions
- fine 72 tooth
- with quick release button
- anti-slip ergonomically formed 2-component handle



Item #	Description
212	Stubby Ratchet external square 6.3 mm (1/4")
209	Stubby Ratchet external square 10 mm (3/8")
210	Stubby Ratchet external square 12.5 mm (1/2")



Reversible Ratchets

- with quick release
- anti-slip ergonomically formed 2-component handle
- 24 tooth



Item #	Description
227	Reversible Ratchet 6.3 mm (1/4")
2308	Reversible Ratchet 10 mm (3/8")
2304	Reversible Ratchet 12.5 mm (1/2")



Reversible Ratchets

- ABS-handle
- with quick release button
- 24 tooth



Item #	Description
2207	Reversible Ratchet 6.3 mm (1/4")
2205	Reversible Ratchet 10 mm (3/8")
2206	Reversible Ratchet 12.5 mm (1/2")



Reversible Ratchet | finely toothed

- fine toothed (72 tooth)
- with quick release
- anti-slip ergonomically formed 2-component handle



Item #	Description
315	Reversible Ratchet 6.3 mm (1/4")
316	Reversible Ratchet 10 mm (3/8")
317	Reversible Ratchet 12.5 mm (1/2")



Reversible Ratchets | finely toothed

- cranked design
- fine 72 tooth
- with socket quick release
- anti-slip ergonomically formed 2-component handle



Item #	Description
318	Reversible Ratchet fine gearing 6.3 mm (1/4")
319	Reversible Ratchet fine gearing 10 mm (3/8")
320	Reversible Ratchet fine gearing 12.5 mm (1/2")



Reversible Ratchet | plastic body

- ergonomically shaped
- with quick release
- fine toothed mechanism (72 teeth)
- polypropylene coated Cr-V steel with 2-component handle
- DIN-limits for max. torque are distinctively exceeded by this tool



Item #	Description
302	Reversible Ratchet, plastic body 6.3 mm (1/4")
303	Reversible Ratchet, plastic body 10 mm (3/8")
304	Reversible Ratchet, plastic body 12.5 mm (1/2")



Reversible Ratchets | extra long

10 3/8

- cranked version
- anti-slip ergonomically formed
- with 72 teeth
- with quick release
- anti-slip ergonomically formed 2-component handle



Item #	Description
9090	Reversible Ratchet extra long 10 mm (3/8") 254 mm
324	Reversible Ratchet extra long 12.5 mm (1/2") 380 mm



Reversible Ratchets for Single-Handed-Use

- left and right switch by rotary switch on the handle: the second hand remains free!
- extra-flat ratchet head design, can also be used in hard-to-reach areas
- fine 60 tooth
- small pivoting angle
- high duty finish



Item #	Description
355	Reversible Ratchet for Single-Handed Use with Rotary Switch 6.3 mm (1/4")
356	Reversible Ratchet for Single-Handed Use with Rotary Switch 10 mm (3/8")
357	Reversible Ratchet for Single-Handed Use with Rotary Switch 12.5 mm (1/2")



Ratchets

Reversible Ratchet | 20 mm (3/4")

20 3/4

- with knurled handle
- length: 500 mm



Reversible Ratchet | 20 mm (3/4")

20 3/4

- suitable for BGS 1207, 1223, 1107, 1206
- max torque: 1560 Nm
- length: 500 mm



Reversible Ratchet | 25 mm (1") | 550 mm

25 1

- length: 550 mm
- teeth: 24



Item #	Description
300	Reversible Ratchet 25 mm (1") 550 mm
300-1	Replacement Head for BGS 300 550 mm



Flexible Ratchet with T-Handle | external square 6.3 mm (1/4")

6.3  1/4

- profile: external square
- drive profile size, metric: 6.3 mm
- length: 450 mm
- surface finish: polished chrome metal
- drive profile size, inch: 1/4"



Item #
2126



Free Wheel Ratchets

- with square head that can be pushed through but never be lost
- minimal self-centring effect
- with a slim head
- non-insulated handle



Item #	Description
2274	Free Wheel Ratchet external square 6.3 mm (1/4")
2272	Free Wheel Ratchet external square 12.5 mm (1/2")

Reversible Ratchet with swivel Head | 10 mm (3/8")

10  3/8

- for screwed connections that are hard to reach
- spinning head (360°) is adjustable in every position
- if not adjusted, good for quick screwing



Item #
321



Reversible Ratchet, with exchangeable handle | 12.5 mm (1/2") | 220 - 360 - 565 mm

12.5  1/2

- the ratchet head can be used with 3 handles with different length, resulting in a ratchet with possible total length of: 220 mm, 360 mm, 565 mm
- fine toothed ratchet head, 48 teeth
- high torque up to 575 Nm



Item #
2315



Reversible Ratchets, extendable

- adjustable and fixable length
- ratchet head adjustable in 10 positions
- fine 72 tooth
- quick release
- chrome vanadium, satin chrome plated



Item #	Description
25105	Reversible Ratchet, extendable, bendable 6.3 mm (1/4") 175 - 225 mm
25106	Reversible Ratchet, extendable, bendable 10 mm (3/8") 240 - 340 mm
25107	Reversible Ratchet, extendable, bendable 12.5 mm (1/2") 345 - 495 mm



Reversible Ratchets, extendable

- adjustable and fixable
- satin chrome plated
- fine 72 tooth
- quick release



Item #	Description
25103	Reversible Ratchet, extendable 6.3 mm (1/4") 150 - 200 Nm
25104	Reversible Ratchet, extendable 12.5 mm (1/2") 305 - 445 Nm
25108	Reversible Ratchet, extendable 12.5 mm (1/2") 450 - 610 mm



Reversible Ratchet with Spinner Handle

- fine toothed
- suitable for left and right operation
- by turning the handle a rotary motion of the drive is achieved, facilitates work in narrow spaces
- conventional ratcheting is also possible
- turning direction indicated on ratchet head
- chrome plated, with ergonomic handle design



Item #	Description
105	Reversible Ratchet with Spinner Handle 6.3 mm (1/4")
106	Reversible Ratchet with Spinner Handle 10 mm (3/8")
107	Reversible Ratchet with Spinner Handle 12.5 mm (1/2")



Reversible ratchets with Ball Head

- 180° adjustable drive head can be adjusted for almost all work positions
- chrome plated
- fine 72 tooth
- quick release



Item #	Description
112	Reversible Ratchet with Ballpoint finely toothed 6.3 mm (1/4")
113	Reversible Ratchet with Ballpoint finely toothed 10 mm (3/8")
114	Reversible Ratchet with Ballpoint finely toothed 12.5 mm (1/2")

Flexible Ratchet, lockable

- satin chrome plated
- securely adjustable in 5 positions
- 45 tooth
- with quick release
- anti-slip ergonomically shaped 2-component handle



Item #	Description
285	Flexible Ratchet, lockable external square 6.3 mm (1/4")
286	Flexible Ratchet, lockable external square 10 mm (3/8")
287	Flexible Ratchet, lockable external square 12.5 mm (1/2")

Push-through Ratchet | internal square 6.3 mm (1/4")

6.3 1/4

- square included (replacement square available under BGS 9161)
- profile: internal square
- drive profile size, metric: 6.3 mm
- drive profile size, inch: 1/4"
- surface finish: satin chrome-plated
- no. of teeth in ratchet head: 30
- handle type: 2-component handle



Item #	Description
9160	Push-through Ratchet internal square 6.3 mm (1/4")
9161	Square Head external square 6.3 mm (1/4") for BGS 9160

Push-through Ratchet | internal square 12.5 mm (1/2")

12.5  1/2

- without square head
- anti-slip ergonomically formed 2-component handle
- length: 270 mm
- surface finish: satin chrome plated



Item #	Description
312	Push-through Ratchet internal square 12.5 mm (1/2")
313	Square Drive external square 12.5 mm (1/2") for BGS 312



Ratchet Adaptor | fine gearing | external square 12.5 mm (1/2")

12.5  1/2

- fine toothed (72 tooth)
- reversible clockwise/anticlockwise
- easy to use in combination with handle BGS 265 or 12.5 (1/2") sliding t-bar
- max. diameter 40 mm
- length: 60 mm



Item #
2301



Scaffolding Ratchets

- reversible
- forged shaft



Item #	Description
308	Scaffolding Ratchet 17 x 19 mm
309	Scaffolding Ratchet 17 x 21 mm
310	Scaffolding Ratchet 19 x 22 mm
311	Scaffolding Ratchet 19 x 24 mm
305	Scaffolding Ratchet 24 x 30 mm
306	Scaffolding Ratchet 27 x 32 mm
307	Scaffolding Ratchet 36 x 41 mm



Bit Ratchets

- for adapter-free operation of bits



Item #	Description
354	Bit Ratchet internal Hexagon 6.3 mm (1/4")
353	Bit Ratchet internal Hexagon 10 mm (3/8")



Bit Ratchet | internal Hexagon 8 mm (5/16")

- can also be used as replacement for door hinge tool set BGS 3539
- profile: internal hexagon
- drive profile size, metric: 8 mm
- length: 240 mm
- drive profile size, inch: 5/16"



Item #
3559

Repair Kit for Ratchet Head

- all wearing components for the head of a ratchet in one set



Item #	Description
179	Repair Kit for Ratchet Head on BGS 227
180	Repair Kit for Ratchet Head on BGS 2304
176	Ratchet Head Repair Kit for BGS 302, 315, 318, 25105
177	Ratchet Head Repair Kit for BGS 303, 316, 319, 25106
178	Ratchet Head Repair Kit for BGSs 317, 320, 324, 25104, 25107
182	Repair Kit for Ratchet Head on BGS 302
183	Repair Kit for Ratchet Head on BGS 303
184	Repair Kit for Ratchet Head on BGS 304
321-REPAIR	Ratchet Repair Kit for BGS 321
322-REPAIR	Ratchet Repair Kit for BGS 322
323-REPAIR	Ratchet Repair Kit for BGS 323
355-REPAIR	Ratchet Repair Kit for BGS 355
356-REPAIR	Ratchet Repair Kit for BGS 356
357-REPAIR	Ratchet Repair Kit for BGS 357
211-REPAIR	Ratchet Repair Kit for BGS 211
2315-REPAIR	Ratchet Repair Kit for BGS 2315, 1204
232-REPAIR	Ratchet Repair Kit for BGS 232
300-REPAIR	Repair Kit for Ratchet for BGS 300



Flexible extension bar | 6.3 mm (1/4")



Item #	Description
2320	Flexible Extension bar 6.3 mm (1/4") 150 mm
2321	Flexible Extension Bar 6.3 mm (1/4") 450 mm



Special Extension Bar | 6.3 mm (1/4")

6.3  1/4

- especially suitable for difficult to access screws
- useful for e.g. screws on front engine covers on transverse-mounted engines and other applications
- chain driven
- 265 mm extension
- max. torque 55 Nm
- length: 300 mm
- width: 33 mm



Item #
8616

Extension Bar Set | 6.3 mm (1/4") | 300 / 380 / 450 mm

6.3  1/4

- profile: external square
- drive profile size, metric: 6.3 mm
- material: carbon steel
- surface finish: polished chrome metal
- drive profile size, inch: 1/4"



Item #
2235



"Wobble" Extension Bar Set | 6.3 mm (1/4") | 50 / 150 / 250 mm | 3 pcs.

6.3  1/4

- knurled
- 3 extension bars, 6.3 mm (1/4") drive: 50 - 150 - 250 mm
- surface finish: satin chrome-plated



Item #
2233



"Wobble" Extension Bar Set | 6.3 mm (1/4") / 10 mm (3/8") / 12.5 mm (1/2") | 9 pcs.

6.3  1/4 | 10  3/8 | 12.5  1/2

- 3 "wobble" extension bars, 6.3 mm (1/4") drive: 50 - 100 - 250 mm
- 3 "wobble" extension bars, 10 mm (3/8") drive: 75 - 150 - 250 mm
- 3 "wobble" extension bars, 12.5 mm (1/2") drive: 50 - 125 - 250 mm



Item #
2253



Extension Bar Set | 10 mm (3/8") | 375 / 450 / 600 mm | 3 pcs.

10  3/8

- profile: external square
- drive profile size, metric: 10 mm
- material: carbon steel
- surface finish: polished chrome metal
- drive profile size, inch: 3/8"



Item #
2236



"Wobble" Extension Bar Set | 10 mm (3/8") | 75 / 150 / 250 mm | 3 pcs.

10  3/8

- knurled
- surface finish: satin chrome plated

Item #
2239



Special Extension Bar | 10 mm (3/8")

10  3/8

- especially suitable for difficult to access screws
- useful for e.g. screws on front engine covers on transverse-mounted engines and other applications
- chain driven
- 265 mm extension
- max. torque 150 Nm
- length: 300 mm
- width: 33 mm

Item #
8617



Impact Extensions

- for both manual and impact wrenches
- can be fixed on impact wrench by pin and O-ring
- length: 75 mm
- surface finish: black burnished



Item #	Description
192	Impact Extension Bar 12.5 mm (1/2") 75 mm
193	Impact Extension Bar 12.5 mm (1/2") 125 mm
194	Impact Extension Bar 12.5 mm (1/2") 250 mm



Impact Extension Bar with Ball Bearing Handle | 12.5 mm (1/2") | 200 mm

12.5  1/2

- for both manual and impact wrenches
- can be fixed on impact wrench by pin and O-ring
- also an additional handle, for easy holding heavy machines with two hands
- only the interior extension bar spins the handle stays firmly in its place
- profile: external square
- drive profile size, metric: 12.5 mm
- length: 200 mm
- drive profile size, inch: 1/2"

Item #
191



Extension Bar Set | 12.5 mm (1/2") | 450 / 600 / 750 mm | 3 pcs.

- profile: external square
- drive profile size, metric: 12.5 mm
- material: carbon steel
- surface finish: polished chrome metal
- drive profile size, inch: 1/2"

Item #
2237



"Wobble" Extension Bar Set | 12.5 mm (1/2") | 50 / 125 / 250 mm | 3 pcs.

12.5 1/2

- knurled
- 3 extension bars, 12.5 mm (1/2") drive: 50 - 125 - 250 mm
- surface finish: satin chrome-plated

Item #
2240



Flexible Extension Bar | 12.5 mm (1/2") | 190 mm

12.5 1/2

- profile: external square
- drive profile size, metric: 12.5 mm
- length: 190 mm
- surface finish: chrome-plated
- drive profile size, inch: 1/2"

Item #
2323



Flexible Extension Bar | external/internal square 12.5 mm (1/2") | 300 mm

12.5 1/2

- allows screwing also in hard to reach areas
- 360° twistable
- only for putting screws in place or hand-tight screw connections
- length: 300 mm

Item #
8483



LED Extension Bar | 12.5 mm (1/2") | 63 mm

12.5 1/2

- 12.5 mm (1/2") extension bar with built in LED light
- illuminates the working area through the socket
- batteries and spare batteries included
- length: 63 mm

Item #
3125



Extension Bar Set with magnetic holders | 6.3 mm (1/4") / 10 mm (3/8") / 12.5 mm (1/2") | 3 pcs.

- holds screws and nuts in the socket after loosening in socket
- extension bar 6.3 mm (1/4") drive
- extension bar 10 mm (3/8") drive
- extension bar 12.5 mm (1/2") drive



Item #	CV
198	

Impact Extension Bar Set | external/internal square 20 mm (3/4") | 3 pcs. 20 3/4

- for both manual and impact wrenches
- can be fixed on impact wrench by pin and O-ring
- Impact extension: 100 mm
- Impact extension: 150 mm
- Impact extension: 250 mm



Item #	CRO MO
8840	

Electric Drill Wobble Adaptor Set | 6.3 mm (1/4") drive | 3 pcs. 6.3 1/4

- adaptor, length 65 mm drive outer square with retaining ball 6.3 mm (1/4")
- adaptor, length 65 mm drive outer square with retaining ball 10 mm (3/8")
- adaptor, length 72 mm drive outer square with retaining ball 12.5 mm (1/2")



Item #	CV	
9162		

Socket Adaptor | 65 mm | SDS external square 12.5 mm (1/2")

- for adaptation of e.g. sockets on SDS-machines
- length: 65 mm



Item #	
8214-1	

Adaptor Set | SDS - external square 6.3 mm (1/4"), 10 mm (3/8"), 12.5 mm (1/2") | 3 pcs.

- the adaptor kit allows use of square socket wrench inserts with SDS Drills



Item #
8214



Bit Ratchet Adaptors | 30 mm

Item #	Description
2229-1	Bit Ratchet Adaptor ext. Hexagon 8 mm (5/16") - ext. square 10 mm (3/8") 30 mm
8202	Bit Ratchet Adaptor ext. Hexagon 6.3 mm (1/4") - ext. square 6.3 mm (1/4") 30 mm



Adaptor Set | 6 pcs.

- 1 adaptor 6.3 mm (1/4") drive - external square 10 mm (3/8"), max. capacity 60 Nm
- 1 adaptor 10 mm (3/8") drive - external square 6.3 mm (1/4"), max. capacity 60 Nm
- 1 adaptor 10 mm (3/8") drive - external square 12.5 mm (1/2"), max. capacity 200 Nm
- 1 adaptor 12.5 mm (1/2") drive - external square 10 mm (3/8"), max. capacity 200 Nm
- 1 adaptor 12.5 mm (1/2") drive - external square 20 mm (3/4"), max. capacity 500 Nm
- 1 adaptor 20 mm (3/4") drive- external square 12.5 mm (1/2"), max. capacity 500 Nm
- surface finish: satin chrome plated



Item #
199



Impact Adaptor Set | 6 pcs.

- suitable for both manual and impact wrenches
- can be fixed on impact wrench by pin and O-ring
- 1 adaptor 6.3 mm (1/4") drive - external square 10 mm (3/8"), max. capacity 60 Nm
- 1 adaptor 10 mm (3/8") drive - external square 6.3 mm (1/4"), max. capacity 60 Nm
- 1 adaptor 10 mm (3/8") drive - external square 12.5 mm (1/2"), max. capacity 200 Nm
- 1 adaptor 12.5 mm (1/2") drive - external square 10 mm (3/8"), max. capacity 200 Nm
- 1 adaptor 12.5 mm (1/2") drive - external square 20 mm (3/4"), max. capacity 500 Nm
- 1 adaptor 20 mm (3/4") drive - external square 12.5 mm (1/2"), max. capacity 500 Nm



Item #
200



Impact Adaptor and Universal Joint Set | 6.3 mm (1/4") - 25 mm (1") | 11 pcs.

- suitable for both manual and impact wrenches
- can be fixed on impact wrench by pin and O-ring
- Adaptor 6.3 mm (1/4") drive - external square 10 mm (3/8")
- Adaptor internal square 10 mm (3/8") - external square 6.3 mm (1/4")
- Adaptor internal square 10 mm (3/8") - external square 12.5 mm (1/2")
- Adaptor 12.5 mm (1/2") drive - external square 10 mm (3/8")
- Adaptor 12.5 mm (1/2") drive - external square 20 mm (3/4")
- Adaptor internal square 20 mm (3/4") - external square 12.5 mm (1/2")
- Adaptor internal square 20 mm (3/4") - external square 25.4 mm (1")
- Adaptor internal square 25.4 mm (1") - external square 20 mm (3/4")
- 3 universal joints external/internal square: 6.3 mm (1/4"), 10 mm (3/8"), 12.5 mm (1/2")



Item #
25140



Socket Rails with Clips

- manufactured from metal
- with eye
- suitable for sockets

Item #	Description
2316	Socket Rail with 7 Clips 6.3 mm (1/4")
2120	Socket Rail with 15 Clips 6.3 mm (1/4")
2317	Socket Rail with 7 Clips 10 mm (3/8")
2330	Socket Rail with 15 Clips 10 mm (3/8")
2318	Socket Rail with 7 Clips 12.5 mm (1/2")
2540	Socket Rail with 15 Clips 12.5 mm (1/2")
3460	Socket Rail with 12 Clips 20 mm (3/4")



Socket Rails

6.3  1/4 10  3/8 12.5  1/2

- with locking ball



Item #	Description
9193	Socket Rail with 13 Clips 6.3 mm (1/4")
9194	Socket Rail with 11 Clips 10 mm (3/8")
9195	Socket Rail with 9 Clips 12.5 mm (1/2")

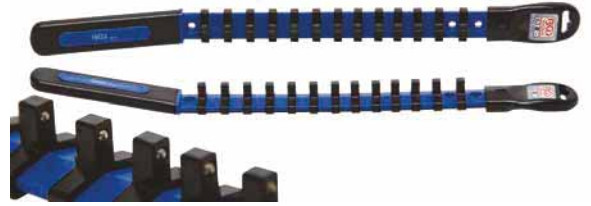

Spinner Handle for bits | external square 6.3 mm (1/4") | 200 mm

- magnetic bit holder
- anti-slip ergonomically formed 2-component handle
- profile: internal hexagon
- drive profile size, metric: 6.3 mm
- length: 200 mm
- drive profile size, inch: 1/4"

Item #		
217		



Bit Screwdriver for Bits with flexible Shaft | 6.3 mm (1/4")

- magnetic bit holder
- anti-slip ergonomically formed 2-component handle
- length: 260 mm

Item #	
7829	



Ratchet Spinner Handle for bits, reversible | 6.3 mm (1/4") drive

- ratchet mechanism with 18 teeth
- magnetic bit holder
- continuously adjustable shaft length from 35 to 145 mm
- 2-component handle
- length: 200 - 305 mm

Item #	
9150	



Spinner Handle | external square 6.3 mm (1/4") | 150 mm

6.3 ■ 1/4

- profile: external square
- drive profile size, metric: 6.3 mm
- length: 150 mm
- surface finish: chrome-plated
- drive profile size, inch: 1/4"



Item #
239



Spinner Handle | external square 6.3 mm (1/4") | 150 mm

6.3 ■ 1/4

- anti-slip ergonomically formed 2-component handle
- profile: external square
- drive profile size, metric: 6.3 mm
- length: 150 mm
- surface finish: satin chrome plated
- drive profile size, inch: 1/4"



Item #
216



Flexible Socket Driver | external square 6.3 mm (1/4")

6.3 ■ 1/4

- anti-slip 2-component handle
- profile: internal square
- drive profile size, metric: 6.3 mm
- overall length: 275 mm
- drive profile size, inch: 1/4"



Item #
7825



Double T-Handles for BGS 7985

- with two bit holders
- Bit holder is optionally available under BGS 1729
- for 6.3 mm (1/4") Bits



Item #
7985-1



T-handles

- ergonomically designed handle
- satin chrome plated



Item #	Description
7800	T-Handle external square 6.3 mm (1/4") 230 mm
7802	T-Handle external square 10 mm (3/8") 230 mm
7805	T-Handle external square 12.5 mm (1/2") 230 mm



T-Handle | wobbly type

- wobble type makes it especially suitable for hard to reach places
- ergonomic handle
- with hanging holes



Item #	Description
7802-1	T-Handle wobbly type 10 mm (3/8") 230 mm
7805-1	T-Handle wobbly type 12.5 mm (1/2") 230 mm



Universal Joints

- satin chrome plated
- DIN 3123



Item #	Description
250	Universal Joint 6.3 mm (1/4")
299	Universal Joint 10 mm (3/8")
251	Universal Joint 12.5 mm (1/2")



Universal Joint Set | with spring | 6.3 mm (1/4") / 10 mm (3/8") / 12.5 mm (1/2") | 3 pcs.

- 1 universal joint, 6.3 mm (1/4")
- 1 universal joint, 10 mm (3/8")
- 1 universal joint, 12.5 mm (1/2")
- surface finish: polished chrome metal



Item #
252



Impact Ball Joint Set | 3 pcs.

6.3  1/4 | 10  3/8 | 12.5  1/2

- suitable for both manual and impact wrenches
- can be fixed on impact wrench by pin and O-ring
- material: chrome molybdenum steel
- 6.3 mm (1/4") drive | external square 6.3 mm (1/4")
- 10 mm (3/8") drive | external square 10 mm (3/8")
- 12.5 mm (1/2") drive | external square 12.5 mm (1/2")



Item #	
9459	

Impact Ball Joint

- suitable for both manual and impact wrenches
- can be fixed on impact wrench by pin and O-ring



Item #	Description
188	Impact Ball Joint 6.3 (1/4")
189	Impact Ball Joint 10 mm (3/8")
190	Impact Ball Joint 12.5 mm (1/2")
197	Impact Ball Joint 20 mm (3/4")



Flexible Handle, extendable | external square 12.5 mm (1/2") | 450 - 600 mm

12.5  1/2

- black finish head
- profile: external square
- drive profile size, metric: 12.5 mm
- length: 450 - 600 mm
- surface finish: satin chrome plated
- max. capacity: 550 Nm
- drive profile size, inch: 1/2"



Item #	  
258	

Flexible Handle with reversible Ratchet | external square 12.5 mm (1/2"), 620 mm

- profile: external square
- drive profile size, metric: 12.5 mm
- length: 620 mm
- max. capacity: 512 Nm
- drive profile size, inch: 1/2"



Item #	Description
228	Flexible Handle with reversible Ratchet external square 12.5 mm (1/2"), 620 mm
228-1	Repair Kit for Flexible Handle for BGS 228



Sliding Adaptors for Extension Bars

- satin chrome plated



Item #	Description
288	Sliding Adaptor for Extension Bars external square 10 mm (3/8")
289	Sliding Adaptor for Extension Bars external square 12.5 mm (1/2")
263-1	Sliding Adaptor for Extension Bars external square 20 mm (3/4")
206	Sliding Adaptor for Extension Bars external square 25 mm (1")



Torque Wrench | 6.3 mm (1/4") | 2 - 10 Nm

6.3  1/4

- 6.3 mm (1/4") drive
- auto-locking
- release with „click signal"
- particularly suitable for tightening the sensors of Tire Pressure Monitoring Systems (TPMS)

Item #
8661



Torque Wrench | 6.3 mm (1/4") | 1 - 5 Nm

6.3  1/4

- incl. bit-adaptor
- auto-locking
- release with „click signal"
- accuracy: $\pm 6\%$
- packed in a plastic case
- length: 235 mm

Item #
975



Digital Torque Wrench | 6.3 mm (1/4") | 1 - 10 Nm

6.3  1/4

- for tightening and loosening of screws with left- and right-hand threads
- perfect for e.g. installation of tire pressure sensors
- incl. adaptor external hexagon 6.3 mm (1/4") to external square 6.3 mm (1/4")
- torque range: 1 - 10 Nm (10 - 100 in-lb)
- operating mode: peak & track
- memory: 10 readings
- unit selection: Nm, Ft-lb, In-lb, Kg-m
- battery: 3 1.5 V AAA (UM-4)
- profile: internal hexagon
- drive profile size, metric: 6.3 mm
- drive profile size, inch: 1/4"
- max. torque: 10 Nm
- min. torque: 1 Nm
- battery type: 3 AAA | 1.5 V
- operating temperature: -10 - +55 °C
- accuracy left/right: +/- 1 / +/- 1.5 %
- storage temperature: -40 - 85 °C
- humidity: 0 - 90 %

Item #
956



Torque Wrenches

- reversible ratchet with automatic release via click signal
- set torque is locked by stop screw
- delivered with calibration certificate

Item #	Description
960	Torque Wrench 6.3 mm (1/4") 5 - 25 Nm
959	Torque Wrench 10 mm (3/8") 5 - 25 Nm
962	Torque Wrench 10 mm (3/8") 7 - 105 Nm
98	Torque Wrench + Adaptor + Extension Bar 12.5 mm (1/2") 28 - 210 Nm
964	Torque Wrench 12.5 mm (1/2") 70 - 350 Nm



Torque Wrenches

- reversible ratchet with automatic release via click signal
- set torque is locked by sliding bush
- high precision
- delivered with calibration certificate

Item #	Description
967	Torque Wrench 6.3 mm (1/4") 6 - 30 Nm
966	Torque Wrench 10 mm (3/8") 20 - 110 Nm
965	Torque Wrench 12.5 mm (1/2") 42 - 210 Nm
971	Torque Wrench 12.5 mm (1/2") 70 - 350 Nm
968	Torque Wrench 20 mm (3/4") 100 - 500 Nm
969	Torque Wrench 20 mm (3/4") 140 - 700 Nm
990	Torque Wrench 20 mm (3/4") 140 - 980 Nm
970	Torque Wrench 25 mm (1") 140 - 980 Nm



Torque Wrench | 6.3 mm (1/4") | 1 - 6 Nm

6.3  1/4

- Reversible ratchet with quick release button
- clicks when the previously set torque value is reached
- right side use only
- resolution: +/- 4%
- delivered with calibration certificate

Item #
954



Torque Wrenches

6.3 1/4 | 10 3/8 | 12.5 1/2

- ratcheting head, reversible, 48 teeth
- suitable on screws with right **and left hand thread**
- torque display in both directions
- viewing window for torque value
- Resolution: +/- 4%, incl. test certificate
- **BGS 2803**
Torque range: 5 - 25 Nm
Fine scale: 0.1 Nm
Length: 320 mm
- **BGS 2804**
Torque range: 20 - 100 Nm
Fine scale: 0.5 Nm
Length: 401 mm
- **BGS 2805**
Torque range: 40 - 200 Nm
Fine scale: 0.5 Nm
Length: 500 mm
- **BGS 2806**
Torque range: 60 - 640 Nm
Fine scale: 1.0 Nm
Length: 604 mm
- **BGS 2807**
Torque range: 150 - 750 Nm
Fine scale: 2.5 Nm
Length: 1210 mm
- **BGS 2808**
Torque range: 200 - 1000 Nm
Fine scale: 2.5 Nm
Length: 1500 mm



Item #	Description
2803	Torque Wrench 6.3 mm (1/4") 5 - 25 Nm
2804	Torque Wrench 10 mm (3/8") 20 - 100 Nm
2805	Torque Wrench 12.5 mm (1/2") 40 - 200 Nm
2806	Torque Wrench 12.5 mm (1/2") 60 - 340 Nm
2807	Torque Wrench 20 mm (3/4") 150 - 750 Nm
2808	Torque Wrench 25 mm (1") 200 - 1000 Nm

Torque Wrench Set | 6.3 mm (1/4") | 6 - 30 Nm | 10 pcs.

6.3 1/4

- with interchangeable heads
- reversible ratchet head with external square 6.3 mm (1/4")
- 8 open end spanner heads in following sizes: 7 - 8 - 9 - 10 - 11 - 12 - 13 - 14 mm

Item #
8856



Torque Wrench | 10 mm (3/8") | 13.6 - 108.5 Nm

10  3/8

- set torque is locked by stop crew
- incl. adaptor 10 mm (3/8) to 12.5 mm 1/2"
- length: 280 mm

Item #
961



Digital Torque Wrench | 12.5 mm (1/2") | 20 - 200 Nm

12.5  1/2

- for precise adjustment of the torque
- digital display
- always shows current torque in display when working
- works in both left and right direction
- torque can be displayed via push button
- makes acoustic signal when reaching the preset torque
- torque can be displayed in NM, ft-lb, lbf-inch
- profile: external square
- drive profile size, metric: 12.5 mm
- max. torque: 200 Nm
- min. torque: 20 Nm
- drive profile size, inch: 1/2"

Item #
973



Torque Wrench Set | 40 - 210 Nm | 11 pcs.

12.5  1/2

- includes calibration certificate
- 9 open end spanner heads 13 - 14 - 15 - 17 - 19 - 22 - 24 - 27 - 30 mm
- 14 x 18 mm square drive for open end heads

Item #
958



Torque Wrench | left/right | 12.5 mm (1/2") | 70 - 350 Nm

- left and right operation
- "Go-thru" square head for changing the direction
- automatic triggering by click signal
- set torque is locked by sliding bush
- profile: external square
- drive profile size, metric: 12.5 mm
- length: 650 mm
- max. torque: 350 Nm
- min. torque: 70 Nm
- drive profile size, inch: 1/2"

Item #
2798



Torque Multiplier Set | 25 mm (1") | 10 pcs.

25 ■ 1

- for loosening stuck wheel nut sockets on trucks and vans
- maximum torque 3200 Nm
- gear ratio 1:56
- includes 7 sockets made from chrome vanadium steel
- socket sizes: 24 - 27 - 30 - 32 - 33 - 36 - 38 mm



Item #	Description
1230	Torque Multiplier Set 25 mm (1") 10 pcs.
1230-REPAIR	Torque Multiplier Repair Kit for BGS 1230

Torque Multiplier

25 ■ 1

- for loosening stuck wheel nut sockets on trucks and vans
- maximum torque 3200 Nm
- gear ratio 1:56



Item #
1230-1

Torque Multiplier Set | 12.5 mm (1/2") + 20 mm (3/4") | 6 pcs.

12.5 ■ 1/2 20 ■ 3/4

- 12.5 mm (1/2") drive, max. torque absorption 300 Nm
- 20 mm (3/4"), max. torque 1,000 Nm
- gear rate 1:4, torque rate 1:3,3
- overall length (with straight handle bar) 460 mm
- can alternatively be combined with an angle bar that abridges in the rim
- includes 12.5 mm (1/2") ratchet with quick release function (finely toothed) and crank handle for quick and easy spinning
- includes power adaptor 20 mm (3/4") drive x 12.5 (1/2") output for working on standard wheel nuts
- length: 460 mm



Item #	Description
1204	Torque Multiplier Set 12.5 mm (1/2") + 20 mm (3/4") 6 pcs.
1204-REPAIR	Torque Multiplier Repair Kit for BGS 1204

Torsion Bar Set | 5 pcs.

12.5  1/2

- 100 - 110 - 120 - 135 - 150 NM
- length 195 mm

Item #	Description
185	Torsion Bar Set 5 pcs.
186	Torsion Bar 100 Nm
187	Torsion Bar 110 Nm
185-120	Torsion Bar 120 Nm
185-135	Torsion Bar 135 Nm
185-150	Torsion Bar 150 Nm



Digital Torque Adaptor

- allows to use a ratchet as a torque wrench
- accuracy +/- 2%
- for right- and leftside operation

Item #	Description
979	Digital Torque Adaptor 6.3 mm (1/4") 6 - 30 Nm
978	Digital Torque Adaptor 10 mm (3/8") 27 - 135 Nm
977	Digital Torque Adaptor 12.5 mm (1/2") 40 - 200 Nm



Angular Gauge for angular torque | 12.5 mm (1/2") drive

12.5  1/2

- use in combination with torque wrenches, ratchets, sockets and accessories
- to accurately set the angle required
- scale 90 mm Ø, 0 - 360°, 2° partition

Item #
3070



Angle Gauge | 12.5 mm (1/2") drive

- angle scale: 0 - 360°
- stop screw

Item #
3084



Angular Gauge with clip arm | 12.5 mm (1/2") drive

12.5 \square 1/2

- precise workshop finish
- to accurately set the angle required
- max. capacity approx. 280 Nm

Item #
3169



Angular Gauge with magnetic arm | 12.5 mm (1/2") drive

12.5 \square 1/2

- precise workshop finish
- to accurately set the angle required
- max. capacity approx. 280 Nm

Item #
3170



Angular Gauge with magnetic arm | 20 mm (3/4") drive

20 \square 3/4

- precise workshop finish
- to accurately set the angle required

Item #
8439



Repair Sets for Torque Wrenches

Item #	Description
2798-REPAIR	Torque Wrench Repair Kit for BGS 2798
2799-REPAIR	Torque Wrench Repair Kit for BGS 2799
2800-REPAIR	Torque Wrench Repair Kit for BGS 2800
2801-REPAIR	Torque Wrench Repair Kit for BGS 2801
2803-REPAIR	Torque Wrench Repair Kit for BGS 2803
2804-REPAIR	Torque Wrench Repair Kit for BGS 2804
2805-REPAIR	Torque Wrench Repair Kit for BGS 2805
2806-REPAIR	Torque Wrench Repair Kit for BGS 2806
958-REPAIR	Torque Wrench Repair Kit for BGS 958
959-REPAIR	Torque Wrench Repair Kit for BGS 959
965-1	Spare Ratchet Plate for Torque Wrench + for BGS 965
965-2	Spare Ratchet Plate for Torque Wrench - for BGS 965
965-REPAIR	Torque Wrench Repair Kit for BGS 965
966-REPAIR	Torque Wrench Repair Kit for BGS 966
967-REPAIR	Torque Wrench Repair Kit for BGS 967, 960
968-1	Spare Ratchet Plate for Torque Wrench + for BGS 968
968-2	Spare Ratchet Plate for Torque Wrench - for BGS 968
968-REPAIR	Torque Wrench Repair Kit for BGS 968, 990
969-REPAIR	Torque Wrench Repair Kit for BGS 969, 990
970-REPAIR	Torque Wrench Repair Kit for BGS 970
971-REPAIR	Torque Wrench Repair Kit for BGS 971, 964
973-REPAIR	Torque Wrench Repair Kit for BGS 973
2808-REPAIR	Torque Wrench Repair Kit for BGS 2808
2807-REPAIR	Torque Wrench Repair Kit for BGS 2807



External / internal Puller, 2-arm | max. 75 mm

- suitable as inside and outside puller
- clamping width max. 70 mm
- clamping depth 37 mm
- forged



Item #
9408



External / internal 2-Arm Puller

- can be used as internal / external Puller
- forged



Item #	Description
7690	External / internal 2-Arm Puller 65 - 100 mm
7691	External / internal 2-Arm Puller 75 - 115 mm
7692	External / internal 2-Arm Puller 76 - 165 mm
7693	External / internal 2-Arm Puller 150 - 210 mm
7694	External / internal 2-Arm Puller 210 - 300 mm
7695	External / internal 2-Arm Puller 225 - 310 mm

External / internal 2-Arm Puller

- forged
- galvanized, zinc coated
- reversible



Item #	Description
7713	External / internal 2-Arm Puller 15 - 120 mm
7714	External / internal 2-Arm Puller 20 - 140 mm
7716	External / internal 2-Arm Puller 25 - 195 mm
7718	External / internal 2-Arm Puller 40 - 225 mm

Parallel Puller, fine Thread, 2-legs | 40 - 95 mm

- forged
- mechanic puller with standard hooks
- parallel puller hooks in every working position, can be used for inside and outside pulling via detachable and adjustable puller hooks



Item #
7780

Parallel Puller, fine Thread, 2-legs | 50 - 130 mm

- forged
- mechanic puller with standard hooks
- parallel puller hooks in every working position, can be used for inside and outside pulling via detachable and adjustable puller hooks

Item #
7781



Parallel Puller, fine Thread, 2-legs | 50 - 150 mm

- forged
- mechanic puller with standard hooks
- parallel puller hooks in every working position, can be used for inside and outside pulling via detachable and adjustable puller hooks

Item #
7782



Parallel Puller, fine Thread, 2-legs | 40 - 200 mm

- forged
- mechanic puller with standard hooks
- parallel puller hooks in every working position, can be used for inside and outside pulling via detachable and adjustable puller hooks

Item #
7783



Parallel Puller, fine Thread, 2-legs | 50 - 240 mm

- forged
- parallel puller hooks in every working position, can be used for inside and outside pulling via detachable and adjustable puller hooks

Item #
7784



Universal Puller Set, 2-arm | 35 - 130 mm | 7 pcs.

- suitable as inside and outside puller



Item #
7785

External / internal 3-Arm Puller

- Can be used as Internal / External Puller



Item #	Description
7696	External / internal 3-Arm Puller 20 - 100 mm
7697	External / internal 3-Arm Puller 25 - 120 mm
7698	3-Arms External / internal Puller 30 - 150 mm
7699	External / internal Puller 3-arm 40 - 210 mm
7700	3-Arms External / internal Puller 50 - 300 mm
7701	External / internal Puller 3-arm 50 - 300 mm

External / internal 3-Arm Puller

- forged
- reversible
- surface finish: galvanised, electroplated



Item #	Description
7723	External / internal Puller 3-arm 20 - 100 mm
7724	External / internal Puller 3-arm 20 - 110 mm
7726	3-Arms External / internal Puller 25 - 160 mm
7728	External / internal Puller 3-arm 30 - 210 mm

Pullers

External / internal Puller, 2-arm | 50 - 145 mm / 70 - 170 mm

- suitable as inside and outside puller
- Clamping range as inside puller 50 - 145 mm
- Clamping range as external puller 70 - 170 mm
- slotted puller arm also suitable for small sleeves, bearing, gears, pulleys etc.
- structured puller arm for better grip
- good centering by cone-shaped pressure piece
- incl. flat pressure piece
- spindle drive is possible via internal square 1/2", external hexagon 21 mm or rod
- spindle made of carbon steel
- max. clamping width outside puller 170 mm
- max. clamping width inside puller 145 mm
- min. clamping width outside puller 70 mm
- min. clamping width inside puller 50 mm



Item #
7737

Miniature Puller, 3-arm | 19 - 45 mm

- especially for quick pulling of small ball-bearings
- for air-condition, generators, electronic pumps, impact tools, standard house holding machines, etc.



Item #
7738

External / internal Puller Set, 2 and 3-arm | 13 pcs.

- puller depth: 105 - 210 mm and 265 mm
- puller legs are suitable for 2- and 3-leg crossbars, puller width: up to 135 mm
- free moving legs allow internal and external pulling operations
- hardened pulling feet (width approx. 25 mm, thickness approx. 4 mm)
- 2 spindles approx. 165 mm and 280 mm with M14 x 1.5 mm thread

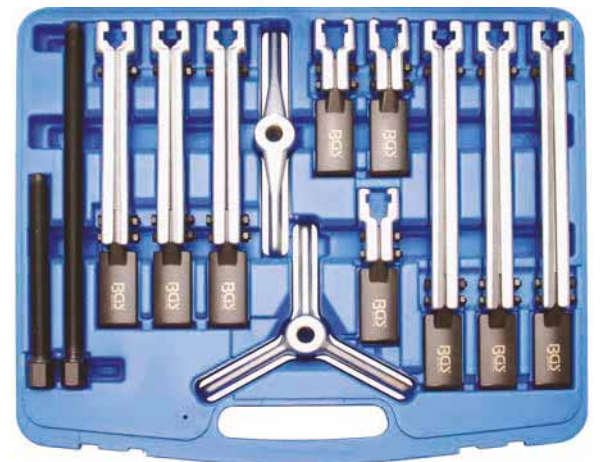

Item #	Description
7760	External / internal Puller Set, 2 and 3-arm 13 pcs.
7760-LEER	Empty Case for BGS 7760
7760-1	Spare Hook Leg for BGS 7760
7760-2	Spare Claw for Puller extra slim 3 pcs. for BGS 7760

External / internal Puller, 2 and 3-arm

- can be used with 2 or 3 arms
- clamping width: 76-102 mm (BGS 7790) or 76-178 mm (BGS 7791)
- clamping depth up to 100 mm (BGS 7790) or up to 180 mm (BGS 7791)



Item #	Description
7790	External / internal Puller, 2 and 3-arm 76 - 102 mm
7791	External / internal Puller, 2 and 3-arm 76 - 178 mm

Bearing Puller Set | 10 pcs.

- max. puller depth 200 mm
- clamping width: 20 - 100 mm
- interchangeable heads Ø 5.5 - 6 - 8 mm



Item #
7744

Splitting Knife Set for Ball Bearing Assemblies | 14 pcs.

- incl. shifter
- for removing bearings, internal rings and other tightly and narrowly mounted parts
- clamping width (A) min. / max. in mm: min. 17 mm / max. 60 mm
- puller bolt receiving thread (B): 3/8" x 16 UNC
- clamping bolt distance (C) in mm: 90 mm
- clamping bolt thread (D): 1/2" x 20 UNF
- puller bolt distance (E) min. / max. in mm: min. 84 mm / max. 127 mm
- clamping bolt length (F): 136 mm
- splitting knife base (G) min. / max. in mm: min. 52 mm / max. 95 mm
- clamping width (A) min. / max. in mm: min. 8 mm / max. 64 mm
- puller bolt receiving thread (B): 3/8" x 16 UNC
- clamping bolt distance (C) in mm: 63 mm
- clamping bolt thread (D): 3/8" x 24 UNF
- puller bolt distance (E) min. / max. in mm: min. 50 mm / max. 106 mm
- clamping bolt length (F): 125 mm
- splitting knife base (G) min. / max. in mm: min. 26 mm / max. 82 mm



Item #	Description
7750	Splitting Knife Set for Ball Bearing Assemblies 14 pcs.
7750-LEER	Empty Case for BGS 7750

Ball Bearing Separator

- drop forged
- chrome plated

BGS 7741

- bolts Ø: 9.5 mm x 125 mm
- bolt threads: 3/8" x 24 UNF
- splitting knife thread: 3/8" x 16 UNC

BGS 7749

- bolts Ø: 12.7 x 135 mm
- bolt threads: 1/2" x 20 UNF
- splitting knife thread: 3/8" x 16 UNC

BGS 7742

- bolts Ø: 16 mm x 165 mm
- bolt threads: 5/8" x 18 UNF
- splitting knife thread 1/2" x 13 UNC

BGS 8767

- bolts Ø: 19 mm, 260 mm
- bolt threads: 3/4" x 16 UNF
- splitting knife thread 5/8" x 11 UNC

BGS 8768

- bolts Ø 25.5 mm, 350 mm
- bolt threads: 1" x 12 UNF
- splitting knife thread 3/4" x 10 UNC

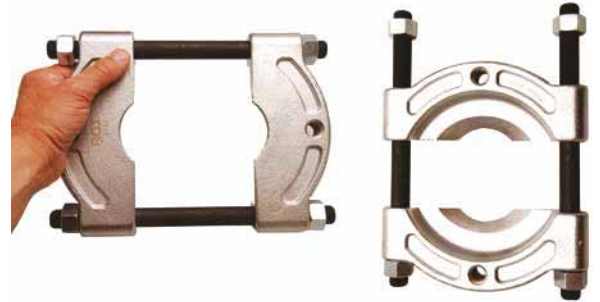

Item #	Description
7741	Ball bearing Separator 5 - 63 mm
7749	Ball Bearing Separator 12 - 62 mm
7742	Ball Bearing Separator 18 - 83 mm
8767	Ball Bearing Separator 29 - 168 mm
8768	Ball Bearing Separator 39 - 225 mm

Splitting Knife Set for Ball Bearing Assemblies | 6 pcs.

- total length of central bolt is 290 mm
- see BGS 7742 for separate splitting knife
- clamping width (A) min. / max. in mm: min. 13 mm / max. 70 mm
- puller bolt receiving thread (B): 1/2" x 13 UNC
- clamping bolt distance (C) in mm: 113 mm
- camping bolt thread (D): 1/2" x 13 UNC
- puller bolt distance (E) min. / max. in mm: min. 90 mm / max. 147 mm
- clamping bolt length (F): 166 mm
- splitting knife base (G) min. / max. in mm: min. 57 mm / max. 114 mm

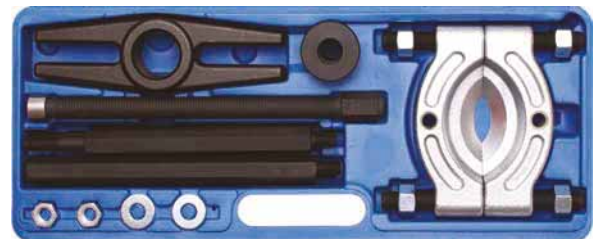

Item #
7753

Hydraulic Puller | 10 t

- hydraulic ram 10 ton
- 2 extension rods
- one twin head and one triple head
- 3 legs each in 100, 150 und 200 mm lengths:
- max. pulling width:
 - 240 mm at 100 mm puller legs length
 - 280 mm at 150 mm puller legs length
 - 300 mm at 200 mm puller legs length
- clamping width (A) min. / max. in mm: min. 14 mm / max. 62 mm
- puller bolt receiving thread (B): 5/8" x 18 UNF
- clamping bolt distance (C) in mm: 111 mm
- clamping bolt thread (D): 5/8" x 18 UNF
- puller bolt distance (E) min. / max. in mm: min. 64 mm / max. 210 mm



Item #
7729

Hydraulic Spindle for Puller and Ejector | 12 t

- produces up to 12 t pressure
- to be used with BGS 7729, 1525, 7774
- can be operated by spinner bar or socket
- thread: UN 1-1/2"x16



Item #	Description
7721-X	Hydraulic Spindle for Puller and Ejector 12 t
7721-X-KAPPE	Press Cap for BGS 7721-X

Blind Hole Bearing Puller Set | 10 pcs.

- puller bolt and adaptors for use with slide hammer and two-arm pullers
- 1 sliding hammer 910 g, length: 285 mm
- 1 puller with puller width 125 mm
- 5 extraction mandrels for extracting of bearings with inner diameter 7 - 29 mm
- 3 adaptors for extracting components with internal thread M6 x 1.0 - M8 x 1.25 - M10 x 1.5

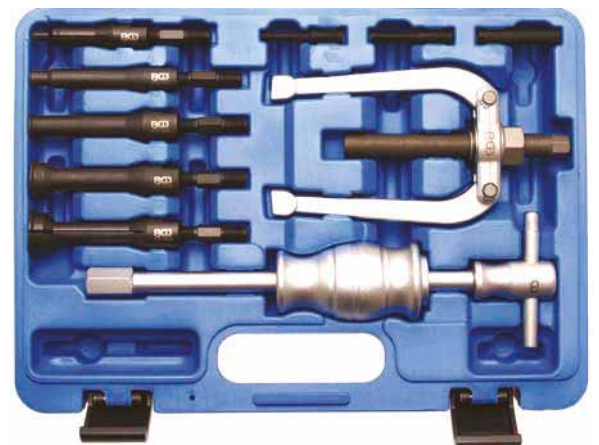

Item #	Description
7710	Blind Hole Bearing Puller Set 10 pcs.
7710-1	Puller with Spindle max. 125 mm for BGS 7710
7710-12x17	Pulling Mandrel with Spindle 12 x 17 mm for BGS 7710
7710-18x23	Pulling Mandrel with Spindle 18 x 23 mm for BGS 7710
7710-24x29	Pulling Mandrel with Spindle 24 x 29 mm for BGS 7710
7710-30x34	Pulling Mandrel with Spindle 30 x 34 mm for BGS 7710
7710-8x11	Pulling Mandrel with Spindle 8 x 11 mm for BGS 7710

External / internal Puller Set | 5 pcs.

- for shaft seals
- hardened carbon steel
- external triple leg puller 40 to 80 mm
- internal triple leg puller 50 to 150 mm
- 1 deep puller
- 1 convex screw connection

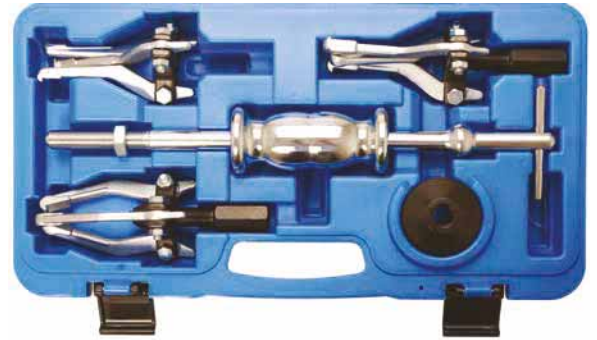

Item #	Description
7734	External / internal Puller Set 5 pcs.
7734-2	Sliding Hammer for internal/External Puller for BGS 7734

Steering Wheel Puller Set | 87 - 153 mm | 8 pcs.

- all-purpose
- esp. for Opel and Ford
- leg length optional 87 or 153 mm

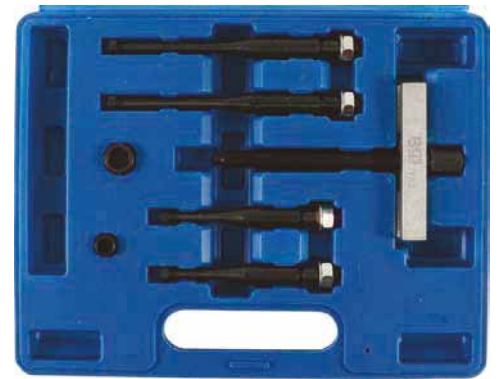

Item #
7752

Bearing Inner Ring Puller | for Mercedes | 11 pcs.

- for removing the inner bearing ring from the wheel hub
- fits on most vehicles with ring diameter 56 - 68 mm
- 3 pullers, suitable for e.g. the following models:
 - 56 - 60 mm: Mercedes W168
 - 60 - 64 mm: Mercedes W201, W202, W203, W210, W214, BMW, Peugeot
 - 64 - 68 mm: Mercedes W163, W140, W169, W211, W220, W245, W124T
- Special handle
- ring wrench 36 mm
- Spindle M20 x 1.5
- 2 pressure pieces



Item #
7764

Belt Pulley Puller Set | 10 pcs.

- for pulling and installing of belt pulleys on power steering pumps, generators, fan wheels, etc.
- 2 cross beams: 140 mm, 230 mm
- 2 pairs of straight pullers: length: 60 mm, 110 mm
- 1 pair of specifically formed pullers length 60 mm
- all pullers and cross beams can be combined
- suitable for pulleys up to Ø 200 mm

Item #
7770



Belt Pulley Puller | 40 - 168 mm

- pulling range 40 - 168 mm
- for generators, air conditioners, water pumps
- includes 10 mm hex wrench

Item #
7779



Special Puller, extra long | 10 - 50 mm

- external puller for deeply set bearings etc.
- hardened

Item #
7731



Toothed Belt wheel Puller | universal

- draws pulleys by the holes without causing damage
- suitable for different bolt patterns and distances
- 8 slots for holding pulling legs in different positions
- 18 mm pulling legs
- Ø 16 mm spindle with centering ball 24 mm drive

Item #
8273



Bearing Ring Puller, 3-arm | universal | 10 - 125 mm

- for removing of bearing ring and sleeves
- ultra sharp jaw edges allow to clamp in between 0.5 mm
- suitable for bearing rings and sleeve diameters from 10 to 125 mm
- extractor can be pre-tensioned by closing the cone



Item #
8903

Camshaft Sprocket and Ribbed Drive Puller | 42 - 82 mm

- for removing pulleys and camshaft sprockets
- pulling arms are interconnected by adjusting disc, this allows easy and precise setting of pulling arms
- stepless range of pulling arms: from 42 to 82 mm adjustable
- pulling depth: 27 mm
- 3 pulling arms, Ø 12 mm, M10 x 1.5 suitable for material thickness up to max. 10 mm
- puller body with 6 grooves and adjusting disc
- spindle M14 x 1.5, 19 mm hexagon, with centering ball



Item #
8964

Hand Axe | Head Weight 600 g

- gold coloured head
- two-coloured handle, wooden



Item #
2136

Axes and Hatchets | fibreglass shaft

- non-slip rubber coated grip

Item #	Description
3800	Hand Axe with Fibreglass Shaft 600 g
3830	Hand Axe with Fibreglass Shaft 1250 g



Chopper with Fibreglass Shaft | 3000 g

- wedged and cast head
- satin black lacquered finish
- non-slip rubber coated shaft
- length: 900 mm
- material handle: fibre glass
- head weight: 3000 g

Item #
3834



Hole Saw Set | Ø 22 - 65 mm | depth 40 mm | 8 pcs.

- 6 HSS-BI-METAL holesaws
- 2 mandrel holders with pilot drill
- for metal, plastic and wood
- saws Ø 22 - 29 - 35 - 44 - 51 - 65 mm, depth 40 mm



Item #	Description
3906	Hole Saw Set Ø 22 - 65 mm depth 40 mm 8 pcs.
3906-1	Spare Centre Drill 73 / 104 mm

Tile Drill Bit Set | 33 - 73 mm | 6 pcs.

- carbide tipped
- incl. 4 holesaws - Ø 33, 53, 67 + 73 mm
- mandrel holder and pilot drill



Item #	Description
3910	Tile Drill Bit Set 33 - 73 mm 6 pcs.
3911	Drill Bit for Tile Hole Saw Ø 33 mm
3913	Drill Bit for Tile Hole Saw Ø 67 mm
3914	Drill Bit for Tile Hole Saw Ø 73 mm
3915	Backing Disc for Tile Driller
3916	Centre Drills for Tile Holesaw



Diamond Core Drill Bit Set | 5 pcs.

- 5 drill bits Ø 6, 8, 10, 12, 25 mm
- suitable for: Glass, ceramic tiles, marble, etc.
- Shaft holder 6.3 mm (1/4")

Item #
3917



HSS Drill Set | 13 - 25 mm | 8 pcs.

- with 13 mm shank, drills fits in many "normal" drill chucks as well as standard drills
- sizes: 13 - 14 - 15 - 16 - 18 - 20 - 22 - 25 mm
- in wooden box
- material: HSS-steel

Item #
2019



HSS Drill Set | 14 - 16 - 18 - 20 mm | 4 pcs.

- dimensions 14 - 16 - 18 - 20 mm
- beveled shaft, Ø 13 mm
- material: HSS-steel



Item #
8985



HSS Drill Set | 22 - 24 - 25 mm | 3 pcs

- sizes: 22 - 24 - 25 mm
- beveled shaft, Ø 13 mm
- material: HSS-steel



Item #
8986



Twist Drill Sets | HSS

- drills manufactured in accordance with DIN 338
- fully ground drills (BGS 2000)
or rolled (BGS 1994+1995)
- 1.0-8.0 mm, 0.5 mm ascending steps: 10 pcs. each size
- 8.5-10.0 mm, 0.5 mm ascending steps: 5 pcs. each size



Item #	Description
2000	Twist Drill Set HSS 5% cobalt alloy 1 - 10 mm 170 pcs.
1994	Twist Drill Set HSS titanium nitrated 1 - 10 mm 170 pcs.
1995	Twist Drill Set HSS Ø 1 - 10 mm 170 pcs.
1995-LEER	Metal empty Case for BGS 1995

Twist & Step Drill Set | HSS | titanium nitrated | 1 - 10 mm | 119 pcs.

- manufactured in accordance with DIN 338
- ground edges

Twist drills:

- 15 x Ø 1.0 mm
- 15 x Ø 1.5 mm
- 10 x Ø 2.0 mm
- 10 x Ø 2.5 mm
- 12 x Ø 3.0 mm
- 10 x Ø 3.5 mm
- 12 x Ø 4.0 mm
- 10 x Ø 4.5 mm
- 8 x Ø 5.0 mm
- 8 x Ø 6.0 mm
- 3 x Ø 7.0 mm
- 3 x Ø 8.0 mm
- 2 x Ø 10.0 mm

Stepped drills

- each 1 x Ø 4 - 25 mm

Item #
2009



Drills

Twist Drill Set | HSS-G M35 Cobalt Steel | 1 - 13 mm | 25 pcs.

- Pointed angle: 135 degree
- shaped
- twist drill 1 - 1.5 - 2 - 2.5 - 3 - 3.5 - 4 - 4.5 - 5 - 5.5 - 6 - 6.5 - 7 - 7.5 - 8 - 8.5 - 9 - 9.5 - 10 - 10.5 - 11 - 11.5 - 12 - 12.5 - 13 mm

Item #
116



HSS Twist Drill Set | Ø 1 - 13 mm | 25 pcs

- fully ground, cross joint tips
- twist drill 1 - 1.5 - 2 - 2.5 - 3 - 3.5 - 4 - 4.5 - 5 - 5.5 - 6 - 6.5 - 7 - 7.5 - 8 - 8.5 - 9 - 9.5 - 10 - 10.5 - 11 - 11.5 - 12 - 12.5 - 13 mm
- material: HSS-steel
- surface finish: polished

Item #
110



Twist Drill Set | HSS | Ø 1 - 13 mm | 25 pcs.

- 0.5 mm steps
- rolled
- drills manufactured from HSS steel
- ground edges
- material: HSS-steel



Item #
2021

Twist Drill Set | HSS-G M35 Cobalt Steel | 1 - 10 mm | 19 pcs.

- made of HSS-G M35 cobalt steel, for longer service life
- Twist drill 1.0 - 1.5 - 2.0 - 2.5 - 3.0 - 3.5 - 4.0 - 4.5 - 5.0 - 5.5 - 6.0 - 6.5 - 7.0 - 7.5 - 8.0 - 8.5 - 9.0 - 9.5 - 10.0 mm



Item #
9297

Twist Drill | HSS G | titanium nitrated | 1 - 10 mm | 19 pcs.

- fully ground drills
- tip with 135° split point
- Twist drill 1.0 - 1.5 - 2.0 - 2.5 - 3.0 - 3.5 - 4.0 - 4.5 - 5.0 - 5.5 - 6.0 - 6.5 - 7.0 - 7.5 - 8.0 - 8.5 - 9.0 - 9.5 - 10.0 mm



Item #	Description
2040	Twist Drill HSS G titanium nitrated 1 - 10 mm 19 pcs.
2040-1	Twist Drill HSS-G titanium-nitrated 1.5 mm 2 pcs.
2040-1.5	Twist Drill HSS-G titanium-nitrated 1.5 mm 2 pcs.
2040-2	Twist Drill HSS-G titanium-nitrated 2.0 mm 2 pcs.
2040-2.5	Twist Drill HSS-G titanium-nitrated 2.5 mm 2 pcs.
2040-3	Twist Drill HSS-G titanium-nitrated 3.0 mm 2 pcs.
2040-3.5	Twist Drill HSS-G titanium-nitrated 3.5 mm
2040-4	Twist Drill HSS-G titanium-nitrated 4.0 mm
2040-4.5	Twist Drill HSS-G titanium-nitrated 4.5 mm
2040-5	Twist Drill HSS-G titanium-nitrated 5.0 mm
2040-5.5	Twist Drill HSS-G titanium-nitrated 5.5 mm
2040-6	Twist Drill HSS-G titanium-nitrated 6.0 mm
2040-6.5	Twist Drill HSS-G titanium-nitrated 6.5 mm
2040-7	Twist Drill HSS-G titanium-nitrated 7.0 mm
2040-7.5	Twist Drill HSS-G titanium-nitrated 7.5 mm
2040-8	Twist Drill HSS-G titanium-nitrated 8.0 mm
2040-8.5	Twist Drill HSS-G titanium-nitrated 8.5 mm
2040-9	Twist Drill HSS-G titanium-nitrated 9.0 mm
2040-9.5	Twist Drill HSS-G titanium-nitrated 9.5 mm
2040-10	Twist Drill HSS-G titanium-nitrated 10.0 mm



Drills

Twist Drill Set | HSS | titanium nitrated | 1 - 10 mm | 19 pcs.

- roll forged
- 0,5 mm steps

Item #
2013



Twist Drill Set | HSS | 1 - 10 mm | 19 pcs.

- roll forged
- 0,5 mm steps



Item #
2014

HSS Mini Drill Set | 0.5 - 3.0 mm | 25 pcs.

- includes following HSS drills: 5 x 0.5 mm - 5 x 0.6 mm - 3 x 1.0 mm - 2 x 1.2 mm - 2 x 1.5 mm - 2 x 1.8 mm - 2 x 2.0 mm - 2 x 2.35 mm - 2 x 3.0 mm



Item #
2023



Drill Set | HSS | left cutting | 4 pcs.

- sizes: Ø 3 mm, length 60 mm - Ø 4 mm, length 75 mm - Ø 6 mm, length 93 mm - Ø 7 mm, length 108 mm
- for drilling broken screws, bolts, etc.
- in wooden case
- surface finish: titanium-nitrided



Item #	Description
2726	Drill Set HSS left cutting 4 pcs.
2726-3	HSS Drill, left-cutting Ø 3.0 mm
2726-4	HSS Drill, left-cutting Ø 4.0 mm

Drill Set | left cutting | 5 pcs.

- sizes: 3 - 5 - 6 - 8 - 10 mm
- material: Cobalt steel (5%)



Item #
2731



Auger Drill Bit Set | 200 mm | 6 pcs.

- with hexagon shaft
- for hard and soft wood
- includes 6 drills with diameter: 10 - 12 - 14 - 16 - 18 - 20 mm
- length 200 mm
- in wooden box

Item #
2894



Wood Crown and Milling Drill Set | 4 - 12 mm | 6 pcs.

- 5 cutting-crown heads with center tip
- 4 shoulder blades
- special spiral profile, extreme sharp milling cutter
- fast chip removal
- for exact tapping & milling, rotation file and hole saw
- sizes 4 - 6 - 8 - 10 - 12 mm and 12 mm countersink

Item #
50401



Centre Bit Drill / Wood Drill Set | 14 pcs.

- Ø 3 - 4 - 5 - 6 - 7 - 8 - 9 - 10 - 11 - 12 - 13 mm
- centre bit, 3 pcs.: adjustable from 15 - 25 mm and 25 - 45 mm
- drills holes from 3 to 45 mm
- all drills with centering tip

Item #
50403



High Precision Drill Set | 150 pcs.

- grinding, polishing and cutting equipment for mini drills and grinding machines, up to 26000 rpm
- 3 mm shaft
- 12 grinding heads with 120 grit, for cleaning grinding, polishing of metal
- 10 grinding wheels with 120 grit, for cleaning grinding, polishing of stone, glass, ceramics, porcelain
- 12 sand paper belts with 80 grit, for coarse sharpening and smoothing of wood and fiberglass
- wing disc for coarse grinding and smoothing of wood and fiberglass
- diamond cutter 5 pieces for fine grinding of precious stones, ceramics, glass and wood
- carbide Cutter 3.2 mm ball head for hardened steel cast steel, stainless steel, ceramic
- HSS cutter 3.2 x 9.5 mm for soft metals, fibre glass, plastic, wood
- 71 cutting disc for cutting metal wood, plastic
- 2 rubber discs 22 x 4 mm for cleaning grinding, polishing of silver and jewelry
- surface brush 19 x 44 mm for cleaning, grinding polishing of silver and jewelry
- 2 round brushes 9.5 x 44 mm for cleaning grinding, polishing of silver and jewelry
- stainless steel brush 19 x 44 mm round type to remove rust and polishing of metals
- stainless steel surface brush 12.7 x 44 mm for removing rust and polishing of metals
- round brass brush 12.7 x 44 mm for removing rust and polishing of metals
- 11 polishing discs for polishing metals and plastics
- each 2 HSS drills 2.4 and 1.6 mm
- shaft adaptor 1.6 / 2.4 and 3.2 mm
- 2 cutting discs with 1.6 and 2.4 mm hole
- sharpening stone
- fork spanner
- in practical transparent cassettes



Item #
8060



HSS G-Multi Drill Set | 4 pcs.

- step drill 4 - 12 mm
- hole cutter 8 - 20 mm
- drill saw 6 x 90 mm
- countersink 12,4 mm



Item #
1944



Twist Drill / Tap Set | 14 pcs.

- twist drills: Ø 2.5 - 3.3 - 4.2 - 5.0 - 6.8 - 8.5 - 10.2 mm
- twist drills manufactured in accordance with DIN 338: M3 - M4 - M5 - M6 - M8 - M10 - M12, taps manufactured in accordance with DIN 371/376 B



Item #
9296

Drill Grinding Attachment | for twist drills, Ø 3 - 19 mm

- for drills Ø 3 - 19 mm



Item #
3200

Socket Set, Hexagon, extra long | 6.3 mm (1/4") drive | for electric drills | 6 - 13 | 8 pcs. **6.3** **1/4**

- Sizes: 6 - 7 - 8 - 9 - 10 - 11 - 12 - 13 mm
- Hexagon type with holding magnet
- 6.3 mm (1/4") hexagon drill shaft
- length: 100 mm



Item #	Description
2759	Socket Set, Hexagon, extra long 6.3 mm (1/4") Drive for electric drills 6 - 13 mm 8 pcs.
2762	Socket, Hexagon, extra long for electric drills 6.3 mm (1/4") Drive 6 mm
2763	Socket, Hexagon, extra long for electric drills 6.3 mm (1/4") Drive 7 mm
2764	Socket, Hexagon, extra long for electric drills 6.3 mm (1/4") Drive 8 mm
2765	Socket, Hexagon, extra long for electric drills 6.3 mm (1/4") Drive 9 mm
2766	Socket, Hexagon, extra long for electric drills 6.3 mm (1/4") Drive 10 mm
2767	Socket, Hexagon, extra long for electric drills 6.3 mm (1/4") Drive 11 mm
2768	Socket, Hexagon, extra long for electric drills 6.3 mm (1/4") Drive 12 mm
2769	Socket, Hexagon, extra long for electric drills 6.3 mm (1/4") Drive 13 mm



Socket Set, Hexagon | 6.3 mm (1/4") Drive | 6 - 13 mm | 8 pcs.

6.3  1/4

- hexagon type with holding magnet
- 6.3 mm (1/4") drill shaft
- Socket hexagon, 6.3 mm (1/4") drive: 6 - 7 - 8 - 9 - 10 - 11 - 12 - 13 mm
- profile: hexagon
- drive profile size, metric: 6.3 mm
- length: 65 mm
- drive profile size, inch: 1/4"



Item #
2758



Drill Chuck | 13 mm | 4 pcs.

- with SDS adapter
- incl. Chuck Key Set



Item #
9937



Multi Purpose Drill Set | 7 pcs.

- ball bearing shaft core
- shaft core diameter 6 mm
- max. drive speed 5000 rpm
- max. torque 10 Nm
- in aluminium case
- 10 mm keyless chuck 90° angled drill attachment
- 1200 mm flexible drive shaft with 10 mm keyed chuck
- 150 mm hex drive extension, with quick release chuck
- 150 mm flexible extension
- magnetic bit holder
- countersink
- chuck key



Item #
7992

Angled Drill Head with Keyless Chuck | for Ø 0.8 - 10

- for screwdriving and drilling in hard to reach areas
- handle can be mounted on both sides for fatigue-free working
- forward and reverse action
- suitable for 0.8 to 10 mm drills
- drive shaft diameter 9.5 mm
- max. speed allowed: 500 rpm
- max. torque 30 Nm



Item #
8621



Angled Drill Head with Keyless Chuck

- extra heavy and solid type
- ideal for drilling around corners
- ball bearing shaft support
- suitable for drilling and screwing
- 8 mm hexagon shaft drive
- head height: 100 mm
- max. drive speed 5000 rpm
- max. torque 20 Nm

Item #
4847



Universal Drill Chuck Cross Key | 4 - 7 mm

- made of high-resistance steel
- suitable for most drill chucks
- dimensions 4 - 5.5 - 6 - 7 mm

Item #
8955



Brush Set | 38 pcs.

- all brushes with 6.3 mm (1/4") drive
- for cleaning and deburring cylinders, bushings, pipes, etc.
- also for use on electric and air powered drills
- 12 nylon brushes Ø 8 - 9 - 10 - 11 - 12 - 13 - 14 - 15 - 16 - 17 - 18 - 19 mm
- 12 steel brushes Ø 8 - 9 - 10 - 11 - 12 - 13 - 14 - 15 - 16 - 17 - 18 - 19 mm
- 12 solid brass brushes Ø 8 - 9 - 10 - 11 - 12 - 13 - 14 - 15 - 16 - 17 - 18 - 19 mm
- 1 handle with 6.3 mm (1/4") drive and quick lock
- 1 extension bar 150 mm

Item #
3078



Brush Set | 20 pcs.

- for polishing and cleaning machines, cars and other work pieces made of metal, plastic, wood, etc.
- drive 6.3 mm (1/4"), Ø 9 - 11 - 13 - 15 - 17 - 19 mm
- in practical nylon pouch
- 6 brass brushes
- 6 nylon brushes
- 6 stainless steel brushes
- 1 extension with quick release for power tool use, 150 mm
- 1 soft grip handle 150 mm with quick release for hand use



Item #	Description
379	Brush Set 20 pcs.
379-LEER	Empty Wallet for BGS 379

Steel Wire Brush with Plastic Handle | 282 mm

- brush dimensions: 20 x 130 mm
- steel wire, 4-rows



Item #
9316

Steel Wire Brush with Plastic Handle | 172 mm

- brush dimensions: 45 x 150 mm
- steel wire, 5-rows



Item #
9317

Steel Wire Brush with Plastic Handle | 172 mm

- brush dimensions: 25 x 160 mm
- steel wire, 4-rows



Item #
9315

Mini Brush Set | Nylon, Brass, Stainless Steel | 165 mm | 3 pcs.

- handle type: 2-component handles



Item #
9314



Wire Brushes



Item #	Description
3173	Wire Brush brass 260 mm
3172	Steel Wire Brush brass coated 260 mm
3171	Steel Wire Brush 260 mm



Handheld Brush | steel wire | 5-rows | 300 mm

- length: 300 mm
- material: cast steel



Item #
3073



Spark Plug Cleaning Brush | 140 mm

- brass wire
- length: 140 mm



Item #
3080



Wire Cup Brush | 6 mm Shaft | Ø 75 mm

- curled steel
- max. drive speed: 4,500 rpm
- diameter: 75 mm
- drill shaft diameter: 6 mm

Item #
3076



Disc Brush | Ø 100 mm

- curled
- diameter: 100 mm
- wire diameter: 0.3 mm
- drill shaft diameter: 6 mm

Item #
3077



Disc Brushes / knotted round Brushes

- for angle grinders
- hole 22,2 mm
- Steel wire



Item #	Description
3985	Disc Brush / knotted round Brush Ø 115 mm
3986	Disc Brush / knotted round Brush Ø 125 mm

Disc Brush | Drive shaft 6 mm | knotted | Ø 75 mm

- diameter: 75 mm
- drill shaft diameter: 6 mm

Item #
3982



Disc Brush | M14x2 Drive | Ø 115 mm

- 18 twisted brushes
- suitable for mounting on bench grinders
- for removal of rust, undercoating, etc.

Item #
3981



Wire Cup Brush | M14 x 2 Drive | Ø 65 mm

- knotted
- diameter: 65 mm

Item #
3980



Wire Cup Brushes | receptacle M14 x 2

- suitable for cleaning and rust removal
- material: steel
- mounting thread: M14x2



Item #	Description
3983	Wire Cup Brush M14 x 2 Drive Ø 75 mm x 57 mm
3987	Wire Cup Brush M14 x 2 Drive Ø 100 mm x 67 mm
3988	Wire Cup Brush M14 x 2 Drive Ø 125 mm x 75 mm
3993	Wire Cup Brush M14 x 2 Drive Ø 65 mm x 50 mm
3994	Wire Cup Brush M14 x 2 Drive Ø 100 mm x 67 mm



Steel Wire Brush | 20 mm

- knotted
- shaft diameter 6 mm
- Brush diameter: 20 mm
- Wire diameter 0.4 mm

Item #
8363



Steel Wire Brush | brass coated | Ø 25 mm

- curled
- Wire diameter: 0.35 mm
- surface finish: brass coated
- diameter: 28 mm
- drill shaft diameter: 6 mm

Item #
8364



Nylon Brush | 100 mm | 6 mm Shaft

- especially suitable for softer materials such as aluminium, brass, etc.
- protects surfaces from scratching
- drill shaft diameter: 6 mm
- Brush diameter: 100 mm
- Brush strength: 1.45 mm



Item #	
9186	

Wire Cup Brush | Ø 75 mm | Nylon

- especially suitable for softer materials
- such as aluminium, brass, etc.
- protects surfaces from scratching



Item #	
9187	

Cleaning Brush Set for Studs and Wheel Nut Bolts

- for the fast and easy cleaning of studs
- quick-exchange brush adaptor with 12.5 mm (1/2") drive
- Adaptor 12.5 mm (1/2") on 6.3 mm (1/4") external 6-pt for use of brushes with cordless Screwdriver
- including the following 5 brushes for the following stud sizes:
 - 12 mm (7/16")
 - 13 mm (1/2")
 - 14 mm (9/16")
 - 16 mm (5/8")
 - 22 mm (7/8")



Item #	Description
9373	Cleaning Brush Set for Studs and Wheel Nut Bolts
9373-12	Replacement Brush Head 12 mm for BGS 9373
9373-13	Replacement Brush Head 13 mm for BGS 9373
9373-14	Replacement Brush Head 14 mm for BGS 9373
9373-16	Replacement Brush Head 16 mm for BGS 9373

Letter Punch Sets | 27 pcs.

- suitable for punching letters into steel and iron according to DIN 1451
- engraving on offset surface with depth limitation
- capital letters A to Z
- symbol/characters "&"
- packed in plastic case



Item #	Description
2030	Letter Punch Set 3 mm
2031	Letter Punch Set 4 mm
2032	Letter Punch Set 5 mm
2033	Letter Punch Set 6 mm
2034	Letter Punch Set 8 mm
2035	Letter Punch Set 10 mm

Figure Punch Sets | 9 pcs.

- suitable for punching letters into steel and iron according to DIN 1451
- engraving on offset surface with depth limitation
- figures 0-9
- packed in plastic case



Item #	Description
3031	Figure Punch Set 2 mm
3028	Figure Punch Set 2.5 mm
3033	Figure Punch Set 3 mm
3034	Figure Punch Set 4 mm
3035	Figure Punch Set 5 mm
3036	Figure Punch Set 6 mm
3038	Figure Punch Set 8 mm
3039	Figure Punch Set 10 mm
3040	Figure Punch Set 12 mm

Star Punch | 6 mm

- limiter icon for chassis numbers

Item #
2050



Needle File Set | 12 pcs.

- file length 140 mm
- in plastic pouch
- different shapes: round, square, triangle, halfround, flat, etc.



Item #
50200



Diamond File Set | straight | 140 x 3 mm | 10 pcs.

- insulated handle
- various types

Item #
1920



Diamond Hole File Set | bent | 140 x 3 mm | 10 pcs.

- insulated handle
- various types

Item #
1921



Machinist's File Set | 5 pcs.

- with plastic handle
- flat file, 250 mm, H1 (coarse)
- flat file, 200 mm, H2 (medium fine)
- half-round file, 200 mm, H1 (coarse)
- triangular file, 150 mm, H2 (medium fine)
- round file, 150 mm, H1 (coarse)

Item #
8494



HSS Milling Cutter Set | 7 pcs.

- suitable for drilling and milling machines
- for grinding and shaping wood, plastic, aluminium, copper, etc.
- includes the following milling heads: 1 spherical, 2 conical, 2 cylindrical, 2 cylindrical with ball head
- material: HSS-steel
- max. drive speed: 30,000 rpm
- Drill shaft diameter: 6 mm

Item #
8626



HSS Milling Cutter Set, extra long | 4 pcs.

- suitable for milling steel, copper, cast steel, aluminum, etc.
- 1 ball milling cutter, Ø 10 mm
- 1 cone milling cutter, Ø max. 10 mm
- 1 cone milling cutter, Ø max. 12 mm
- 1 cylindrical milling cutter, Ø 10 mm
- material: HSS-steel
- speed: 10000 rpm
- drill shaft diameter: 6 mm
- shaft size: 150 mm



Item #
101

HSS Milling Cutter Set | 3 pcs.

- in metal box
- material: HSS-steel
- max. drive speed: 13000 rpm



Item #
111



Diamond-Coated Grinding and Milling Drill Bit Set | 20 pcs.

- for electric grinding tools
- diamond coated for use glass, ceramics, steel, stainless steel
- various types
- drive shaft: 3 mm



Item #
1607



Welding Spot Cutter | 70 mm

- tip manufactured from HSS steel



Item #	Description
1600	Welding Spot Cutter 70 mm
1601	HSS Spare Cutting Head for welding Spot Cutter BGS 1600

Spot Weld Drill Set | 10 pcs.

- drill milling cutter with double core cutter 9.5 mm
- cobalt HSS spot weld drill 8 x 80 mm
- 5 double ended cutter crowns 9.5 mm
- 2 pilot pins
- drive speed: 700 to 2000 rpm

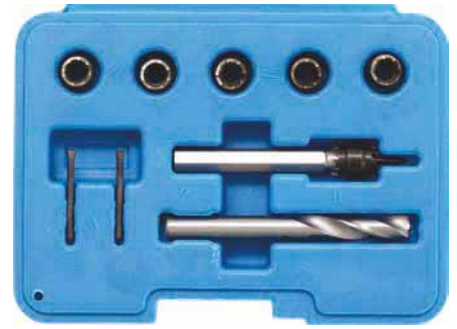

Item #
1632

Welding Spot Cutter Set | 5% Cobalt steel | 3 pcs.

- drills contained: Ø 6.5 mm, 8 mm and 10 mm
- special HSS Cobalt steel prevents dulling by overheating
- centering tip prevents a walking of the drill



Item #
5081

Tap Set | Starter, Plug, Bottoming Tap | 3 pcs.

- made of HSS-G steel
- includes starter, plug and bottoming tap



Item #	Description
930	Tap Set Starter, Plug, Bottoming Tap M3 x 0.5 3 pcs.
931	Tap Set Starter, Plug, Bottoming Tap M4 x 0.7 3 pcs.
932	Tap Set Starter, Plug, Bottoming Tap M5 x 0.8 3 pcs.
933	Tap Set Starter, Plug, Bottoming Tap M6 x 1.0 3 pcs.
934	Tap Set Starter, Plug, Bottoming Tap M8 x 1.25 3 pcs.
935	Tap Set Starter, Plug, Bottoming Tap M10 x 1.5 3 pcs.
936	Tap Set Starter, Plug, Bottoming Tap M12 x 1.75 3 pcs.



Tap Set | Pre & finish Cutter | 2 pcs.

- made from carbon steel (GCr 15) / chrome steel (100 Cr6)
- includes starter and plug tap

Item #	Description
1900-M6X1.0-B	Tap Set Starter & Plug Tap M6 x 1.0 2 pcs.
1900-M8X1.0-B	Tap Set Starter & Plug Tap M8 x 1.0 2 pcs.
1900-M8X1.25-B	Tap Set Starter & Plug Tap M8 x 1.25 2 pcs.
1900-M10X0.75-B	Tap Set Starter & Plug Tap M10 x 0.75 2 pcs.
1900-M10X1.0-B	Tap Set Starter & Plug Tap M10 x 1.0 2 pcs.
1900-M10X1.25-B	Tap Set Starter & Plug Tap M10 x 1.25 2 pcs.
1900-M10X1.5-B	Tap Set Starter & Plug Tap M10 x 1.5 2 pcs.
1900-M11X0.75-B	Tap Set Starter & Plug Tap M11 x 0.75 2 pcs.
1900-M11X1.0-B	Tap Set Starter & Plug Tap M11 x 1.0 2 pcs.
1900-M11X1.25-B	Tap Set Starter & Plug Tap M11 x 1.25 2 pcs.
1900-M12X0.75-B	Tap Set Starter & Plug Tap M12 x 0.75 2 pcs.
1900-M12X1.0-B	Tap Set Pre & finish Cutter M12 x 1.0 2 pcs.
1900-M12X1.25-B	Tap Set Starter & Plug Tap M12 x 1.25 2 pcs.
1900-M12X1.5-B	Tap Set Starter & Plug Tap M12 x 1.5 2 pcs.
1900-M12X1.75-B	Tap Set Starter & Plug Tap M12 x 1.75 2 pcs.
1900-M14X1.0-B	Tap Set Starter & Plug Tap M14 x 1.0 2 pcs.
1900-M14X1.25-B	Tap Set Starter & Plug Tap M14 x 1.25 2 pcs.
1900-M14X1.5-B	Tap Set Starter & Plug Tap M14 x 1.5 2 pcs.



Thread Cutters

Threading Die

- made from carbon steel (GCr15) / chrome steel (100 Cr6)

Item #	Description
1900-M8X1.25-S	Threading Die M8 x 1.25 x 25 mm
1900-M10X1.25-S	Threading Die M10 x 1.25 x 25 mm
1900-M10X1.5-S	Threading Die M10 x 1.5 x 25 mm
1900-M12X1.25-S	Threading Die M12 x 1.25 x 38 mm
1900-M12X1.5-S	Threading Die M12 x 1.5 x 38 mm
1900-M14X1.25-S	Threading Die M14 x 1.25 x 38 mm
1900-M14X1.5-S	Threading Die M14 x 1.5 x 38 mm
1900-M18X1.5-S	Threading Die M18 x 1.5 x 38 mm



Thread File | internal and external screw Threads | Metric 0.80 - 3.00 mm

- suitable for metric pitch: 0.80 - 1.00 - 1.25 - 1.50 - 1.75 - 2.00 - 2.50 - 3.00

Item #
1922



Thread File | internal and external screw Threads | SAE 10" - 24"

- in SAE (inch sizes), steps: 10" - 11" - 12" - 14" - 16" - 18" - 20" - 24"

Item #
1923



Thread File | for internal and external screw Threads | Whitworth 10 - 24

- Whitworth sizes: 10 - 11 - 12 - 14 - 16 - 18 - 20 - 24

Item #
1929



Thread Repair Kit

- HSS-G-tap
- HSS-G-twist
- special installation tool
- tang breaker
- thread insert



Item #	Description
1952	Thread Repair Kit M5 x 0.8 29 pcs.
1959-1	Replacement Thread Inserts M5 x 0.8 25 pcs.
1953	Thread Repair Kit M6 x 1.0 29 pcs.
1959-2	Replacement Thread Inserts M6 x 1.0 25 pcs.
9431	Thread Repair Kit M7 x 1.0 29 pcs.
9431-1	Replacement Thread Inserts M7 x 1.0 mm 25 pcs.
9427	Thread Repair Kit M8 x 1.0 29 pcs.
9427-1	Replacement Thread Inserts M8 x 1.0 mm 25 pcs.
1954	Thread Repair Set M8 x 1.25 29 pcs.
1959-3	Replacement Thread Inserts M8 x 1.25 25 pcs.
9435	Thread Repair Kit M9 x 1.25 29 pcs.
9435-1	Replacement Thread Inserts M9 x 1.25 mm 25 pcs.
1958	Thread Repair Kit M10 x 1.0 14 pcs.
1958-1	Replacement Thread Inserts M10 x 1.0 25 pcs.
9428	Thread Repair Kit M10 x 1.25 29 pcs.
9428-1	Replacement Thread Inserts M10 x 1.25 mm 25 pcs.
1955	Thread Repair Kit M10 x 1.5 29 pcs.
1959-4	Replacement Thread Inserts M10 x 1.5 25 pcs.
9436	Thread Repair Kit M11 x 1.5 14 pcs.
9436-1	Replacement Thread Inserts M11 x 1.5 mm 10 pcs.
9437	Thread Repair Kit M12 x 1.0 14 pcs.
9437-1	Replacement Thread Inserts M12 x 1.0 mm 10 pcs.
1959	Thread Repair Kit M12 x 1.25 14 pcs.
1959-7	Replacement Thread Inserts M12 x 1.25 10 pcs.
9429	Thread Repair Kit M12 x 1.5 14 pcs.
9429-1	Replacement Thread Inserts M12 x 1.5 mm 10 pcs.
1956	Thread Repair Kit M12 x 1.75 14 pcs.
1959-5	Replacement Thread Inserts M12 x 1.75 10 pcs.
1957	Thread Repair Kit M14 x 1.25 14 pcs.
1959-6	Replacement Thread Inserts M14 x 1.25 10 pcs.
9430	Thread Repair Kit M14 x 1.5 14 pcs.
9430-1	Replacement Thread Inserts M14 x 1.5 mm 10 pcs.
9432	Thread Repair Kit M16 x 1.5 12 pcs.
9432-1	Replacement Thread Inserts M16 x 1.5 mm 5 pcs.
9433	Thread Repair Kit M18 x 1.5 7 pcs.
9433-1	Replacement Thread Inserts M18 x 1.5 mm 5 pcs.
9434	Thread Repair Kit M20 x 1.5 7 pcs.
9434-1	Replacement Thread Inserts M20 x 1.5 mm 5 pcs.
9438	Thread Repair Kit M24 x 2.0 7 pcs.
9438-1	Replacement Thread Inserts M24 x 2.0 mm 3 pcs.



Thread Repair Kits | 130 pcs.

- 5 HSS-G-taps
 - 5 HSS-G-twist drills
 - 5 special installation tools
 - 5 tang breakers
 - 110 thread inserts
- **BGS 1950:**
each 25 pieces: M5x0.80, M6x1.00, M8x1.25, M10x1.5010
10 pieces: M12x1.75
 - **BGS 1951:**
each 25 pieces: M6x1.00, M8x1.25, M14x1.25
20 pieces: M10x1.5
15 pieces: M12x1.75



Item #	Description
1950	Thread Repair Kit M5 - M12 130 pcs.
1951	Thread Repair Kit M6 - M14 130 pcs.

Wheel Stud Repair Tool | M12 + M14

- for restoring of wheel stud threads, sizes: M12 x 1.25 - M12 x 1.5 - M14 x 1.5
- unique design allows the 2-halves of the thread restorer to be fitted on the good thread and wound back over the damaged thread, which is normally at the end of the stud
- consisting of 3 thread restoring tools and special holder



Item #
8691

Tap & Die Set for Wheel Studs & Nuts | 12 pcs.

- for thread re-cutting on wheel nuts and bolts
- special holders allow use on built-in wheel studs directly on the car
- taps: M12 x 1.25 - M12 x 1.50 - M14 x 1.50
- dies: M12 x 1.25 - M12 x 1.50 - M14 x 1.50
- 2 tap holders with square head
- 2 die holders with Ø 30 mm
- 1 internal hexagon L-type wrench
- 1 thread gauge with 12 blades for following thread pitch: 0.5 - 0.6 - 0.7 - 0.75 - 0.8 - 0.9 - 1.0 - 1.25 - 1.5 - 1.75 - NPT27 - BSP28



Item #	Description
1988	Tap & Die Set for Wheel Studs & Nuts 12 pcs.
1988-1	55 mm deep adaptor for BGS 1988

Repair Tool for Oxygen Sensor Thread | M18 x 1.5 mm | M12 x 1.25 mm | 2 pcs.

- for cleaning and recutting rusty and damaged oxygen sensor threads
- 16 mm drive
- thread cutter M18 x 1.5 mm
- thread cutter M12 x 1.25 mm
- length: 51 mm



Item #	
65591	

Oxygen Sensor Thread Repair Tool | M18 x 1.5 mm

6.3 1/4

- for cleaning and recutting rusty and damaged oxygen sensor threads
- extra short design
- especially suitable for confined areas
- 10 mm (3/8") drive or external hexagon 19
- for thread/incline: M18 x 1.5



Item #	
65590	

Thread Repair Kit for Drive Shafts / Prop Shafts | 8 pcs.

- for trimming and cleaning external threads
- to be turned directly on the external hexagon without die holder
- color coding metric / inch
- tap M24 x 1.50 mm - 13/16" x 20 UNEF
- tap M24 x 2.00 mm - 3/4" x 20 UNEF
- tap M22 x 1.00 mm
- tap M22 x 1.50 mm
- tap M20 x 1.50 mm
- tap M20 x 1.25 mm

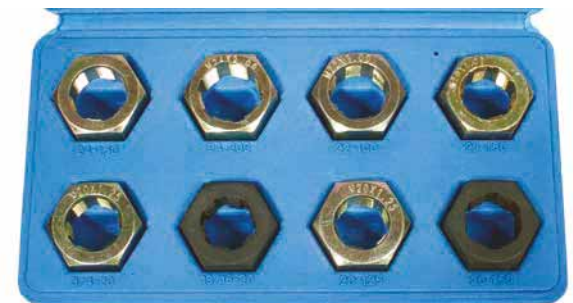

Item #	Description
1141	Thread Repair Kit for Drive Shafts / Prop Shafts 8 pcs.
1141-LEER	Empty Case for BGS 1141

Repair Kit for Oxygen Sensor Thread

- for repair of defective oxygen sensor threads
- a renewing of exhaust pipes etc. is not required
- reamer Ø 18.6 mm, for reaming of oxygen sensor threads
- tap M20 x 1.5, for cutting the repair bushing threads
- tap M18 x 1.5, for cutting of oxygen sensor threads
- insertion tool to insert the threaded bushings
- 5 repair bushings



Item #	Description
66215	Repair Kit for Oxygen Sensor Thread
66215-1	Thread Replacers for Oxygen Sensor Repair Kit M18 x 1.5 mm

Tool Tray 1/6: Thread Repair Kit | for Injector Fastening Screws | 10 pcs.

- suitable for Mercedes-Benz CDI engines
- for reaming the broken-off expansion bolt & repairing the M6 thread in the cylinder head
- time saving as the replacement of the cylinder head and the removal of injectors and valve covers is not necessary
- damaged thread is reworked to size M8 x 1
- 1 twist drill 6 mm, with adjusting ring for drilled depth
- 1 step drill 7 to 8 mm, with adjusting ring for drilled depth
- 1 guide sleeve for 6 mm twist drill
- 1 tap M8 x 1
- 1 assembly tool for threaded inserts
- 5 threaded inserts, inner thread M6 x 1 / outer thread M8 x 1



Item #		1 / 6
9538		

Tap and Die Set | M6 - M24 | 45 pcs.

- 20 taps for internal threads and 20 dies for external threads (one each size)
M6 x 0.75 - M8 x 1.0 - M6 x 1.0 - M8 x 1.25 - M10 x 1.25 - M10 x 1.50 - M12 x 1.50 - M14 x 1.50 - M16 x 1.50 - M18 x 1.50 - M20 x 1.50 - M22 x 1.50 - M24 x 1.50 - M12 x 1.75 - M14 x 2.0 - M16 x 2.0 - M18 x 2.5 - M20 x 2.5 - M22 x 2.5 - M24 x 3.0
- 1 adjustable tap wrench
- 1 tap holder
- 1 die holder
- 1 adaptor for die holder
- 1 Screwdriver, slot drive 6 mm
- material: GCr15
- in a plastic case



Item #	Description
1893	Tap and Die Set M6 - M24 45 pcs.
1893-LEER	Empty Case for BGS 1893

Tap and Die Set | Tin-Coated | M6 - M24 | 45-tlg.

- 20 taps for internal threads, 20 dies for external threads (one each size):
M6 x 0,75 - M8 x 1,00 - M6 x 1,00 - M8 x 1,25 - M10 x 1,25 - M10 x 1,5 - M12 x 1,5 - M14 x 1,5 - M16 x 1,5 - M18 x 1,5 - M20 x 1,5 - M22 x 1,5 - M24 x 1,5 - M12 x 1,75 - M14 x 2,0 - M16 x 2,0 - M18 x 2,5 - M20 x 2,5 - M22 x 2,5 - M24 x 3,0
- 1 adjustable tap wrench
- 1 die holder
- 1 tap holder
- 1 adaptor for die holder
- 1 screwdriver, slot drive 6 mm
- Material: GCr15
- surface finish: titanium-nitrided
- in a plastic case

Item #
1899



Tap and Die Set | Inch Sizes | 1/4" - 1" | 45 pcs.

- imperial sizes
- 20 taps for internal threads and 20 dies for external threads (one each size):
 - fine threads: 1/4" NF28 - 5/16" NF24 - 3/8" NF24 - 7/16" NF20 - 1/2" NF20 - 9/16" NF18 - 5/8" NF18 - 3/4" NF16 - 7/8" NF14 - 1" NF14
 - rough threads: 1/4" NC20 - 5/16" NC18 - 3/8" NC16 - 7/16" NC14 - 1/2" NC13 - 9/16" NC12 - 5/8" NC11 - 3/4" NC10 - 7/8" NC9 - 1" NC8
- 1 adjustable tap wrench
- 1 die holder
- 1 tap holder
- 1 adaptor for die holder
- 1 screwdriver, slot drive 6 mm
- material: GCr15
- in a plastic case

Item #
1898

1/4" 3/8" 1/2"



Tap and Die Set | M2 - M18 | 110 pcs.

- especially for fine threads
- 2 die holders
- 2 tap holders
- 1 T-holder for taps
- 35 taps (starter and plug tap for each size) and dies in following sizes
 M2 x 0.4 - M3 x 0.5 - M4 x 0.7 - M5 x 0.8 - M6 x 1.0 - M6 x 0.75 - M7 x 1.0 - M7 x 0.75 - M8 x 0.75 - M8 x 1.0 - M8 x 1.25 - M9 x 0.75 - M9 x 1.0 - M9 x 1.25 - M10 x 0.75 - M10 x 1.0 - M10 x 1.25 - M10 x 1.5 - M11 x 0.75 - M11 x 1.0 - M11 x 1.25 - M11 x 1.5 - M12 x 0.75 - M12 x 1.0 - M12 x 1.25 - M12 x 1.5 - M12 x 1.75 - M14 x 1.0 - M14 x 1.25 - M14 x 1.5 - M14 x 2.0 - M16 x 1.0 - M16 x 1.5 - M16 x 2.0 - M18 x 1.5
- material: GCr15
- in a plastic case



Item #	Description
1900	Tap and Die Set M2 - M18 110 pcs.
1900-LEER	Empty Case for BGS 1900

Tap and Die Set | Metric / Inch Sizes | 110 pcs.

- especially for fine threads
- 2 die holders
- 2 tap holders
- 1 T-holder for taps
- 35 taps (starter and plug tap for each size) and dies in following sizes
 4"-40UNC - 6"-32UNC - 8"-32UNC - 10"-24UNC - 10"-32UNF - 12"-24UNC - 1/4"-20UNC - 1/4"-28UNF - 1/4"-24UNS - 1/4"-32UNS - 5/16"-18UNC - 5/16"-24UNF - 3/8"-16UNC - 3/8"-24UNF - 7/16"-14UNC - 7/16"-20UNF - 1/2"-13UNC - 1/2"-20UNF - 9/16"-12UNC - 9/16"-18UNF - 5/8"-11UNC - 5/8"-18UNF - 3/4"-10UNC - 3/4"-16UNF - M6 x 1.0 - M8 x 1.25 - M10 x 1.5 - M10 x 1.0 - M11 x 1.5 - M12 x 1.25 - M12 x 1.75 - M14 x 1.25 - M18 x 1.5 - 1/8"-27NP - 1/4"-18NPT
- material: GCr15
- in a plastic case



Item #	
900	1/4" 3/8" 1/2"

Thread Cutters

Tap and Die Set | M3 - M12 | 44 pcs.

- 7 tap sizes (DIN 352), each size includes starter, plug and bottoming tap
M3 x 0.5 - M4 x 0.7 - M5 x 0.8 - M6 x 1.0 - M8 x 1.25 - M10 x 1.5 - M12 x 1.75
- 7 dies (DIN 223)
M3 x 0.5 (Ø 20 x 5 mm) - M4 x 0.7 (Ø 20 x 5 mm) - M5 x 0.8 (Ø 20 x 7 mm) - M6 x 1.0 (Ø 20 x 7 mm) - M8 x 1.25 (Ø 25 x 9 mm) - M10 x 1.5 (Ø 30 x 11 mm) - M12 x 1.75 (Ø 38 x 14 mm)
- 5 die holders: No. 1 - 2 - 3 - 4 - 5
#1 = M3 - M4
#2 = M5 - M6
#3 = M8
#4 = M10
#5 = M12
- 2 tap wrenches (DIN 1814): No. 1 - 2
#1 = M1 - M10
#2 = M4 - M12
- 7 HSS drills (DIN 338) 2.5 - 3.3 - 4.2 - 5 - 6 - 8 - 8.5 - 10.2 mm
- 1 screwpitch gauge
- 1 screwdriver
- material: HSS g steel
- in a metal case



Item #
1927

Tap and Die Set | M3 - M12 | 32 pcs.

- 7 tap sets DIN 352
- 7 dies DIN 223
25 x 9 mm: M3 x 0.5 - M4 x 0.7 - M5 x 0.8 - M6 x 1.0 - M8 x 1.25 - M10 x 1.5 - M12 x 1.75
- 1 die holder 25 x 9 mm
- 1 tap wrench (DIN 1814) no. 1
- 1 screwpitch gauge
- 1 screwdriver
- material: HSS g steel
- in a metal case



Item #
1925

Tap and Die Set | M3 - M12 | 32 pcs.

- 7 tap sets DIN 352
- 7 dies DIN 223
25 x 9 mm: M3 x 0.5 - M4 x 0.7 - M5 x 0.8 - M6 x 1.0 - M8 x 1.25 - M10 x 1.5 - M12 x 1.75
- 1 die holder 25 x 9 mm
- 1 tap wrench (DIN 1814) no. 1
- 1 screwpitch gauge
- 1 screwdriver
- material: GCr15
- in a metal case

Item #
901



Thread Cutting Set | M3 - M12 | 21 pcs.

- DIN 352
- in metal case
- each 3 taps: M3 x 0.5 - M4 x 0.7 - M5 x 0.8 - M6 x 1.0 - M8 x 1.25 - M10 x 1.5 - M12 x 1.75
- material: HSS-steel

Item #
1924



Twist Drill / Tap Set | 14 pcs.

- twist drills: Ø 2.5 - 3.3 - 4.2 - 5.0 - 6.8 - 8.5 - 10.2 mm
- twist drills manufactured in accordance with DIN 338: M3 - M4 - M5 - M6 - M8 - M10 - M12, taps manufactured in accordance with DIN 371/376 B

Item #
9296



Thread cutting/HSS Drill Set | M3 - M12 / 2.5 - 10.2 mm

- for cutting internal metric threads
- in metal case
- drill sizes: M3 x 0.5 - M4 x 0.7 - M5 x 0.8 - M6 x 1.0M - 8 x 1.25 - M10 x 1.5 - M12 x 1.75
- 7 HSS drills for drilling the exact tapping drill hole: 2.5 - 3.3 - 4.2 - 5.0 - 6.8 - 8.5 - 10.2 mm



Item #	Description
1987	Thread cutting/HSS Drill Set M3 - M12 / 2.5 - 10.2 mm
1987-1	Tap Wrench for BGS 1987

HSS-G Drill / Tap and Die Set | 7 pcs

- 1 magnetic bit-holder
- 6 combination drills M3 x 0.5 - M4 x 0.7 - M5 x 0.8 - M6 x 1.0 M8 x 1.25 - M10 x 1.5
- multiple applications in one operation: 1. drilling the core hole 2. cutting threads - 3. flash removal and sinking



Item #	Description
1926	HSS-G Drill / Tap and Die Set 7 pcs
1926-LEER	Metal empty Case for BGS 1926

Die Holder

- Holder for Threading Dies
- steel handles, detachable
- retaining head from die-cast zinc with
- fixing screws for fastening the cutting die

Item #	Description
940	Die Holder #1 20 x 5 mm
941	Die Holder #2 20 x 7 mm
942	Die Holder #3 25 x 9 mm
943	Die Holder #4 30 x 11 mm
944	Die Holder #5 38 x 14 mm
1893-2	Die Holder #6 50 x 15 mm



Die Holder

- also as replacement for die holder in tap and die set BGS 1900

Item #	Description
1900-3	Die Holder #3 25 x 10 mm
1900-4	Die Holder #5 38 x 13 mm



Tap Wrenches

- holder for thread taps
- steel handles, detachable
- housing made of die-cast zinc
- jaws made of steel

Item #	Description
945	Tap Wrench #1 M1 - M10
946	Tap Wrench #2 M4 - M12
1893-1	Tap Wrench #3 M6 - M25



Tap Wrench

- also as replacement for tap wrench in BGS 1900

Item #	Description
1900-1	Tap Wrench M3 - M12
1900-2	Tap Wrench M6 - M20



Ratcheting Tool Holder

- for taps
- left and right side ratchet function, reversible
- works with sliding bar, 17 mm socket or 10 mm (3/8") ratchet
- suitable for taps up to M12 or 1/2"

Item #	Image
8652	 



Tool Holder with Sliding Handle for Taps

- clockwise and anti-clockwise, reversible



Item #	Description
1980	Tool Holder with Sliding Handle for Taps M3 - M10 80 mm
1981	Tool Holder with Sliding Handle for Taps M5 - M12 110 mm
1982	Tool Holder with Sliding Handle for Taps M3 - M10 255 mm
1983	Tool Holder with Sliding Handle for Taps M5 - M12 320 mm



Ratcheting Tap and Die Holder Set | 6 pcs.

- comfortable working with 10 mm (3/8") drive ratchet handle
- 72 teeth t-handle ratchet
- 2 tap holders, for sizes: M3 - M8 and M6 - M12
- 2 die holders for max. diameters of 20 mm - 25 mm
- extended range of application by using optional extension bar
- including double open end wrench



Item #	Description
1984	Ratcheting Tap and Die Holder Set 6 pcs.
1984-1	Ratchet with T-Handle external square 10 mm (3/8")

Screwpitch Gauges

Item #	Description
3067	Screwpitch Gauge 24 Blades Metric 0.25 - 6.00 mm
3068	Screwpitch Gauge 28 Blades whitworth 4G - 62G
3069	Twin Screwpitch Gauge, 52 Blades Metric 0.25 - 6.0 mm, Whitworth 4G - 62G



Face Pin Wrench Set | adjustable | Ø 2.5 - 9 mm

- face pin wrench, length: 245 mm
- carbon steel, hardened, zinc-plated
- with 8 exchangeable pins - only one wrench needed for all standard pins
- pin diameters: 2.5 - 3 - 4 - 5 - 6 - 7 - 8 - 9 mm
- max. opening width 102 mm

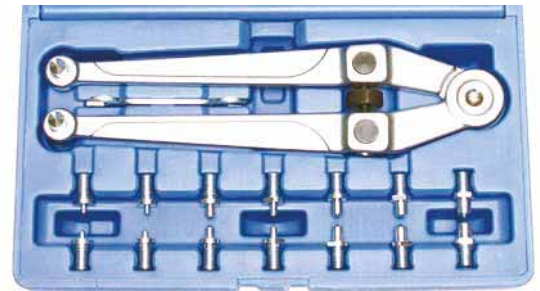

Item #	Description
1464	Face Pin Wrench Set adjustable Ø 2.5 - 9 mm
1464-4	Pin Pair Ø 4 mm for BGS 1464
1464-5	Pin Pair Ø 5 mm for BGS 1464

Hook Wrench with flexible Jaw

- for slotted/grooved nuts (DIN 1804) and for adjusting stirring head bearings
- jaw width: 35 - 60 mm
- length: 175 mm
- material: special steel
- surface finish: burnished



Item #	
1226	

Face Pin Wrench | adjustable | 180 mm

- range: 11 mm and up
- arm length 172 mm (center joint - center pin)
- offset front end 11 mm
- pin Ø 4 mm
- riveted pins



Item #	
1463	 

Seal Removing Hook Set | 3 pcs.

- S-shaped hooks e. g. for loosening rotary shaft seals
- 90° hooks e. g. for loosening O-rings
- small hook tool

Item #
8405



Fibreglass Shaft Stoning Hammer

- black lacquered head
- fibreglass shaft
- according to DIN 6475

Item #	Description
3847	Fibreglass Shaft Stoning Hammer 1000 g
3848	Fibreglass Shaft Stoning Hammer 1250 g
3849	Fibreglass Shaft Stoning Hammer 1500 g
3846	Fibreglass Shaft Stoning Hammer 2000 g



Stoning Hammer with Wooden Handle | 1000 g

- wooden shaft, 1/3 black lacquered
- satin black painted head
- gold lacquered shaft protection sleeve
- material handle: wood
- head weight: 1000 g
- Din standard: 6475

Item #
3865



Rubber Mallet with Fibreglass Shaft

Item #	Description
1960	Rubber Mallet with Fibreglass Shaft 250 g
1961	Rubber Mallet with Fibreglass Shaft 500 g
1962	Rubber Mallet with Fibreglass Shaft 750 g
1963	Rubber Mallet with Fibreglass Shaft 1200 g



Rubber Mallet | white Head

- with fibreglass handle
- made from white natural rubber, avoids marking off



Item #	Description
1965	Rubber Mallet white Head Ø 48 mm 250 g
1967	Rubber Mallet white Head Ø 64 mm 750 g



Rubber Mallet | Hickory Handle | black/white Head Ø 63 mm

- length: 340 mm
- material handle: hickory
- weight: 840 g

Item #
1969



Dead Blow Hammer | Head Ø 50 mm

- steel tube shaft
- rubber coated handle
- length: 330 mm
- weight: 850 g

Item #
1863



Dead Blow Hammer | Head Ø 60 mm

- made of polyurethane - fibre glass
- all rubber coated
- blow-back proof due to steel balls in the head of the mallet, therefore stronger impact
- especially for loosening stuck rims when changing tires
- handle length: 380 mm
- weight 1,300 g

Item #
1868



Dead Blow Hammer

- blow-back proof due to steel balls in the head of the mallet, therefore stronger impact
- especially for loosening stuck rims when changing tires

- BGS 1968: for cars
- BGS 1876: extra heavy duty for trucks and SUVs

Item #	Description
1968	Dead Blow Hammer Head Ø 70 mm
1876	Dead Blow Hammer Head Ø 105 mm



Copper Hammers

- copper hammers for damage-free assembling of bearings
- fibreglass shaft with rubber grip

Item #	Description
890	Copper Hammer 454 g (1 lb) Head
891	Copper Hammer 680 g (1.5 lb) Head
892	Copper Hammer 907 g (2 lb) Head



Machinist's Hammer

- wooden shaft, 1/3 black painted
- matt black painted head
- gold coloured shaft protection sleeve
- according to DIN 1041

Item #	Description
850	Machinist's Hammer 100 g
851	Machinist's Hammer 200 g
852	Machinist's Hammer 300 g
853	Machinist's Hammer 400 g
854	Machinist's Hammer 500 g
855	Machinist's Hammer 800 g
856	Machinist's Hammer 1000 g
857	Machinist's Hammer 1500 g
858	Machinist's Hammer 2000 g



Machinist's Hammer | fibreglass shaft

- black lacquered head
- according to DIN 1041

Item #	Description
3850	Machinist's Hammer fibreglass shaft 100 g
3852	Machinist's Hammer fibreglass shaft 300 g
3854	Machinist's Hammer fibreglass shaft 500 g
3855	Machinist's Hammer fibreglass shaft 800 g
3856	Machinist's Hammer fibreglass shaft 1000 g
3857	Machinist's Hammer fibreglass shaft 1500 g
3858	Machinist's Hammer fibreglass shaft 2000 g



Machinist's Hammers | Hickory Handle | DIN 1041

- high quality hammer for perfect working safety
- shock-resistant hickory handle
- protection metal sleeve, safety pin
- round ring wedge
- forged hammer head
- manufactured in accordance with DIN 1041

Item #	Description
52302	Machinist's Hammer Hickory Handle DIN 1041 200 g
52303	Machinist's Hammer Hickory Handle DIN 1041 300 g
52304	Machinist's Hammer Hickory Handle DIN 1041 400 g
52305	Machinist's Hammer Hickory Handle DIN 1041 500 g
52308	Machinist's Hammer Hickory Handle DIN 1041 800 g
52310	Machinist's Hammer Hickory Handle DIN 1041 1000 g
52315	Machinist's Hammer Hickory Handle DIN 1041 1500 g
52320	Machinist's Hammer Hickory Handle DIN 1041 2000 g



Roofing Hammer | Fibre Glass | 600 g

- with fibreglass handle
- forged, polished head
- magnetic inlay
- polished head
- head weight: 600 g

Item #
1865



Sledge Hammer | 5000 g

- wedged and cast head
- satin black lacquered finish
- non-slip rubber coated shaft
- length: 900 mm
- head weight: 5000 g

Item #
3860



Panel Beating Hammer | Ø 30 mm Head

- plastic heads
- 2-component-handles (fibreglass)
- head diameter: 30 mm

Item #
52326



Soft Head Hammer Set | Hickory Handles | 2 pcs.

- with nylon faces
- size head 1 Ø 30 mm
- size head 2 Ø 45 mm

Item #
1859



Hammer with Interchangeable Heads | Ø 35 mm

- 5 exchangeable heads, diameter approx. 35 mm,
- made of copper, aluminium, plastic, nylon, steel
- hickory handle
- length: 305 mm

Item #
9176



Pin Punch Set | 150 mm | incl. Chisel + Centre Punch | 8 pcs.

- in tetron wallet
- 5 pin punches with hexagon shaft, hardened, length 150 mm: 3 - 4 - 5 - 6 - 8 mm
- 1 flat chisel, length: 150 mm x 15 mm
- 1 cross chisel, length: 150 mm x 4 mm
- 1 centre punch, length: 150 mm

Item #
1658



Centre Punch Set | 6 pcs.

- hardened, tips polished, shaft lacquered
- sizes 3 - 4 - 5 - 6 - 7 - 8 mm
- length: 150 mm

Item #
1656



Automatic Centre Punch | 15 - 25 kg

- continuously adjustable 15 - 25 kg



Item #	Description
2085	Automatic Centre Punch 15 - 25 kg
2085-1	Spare Steel Tip for BGS 2085



Center Punch | 5 x 12 x 120 mm

- hardened
- lacquered 12 mm hexagon shaft
- size: 5 mm
- length: 120 mm

Item #
1696



Scriber, Hard Metal Tip | 150 mm

Item #
3131



Chisel and Punch Set | 15 pcs.

- ergonomically shaped non-slip rubber coated handle
- quick change handle manufactured from chrome molybdenum steel
- 7 flat cold chisels
- 1 cross cut chisel
- 1 center punch
- 3 centre punches
- 2 parallel pin punches



Item #
1641

Chisel and Punch Set | 28 pcs.

- in tetron wallet
- 5 pin punches made of chrome vanadium
 - 2.4 x 110 mm
 - 3.2 x 120 mm
 - 4 x 125 mm
 - 5 x 135 mm
 - 6.5 x 145 mm
- 5 conical pin punches made of chrome vanadium:
 - 2.4 x 135 mm
 - 3.2 x 145 mm
 - 4 x 150 mm
 - 5 x 160 mm
 - 6.5 x 170 mm
- 3 air-hardened chisels made of chrome vanadium:
 - 9.5 x 140 mm
 - 12.5 x 150 mm
 - 16 x 165 mm
- 2 center punches made of chrome vanadium:
 - 3 x 125 mm
 - 4.8 x 150 mm
- 1 depth gauge made of chrome vanadium
- 6 air-hardened chisels made of carbon steel:
 - 12.5 x 170 mm
 - 5 x 180 mm
 - 19 x 200 mm
 - 18 x 200 mm
 - 22 x 250 mm
 - 25 x 250 mm
- 4 pin punches made of carbon steel:
 - 3 x 150 mm
 - 18 x 260 mm
 - 9.5 x 125 mm
 - 9.5 x 250 mm
- 2 centre punches made from carbon steel: 145 mm and 375 mm



Item #
1650



Body Cutting Chisel Set | 3 pcs.

- with soft handle for safe and fatigue-free working
- regrindable surface
- hardened special steel
- Body cutting chisel, flat chisel with oval surface
- 15° angled body cutting chisel with oval surface
- 90° angled body cutting chisel with oval surface



Item #	Description
1690	Body Cutting Chisel Set 3 pcs.
1691	Body Cutting Chisel straight
1692	Body Cutting Chisel angled 15°
1693	Body Cutting Chisel angled 90°



Panel Chisel | 235 mm

- with rubber hand guard
- tip can be sharpened
- 26 mm wide
- extra thin material

Item #
1640



Flat Chisel | 25 x 250 mm

- hardened
- lacquered shaft
- cutting edge width: 25 mm
- shaft dimensions: 13 x 23 mm
- length: 250 mm

Item #
1698



Cross Chisel | 6 x 200 mm

- hardened
- lacquered shaft
- cutter dimensions: 6 x 8 mm
- shaft dimensions: 12 x 20 mm
- length: 200 mm

Item #
1699



Flat Chisel | 295 mm

- with wide safety insulation
- hexagon shaft, Ø 16 mm
- cutting edge width: 25 mm
- length: 295 mm

Item #
1646



Parallel Pin Punch Set | 100-150-200 mm | 1.5 - 9.5 mm | incl centre Punches | 18 pcs.

- extra long and thin
- hardened, colored shaft
- 8 pin punches, length: 200 mm, 1.5 - 2.5 - 3.0 - 4.0 - 5.0 - 6.0 - 8.0 - 9.5 mm
- 2 pin punches, length: 150 mm, 8.0 - 9.5 mm
- 7 pin punches, length: 100 mm, 1.5 - 2.5 - 3.0 - 4.0 - 5.0 - 5.5 - 6.0 mm
- 1 automatic centre punch, length: 125 mm

Item #
1695



Pin Punch Set | 200 mm | 3 - 10 mm | 6 pcs.

- with hexagon shaft, hardened
- extra long, 200 mm
- in tetron wallet
- pin punches, length: 200 mm, 3 - 4 - 5 - 6 - 8 - 10 mm

Item #
1655



Pin Punch / Chisel / Centre Punch Set | 12 pcs.

- heavy duty type with hexagon shaft
- forged carbon steel
- in storage bag with suspension eyelets
- 6 different flat chisels: 14.5 mm x 145 mm to 19 mm x 250 mm
- 3 pin punches: 4.5 x 250 - 6.5 x 180 - 8 x 250 mm
- 1 drift punch 9.7 x 200 mm
- 2 punches: 150 mm and 200 mm long

Item #
1657



Pin Punches

- handle with rubber protection
- hardened
- lacquered shaft



Item #	Description
9081	Pin Punch 225 mm 8 mm
9082	Pin Punch 240 mm 10 mm
9083	Pin Punch 260 mm 12 mm
9084	Pin Punch 275 mm 14 mm
9085	Pin Punch 290 mm 16 mm



Pin Punch Set | 150 mm | 3 - 8 mm | 6 pcs.

- hardened, colored shaft
- pin punches, length: 150 mm, 3 - 4 - 5 - 6 - 7 - 8 mm



Item #	Description
1651	Pin Punch Set 150 mm 3 - 8 mm 6 pcs.
1651-3	Pin Punch 150 mm 3 mm
1651-4	Pin Punch 150 mm 4 mm
1651-5	Pin Punch 150 mm 5 mm
1651-6	Pin Punch 150 mm 6 mm
1651-7	Pin Punch 150 mm 7 mm
1651-8	Pin Punch 150 mm 8 mm
1651-10	Pin Punch 150 mm 10 mm
1651-12	Pin Punch 150 mm 12 mm



Cutter | extra heavy duty finish | Blade width 25 mm

- metal type
- for right-handed people
- non slip rubber coated soft grip
- with automatic blade transport made of metal
- Blade locking mechanism with turning mechanism
- blade width: 25 mm



Item #	Description
50625	Cutter extra heavy duty finish Blade width 25 mm
50626	Retractable Blades 25 mm 10 pcs.



Safety Cutter

- heavy design
- safety auto retracting mechanism
- metal guide
- compartment for spare blades in handle
- incl. trapezoidal blades

Item #	
50602	



Safety Cutter

- self-retracting blade
- zinc alloy
- includes 1 trapezoid blade

Item #
50606



Snap-off Knife | Blade width 18 mm

- heavy duty finish, diecast zinc body
- blade width: 18 mm, metal guided
- silver colored, with black non-slip rubber coated soft grip
- blade width: 18 mm

Item #
7958

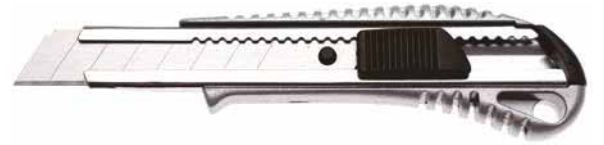

Snap-Off Knife | Blade width 18 mm

- universal knife for 18 mm break off segment blades, with metal guide
- non slip rubber coated soft grip
- 1 snap knife with inserted blade in the magazine
- 7 spare blades in plastic box
- blade width: 18 mm

Item #
7955



Universal Knife | break-off segmented Blade 18 mm

- incl. 1 break off segmented blade
- blade width: 18 mm

Item #
7980



Retractable Knife | Blade width 9 mm

- with blade locking mechanism
- made of die-cast zinc
- blade width: 9 mm, metal guided
- silver colored with black anti-slip protection
- blade width: 9 mm

Item #
7966



Spare Blade Set | 18 mm | 10 pcs.

- for universal knives BGS e. g. 7970, 7958, 7955, 7956

Item #
7971



Spare Blade Set | 9 mm | 10 pcs.

- spare blades for BGS items e. g. 7972, 7953

Item #
7973



Trapezoidal Blades Set | 0.6 x 12 mm | 5 pcs.

- heavy duty finish
- suitable for Safety Knife BGS e. g. 50606

Item #
7975



Hook Blades | 19 mm | 5 pcs.

- for cutting carpets
- blade material: SK-5
- suitable for e. g. BGS 50602, 50605, 50606, 50607

Item #
7976



Metal Shears | 300 mm

- PVC dipped handles
- spring mechanism
- with safety latch
- cutting capacity sheet steel max. 1.2 mm
- cutting capacity stainless steel max. 0.7 mm

Item #
8476



Metal Shears | left / straight cutting | 260 mm

- tooth jaw made of chrome molybdenum steel
- forged

Item #
1680



Metal Shears | right / straight cutting | 260 mm

- tooth jaw made of chrome molybdenum steel
- forged

Item #	
1681	



Metal Shears | straight cutting | extra long blades | 290 mm

- serrated edged blades, forged, induction-hardened, chrome molybdenum alloy
- special design: extra long blades, straight cut
- ergonomic 2-component handles
- for cutting sheets made of steel, copper, brass and plastic
- safety lock
- cuts up to 1.0 mm cold-rolled steel
- length: 290 mm
- blade length: 80 mm

Item #		
9450		



Mini Body Sheet Shears | straight cut | 195 mm

- for cutting sheets made of stainless steel, steel, copper, brass, etc.
- cuts up to 1.2 mm cold rolled steel or 0.7 mm AISI-304 stainless steel
- serrated edged blades, forged, induction-hardened, chrome molybdenum alloy
- 2-component handles

	
---	---

Item #	Description
6136	Mini Body Sheet Shears straight cut 195 mm
6137	Mini Body Sheet Shears left cut 195 mm
6138	Mini Body Sheet Shears right cut 195 mm



Universal Shears | Stainless Steel | 180 mm

- heavy-duty stainless steel blades
- slip guard handles with soft grips for easy use
- with spring and security lock
- saw-type blade
- with wire stripping gap

Item #	
7962	



Stainless Steel Electrician's Scissors | 145 mm

- heavy-duty stainless steel blades
- slip guard handles with soft grips for easy use
- saw-type blade
- with wire stripping gap

Item #
7963



VDE Cable Knife with Slip Protection

- VDE/GS approved according to DIN EN 60900
- up to 1000 volt
- with hanging hole
- ergonomically shaped handle with slip protection
- blade securely covered by cap
- stainless steel blade, polished

Item #
7965



Cable Knife with straight Blade

- for easy and comfortable stripping of cables
- specially shaped handle prevents slipping when pulling the knife
- stainless steel blade

Item #
9321



Cable Knife with Hook Blade

- for easy and comfortable stripping of cables
- specially shaped handle prevents slipping when pulling the knife
- stainless steel blade

Item #
9322



Folding Knife | 150 mm

- for cutting carpet, cardboard, foils, etc.
- locking mechanism for locking the knife in open position and unlocking mechanism at the back of the handle for folding the knife
- blade locking mechanism with quick release function
- incl. spare blades
- material: aluminum, anodized

Item #
50605



Knife for Insulating Material

- extra flat blade, hardened & polished
- made of rust-proof steel
- double serrated blade:
 - saw shaped side for solid and hard insulation
 - wave shaped side for soft and pliable insulation
 - blade tip for drilling into insulation materials
- length: 420 mm
- surface finish blade: polished
- blade length: 280 mm
- handle type: 2-component handle

Item #	
81728	



Knife for Insulating Material | 240 mm

- 140 mm special blade with straight edge
- for straight and clean cutting of polystyrene, EVA, fibre glass, foam- and insulation materials
- 100 mm handle, die cast zinc
- length: 240 mm
- blade length: 140 mm

Item #	
81735	



Digital Calliper | 150 mm

- extra large display
- scale in mm/inch, reading 1/100 mm
- zero reset in any position, metric/inch conversion
- +/- display
- battery included
- packed in plastic case



Item #	Description
1930	Digital Calliper 150 mm
1930-LEER	Empty Case for BGS 1930



Precision Vernier Calliper

- Chrome plated
- nonius 1/20 mm
- measurement: internal/external/depth



Item #	Description
1932	Precision Vernier Calliper 0 - 150 mm
1933	Precision Vernier Calliper 0 - 200 mm
1934	Precision Vernier Calliper 0 - 300 mm
1934-LEER	Empty Case for BGS 1934



Calliper Accessories Set

- for extending the measurement capabilities of callipers
- in wooden case

allows measurements on:

- deeper measurement points
 - inwardly tapered components
 - measuring leg, 2 pcs.
 - measuring tip, long, 2 pcs.
 - measuring tip, short, 2 pcs.
 - measuring heads, short, 2 pcs.
- calliper not included

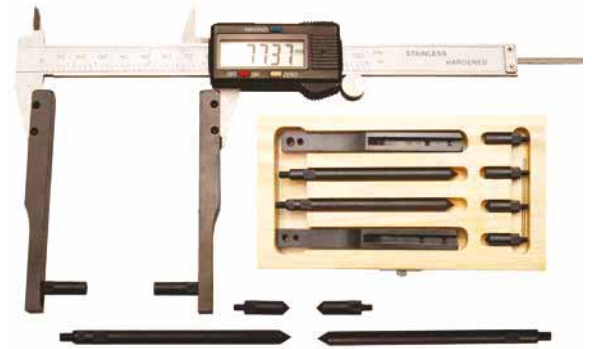

Item #
1930-1

Digital Micrometer | 0 - 25 mm

- for precise measuring of e. g. shims at gears, valves, etc.
- measuring range: 0 - 25 mm
- display resolution: 0.001 mm
- measuring resolution: +/- 4 µm
- measuring force: 5 - 10 N
- incl. CR 2032 battery



Item #
8427

Micrometer in Wooden Case | graduation 0.01 mm | 0 - 25 mm

- for precise measuring of shims at gears, valves, etc.
- measuring range: 0 - 25 mm

Item #	Description
1935	Micrometer in Wooden Case graduation 0.01 mm 0 - 25 mm
1935-LEER	Empty Wood Case for BGS 1935



Digital Micrometer | 0 - 13 mm

- for quick and easy determination of e.g. brake disc thickness, also suitable for all other measurements
- measurement is carried out via spring mechanism, opens by pressing an opening lever
- resolution: 0.01 mm

Item #
8675



Digital Protractor

- 3 tools in one: protractor, inclinometer and level
- extra large LCD display with backlight
- beeper will sound at: 0°, 10°, 20°, 30°, 40°, 50°, 60°, 70°, 80°, 90°
- stores measured data
- display automatically reads upright
- degree and slope conversion
- auto power off, low battery warning
- measuring range: 4 x 90°
- accuracy: 0.1°
- battery type: 3 V CR2032 x 3 pcs. (not included)
- operating temperature: 0°C - 40°C
- relative humidity: 40% - 80%
- length: 150 mm
- width: 50 mm
- height: 8.5 mm



Item #
9330



Digital LCD Protractor with Level | 450 mm

- for transferring and measuring angles
- HOLD-function for holding the measured value
- lighted LCD-display
- working range angle 0 to 220°
- resolution 0,1°
- angle precision +/- 0,5°
- 2 vials (horizontal and vertical)
- aluminium housing
- incl. 9V battery



Item #
50440



Aluminium Water Level | 300 mm

- bubble levels for horizontal, vertical and diagonal (45 degree) measurement



Item #
3574

Measuring Tapes

- with locking function and belt clip
- in accordance with EEC



Item #	Description
8393	Measuring Tape 16 mm x 3 m
8394	Measuring Tape 19 mm x 5 m
8392	Measuring Tape 25 mm x 8 m



Wooden Folding Rule | 2 m

- easy operation due to internal steel springs
- tight links and scale division on the 2-nd part
- black graduation, decimal numbers in red
- accuracy class III
- length: 2 m

Item #
2053



Calliper for Inch Screws

- for determining the required wrench

Item #
8644



Magnetic Stand for Measuring Instruments

- on/off switch
- Dial gauge holder for 4.5 mm and 8 mm shaft
- Magnetic block with prism support (e.g. for shafts)
- Retaining arm with fine adjustment and joint
- suitable for holding mechanical and digital dial gauges

Item #
1938



Gauge for BGS 1938

- measuring resolution +/- 0.01 mm



Item #
1938-1

Digital Dial Gauge

- switchable from inches to mm
- measuring range: 0 - 12.7 mm (1/2")
- reset button for 0-position
- automatic turn-off
- suitable for standard measuring stands for e. g. BGS 1938
- clamping Ø 8 mm, hardened and polished
- hardened ball tip



Item #
1938-2

Battery | SR44

- suitable for e. g. BGS 1930, 1941
- standard battery SR44



Item #
1931

Battery | CR2032

- suitable for e. g. BGS 977, 978, 979, 1943, 9330
- standard battery CR2032



Item #
9700

Nut Splitter | 3 - 24 mm

- for splitting rusted nuts
- suitable for 3 - 24 mm
- adjustable backing plate
- hardened splitting head



Item #
9024



Nut Splitter Set | 12 - 16 mm / 16 - 22 mm | 2 pcs.

- forged carbon steel, separates bolts and corroded/stuck nuts
- avoids damage of the thread
- nut splitter, up to 16 mm, drive 14 mm, length: 95 mm
- nut splitter, up to 22 mm, drive 19 mm, length: 120 mm

Item #
1812



Nut Splitters

- forged carbon steel, separates bolts and corroded/stuck nuts
- without damaging the thread



Item #	Description
1811	Nut Splitter up to 16 mm
1810	Nut Splitter up to 22 mm



Expert tube Cutter with Ratcheting function

- with ratcheting function
- manufactured from diecast aluminium
- hardened and stainless blades
- for plastic tube Ø up to 35 mm

Item #	Description
1819	Expert Tube Cutter with Ratcheting function
1819-1	Replacement Blade for Professional Pipe Cutter for BGS 1819



Pipe Cutter | Ø 3 - 35 mm / 1/8" - 1 3/8"

- heavy duty
- 4 bearing wheels
- fine adjustment spindle to adjust the cutting roller pressure
- suitable for aluminium, copper, steel pipes
- incl. deburring tool

Item #	Description
8341	Pipe Cutter Ø 3 - 35 mm / 1/8" - 1 3/8"
8341-1	Replacement Cutter for 8341



Pipe Cutter | Ø 4 - 28 mm

- for copper pipes
- with spring for adjusting the cutting wheel contact pressure
- Spring prevents excessive contact pressure and possible crushing of the pipe

Item #	Description
8344	Pipe Cutter Ø 4 - 28 mm
8344-1	Pipe Blade for Tube Cutter BGS 8344



Tube Cutter | Ø 3 - 25 mm / 1/8" - 1"

- heavy duty
- 2 bearing wheels
- fine adjustment spindle to adjust the cutting roller pressure
- best suitable for aluminium, copper, steel pipes



Item #	Description
8340	Tube Cutter Ø 3 - 25 mm / 1/8" - 1"
8340-1	Replacement Cutter for BGS 8340

"3-in-1" Countersink Set

- Deburring tool: Ø 12 - 16 - 19 mm
- with quick lock, non-slip ergonomic 2 component handle



Item #	Description
8369	

Deburring Tool

- blade rotates 360° in handle, thus ideally suitable for deburring holes
- length: 135 mm
- blade length: 47 mm
- handle type: 2-component handle



Item #	Description
8328	Deburring Tool
8329	Spare Blade for BGS 8328

Pipe Reamer

- for outside and inside deburring of metal pipes
- suitable for pipe internal diameter of 3 to 12 mm and pipe outside diameter of 4 to 14 mm
- inside cutter retractable
- nickel-chromium-molybdenum alloy
- outside cutter made of HSS steel



Item #	Description
8732	

Hacksaw Frame | extra heavy duty | incl. HSS saw Blade | 300 mm

- soft grip handle
- square pipe
- with HSS saw blade 300 mm

Item #
2079



Aluminium Hacksaw Frame | incl. HSS saw Blade | 300 mm

- high strength aluminium frame with low weight
- professional anti-slip handle
- highly effective blade tensioning system
- for straight cuttings
- saw blade 0° - 90° - 180° - 270° adjustable
- incl. HSS bi-metal saw blade
- length: 300 mm

Item #
2081



Hacksaw Frame | incl. HSS saw Blade | 300 mm

- saw blade adjustable in 2 positions

Item #
2077



Plastic Hacksaw | 150 mm

- black rubber handle
- incl. 1 metal saw blade

Item #
2064



Hand Tools

Aluminium Hacksaw Frame | 150 mm

- ideal for wood, metal and plastic
- pistol grip for best handling
- saw blade 0° - 60° - 120° - 180° - 240° - 300° adjustable
- incl. bi-metal saw blade
- length: 150 mm

Item #
2083



Jigsaw Frame | extra deep type

- wooden handle
- with 5 assorted blades (170 mm length)
- extra deep shape

Item #
2073



Rapid Pull Saw | 265 mm

- high carbon steel blade
- induction hardened teeth
- 15 teeth per 25.4 mm

Item #
50350



Hacksaw Blades | HSS | 13 x 300 mm | 10 pcs.

- 24 tooth per inch
- saw blade length 300 mm
- saw blade width 13 mm
- material: HSS-steel
- saw blade thickness 0.65 mm
- tooth separation: 24

Item #
2061



Hacksaw Blades | 13 x 300 mm | 2 pcs.

- length: 300 mm
- material: HSS-steel

Item #
8628

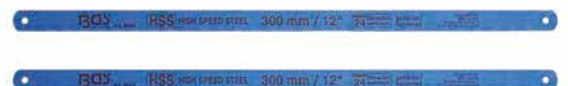

Plastic Miter Box | 245 x 67 x 48 mm

- for perfectly fitting miters
- clean and safe use of hand saws
- for 45 and 90 ° angle
- max. cutting depth 34 mm
- max. cutting width 42 mm

Item #
50855



Aluminium Miter Box | 245 x 65 x 55 mm

- for perfectly fitting miters
- clean and safe use of hand saws
- for 45° and 90° angle
- cutting depth: 45 mm
- cutting width: 60 mm

Item #
50860



Aluminium Miter Box | 245 x 106 x 44 mm

- for perfectly fitting miters
- clean and safe use of hand saws
- for 45° and 90° angle
- cutting depth: 44 mm
- cutting width: 106 mm

Item #
50865



Push-through Ratchet with Adaptor and Step Wrench | internal square 12.5 mm (1/2") 12.5 □ 1/2

- step wrench with external hexagon: 10 mm (3/8") - 7/16" - 12.5 mm (1/2") - 5/8" - 13/16"
- profile: internal square (1/2")
- 12.5 mm drive
- surface finish: chrome-plated

Item #
314



Radiator Spud Wrench | 12.5 mm (1/2") Drive | 5 steps

12.5 □ 1/2

- 3/8" - 7/16" - 1/2" - 5/8" - 13/16" mm
- suitable ratchet e. g. BGS 312

Item #
1461



Radiator Spud Wrench | 12.5 mm (1/2") Drive | 5 steps

12.5  1/2

- 3/8", 7/16", 1/2", 16 and 21 mm

Item #
1462



Installation Wrench | for WC seat

- hygienic, clean and very easy to handle
- for almost all WC seat attachments and "corner solutions"
- for 6 mm to 10 mm threaded rods
- for turning the corner valve on and off
- optimum leverage due to special joint
- length: 200 mm

Item #
9598



Installation Wrench | for WC seat | 4 pcs.

- hygienic, clean and very easy to handle
- for almost all WC seat attachments and "corner solutions"
- for 6 mm to 10 mm threaded rods
- for turning the corner valve on and off
- optimum leverage due to special joint
- with three adapters
- length: 200 mm

Item #
9599



Sanitary Cross Wrench

- suitable for sanitation work

fits on screws with:

- external square 12.5 mm (1/2") and 10 mm (3/8")
- internal hexagon 3/8", 1/2", 3/4", 1" or 10, 12, 17, 22 mm

Item #
8448

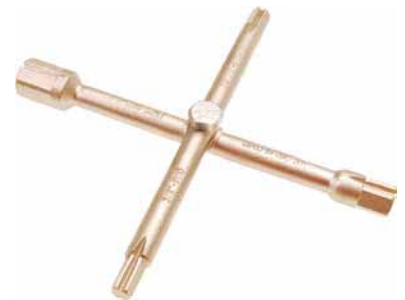

Sanitary Wrench | with Sliding part M10 | 17x19 mm

- sliding part with M10 interior thread
- wrench size 1: 17 mm
- wrench size 2: 19 mm

Item #
8560



Basin Wrench

- perfect for right and left hand threads
- foldable T-handle
- 180° swivel head
- heavy design
- max. opening: 40 mm



Item #
8330

Universal Switchboard Key

- for opening and closing technical locks of switchboards control devices, a/c, ventilation, access panels, service doors
- also for opening service doors of street lights, garbage cans etc.
- including chain, bit, adaptor and 5 mm square for heatings
- a must-have tool for industry, handcraft, town councils, energy suppliers, public services, electricians, DIY, sanitary, building, janitors and many more
- dimensions: 72x72 mm, weight 80 g



Item #
9415



Universal Key "PRO Key"

- for opening and closing technical locks of a/c, ventilation, access panels, service doors
- also for opening service doors of street lights, garbage cans etc.
- including chain, bit, adaptor and 5 mm square for heatings
- a must-have tool for industry, handcraft, town councils, energy suppliers, public services, electricians, DIY, sanitary, building, janitors and many more
- length: 90 mm
- width: 62 mm
- weight: 80 g



Item #
9416



Universal Switchboard Key "SuBMaker Quadro 10 in 1"

- suitable for industry, crafts, air conditioning and ventilation technology
- double rotating mechanism for the following tools:
 - holder for 6.3 mm (1/4") sockets, allows for comfortable operation
 - bit holder for 6.3 mm (1/4") hexagon in the rotating cross and mid section, bits are held over inserted magnet
 - internal 3-pt. 5 - 6 - 6 - 7 - 8 - 9 mm
 - internal square, 5 mm, for bleeding radiators
 - internal square 6 - 7 - 8 - 9 mm
 - special key for control cabinets, round, with two tabs, 3-5 mm
- with practical holding clip
- length: 95 mm
- width: 38 mm
- weight: 86 g



Item #
1469



Screw Hole Punch

- high alloy special steel
- for securely drilling stainless steel or similar materials
- 6-pt. drive 17 mm



Item #	Description
3902	Screw Hole Punch 32 mm
562	Screw Hole Punch 35 mm

Pipe Threading Set | 3/8" - 1.1/4" | 7 pcs.

- sizes: 3/8", 1/2", 3/4", 1", 1 1/4"
- 1 pipe threading ratchet with 2-piece extension bar



Item #
1892

Water Pump Pliers | with Plastic Protective Jaws | 250 mm

- suitable for all types of fittings
- protection jaws prevent damage to chromed surfaces
- easy adjustment mechanism
- PVC dipped handles
- incl. 2 spare protective jaws
- min. opening: 8 mm, max. opening: 68 mm
- max. clamping width: 68 mm
- min. clamping width: 8 mm



Item #
75120



Universal Scraper Set | 4 pcs.

- solid, ergonomically shaped 2-component grip handles with hanging hole and metal cap for use with hammer
- blade material: stainless steel
- 2 scrapers, 2.4 mm thick, with slightly flattened blade e.g. for removing rust:
 - blade length 94 mm x wide 31 mm
 - blade length 43 mm x wide 20 mm
- 2 scrapers, 1.1 mm thick, with a sharp blade e.g. for removing seals
 - blade length 94 mm x wide 31 mm
 - blade length 43 mm x wide 20 mm



Item #
363

Scraper & Knife Set | 27 pcs.

- incl. 20 sharp blades in various sizes
- with 5 blades for the removal of glue, labels etc.
- incl. 2 component rubber coated handle and robust universal knife

Item #	Description
364	Scraper & Knife Set 27 pcs.
364-LEER	Empty Case for BGS 364
364-12	Spare Scraper Blades Set for BGS 364 0.6 x 12 mm 5 pcs.
364-16x53	Spare Scraper Blades Set for BGS 364 0.6 x 16 mm x 53° 5 pcs.
364-16	Spare Scraper Blades Set for BGS 364 0.6 x 16 mm 5 pcs.
364-20	Spare Scraper Blades Set for BGS 364 0.6 x 20 mm 5 pcs.



Plastic Scraper

- for removing glued wheel balancing weights on aluminum wheel rims and for removing glued protective strips and trims
- blade can be sharpened



Item #	Description
367	Plastic Scraper 19 mm
365	Plastic Scraper 22 mm

Plastic Scraper Set | 19 - 22 - 25 - 38 mm wide | 4 pcs.

- ideal for the removal of glued weights on aluminium rims (motorcars and motorbikes)
- suitable for removing glued protective strips on a car's body
- blade can be sharpened
- material: polyoxymethylene (POM) / fibre glass



Item #	
366	

Scraper | Stainless Steel | solid 2-component Rubber grip Handle with hole

- blade size: 30 mm
- blade length: 105 mm
- blade thickness: approx. 2.3 mm



Item #	
3063	

Gasket Scraper | 280 mm

- for cleaning cylinder head / valve cover and carburettor or cover gaskets
- blade width: 25 mm



Item #	
3085	

Polishing Heads Assortment | 6.3 mm (1/4") Drive | 14 pcs.

- made of fine cotton
- ideal for polishing metal and non-metal workpieces
- shaft 6.3 mm (1/4")
- 6 mushroom shaped polishing heads:
 - each 2x 50 mm - 75 mm - 100 mm
 - ideal for polishing surfaces face down onto work
- 4 taper shape polishing heads:
 - each 2x 53 mm - 63 mm
 - ideal for polishing the inside of cups, domes, bowls and goblets
- 4 drum shape polishing heads:
 - each 2x 45 mm - 63 mm
 - ideal for polishing awkward areas and inside goblets and bowls



Item #
3995

Polish Sets for hard or soft Metals | 7 pcs.

- complete kit for removing scratches and for polishing metals
- available for soft and hard metals:
3990: for soft metals, e.g. brass, copper, tin, pewter, aluminium,
3991: for hard metals, e.g. steel, iron, stainless steel- with 3 buffing pads
- with 3 buffing pads (3990: 1x firm, 2x medium / 3991: 2x firm, 1x medium)
- with drill chuck
- with 3 polishing pastes



Item #	Description
3990	Polish Set for soft Metals 7 pcs.
3991	Polish Set for hard Metals 7 pcs.

Polishing Disc with Mandrel | 6 mm

- suitable for polishing materials such as copper, brass, aluminium, steel, etc.
- 6 mm shaft for electric drills
- multi-layer disc Ø 125 x 22 mm



Item #
3989



Polisher Kit | Ø 65 + 105 mm

- especially for cars and trucks for cleaning, rust removal etc.
- 12.5 mm (1/2") adaptor for air impact wrenches



Item #
3965



Flap Discs

- for angle grinders
- bore 22.2 mm

Item #	Description
3970	Flap Disc Ø 115 mm K 40
3973	Flap Disc Ø 115 mm K 60
3971	Flap Disc Ø 115 mm K 80
3972	Flap Disc Ø 115 mm K 120
3974	Flap Disc Ø 125 mm K 40
3975	Flap Disc Ø 125 mm K 60
3976	Flap Disc Ø 125 mm K 80
3977	Flap Disc Ø 125 mm K 120



Abrasive Grinding Wheel | black | Ø 100 mm | 16 mm mounting hole

- ideal for removing rust & paint
- 6 mm shank diameter
- max. drive speed 11500 rpm
- for use with an electric drill
- diameter: 100 mm
- bore diameter: 16 mm



Item #	
3978	

Abrasive Grinding Wheels | Ø 100 mm | 16 mm mounting hole

- ideal for removing rust & paint
- max. drive speed: 11,500 rpm (max. 80 m/s)
- mounting hole: Ø 16 mm
- diameter: 100 mm
- material: carborundum, grain size: 46



Item #	Description
9183	Abrasive Grinding Wheel blue Ø 100 mm 16 mm mounting hole
9184	Abrasive Grinding Wheel black Ø 100 mm 16 mm mounting hole

Grinding Wheels / Sanding Pad Set | Ø 50 mm

- for grinding of surfaces in automotive and other areas
- suitable for electric drills
- max. drive speed 30,000 rpm
- 1 x mounting plate for grinding wheels with shaft diameter 6 mm, shaft length 45 mm, thread M6 x 1/4"
- 2 x grinding discs, grain size 60 (brown)
- 2 x grinding discs, grain size 120 (brown)



Item #	
8590	

Grinding Wheels / Sanding Pad Set | Ø 75 mm

- for grinding of surfaces in automotive and other areas
- 75 mm adaptor disc with 6 mm shaft
- suitable for electric drills
- max. drive speed 10,000 rpm
- 1 grinding disc, grit 60 (brown)
- 2 grinding discs, grit 80 (red)
- 2 grinding discs, grit 120 (green)



Item #	
8591	

Grinding and Polishing Set | Ø 125 mm

- for grinding and polishing of surfaces in automotive and other areas
- 125 mm adaptor disc M14 with hook and loop support
- includes foam pad, wool pad, sanding paper (aluminum oxide), grit 400-600-800
- suitable for machines with M14 adaptor



Item #
8592



Chain Saw Sharpener

- for use with an electric drill with collar of Ø 43 mm (European Standard)
- for chains of any length
- simple operation
- includes one disc 100 x 3.2 x 10 mm (BGS 3177) for chain sizes 6.3 mm (1/4"), 0.325" and 10 mm (3/8")



Item #	Description
3180	Chain Saw Sharpener
3177	Grinding Disc for BGS 3180 Ø 100 x 3.2 x 10 mm
3178	Grinding Disc for BGS 3180 Ø 100 x 4.5 x 10 mm

Foil Eraser | Ø 90 mm

- suitable for electric drills
- for the removal of adhesive residues, etc.
- shaft size: 6 mm, length: 18 mm
- incl. adaptor 5/8" x 24 to 6.0 mm, length: 40 mm
- max. 4000 rpm
- diameter: 90 mm
- thickness: 15 mm



Item #
3999

HSS Lathe Tool Set | 38 pcs

- shaft thickness: 8 mm (5/16")
- carbide tipped
- various shapes
- length 60 mm each



Item #
9925

Cutting Disc for Metal / Stone | Type 42

- MPA certified
- cranked type, suitable for angle grinders
- bore 22.2 mm
- disc thickness: 2.5 mm
- max. speed: 80 m/s

- 3922
- suitable for steel
 - max. drive speed: 13.300 rpm
 - disc diameter: 115 mm

- 3923
- suitable for steel
 - max. drive speed: 12.200 rpm
 - disc diameter: 125 mm

- 3927
- suitable for stone
 - max. drive speed: 13.300 rpm
 - disc diameter: 115 mm



Item #	Description
3922	Cutting Disc for Metal Ø 115 x 2.5 x 22.2 mm Type 42
3927	Cutting Disc for Stone Ø 115 x 2.5 x 22.2 mm Type 42

Cutting Discs for Stainless Steel

- perfect for cutting stainless steel
- 1 mm thickness for fine cuts (3935, 3936)
- 22.2 mm reinforced bore hole
- max. 13,280 rpm, 80 m/s

Item #	Description
3935	Cutting Discs for Stainless Steel Ø 115 x 1.0 x 22.2 mm 5 pcs.
3936	Cutting Discs for Stainless Steel Ø 125 x 1.0 x 22.2 mm 5 pcs.
3937	Cutting Discs for Stainless Steel Ø 230 x 1.6 x 22.2 mm 5 pcs.



Screwdriver Set | extra long | Cross Slot PH / Slot SL | 2 pcs.

- screwdriver, slot SL 6 mm
- screwdriver, cross slot PH2
- length: 450 mm

Item #	
730	



Screwdriver Set | 5 pcs.

- non-slip 2-component handles
- screwdriver slot SL 4.0 x 80 mm - 5.5 x 125 mm - 6.5 x 150 mm
- screwdriver cross slot PH1 x 80 mm - PH2 x 100 mm



Item #
7943



Screwdriver Set | 7 pcs.

- non-slip 2-component handles
- screwdriver slot SL: 4 x 80 mm - 5.5 x 125 mm - 6.5 x 150 mm - 8.0 x 200 mm
- screwdriver cross slot PH: PH1 x 80 mm - PH2 x 100 mm - PH3 x 150 mm



Item #
7944



Screwdriver Set | internal Hexagon | 8 pcs.

- non-slip 2-component handles
- screwdriver internal hexagon 1.5 x 75 mm - 2.0 x 75 mm - 2.5 x 75 mm - 3.0 x 100 mm - 4.0 x 100 mm - 5.0 x 150 mm - 6.0 x 150 mm - 8.0 x 200 mm



Item #
8629



Screwdriver Set | Spline (for XZN) | 5 pcs.

- screwdriver for spline screws: M4 - M5 - M6 - M8 - M10
- with non-slip 2 component handles
- blade length: 300 mm
- length: 400 mm



Item #
7924



Screwdriver Set | 12 pcs.

- end-to-end blades with external hexagon
- ergonomically shaped „soft grip" handle
- screwdriver slot SL: 3.2 x 72 mm - 5.0 x 75 mm - 6.0 x 100 mm - 6.0 x 38 mm - 8.0 x 150 mm - 9.5 x 200 mm
- screwdriver cross slot: PH0 x 75 mm - PH1 x 75 mm - PH2 x 100 mm - PH2 x 38 mm - PH3 x 150 mm - PH4 x 200 mm



Item #	Description
7895	Screwdriver Set 12 pcs.
7895-LEER	Empty Case for BGS 7895

T-Handle Screwdriver and Socket Set | 19 pcs.

- 2-way handle
- bit adaptor
- bit holder
- 8 double ended bit blades, length: 175 mm
 - inner hexagon with and without ball point 3 - 4 - 5 - 6 mm
 - inner hexagon with ball point, 7 mm + internal hexagon 1/4"
 - slot 4.5 + 6.5 mm
 - T-Star (for Torx) T25 + T27 - T30 + T40
- 8 socket blades, hex: 5 - 6 - 7 - 8 - 10 - 11 - 12 - 13 mm



Item #	Description
7985	T-Handle Screwdriver and Socket Set 19 pcs.
7985-LEER	Empty Case for BGS 7985
7985-25X27	Spare Blade T25 x T27

VDE Screwdriver Set | 2 pcs.

- VDE approved according to DIN EN 60900
- 1 VDE screwdriver cross slot: PH2
- 1 VDE screwdriver slot SL: 4 mm
- 2-component anti-slip handles
- length: 100 mm



Item #
35812



VDE Screwdriver Set | 8 pcs.

- 2-component anti-slip handle
- with suspension hole
- VDE approved according to DIN EN 60900
- screwdriver slot SL: 0.5 x 3.0 x 75 mm - 0.8 x 4.0 x 100 mm - 1.0 x 5.5 x 125 mm - 1.2 x 6.5 x 150 mm
- screwdriver cross slot: PH0 x 75 mm - PH1 x 80 mm - PH2 x 100 mm
- voltage tester: 0.5 x 3.0 x 140 mm



Manual Impact Wrench with Bits | 5 pcs.

- robust quality
- incl. 2 cross slot (PH2 - PH3) and 2 slot SL bits (8 - 10 mm)
- in metal case
- surface finish: satin chrome plated



Bits for Impact Wrench | for BGS 710

- suitable for hand impact wrench BGS 710
- external hexagon drive: 8 mm (5/16")
- 2 slot SL 8 - 10 mm
- 2 cross slot PH2 - PH3
- length: 36 mm



Precision Screwdriver Set | T-Star (for Torx) | 7 pcs.

- use wherever precise work is required like e.g. in model making, electronics etc.
- blade length: 50 mm
- precision screwdriver T-Star (for Torx): T6 x 50 mm - T7 x 50 mm - T8 x 50 mm - T9 x 50 mm - T10 x 50 mm - T15 x 50 mm - T20 x 50 mm



Tool Set | 6.3 mm (1/4") + 12.5 mm (1/2") | E-Type / T-Star (for Torx) | 84 pcs. 6.3 1/4 12.5 1/2

- 6 bits, length 30 mm, 10 mm shaft, T-Star tamperproof (for Torx): T40 - T45 - T50 - T55 - T60 - T70
- 7 bits, length 75 mm, 10 mm shaft, T-Star (for Torx): T15 - T20 - T25 - T30 - T40 - T45 - T50
- 2 bits, length 75 mm, 14 mm shaft, T-Star (for Torx): T55 - T60
- 3 bits, length 40 mm, 14 mm shaft, T-Star tamperproof (for Torx): T80 - T90 - T100
- 12 hexagon wrenches, T-Star (for Torx): T8 - T10 - T15 - T20 - T25 - T27 - T30 - T40 - T45 - T50 - T55 - T60
- 8 screwdrivers, T-Star tamperproof (for Torx): T8 - T10 - T15 - T20 - T25 - T27 - T30 - T40
- 4 double ring spanners, E-type: E6xE8 - E10xE12 - E14xE18 - E20xE24
- 1 magnetic pick up tool

6,3 mm (1/4") drive:

- 7 sockets, E-type: E4 - E5 - E6 - E7 - E8 - E10 - E11
- 6 bit sockets, length: 37 mm, T-Star (for Torx): T10 - T15 - T20 - T25 - T27 - T30
- 3 bits, length: 25 mm, T-Star (for Torx): T7 - T8 - T9
- 8 bits, length: 25 mm, in plastic holder, TS-Star tamperproof (for Torx): T10 - T15 - T20 - T25 - T27 - T30 - T40 - T45
- 7 bits, T-Star tamperproof (for Torx): T10 - T15 - T20 - T25 - T27 - T30 - T40
- 1 bit adapter 6.3 mm (1/4") for 6.3 mm (1/4") bits

12,5 mm (1/2") drive:

- 7 sockets, E-type: E12 - E14 - E16 - E18 - E20 - E22 - E24
- 1 bit adapter 12.5 mm (1/2") for 10 mm bits
- 1 bit adapter 12.5 mm (1/2") for 14 mm bits



Item #	
7849	

Screwdriver Set | T-Star (for Torx) T10 - T40 | 7 pcs.

- non-slip 2 component handle
- screwdriver, length: 80 mm, T-Star (for Torx): T10
- screwdriver, length: 80 mm, T-Star (for Torx): T15
- screwdriver, length: 80 mm, T-Star (for Torx): T20
- screwdriver, length: 100 mm, T-Star (for Torx): T25
- screwdriver, length: 100 mm, T-Star (for Torx): T27
- screwdriver, length: 100 mm, T-Star (for Torx): T30
- screwdriver, length: 150 mm, T-Star (for Torx): T40



Item #	
7846	

Screwdriver Set | T-Star tamperproof (for Torx) | T10 - T40 | 7 pcs.

- anti-slip 2-component handle
- screwdriver, length: 80 mm, T-Star tamperproof (for Torx): T10
- screwdriver, length: 80 mm, T-Star tamperproof (for Torx): T15
- screwdriver, length: 80 mm, T-Star tamperproof (for Torx): T20
- screwdriver, length: 100 mm, T-Star tamperproof (for Torx): T25
- screwdriver, length: 100 mm, T-Star tamperproof (for Torx): T27
- screwdriver, length: 100 mm, T-Star tamperproof (for Torx): T30
- screwdriver, length: 150 mm, T-Star tamperproof (for Torx): T40



Item #
7841



Screwdriver Set, extra long | T-Star (for Torx) T15 - T30 | 4 pcs.

- anti-slip 2-component handle
- screwdriver, T-Star (for Torx): T15 - T20 - T25 - T30
- blade length: 250 mm
- length: 355 mm



Item #
4943



Screwdriver Set with interchangeable Blades | T-Star (for Torx) / TS-Star (for Torx Plus) | 8 pcs.

- double ended blades with TS-/T-star (for Torx) in each of the following sizes: 10 - 15 - 20 - 25 - 27 - 30 - 40
- all blades with tamperproof heads
- one handle fits all sizes
- anti-slip 2-component handle
- length: 300 mm



Item #
2325



Special Screwdriver Set | T-Star (for Torx) | internal Hexagon | 4 pcs.

- interchangeable double ended blades
- specially for adjusting wiper nozzles
- 2-way holder
- 6 mm internal hexagon
- 7 mm internal hexagon
- T25 (especially for VW Sharan)
- length: 300 mm



Item #
7840



Screwdrivers | internal Hexagon

- 2-component anti-slip handle
- chrome plated
- with black finished tips



Item #	Description
8629-1	Screwdriver internal Hexagon 1.5 mm Blade Length 75 mm
8629-2	Screwdriver internal Hexagon 2 mm Blade Length 75 mm
8629-3	Screwdriver internal Hexagon 2.5 mm Blade Length 75 mm
8629-4	Screwdriver internal Hexagon 3 mm Blade Length 100 mm
8629-5	Screwdriver internal Hexagon 4 mm Blade Length 100 mm
8629-6	Screwdriver internal Hexagon 5 mm Blade Length 150 mm
8629-7	Screwdriver internal Hexagon 6 mm Blade Length 150 mm
8629-8	Screwdriver internal Hexagon 8 mm Blade Length 200 mm



Screwdrivers | Cross Slot PH

- rubber handle
- chrome plated
- with black finished tips



Item #	Description
7934	Screwdriver Cross Slot PH1 Blade Length 80 mm
7935	Screwdriver Cross Slot PH2 Blade Length 100 mm



Screwdrivers | Cross Slot PH

- 2-component anti-slip handle
- with 6.3 mm (1/4") square drive in handle
- large sizes have metal caps
- chrome plated
- with black finished tips



Item #	Description
4907	Screwdriver Cross Slot PH0 Blade Length 100 mm
4908	Screwdriver Cross Slot PH1 Blade Length 75 mm
4909	Screwdriver Cross Slot PH2 Blade Length 38 mm
4910	Screwdriver Cross Slot PH2 Blade Length 100 mm
4911	Screwdriver Cross Slot PH3 Blade Length 150 mm
4912	Screwdriver Cross Slot PH4 Blade Length 200 mm



Screwdrivers | Cross Slot PH

- 2-component anti-slip handle
- black screwdriver tip



Item #	Description
4935	Screwdriver Cross Slot PH1 Blade Length 80 mm
4936	Screwdriver Cross Slot PH2 Blade Length 100 mm
4937	Screwdriver Cross Slot PH3 Blade Length 150 mm



Screwdrivers | Cross Slot PH

- end-to-end blades with external hexagon
- ergonomically shaped "soft grip" handle



Item #	Description
7910	Screwdriver Cross Slot PH0 Blade Length 75 mm
7911	Screwdriver, Blade with Hexagon profile Cross Slot PH1 Blade Length 75 mm
7912	Screwdriver, Blade with Hexagon profile Cross Slot PH2 Blade Length 38 mm
7913	Screwdriver, Blade with Hexagon profile Cross Slot PH2 Blade Length 100 mm
7914	Screwdriver, Blade with Hexagon profile Cross Slot PH3 Blade Length 150 mm
7915	Screwdriver, Blade with Hexagon profile Cross Slot PH4 Blade Length 200 mm



VDE Screwdrivers | Slot PH

- 2-component anti-slip handle
- with hanging holes
- VDE/GS approved



Item #	Description
4942	VDE Screwdriver Cross Slot PH0 Blade Length 75 mm
4926	VDE Screwdriver Cross Slot PH1 Blade Length 80 mm
4927	VDE Screwdriver Cross Slot PH2 Blade Length 100 mm



Screwdriver, long | Cross Slot PH2 | Blade Length 450 mm

- cross Slot PH2

Item #	CV
732	



Screwdrivers | Cross Slot PZ

- with black finished tips
- rubber handle, black
- surface finish: chrome plated



Item #	Description		
7936	Screwdriver	Cross Slot PZ1	Blade Length 80 mm
7937	Screwdriver	Cross Slot PZ2	Blade Length 100 mm



Screwdrivers | Cross Slot PZ

- with black finished tips
- 2-component anti-slip handle



Item #	Description		
4932	Screwdriver	Cross Slot PZ1	Blade Length 75 mm
4933	Screwdriver	Cross Slot PZ2	Blade Length 100 mm
4934	Screwdriver	Cross Slot PZ3	Blade Length 150 mm



Screwdrivers | Slot SL

- chrome plated
- with black finished tips
- rubber handles, black



Item #	Description		
7931	Screwdriver	Slot SL 4 mm	Blade Length 80 mm
7932	Screwdriver	Slot SL 5.5 mm	Blade Length 125 mm
7933	Screwdriver	Slot SL 6.5 mm	Blade Length 150 mm



Screwdrivers | Slot SL

- 2-component anti-slip handle
- with 6.3 mm (1/4") inner square in handle
- large sizes have metal caps (BGS 4902, 4903, 4904, 4905, 4906)



Item #	Description
4901	Screwdriver Slot SL 3 mm Blade Length 100 mm
4902	Screwdriver Slot SL 5 mm Blade Length 75 mm
4903	Screwdriver Slot SL 6 mm Blade Length 38 mm
4904	Screwdriver Slot SL 6 mm Blade Length 100 mm
4905	Screwdriver Slot SL 8 mm Blade Length 150 mm
4906	Screwdriver Slot SL 10 mm Blade Length 200 mm



Screwdrivers | Slot SL

- 2-component anti-slip handles
- black screwdriver tip



Item #	Description
4928	Screwdriver Slot SL 3 mm Blade Length 60 mm
4929	Screwdriver Slot SL 4 mm Blade Length 80 mm
4930	Screwdriver Slot SL 5.5 mm Blade Length 125 mm
4931	Screwdriver Slot SL 6.5 mm Blade Length 150 mm



Screwdrivers | with external Hexagon | Slot SL

- end-to-end blades with external hexagon
- ergonomically shaped "soft grip" handle



Item #	Description
7916	Screwdriver with external Hexagon Slot SL 3.2 mm Blade Length 75 mm
7917	Screwdriver with external Hexagon Slot SL 5 mm Blade Length 75 mm
7918	Screwdriver with external Hexagon Slot SL 6 mm Blade Length 38 mm
7919	Screwdriver with external Hexagon Slot SL 6 mm Blade Length 100 mm
7920	Screwdriver with external Hexagon Slot SL 8 mm Blade Length 150 mm
7921	Screwdriver with external Hexagon Slot SL 9.5 mm Blade Length 200 mm



VDE Screwdrivers | Slot SL

- 2-component anti-slip handle
- with hanging holes
- VDE/GS approved



Item #	Description
4925	VDE Screwdriver Slot SL 3 mm Blade Length 75 mm
4924	VDE Screwdriver Slot SL 4 mm Blade Length 100 mm
4940	VDE Screwdriver Slot SL 5.5 mm Blade Length 125 mm
4941	VDE Screwdriver Slot SL 6.5 mm Blade Length 150 mm

Screwdriver, long | Slot SL 6 mm | Blade Length 450 mm

- slot SL 6 mm

Item #
731



Screwdrivers | T-Star (for Torx)

- 2-component anti-slip handle



Item #	Description
4913	Screwdriver T-Star (for Torx) T6 Blade Length 80 mm
4914	Screwdriver T-Star (for Torx) T7 Blade Length 80 mm
4915	Screwdriver T-Star (for Torx) T8 Blade Length 80 mm
4916	Screwdriver T-Star (for Torx) T9 Blade Length 80 mm
4917	Screwdriver T-Star (for Torx) T10 Blade Length 80 mm
4918	Screwdriver T-Star (for Torx) T15 Blade Length 80 mm
4919	Screwdriver T-Star (for Torx) T20 Blade Length 80 mm
4920	Screwdriver T-Star (for Torx) T25 Blade Length 100 mm
4921	Screwdriver T-Star (for Torx) T27 Blade Length 100 mm
4922	Screwdriver T-Star (for Torx) T30 Blade Length 100 mm
4923	Screwdriver T-Star (for Torx) T40 Blade Length 150 mm



Screwdrivers | T-Star (for Torx)

- extra long
- 2-component anti-slip handle
- satin chrome plated



Item #	Description
4944	Screwdriver T-Star (for Torx) T15 Blade Length 250 mm
4945	Screwdriver T-Star (for Torx) T20 Blade Length 250 mm
4946	Screwdriver T-Star (for Torx) T25 Blade Length 250 mm
4947	Screwdriver T-Star (for Torx) T30 Blade Length 250 mm



Screwdrivers | T-Star tamperproof (for Torx)

- black finished tips
- 2-component anti-slip handle



Item #	Description
7849-T8	Screwdriver T-Star tamperproof (for Torx) T8 Blade Length 80 mm
7849-T10	Screwdriver T-Star tamperproof (for Torx) T10 Blade Length 80 mm
7849-T15	Screwdriver T-Star tamperproof (for Torx) T15 Blade Length 80 mm
7849-T20	Screwdriver T-Star tamperproof (for Torx) T20 Blade Length 80 mm
7849-T25	Screwdriver T-Star tamperproof (for Torx) T25 Blade Length 100 mm
7849-T27	Screwdriver T-Star tamperproof (for Torx) T27 Blade Length 100 mm
7849-T30	Screwdriver T-Star tamperproof (for Torx) T30 Blade Length 100 mm
7849-T40	Screwdriver T-Star tamperproof (for Torx) T40 Blade Length 150 mm



Screwdrivers

Precision Screwdriver and Hook Set | 12 pcs.

- 2-component anti-slip handle
- screwdriver, slot SL: 2.5 - 3.5 mm
- screwdriver, cross slot PH: PH0 - PH00
- screwdriver T-Star (for Torx): TX6 - TX7 - TX8 - TX10
- hooks: 45° - 90° - 135° - 180°
- length: 170 mm

Item #
8833



Precision Screwdriver Set | for Electronic Technicians | 11 pcs.

- in case with automatic folding function
- 2-component anti-slip handle
- 70 mm extension bar with hexagon shaft
- bits T-Star (for Torx): T4 - T5 - T6 - T7
- bits slot SL: 1,5 - 2.0 - 2.5 mm
- bits cross slot PH: PH00 - PH0 - PH1
- bits with 4 mm hexagon, shaft colour coded



Item #	CV 
8452	

Precision Screwdriver Set | 6 pcs.

- phosphated tips
- 2-component anti-slip handle
- screwdriver, slot SL: 2 - 3 - 4 mm
- screwdriver, cross slot PH: PH00 - PH0 - PH1
- length: 75 mm
- surface finish: satin chrome plated



Item #	CV 
9151	

Angled Bit Driver | 480 mm

- bit is moved by turning the handle
- head with 6.3 mm (1/4") bit holder
- with clip-on handle



Item #
4838

Carburetor Screwdriver | 360 mm

- for adjusting e. g. Pierburg carburetors
- regulating idle speed and mixture in BMW, Daimler-Benz, Ford, Peugeot and Renault cars



Item #
8017

Offset Impact Driver | 12.5 mm (1/2") | 620 mm

12.5  1/2

- suitable for different applications, e. g. loosening of the belt pulley holding screw and countershaft
- provides high loosening torque under narrow space conditions
- special slip guard safety handle



Item #	
25150	

Special Screwdriver Set | 2 pcs.

- special profile for loosening cross and slotted screws with damaged heads
- with metal striking cap
- hexagon shaft
- length: 195 mm

Item #		
7952		



Crowfoot Spanner Set | 10 mm (3/8") Drive | 10 - 19 mm | 10 pcs.

10  3/8

- supplied on metal rail
- crowfoot spanner: 10 - 11 - 12 - 13 - 14 - 15 - 16 - 17 - 18 - 19
- surface finish: chrome plated



Item #	Description
1756	Crowfoot Spanner Set 10 mm (3/8") Drive 10 - 19 mm 10 pcs.
1756-10	Crowfoot Spanner 10 mm (3/8") Drive 10 mm
1756-11	Crowfoot Spanner 10 mm (3/8") Drive 11 mm
1756-12	Crowfoot Spanner 10 mm (3/8") Drive 12 mm
1756-13	Crowfoot Spanner 10 mm (3/8") Drive 13 mm
1756-14	Crowfoot Spanner 10 mm (3/8") Drive 14 mm
1756-15	Crowfoot Spanner 10 mm (3/8") Drive 15 mm
1756-16	Crowfoot Spanner 10 mm (3/8") Drive 16 mm
1756-17	Crowfoot Spanner 10 mm (3/8") Drive 17 mm
1756-18	Crowfoot Spanner 10 mm (3/8") Drive 18 mm
1756-19	Crowfoot Spanner 10 mm (3/8") Drive 19 mm



Crowfoot Spanner Set | 12.5 mm (1/2") drive | 20 - 32 mm | 13 pcs.

12.5 \square 1/2

- sizes: 20 - 21 - 22 - 23 - 24 - 25 - 26 - 27 - 28 - 30 - 32 mm
- 1 extension bar 125 mm
- 1 flexible handle 385 mm
- surface finish: satin chrome plated



Item #	Description
1757	Crowfoot Spanner Set 12.5 mm (1/2") Drive 20 - 32 mm 13 pcs.
1757-LEER	Empty Case for BGS 1757
1757-20	Crowfoot Spanner 12.5 mm (1/2") Drive 20 mm
1757-21	Crowfoot Spanner 12.5 mm (1/2") Drive 21 mm
1757-22	Crowfoot Spanner 12.5 mm (1/2") Drive 22 mm
1757-23	Crowfoot Spanner 12.5 mm (1/2") Drive 23 mm
1757-24	Crowfoot Spanner 12.5 mm (1/2") Drive 24 mm
1757-25	Crowfoot Spanner 12.5 mm (1/2") Drive 25 mm
1757-26	Crowfoot Spanner 12.5 mm (1/2") Drive 26 mm
1757-27	Crowfoot Spanner 12.5 mm (1/2") Drive 27 mm
1757-28	Crowfoot Spanner 12.5 mm (1/2") Drive 28 mm
1757-30	Crowfoot Spanner 12.5 mm (1/2") Drive 30 mm
1757-32	Crowfoot Spanner 12.5 mm (1/2") Drive 32 mm



Crowfoot Spanner Set | 12.5 mm (1/2") / 20 mm (3/4") | 8 pcs.

12.5 \square 1/2 20 \square 3/4

- crowfoot spanners 12.5 mm (1/2") drive: 33 - 36 mm
- crowfoot spanners 20 mm (3/4") drive: 38 - 41 - 46 - 50 mm
- extension bar 12.5 mm (1/2")
- extension bar 20 mm (3/4")
- surface finish: satin chrome plated



Item #	Description
1759	Crowfoot Spanner Set 12.5 mm (1/2") / 20 mm (3/4") 8 pcs.
1759-33	Crowfoot Spanner 12,5 mm (1/2") Drive 33 mm
1759-36	Crowfoot Spanner 12.5 mm (1/2") Drive 36 mm
1759-38	Crowfoot Spanner 20 mm (3/4") Drive 38 mm
1759-41	Crowfoot Spanner 20 mm (3/4") Drive 41 mm
1759-46	Crowfoot Spanner 20 mm (3/4") Drive 46 mm
1759-50	Crowfoot Spanner 20 mm (3/4") Drive 50 mm



Combination Spanner Set | Stubby Type | 4 - 10 mm | 8 pcs.

- hot forged
- ring end 20° offset
- ring end profile: hexagon
- especially suitable for small spaces
- surface finish: chrome plated
- combination spanner: open end size 3.2 mm / ring size: 4 mm
- combination spanner: open end size 4 mm / ring size: 5 mm
- combination spanner: open end size 5 mm / ring size: 5.5 mm
- combination spanner: open end size 5.5 mm / ring size: 6 mm
- combination spanner: open end size 6 mm / ring size: 7 mm
- combination spanner: open end size 7 mm / ring size: 8 mm
- combination spanner: open end size 8 mm / ring size: 9 mm
- combination spanner: open end size 9 mm / ring size: 10 mm



Combination Spanner Set | Inch Sizes | 3/8" - 11/16" | 6 pcs.

- hot forged
- chrome plated, polished jaws
- ring end 15° angled
- profile ring end: 12-point
- packed in an easy-to-use holder
- combination spanner 3/8" - 7/16" - 1/2" - 9/16" - 5/8" - 11/16"



Combination Spanner Set | 8 - 19 mm | 8 pcs.

- DIN 3113-A
- hot forged
- chrome plated, polished jaws
- ring end 15° angled
- profile ring end: 12-point
- combination spanner 8 - 9 - 10 - 12 - 13 - 14 - 17 - 19 mm



Combination Spanner Set | 6 - 19 mm | 8 pcs.

- hot forged
- chrome plated, polished jaws
- ring end 15° angled
- profile ring end: 12-point
- packed in a tetron wallet
- combination spanner 6 - 8 - 10 - 11 - 13 - 14 - 17 - 19 mm



Combination Spanner Set | 6 - 22 mm | 12 pcs.

- DIN 3113-A
- hot forged
- polished jaws
- ring end 15° angled
- profile ring end: 12-point
- combination spanner 6 - 7 - 8 - 9 - 10 - 11 - 12 - 13 - 14 - 17 - 19 - 22 mm
- surface finish: chrome plated



Item #	CV
1194	

Combination Spanner Set | 6 - 22 mm | 12 pcs.

- DIN 3113-A
- hot forged
- chrome plated, polished jaws
- ring end 15° angled
- profile ring end: 12-point
- packed in a tetron wallet
- combination spanner 6 - 7 - 8 - 9 - 10 - 11 - 12 - 13 - 14 - 17 - 19 - 22 mm



Item #	CV
1197	

Combination Spanner Set | 6 - 22 mm | 12 pcs.

- DIN 3113-A
- hot forged
- chrome plated, polished jaws
- ring end 15° angled
- profile ring end: 12-point
- in a plastic wall-holder
- combination spanner 6 - 7 - 8 - 9 - 10 - 11 - 12 - 13 - 14 - 17 - 19 - 22 mm



Item #	CV	
1211		

Combination Spanner Set | Inch Sizes | 1/4" - 15/16" | 12 pcs.

- hot forged
- chrome plated, polished jaws
- ring end 15° angled
- profile ring end: 12-point
- packed in a tetron wallet
- combination spanner 1/4" - 5/16" - 3/8" - 7/16" - 1/2" - 9/16" - 5/8" - 11/16" - 3/4" - 13/16" - 7/8" - 15/16"



Item #	CV	
1195		

Combination Spanner Set | 6 - 32 mm | 25 pcs.

- DIN 3113-A
- hot forged
- chrome plated, polished jaws
- ring end 15° angled
- profile ring end: 12-point
- combination spanner 6 - 7 - 8 - 9 - 10 - 11 - 12 - 13 - 14 - 15 - 16 - 17 - 18 - 19 - 20 - 21 - 22 - 23 - 24 - 25 - 26 - 27 - 28 - 30 - 32 mm



Item #
1190



Combination Spanner Set | 6 - 32 mm | 25 pcs.

- DIN 3113-A
- hot forged
- chrome plated, polished jaws
- ring end 15° angled
- profile ring end: 12-point
- packed in a tetron wallet
- combination spanner 6 - 7 - 8 - 9 - 10 - 11 - 12 - 13 - 14 - 15 - 16 - 17 - 18 - 19 - 20 - 21 - 22 - 23 - 24 - 25 - 26 - 27 - 28 - 30 - 32 mm



Item #	Description
1196	Combination Spanner Set 6 - 32 mm 25 pcs.
1196-LEER	Empty Tetron Bag for BGS 1196

Combination Spanner Set | extra short | Inch Sizes | 3/8" - 7/8" | 8 pcs.

- cold forged
- matt chrome plated
- ring end 15° angled
- profile ring end: 12-point
- extra short
- packed in a tetron wallet
- combination spanner 3/8" - 7/16" - 1/2" - 9/16" - 5/8" - 11/16" - 3/4" - 7/8"



Item #
32140

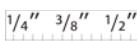

Combination Spanner Set | extra short | 10 - 19 mm | 10 pcs.

- cold forged
- satin chrome plated
- ring end 15° angled
- profile ring end: 12-point
- extra short
- packed in a tetron wallet
- combination spanner 10 - 11 - 12 - 13 - 14 - 15 - 16 - 17 - 18 - 19 mm

Item #	CV
1188	



Combination Spanner Set | 6 - 22 mm | 12 pcs.

- DIN 3113-A
- cold forged
- matt chrome plated
- ring end 15° angled
- profile ring end: 12-point
- packed in a tetron wallet
- combination spanner 6 - 7 - 8 - 9 - 10 - 11 - 12 - 13 - 14 - 17 - 19 - 22 mm

Item #	CV
30501	



Combination Spanner Set | offset | 6 - 22 mm | 12 pcs.

- DIN 3113-B
- cold forged
- matt chrome plated
- deep offset ring end
- profile ring end: 12-point
- packed in a tetron wallet
- combination spanner 6 - 7 - 8 - 9 - 10 - 11 - 12 - 13 - 14 - 17 - 19 - 22 mm

Item #	CV
30301	



Combination Spanner Set | offset | 8 - 27 mm | 17 pcs.

- cold forged
- matt chrome plated
- deep offset ring end
- profile ring end: 12-point
- packed in a tetron wallet
- combination spanner 8 - 9 - 10 - 11 - 12 - 13 - 14 - 15 - 16 - 17 - 18 - 19 - 20 - 21 - 22 - 24 - 27 mm

Item #	CV
30302	



Combination Spanner Set | Inch Sizes | 1/8" - 9/16" Withworth | 8 pcs.

- hot forged
- chrome plated and mirror polished
- ring end 15° angled
- profile ring end: 12-point
- especially for UK vintage cars and tractors
- packed in a tetron wallet
- combination spanner 1/8" WW
- combination spanner 3/16" WW
- combination spanner 6,3 mm (1/4") WW
- combination spanner 5/16" WW
- combination spanner 10 mm (3/8") WW
- combination spanner 7/16" WW
- combination spanner 12.5 mm (1/2") WW
- combination spanner 9/16" WW



Item #
1199



Combination Spanner Set | 8 - 32 mm | 19 pcs.

- DIN 3113-A
- cold forged
- matt chrome plated
- ring end 15° angled
- profile ring end: 12-point
- packed in a tetron wallet
- combination spanner 8 - 9 - 10 - 11 - 12 - 13 - 14 - 15 - 16 - 17 - 18 - 19 - 20 - 21 - 22 - 24 - 27 - 30 - 32 mm



Item #
30500



Combination Spanner Set | 8 - 32 mm | 19 pcs.

- DIN 3113-A
- cold forged
- satin chrome plated
- ring end 15° angled
- profile ring end: 12-point
- packed in a tetron wallet
- combination spanner 8 - 9 - 10 - 11 - 12 - 13 - 14 - 15 - 16 - 17 - 18 - 19 - 20 - 21 - 22 - 24 - 27 - 30 - 32 mm



Item #	Description
1219	Combination Spanner Set 8 - 32 mm 19 pcs.
1219-LEER	Empty Wallet for BGS 1219

Combination Spanner Set | 6 - 32 mm | 25 pcs.

- DIN 3113-A
- cold forged
- matt chrome plated
- ring end 15° angled
- profile ring end: 12-point
- in display box
- combination spanner 6 - 7 - 8 - 9 - 10 - 11 - 12 - 13 - 14 - 15 - 16 - 17 - 18 - 19 - 20 - 21 - 22 - 23 - 24 - 25 - 26 - 27 - 28 - 30 - 32 mm



Item #	CV
30100	

Combination Spanner Set | Inch Sizes | 1/4" - 1.1/4" | 25 pcs.

- cold forged
- matt chrome plated
- ring end 15° angled
- profile ring end: 12-point
- in display box
- combination spanner 1/4" - 9/32" - 5/16" - 11/32" - 3/8" - 7/16" - 15/32" - 1/2" - 9/16" - 19/32" - 5/8" - 11/16" - 23/32" - 3/4" - 25/32" - 13/16" - 7/8" - 29/32" - 15/16" - 1" - 1.1/32" - 1.1/16" - 1.1/8" - 1.3/16" - 1.1/4"



Item #	CV	
30101		

Combination Spanner Set | Inch Sizes | 1/4" - 1.1/4" | 25 pcs.

- cold forged
- satin chrome plated
- ring head 15° angled
- profile ring side: 12-point
- packed in a tetron wallet
- combination spanner 1/4" - 9/32" - 5/16" - 11/32" - 3/8" - 7/16" - 15/32" - 1/2" - 9/16" - 19/32" - 5/8" - 11/16" - 23/32" - 3/4" - 25/32" - 13/16" - 7/8" - 29/32" - 15/16" - 1" - 1.1/32" - 1.1/16" - 1.1/8" - 1.3/16" - 1.1/4"



Item #	CV	
9473		

Combination Spanner Set | 6 - 32 mm | 25 pcs.

- DIN 3113-A
- cold forged
- chrome plated and mirror polished
- ring end 15° angled
- profile ring end: 12-point
- packed in a tetron wallet
- combination spanner 6 - 7 - 8 - 9 - 10 - 11 - 12 - 13 - 14 - 15 - 16 - 17 - 18 - 19 - 20 - 21 - 22 - 23 - 24 - 25 - 26 - 27 - 28 - 30 - 32 mm



Item #
9290



Combination Spanner Set | extra long | 6 - 19 mm | 14 pcs.

- cold forged
- chrome plated and mirror polished
- ring end 15° angled
- profile ring end: 12-point
- extra long
- packed in a tetron wallet
- combination spanner, length: 125 mm, 6 mm
- combination spanner, length: 135 mm, 7 mm
- combination spanner, length: 145 mm, 8 mm
- combination spanner, length: 155 mm, 9 mm
- combination spanner, length: 170 mm, 10 mm
- combination spanner, length: 180 mm, 11 mm
- combination spanner, length: 195 mm, 12 mm
- combination spanner, length: 205 mm, 13 mm
- combination spanner, length: 220 mm, 14 mm
- combination spanner, length: 230 mm, 15 mm
- combination spanner, length: 240 mm, 16 mm
- combination spanner, length: 255 mm, 17 mm
- combination spanner, length: 265 mm, 18 mm
- combination spanner, length: 280 mm, 19 mm



Item #	Description
1228	Combination Spanner Set extra long 6 - 19 mm 14 pcs.
1228-LEER	Empty Tetron Bag for BGS 1228

Combination Spanner Set | extra long | 21 - 32 mm | 6 pcs.

- cold forged
- chrome plated and mirror polished
- ring end 15° angled
- profile ring end: 12-point
- extra long
- packed in a tetron wallet
- combination spanner, length: 300 mm, 21 mm
- combination spanner, length: 310 mm, 22 mm
- combination spanner, length: 335 mm, 24 mm
- combination spanner, length: 355 mm, 27 mm
- combination spanner, length: 420 mm, 30 mm
- combination spanner, length: 435 mm, 32 mm



Item #	Description
1229	Combination Spanner Set extra long 21 - 32 mm 6 pcs.
1229-LEER	Empty Tetron Bag for BGS 1229

Combination Spanner Set | extra long | 34 - 50 mm | 6 pcs.

- cold forged
- satin chrome plated
- ring end 15° angled
- profile ring end: 12-point
- in plastic holder
- combination spanner 34 mm, length: 380 mm
- combination spanner 36 mm, length: 400 mm
- combination spanner 38 mm, length: 400 mm
- combination spanner 41 mm, length: 440 mm
- combination spanner 46 mm, length: 480 mm
- combination spanner 50 mm, length: 530 mm



Item #	Description
32400	Combination Spanner Set extra long 34 - 50 mm 6 pcs.
32400-LEER	Empty Case for BGS 32400

Combination Spanner Assortment | Inch / Metric Sizes | 50 pcs.

- cold forged
- satin chrome plated
- profile ring end: 12-point
- packed in a tetron wallet
- 20 combination spanners:
 - 10 - 11 - 12 - 13 - 14 - 15 - 16 - 17 - 18 - 19 mm
 - 1/4" - 5/16" - 3/8" - 7/16" - 1/2" - 9/16" - 5/8" - 11/16" - 3/4" - 7/8"
- 20 obstruction ring spanners:
 - 8 x 10 - 11 x 13 - 14 x 15 - 17 x 19 - 21 x 22 mm
 - 5/16" x 3/8" - 7/16" x 1/2" - 9/16" x 5/8" - 11/16" x 3/4" - 13/16" x 7/8"
- 10 S-form double ring wrenches:
 - 10 x 11 - 12 x 13 - 14 x 15 - 16 x 17 - 18 x 19 mm
 - 3/8" x 13/32" - 7/16" x 1/2" - 9/16" x 19/32" - 5/8" x 11/16" - 11/16" x 3/4"
- 10 combination spanners, extra short:
 - 10 - 12 - 13 - 14 - 17 mm
 - 3/8" - 7/16" - 1/2" - 9/16" - 5/8"

Item #	CV 
32500	



VDE Single Open End Spanner Set | 7 - 14 mm | 5 pcs.

- suitable for work on electrical units
- VDE approved
- in practical tetron pouch
- combination spanner 7 mm
- combination spanner 8 mm
- combination spanner 10 mm
- combination spanner 12 mm
- combination spanner 14 mm

Item #
7159



Double Open End Spanner Set | 6x7 - 20x22 mm | 8 pcs.

- hot forged
- chrome plated, polished jaws
- packed in a tetron wallet
- double open end spanner 6x7 - 8x9 - 10x11 - 12x13 - 14x15 - 16x17 - 18x19 - 20x22 mm

Item #	CV
1182	



Double Open End Spanner Set | 6x7 - 17x19 mm | 6 pcs.

- hot forged
- chrome plated, polished jaws
- double open end spanner 6x7 - 8x9 - 10x11 - 12x13 - 14x15 - 17x19 mm



Item #	CV
1179	

Double Open End Spanner Set | 6x7 - 30x32 mm | 12 pcs.

- hot forged
- chrome plated, polished jaws
- packed in a tetron wallet
- double open end spanner 6x7 - 8x9 - 10x11 - 12x13 - 14x15 - 16x17 - 18x19 - 20x22 - 21x23 - 24x27 - 25x28 - 30x32 mm



Item #	Description
1184	Double Open End Spanner Set 6x7 - 30x32 mm 12 pcs.
1184-LEER	Empty Tetron Bag for BGS 1184

Double Open End Spanner Set | 6 - 22 mm | 8 pcs.

- cold forged
- packed in a tetron wallet
- double open end spanner 6x7 - 8x9 - 10x11 - 12x13 - 14x15 - 16x17 - 18x19 - 20x22 mm
- profile: chrome plated
- surface finish: satin chrome plated



Item #	CV
30600	

Double Open End Spanner Set | 6 - 32 mm | 12 pcs.

- cold forged
- packed in a tetron wallet
- double open end spanner 6x7 - 8x9 - 10x11 - 12x13 - 14x15 - 16x17 - 18x19 - 20x22 - 21x23 - 24x27 - 25x28 - 30x32 mm
- profile: satin chrome plated



Item #	CV
30601	

Double Ring Spanner Set | offset | 6 x 7 - 20 x 22 mm | 8 pcs.

- hot forged
- chrome plated, polished jaws
- deep offset ring end
- profile: 12-point
- packed in a tetron wallet
- double ring spanner, deep offset ends, 6x7 - 8x9 - 10x11 - 12x13 - 14x15 - 16x17 - 18x19 - 20x22 mm



Item #
1209



Double Ring Spanner Set | offset | 6 x 7 - 20 x 22 mm | 8 pcs.

- hot forged
- chrome plated, polished jaws
- deep offset ring end
- profile: 12-point
- double ring spanner, deep offset ends, 6x7 - 8x9 - 10x11 - 12x13 - 14x15 - 16x17 - 18x19 - 20x22 mm



Item #
1213



Double Ring Spanner Set | offset | 6 x 7 - 20 x 22 mm | 8 pcs.

- hot forged
- chrome plated, polished jaws
- deep offset ring end
- profile: 12-point
- in a plastic wall holder
- double ring spanner 6x7 - 8x9 - 10x11 - 12x13 - 14x15 - 16x17 - 18x19 - 20x22 mm
- surface finish: chrome plated



Item #
1212



Double Ring Spanner Set | offset | 6 x 7 - 30 x 32 mm | 12 pcs.

- hot forged
- chrome plated, polished jaws
- deep offset ring end
- profile: 12-point
- packed in a tetron wallet
- double ring spanner, deep offset ends: 6x7 - 8x9 - 10x11 - 12x13 - 14x15 - 16x17 - 18x19 - 20x22 - 21x23 - 24x27 - 25x28 - 30x32 mm



Item #	Description
1214	Double Ring Spanner Set offset 6 x 7 - 30 x 32 mm 12 pcs.
1214-LEER	Empty Wallet for BGS 1214



Double Ring Spanner Set | offset | 6 - 32 mm | 12 pcs.

- cold forged
- deep offset ring end
- profile: 12-point
- packed in a tetron wallet
- double ring spanner, deep offset ends: 6x7 - 8x9 - 10x11 - 12x13 - 14x15 - 16x17 - 18x19 - 20x22 - 21x23 - 24x27 - 25x28 - 30x32 mm
- surface finish: satin chrome plated

Item #
30200



Double Ring Spanner Set | offset | 6 x 7 - 20 x 22 mm | 8 pcs.

- cold forged
- deep offset ring end
- profile: 12-point
- packed in a tetron wallet
- double ring spanner, deep offset ends, 6x7 - 8x9 - 10x11 - 12x13 - 14x15 - 16x17 - 18x19 - 20x22 mm
- surface finish: satin chrome plated

Item #
30306



Double Ring Spanner Set | offset | Inch Sizes | 1/4" - 3/4" | 6 pcs.

- cold forged
- satin chrome plated
- deep offset ring end
- profile: 12-point
- packed in a tetron wallet
- double ring spanner 1/4"x5/16" - 3/8"x7/16" - 1/2"x9/16" - 9/16"x5/8" - 19/32" x11/16" - 11/16"x3/4"



Obstruction Ring Spanner Set | 10x13 - 17x19 mm | 3 pcs.

- cold forged
- packed in a tetron wallet
- obstruction ring spanner 10x13 - 14x15 - 17x19 mm
- surface finish: satin chrome plated



Obstruction Ring Spanner Set | 8x10 - 21x22 mm | 5 pcs.

- cold forged
- packed in a tetron wallet
- obstruction ring spanner 8x10 - 11x13 - 14x15 - 17x19 - 21x22 mm
- surface finish: satin chrome plated

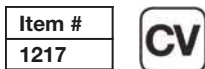

Obstruction Ring Spanner Set | Inch Sizes | 1/4" - 7/8" | 5 pcs.

- cold forged
- packed in a tetron wallet
- 1/4"x5/16" - 3/8"x7/16" - 1/2"x9/16" - 5/8"x11/16" - 3/4"x7/8"
- surface finish: satin chrome plated



Double Ring Spanner Set | S-Type | 10 x 11 - 18 x 19 mm | 5 pcs.

- cold forged
- satin chrome plated
- S-type
- profile: 12-point
- packed in a tetron wallet
- double ring spanner, S-type, 10x11 - 12x13 - 14x15 - 16x17 - 18x19 mm



Item #	CV
1216	

S-Type Double Ring Spanner Set | Inch Sizes | 3/8" - 3/4" | 5 pcs.

- cold forged
- satin chrome plated
- profile ring end: 12-point
- packed in a tetron wallet
- double ring spanner, S-type, 3/8x5/16" - 7/16x1/2" - 9/16x19/32" - 5/8x11/16" - 11/16x3/4"



Item #	CV	1/4" 3/8" 1/2"
32150		

Double Ring Spanner Set | extra flat | 6-22 mm | 8 pcs.

- cold forged
- satin chrome plated
- straight shape
- profile: 12-point
- packed in a tetron wallet
- double ring spanner, extra flat, 6x7 8x9 - 10x11 - 12x13 - 14x15 - 16x17 - 18x19 - 20x22 mm



Item #	Description
30300	Double Ring Spanner Set extra flat 6-22 mm 8 pcs.
30300-LEER	Empty Wallet for BGS 30300

Double Ring Spanner Set | extra long | 8 - 19 mm | 5 pcs.

- cold forged
- chrome plated and mirror polished
- profile ring ends: 12-point
- extra long
- straight type
- packed in a tetron wallet
- double ring spanner 8x10 mm, length: 235 mm
- double ring spanner 11x13 mm, length: 330 mm
- double ring spanner 14x15 mm, length: 370 mm
- double ring spanner 16x17 mm, length: 410 mm
- double ring spanner 18x19 mm, length: 410 mm



Item #	Description
1187	Double Ring Spanner Set extra long 8 - 19 mm 5 pcs.
1187-LEER	Empty Wallet for BGS 1187

Double Ring Spanner Set with E-Type Ring Heads | E6 x E8 - E20 x E24 | 6 pcs.

- hot forged
- satin chrome plated
- straight shape
- profile: E-type
- double ring spanner, E-type, E6xE8 - E7xE11 - E10xE12 - E14xE18 - E16xE22 - E20xE24



Item #
2268



Double Ring Spanner Set with E-Type Ring Heads | E6 x E8 - E20 x E24 | 4 pcs.

- hot forged
- straight shape
- profile: E-type
- double ring spanner, straight: E6xE8 - E10xE12 - E14xE18 - E20xE24
- surface finish: satin chrome plated



Item #
2264



Double Ring Spanner Set with E-Type Ring Heads | offset | E6 - E24 | 6 pcs.

- hot forged
- deep offset ring end
- profile: E-type
- double ring spanner E6xE8 - E7xE11 - E10xE12 - E14xE18 - E16xE22 - E20xE24
- surface finish: satin chrome plated



Item #
2281



Double Ring Spanner, open Type

- chrome plated
- hexagon
- angled 15°



Item #	Description
1745-8X9	Double Ring Spanner, open Type 8 x 9 mm
1750	Double Ring Spanner, open Type 10 x 11 mm
1751	Double Ring Spanner, open Type 12 x 13 mm
1752	Double Ring Spanner, open Type 15 x 17 mm

Double Ring Spanners

- hot forged
- matt chrome plated
- open ring end 15° angled



Item #	Description
1761-8x10	Double Ring Spanner, open Type 8 x 10 mm
1761-9x11	Double Ring Spanner, open Type 9 x 11 mm
1761-12x13	Double Ring Spanner, open Type 12 x 13 mm
1761-14x15	Double Ring Spanner, open Type 14 x 15 mm
1761-16x18	Double Ring Spanner, open Type 16 x 18 mm
1761-17x19	Double Ring Spanner, open Type 17 x 19 mm
1761-19x22	Double Ring Spanner, open Type 19 x 22 mm
1761-24x27	Double Ring Spanner, open Type 24 x 27 mm
1761-30x32	Double Ring Spanner, open Type 30 x 32 mm



Double Ring Spanner Set, open Type | 8 x 9 - 18 x 19 mm | 6 pcs.

- cold forged
- matt chrome plated
- open ring ends 15° angled
- open double ring spanner 8x9 - 10x11 - 12x13 - 14x15 - 16x17 - 18x19 mm



Item #
1745



Double Ring Spanner Set, open Type | 8 x 10 - 17 x 19 mm | 6 pcs.

- hot forged
- matt chrome plated
- open ring end 15° angled
- packed in a tetron wallet
- open double ring spanner 8x10 - 9x11 - 12x13 - 14x15 - 16x18 - 17x19 mm



Item #
1761

Double Ring Spanner Set, open Type | Inch Sizes | 4 pcs.

- cold forged
- matt chrome plated
- open ring ends 15° angled
- open double ring spanner 5/16"x3/8" - 7/16"x1/2" - 9/16"x5/8" - 11/16"x3/4"



Item #
1782

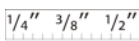

Double Ring Spanner Set, open Type | 10 x 11 / 12 x 13 mm | 2 pcs.

- cold forged
- matt chrome plated
- open ring ends 15° angled
- open double ring spanner 10 x 11 mm (BGS 1750)
- open double ring spanner 12 x 13 mm (BGS 1751)



Item #
1755

Ratchet Wrench Set | up to 90° offset | 8 - 19 mm | 12 pcs.

- Ratchet wrenches, continuously variable up to 90° offset 8 - 9 - 10 - 11 - 12 - 13 - 14 - 15 - 16 - 17 - 18 - 19 mm
- finely toothed, 72 teeth
- surface finish: satin chrome plated



Item #
30950



Ratchet Wrench Set, reversible | 8 - 19 mm | 12 pcs.

- ratchet wrenches 8 - 9 - 10 - 11 - 12 - 13 - 14 - 15 - 16 - 17 - 18 - 19 mm
- finely toothed, 72 teeth
- surface finish: satin chrome plated



Item #
30902



Ratcheting Combination Wrench Set | 8-19 mm | 7 pcs.

- packed in a attractively designed demo case
- finely toothed, 72 teeth
- ratchet wrenches 8 - 10 - 12 - 13 - 14 - 17 - 19 mm
- surface finish: satin chrome plated



Item #
1596



Ratchet Wrench Set | reversible | 8 - 19 mm | 8 pcs.

- short, slightly angled design
- reversible
- in folding bag with zipper
- finely toothed, 72 teeth
- ratchet wrench 8 - 10 - 12 - 13 - 14 - 15 - 17 - 19 mm
- surface finish: satin chrome plated



Item #
30720



Ratchet Wrench Set, with interchangeable, flexible Mini-Heads

- ideally suited for working in confined areas
- handle with rotatable and lockable ratchet head
- detachable ratchet head in following sizes 8 - 9 - 10 - 11 - 12 - 13 - 14 - 15 - 16 - 17 - 18 - 19 mm
- direction of rotation can be reversed by turning the ratchet head around
- finely toothed, 72 teeth



Item #
2258



Ratchet Ring Spanner Set with E-Type Ring Heads | 4 pcs.

- finely toothed, 72 teeth
- ratchet wrench E6 x E8
- ratchet wrench E10 x E12
- ratchet wrench E14 x E18
- ratchet wrench E20 x E24



Item #	CV
2244	

Double Open End Ratchet and Flexible Spanner Set | 8 - 19 mm | 10 pcs.

- cold forged
- matt chrome
- extra long
- with continuously swivelling heads
- profile: 12-point
- double swivel head ratchet wrench set, 8 x 9 mm, length: 237 mm
- double swivel head ratchet wrench set, 10 x 11 mm, length: 294 mm
- double swivel head ratchet wrench set, 12 x 13 mm, length: 327 mm
- double swivel head ratchet wrench set, 14 x 15 mm, length: 370 mm
- double swivel head ratchet wrench set, 16 x 18 mm, length: 409 mm
- double swivel head ratchet wrench set, 17 x 19 mm, length: 412 mm
- 3 socket adaptors:
 - external square 6.3 mm (1/4")
 - external square 10 mm (3/8")
 - external square 12.5 mm (1/2")



Item #	Description
1541	Double Open End Ratchet and Flexible Spanner Set 8 - 19 mm 10 pcs.
1541-LEER	Empty Case for BGS 1541

Ratchet Ring Spanner Set | reversible | "4-in-1" | 3 pcs.

- 3 wrenches with 4 sizes each
- reversible
- packed in a pouch
- finely toothed, 72 teeth
- 1 ratchet wrench 8x9 - 10x11 mm
- 1 ratchet wrench 12x13 - 14x15 mm
- 1 ratchet wrench 16x17 - 18x19 mm



Item #	CV
1556	

Tool Tray 1/6: Ratchet Wrench | 4 pcs.

- fine toothed (72 teeth)
- suitable for pipes
- profile: 12-point
- ratchet wrench 8 mm, BGS 30828
- ratchet wrench 10 mm, BGS 30830
- ratchet wrench 11 mm, BGS 30831
- ratchet wrench 12 mm, BGS 30832

Item #	CV	1/6
30833		



Combination Spanner Set with Ratchet Function | open | 5 pcs.

- ratchet wrench 8 - 9 - 10 - 11 - 12 mm
- fine toothed (72 teeth)
- packed in a tetron wallet
- surface finish: satin chrome plated

Item #	CV
30836	



Ratcheting Combination Wrench

- finely toothed, 72 teeth
- 12 point
- surface finish: satin chrome plated



Item #	Description
1581	Ratchet Wrench 11 mm
1582	Ratchet Wrench 12 mm
1584	Ratchet Wrench 14 mm
1585	Ratchet Wrench 15 mm
1589	Ratchet Wrench 19 mm
1591	Ratchet Wrench 21 mm
1697	Ratchet Wrench 27 mm
1702	Ratchet Wrench 32 mm



E-Type Double Ended Ratchet Wrench | E10 x E12

- fine toothes (72 teeth)
- wrench size 1: E10
- wrench size 2: E12
- profile: E-type

Item #	CV
2244-10x12	



Ratchet Ring Spanners | open

- serrated (72 teeth)
- suitable for pipes
- profile: 12-point



Item #	Description
30828	Ratchet Ring Spanner open 8 mm
30829	Ratchet Ring Spanner open 9 mm
30830	Ratchet Ring Spanner open 10 mm
30831	Ratchet Ring Spanner open 11 mm
30832	Ratchet Ring Spanner open 12 mm
30835	Ratchet Ring Spanner, open 15 mm



Ratchet Combination Wrench | open

- fine toothed (72 teeth)
- suitable for pipes
- surface finish: satin chrome plated



Item #	Description
30838	Ratchet Wrench open 8 mm
30839	Ratchet Wrench open 9 mm
30840	Ratchet Wrench open 10 mm
30841	Ratchet Wrench open 11 mm
30842	Ratchet Wrench open 12 mm



Ratchet Wrench | adjustable

- ratchet is continuously adjustable up to 90° offset
- serrated (72 teeth)
- profile: 12-point
- surface finish: satin chrome plated



Item #	Description
1558	Ratchet Wrench adjustable 8 mm
1560	Ratchet Wrench adjustable 10 mm
1561	Ratchet Wrench adjustable 11 mm
1562	Ratchet Wrench adjustable 12 mm
1564	Ratchet Wrench adjustable 14 mm
1565	Ratchet Wrench adjustable 15 mm
1567	Ratchet Wrench adjustable 17 mm



Ratchet Wrench | reversible

- serrated (72 teeth)
- profile: 12-point
- surface finish: satin chrome-plated



Item #	Description
30908	Ratchet Wrench reversible 8 mm
30911	Ratchet Wrench reversible 11 mm
30914	Ratchet Wrench reversible 14 mm
30915	Ratchet Wrench reversible 15 mm
30917	Ratchet Wrench reversible 17 mm
30918	Ratchet Wrench reversible 18 mm



Ratchet Wrench | short | reversible

- reversible
- serrated (72 teeth)
- 12 point
- satin chrome plated



Item #	Description
30708	Ratchet Wrench short reversible 8 mm
30709	Ratchet Wrench short reversible 9 mm
30710	Ratchet Wrench short reversible 10 mm
30711	Ratchet Wrench short reversible 11 mm
30712	Ratchet Wrench short reversible 12 mm
30713	Ratchet Wrench short reversible 13 mm
30714	Ratchet Wrench short reversible 14 mm
30715	Ratchet Wrench short reversible 15 mm
30716	Ratchet Wrench short reversible 16 mm
30717	Ratchet Wrench short reversible 17 mm
30718	Ratchet Wrench short reversible 18 mm
30719	Ratchet Wrench short reversible 19 mm



Ratchet Wrench "4 in 1"

- serrated (72 teeth)
- satin chrome plated
- each wrench contains 4 sizes



Item #	Description
30809	Double Ended Ratchet Wrench "4 in 1" 8x9, 10x11 mm
30812	Double Ended Ratchet Wrench "4 in 1" 12x13, 14x15 mm
30816	Double Ended Ratchet Wrench "4 in 1" 16x17, 18x19 mm



Adjustable Wrench with Soft Rubber Handle | 3 pcs.

- with millimeter scale
- matt nickel plated
- packed in a tetron wallet
- adjustable wrench, length: 150 mm, fork opening: 0 - 20 mm
- adjustable wrench, length: 200 mm, fork opening: 0 - 25 mm
- adjustable wrench, length: 250 mm, fork opening: 0 - 30 mm



Item #
1446

Adjustable Wrench with Soft Rubber Handle

- matt nickel plated
- with millimeter scale



Item #	Description
1440	Adjustable Wrench with soft Rubber Handle max. 20 mm
1441	Adjustable Wrench with soft Rubber Handle max. 25 mm
1442	Adjustable Wrench with soft Rubber Handle max. 30 mm
1443	Adjustable Wrench with soft Rubber Handle max. 36 mm

Combination Ring Spanner Set | 18 pcs.

- combination spanners, deep offset ring end: 8 - 9 - 10 - 11 - 12 - 13 - 14 - 15 - 16 - 17 - 18 - 19 mm
- flex. socket spanners: 8 x 9 - 10 x 11 - 12 x 13 - 14 x 15 - 16 x 17 - 18 x 19 mm



Item #
1200



Double Ring Spanner Set with flexible Heads | 6 pcs.

- packed in a tetron wallet
- double ring spanner: 8 x 9 - 10 x 11 - 12 x 13 - 14 x 15 - 16 x 17 - 18 x 19
- profile: 12-point



Item #
1201



Double Open End Spanner Set | extra flat | 6 - 23 mm | 7 pcs.

- chrome plated and mirror-polished
- suitable for use under limited space conditions
- spanner thickness: 3 mm
- Double open end spanner, extra flat 6 x 7 mm, length: 101 mm
- Double open end spanner, extra flat 8 x 9 mm, length: 114 mm
- Double open end spanner, extra flat 10 x 12 mm, length: 125 mm
- Double open end spanner, extra flat 11 x 13 mm, length: 138 mm
- Double open end spanner, extra flat 14 x 17 mm, length: 157 mm
- Double open end spanner, extra flat 19 x 21 mm, length: 178 mm
- Double open end spanner, extra flat 22 x 23 mm, length: 200 mm



Item #
9019



Box Spanner Set | 6x7 - 20x22 mm | 9 pcs.

- sizes: 6x7 - 8x9 - 10x11 - 12x13 - 14x15 - 16x17 - 18x19 - 20x22 mm
- packed in a tetron wallet
- surface finish: satin chrome plated



Item #
1218

Special Ring Wrench for Oxygen Sensors | 22 mm

- slotted, swivel head with hexagon and double hexagon drive
- length: 250 mm
- surface finish: chrome-plated



Item #
8272



Hook Wrench Set | 35 - 120 mm | 8 pcs.

- suitable for grooved nuts DIN 1804 and bearing nuts DIN 981
- for diameters: 35-60, 60-90, 90-120 mm
- hook and pin lug are interchangeable



Item #
8542



Special Combination Spanner for Oxygen Probes, open | 22 mm

- short, handy type
- also suited for use with extension tube



Item #
8605



Line Ratchet Wrench Set | 6 pcs.

- suitable for working on pipe screws eg. brake lines, servo lines, oil cooler pipes, etc.
- ratchet function when moving the wrench head
- material: head made of Cr-Mo, black finished
- handle made of hardened steel, chrome plated
- 10 - 11 - 13 - 17 - 19 - 22 mm



Item #
8665



Flare Nut Wrenches

- 2 folding mechanism, especially suitable for pipe fittings
- head made of Chrome-Molybdenum, handle made of S45C steel



Item #	Description
8665-24	Flare Nut Wrench 24 mm
8665-27	Flare Nut Wrench 27 mm
8665-30	Flare Nut Wrench 30 mm
8665-32	Flare Nut Wrench 32 mm



Holder for Combination Spanners | 8 trays

- locking mechanism
- suitable for wrench sizes up to 20 mm
- material: plastic

Item #
1175



Holders for Combination Spanners

- with black plastic handle

Item #	Description
1176	Holder for Combination Spanners 12 supports
1177	Holder for Combination Spanners 15 supports



Adaptor Set for Ratchet Wrenches | 4 pcs.

- 1 adaptor with external square 6.3 mm (1/4") for ring wrench 10 mm
- 1 adaptor with external square 10 mm (3/8") for ring wrench 13 mm
- 1 adaptor with external square 12.5 mm (1/2") for ring wrench 19 mm
- 1 bit adaptor with internal hexagon 6.3 mm (1/4") for ring wrench 10 mm
- with quick release
- can substitute 3 ratchet handles if used with ratchet wrenches
- surface finish: polished chrome metal



Item #
8210



Steel Bench Vice | forged

- 360° rotary table with 3x10 mm mounting holes, lockable by sliding bar
- forged type
- screwed jaws

BGS 59110

- max. clamping range: 120 mm
- length: 345 mm

BGS 59112

- max. clamping range: 150 mm
- length: 385 mm

BGS 59115

- max. clamping range: 200 mm
- length: 400 mm

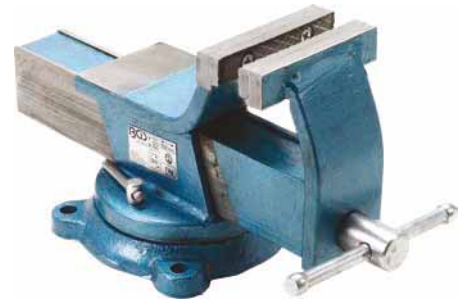

Item #	Description
59110	Steel Bench Vice forged 100 mm Jaws
59112	Steel Bench Vice forged 125 mm Jaws
59115	Steel Bench Vice forged 150 mm Jaws

Bench Vice

- 2 mounting holes Ø 8 mm
- screwed jaws

BGS 59255 (length: 255 mm)

- Mounting hole distance: 83 mm
- max. clamping range: 75 mm

BGS 59260 (length: 270 mm)

- Mounting hole distance: 80 mm
- max. clamping range: 110 mm

BGS 59265 (length: 320 mm)

- Mounting hole distance: 95 mm
- max. clamping range: 130 mm

BGS 59270 (length: 375 mm)

- Mounting hole distance: 107 mm
- max. clamping range: 170 mm

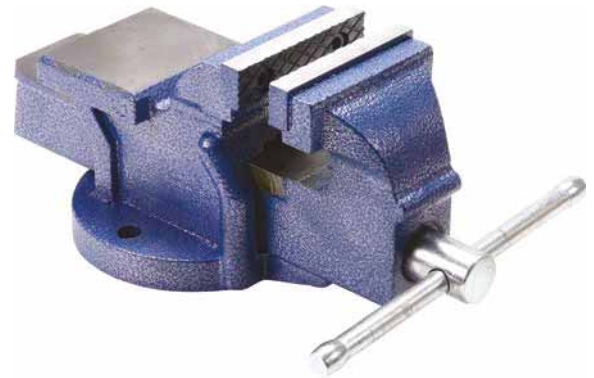

Item #	Description
59255	Bench Vice 75 mm Jaws
59260	Bench Vice 100 mm Jaws
59265	Bench Vice 125 mm Jaws
59270	Bench Vice 150 mm Jaws

Locking Handle for Bench Vices

Item #	Description
59001	Locking Handle for Bench Vices 8 x 200 mm
59003	Locking Handle for Bench Vices 9 x 200 mm
59002	Locking Handle for Bench Vices 9 x 225 mm
59004	Locking Handle for Bench Vices 13 x 250 mm



Bench Vice Jaw Protector | Aluminium | 2 pcs.

- aluminium
- with plastic coating
- embedded magnetic stripe for holding the protection on bench vice

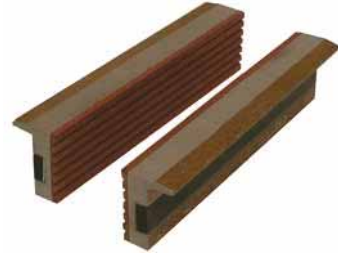

Item #	Description
3044	Bench Vice Jaw Protector Aluminium 125 mm 2 pcs.
3045	Bench Vice Jaw Protector Aluminium 150 mm 2 pcs.

Bench Vice Jaw Protectors | Aluminium | 2 pcs.

- allows gentle clamping of sensitive workpieces
- embedded magnetic stripe for holding the protection on bench vice

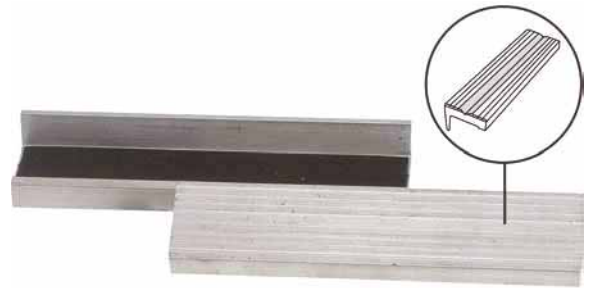

Item #	Description
9282	Bench Vice Jaw Protector Aluminium 125 mm 2 pcs.
9283	Bench Vice Jaw Protector Aluminium 150 mm 2 pcs.

Bench Vice Jaw Protectors | Aluminium | 2 pcs.

- allows gentle clamping of sensitive workpieces
- embedded magnetic stripe for holding the protection on bench vice
- **horizontally V-shaped profile**



Item #	Description
9284	Bench Vice Jaw Protector Aluminium 125 mm 2 pcs.
9285	Bench Vice Jaw Protector Aluminium 150 mm 2 pcs.

Bench Vice Jaw Protector | plastic | 125 mm | 2 pcs.

- allows gentle clamping of sensitive workpieces such as aluminium, cooper, etc.
- embedded magnetic stripe for holding the protection on bench vice
- horizontally and vertically V-shaped profile



Item #
3046



Magnetic Bench Vise Jaw Protectors | 8 pcs.

- with magnets for firm grip on vice
- for gentle clamping
- 2 longitudinal profile jaws for clamping e.g. threaded rods, bolts, etc.
- 2 jaws with longitudinal and transverse profile
- 2 jaws with plastic cover for clamping fragile workpieces
- 2 jaws with rubber plate for clamping very sensitive workpieces, such as aluminium threaded rods and bolts
- made of aluminum
- size: 100 x 25 mm



Item #
8442

F-Clamps

- heavy duty finish

Item #	Description
829	F-Clamp 50 x 200 mm
830	F-Clamp 80 x 300 mm
841	F-Clamp 120 x 300 mm
843	F-Clamp 120 x 500 mm
845	F-Clamp 120 x 1000 mm



Stud Extractor Set | 5 - 16 mm | 11 pcs.

12.5 □ 1/2

- in sizes: 5 - 6 - 7 - 8 - 9 - 10 - 10.5 - 11 - 12 - 14 - 16 mm
- all sockets with external hexagon
- 20 Nm max. torque for each socket
- for dismantling and assembling studs
- 3 clamp rollers for holding the studs
- knurled
- front part high gloss chrome-plated, rear part satin chrome finished
- drive:
 - size 5: 10 mm (3/8") und 19 mm external hexagon
 - sizes 6 - 7 - 8 - 9 - 10 - 10,5 - 11 - 12: 12.5 mm (1/2") und 21 mm external hexagon
 - sizes 14 - 16: 24 mm external hexago

Item #
65515



Stud Extractor Set | 6 - 12 mm | 4 pcs.

12.5 □ 1/2

- sizes: 6 - 8 - 10 - 12 mm
- 12.5 mm (1/2") drive

Item #
1882



Stud Extractors

10 3/8 12.5 1/2

- for dismantling and assembling studs
- 3 clamp rollers for holding the studs
- knurled
- front part high gloss chrome-plated, rear part satin chrome finished
- with external hexagon



Item #	Description
65515-5	Stud Extractor 10 mm (3/8") 5 mm
1883	Stud Extractor 12.5 mm (1/2") 6 mm
65515-7	Stud Extractor 12.5 mm (1/2") 7 mm
1884	Stud Extractor 12.5 mm (1/2") 8 mm
65515-9	Stud Extractor 12.5 mm (1/2") 9 mm
1885	Stud Extractor 12.5 mm (1/2") 10 mm
65515-10.5	Stud Extractor 12.5 mm (1/2") 10.5 mm
65515-11	Stud Extractor 12.5 mm (1/2") 11 mm
1886	Stud Extractor 12.5 mm (1/2") 12 mm
65515-14	Stud Extractor 14 mm
65515-16	Stud Extractor 16 mm



Hand Tools

Stud Extractor Set | 6 - 12 mm | 5 pcs.

- 1 double ring ratchet wrench 14 x 17 mm, reversible
- 4 stud sockets for automatic clamping of studs in the following sizes: 6 - 8 - 10 - 12 mm



Item #	
65505	

Stud Bolt Extractor | 6.3 - 14 mm

- suitable for damaged or broken studs with a diameter 6.3 to 14 mm (1/4" to 9/16")
- adjustable via 19 mm socket

Item #	
1903	



Stud Extractor | 6 - 12 mm

- allows a fast dismantling and mounting of studs
- chuck is suitable for 6 - 12 mm studs
- 36 mm flywheel hexagon chuck, with 24 mm or 12.5 mm (1/2") drive



Item #
8576



Stud Bolt Extractor | 6 - 19 mm

- for loosening stuck studs
- suitable for loosening and tightening
- suitable for studs with diameter from 6 to 19 mm
- knurled and hardened clamp wheel



Item #
8799

Step Drill Set | Ø 4 - 30 mm | 3 pcs.

- HSS steel 6542
- nitride coated
- Step drill Ø 4-12 mm
- Step drill Ø 4-20 mm
- Step drill Ø 6-30 mm



Item #
1945



Step Drill Set | titanium-nitrided | Ø 4 - 30 mm | 3 pcs.

- little abrasion, longer life
- 2 mm ascending steps
- Step drill Ø 4 - 12 mm in following steps: 4 - 5 - 6 - 7 - 8 - 9 - 10 - 11 - 12 mm
- Step drill Ø 4 - 20 mm in following steps: 4 - 6 - 8 - 10 - 12 - 14 - 16 - 18 - 20 mm
- Step drill Ø 4 - 30 mm in following steps: 4 - 6 - 8 - 10 - 12 - 14 - 16 - 18 - 20 - 22 - 24 - 26 - 28 - 30 mm
- material: HSS-steel



Item #
1624



Tapered Hole Cutter Set | HSS | 3 Sizes | 3 pcs.

- size 1: 3 - 14 mm
- size 2: 8 - 20 mm
- size 3: 16 - 30.5 mm



Item #
1998



Countersink Set | with Crosshole | 4 pcs.

- sizes: 2 - 5 mm, 5 - 10 mm, 10 - 15 mm, 15 - 20 mm
- material: HSS-steel



Item #
1966



Countersink Set | HSS | DIN 335 Form C | 6 pcs.

- countersink \varnothing 6.3 - 8.3 - 10.4 - 12.4 - 16.5 - 20.5 mm
- material: HSS-steel



Item #
1997



Step Drills | titanium-nitrided

- little abrasion - longer life
- 2 mm ascending steps



Item #	Description
1618	Step Drill titanium-nitrided Ø 4 - 22 mm
1619	Step Drill titanium-nitrided Ø 4 - 32 mm
1615	Step Drill titanium-nitrided Ø 6 - 40.5 mm



Step Drill | Ø 6 - 30 mm

- sizes: 6 - 8 - 10 - 12 - 14 - 16 - 18 - 20 - 22 - 24 - 26 - 28 - 30 mm
- made of HSS 6542

Item #
1945-1



Sheet Metal Drills

- manufactured from HSS
- for cutting burr-free holes in thin metal sheets, pipes, plastic and similar materials, up to 2 mm thickness
- no clamping of the workpiece required



Item #	Description
1620	Sheet Metal Drill Size 1 3 - 14 mm
1621	Sheet Metal Drill Size 2 8 - 20 mm
1622	Sheet Metal Drill Size 3 16 - 30 mm



Hand Drill | 3 - 12 mm

- designed for the finishing or repairing holes in sheet metal and other materials
- anti-slip 2 component handle

Item #
8892



Cantilever Tool Box

- sheet steel
- heavy duty finish
- in hammertone blue

Item #	Description
3301	Cantilever Tool Box 430 x 200 x 150 mm 3 compartments
3300	Cantilever Tool Box 430 x 200 x 200 mm 5 compartments
3302	Cantilever Tool Box 530 x 200 x 200 mm 5 compartments

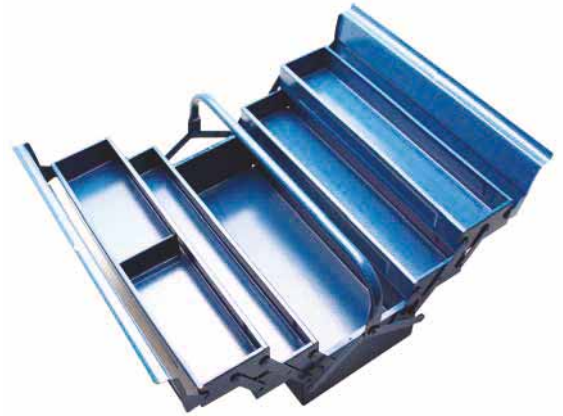

Aluminium Tool Case | 460 x 340 x 150 mm

- with 4-way adjustable dividers
- incl. tool panel and carrying strap
- inside dimensions (bottom) 320 x 440 x 95 mm
- inside dimensions (cover) 320 x 440 x 40 mm (without tool-panel)

Item #
3304



Aluminium Tool Case Set | 3 pcs.

- consisting of 3 aluminium cases in the following sizes:
 - 460 x 160 x 330 mm, max. 12 kg
 - 380 x 120 x 260 mm, max. 10 kg
 - 330 x 90 x 210 mm, max. 8 kg, incl. removable dividers
- suitable for storage of tools, measuring instruments, laptops, photographic equipment, etc.
- special frame holder to lock upper lid in 90° position
- padded with Neoprene rubber
- additional corner protection
- reinforced edges
- lockable, incl. keys

Item #
3307



Roll-up Bag for Tools with 15 Compartments | 660 x 320 mm | empty

- without tools
- length: 660 mm
- width: 320 mm



Item #
3314



Empty Case for Small Parts

- length: 210 mm
- width: 110 mm
- height: 30 mm



Item #
8100



Empty Plastic Case for small parts

- with 23 storage compartments
- dividers removable, customizable sizes
- height of the dividers: 60 mm
- length: 380 mm
- width: 320 mm
- height: 65 mm



Item #
9456

L-Type Wrench Set | "Max" | internal Hexagon 3 - 17 mm | 10 pcs.

- forged
- satin chrome plated
- long side with ball point
- for int hex. screws
- L-type wrench internal hexagon:
 - 3 mm, length: 130 mm
 - 4 mm, length: 145 mm
 - 5 mm, length: 165 mm
 - 6 mm, length: 185 mm
 - 7 mm, length: 195 mm
 - 8 mm, length: 210 mm
 - 10 mm, length: 230 mm
 - 12 mm, length: 265 mm
 - 14 mm, length: 290 mm
 - 17 mm, length: 335 mm



Item #
795



L-Type Wrench Set | internal Hexagon 2 - 10 mm | 8 pcs.

- 2-sided use, short and long shaft
- ergonomic handle
- metal stand with mounting holes
- T-handle wrench internal hexagon
 - 2 x 90 mm
 - 2.5 x 100 mm
 - 3 x 115 mm
 - 4 x 120 mm
 - 5 x 140 mm
 - 6 x 160 mm
 - 8 x 175 mm
 - 10 x 200 mm



Item #	Description
8484	L-Type Wrench Set internal Hexagon 2 - 10 mm 8 pcs.
8484-1	Holder for BGS 8484 Empty

T-Type Wrench Set | internal Hexagon 3 - 8 mm | 5 pcs.

- ergonomically shaped T-handles
- internal hexagon 3 mm, length 100 mm
- internal hexagon 4 mm, length 100 mm
- internal hexagon 5 mm, length 150 mm
- internal hexagon 6 mm, length 150 mm
- internal hexagon 8 mm, length 200 mm
- surface finish: satin chrome plated



Item #
773



Special L-Type Wrench Set | internal Hexagon 1.5 - 10 mm | 9 pcs.

- special profile also works on screws with round corners
- in foldable holder
- L-type Wrench
 - internal hexagon 1.5 mm, length: 92 mm
 - internal hexagon 2 mm, length: 102 mm
 - internal hexagon 2.5 mm, length: 115 mm
 - internal hexagon 3 mm, length: 130 mm
 - internal hexagon 4 mm, length: 144 mm
 - internal hexagon 5 mm, length: 165 mm
 - internal hexagon 6 mm, length: 187 mm
 - internal hexagon 8 mm, length: 207 mm
 - internal hexagon 10 mm, length: 232 mm



Item #	Description
8512	Special L-Type Wrench Set internal Hexagon 1.5 - 10 mm 9 pcs.
8512-1	Demo Block for Hex Wrench Set for BGS 8512

L-Type Wrench Set | extra long | internal Hexagon / internal Hexagon with Ball Head 1.5 - 10 mm | 9 pcs.

- long side with ball point
- in foldable holder
- L-type wrench internal hexagon / internal hexagon
 - with ball point 1.5 mm, length 90 mm
 - with ball point 2 mm, length 100 mm
 - with ball point 2.5 mm, length 115 mm
 - with ball point 3 mm, length 125 mm
 - with ball point 4 mm, length 140 mm
 - with ball point 5 mm, length 165 mm
 - with ball point 6 mm, length 180 mm
 - with ball point 8 mm, length 210 mm
 - with ball point 10 mm, length 230 mm



Item #
790



L-Type Wrench Set | long | internal Hexagon / internal Hexagon with Ball Head 2 - 10 mm | 8 pcs.

- long side with ball point
- short side with straight hexagon
- supplied in a 3-way holder
- L-type wrench internal hexagon / internal hexagon
 - with ball point 2 mm, length 85 mm
 - with ball point 2.5 mm, length 92 mm
 - with ball point 3 mm, length 101 mm
 - with ball point 4 mm, length 109 mm
 - with ball point 5 mm, length 121 mm
 - with ball point 6 mm, length 142 mm
 - with ball point 8 mm, length 163 mm
 - with ball point 10 mm, length 178 mm



Item #
802



L-Type Wrench Set | extra long | internal Hexagon 1.5 - 10 mm | 9 pcs.

- straight hexagon ends
- in a foldable holder
- L-type wrench internal hexagon
 - 1.5 mm
 - 2 mm
 - 2.5 mm
 - 3 mm
 - 4 mm
 - 5 mm
 - 6 mm
 - 8 mm
 - 10 mm



Item #
808



L-Type Wrench Set | extra long | internal Hexagon / internal Hexagon with Ball Head 1.5 - 10 mm | 9 pcs.

- anti slip colour coded
- extra long
- long end with strong magnet and ball head
- in folding holder
- internal hexagon / internal hexagon with ball point
 - 1.5 mm
 - 2 mm
 - 2.5 mm
 - 3 mm
 - 4 mm
 - 5 mm
 - 6 mm
 - 8 mm
 - 10 mm



Item #	CV-S2		
35100			

L-Type Wrench Set | Inch Sizes | internal Hexagon / internal Hexagon with Ball Head 1/16" - 3/8" | 9 pcs.

- long side with ball point
- supplied in a foldable plastic holder
- L-type wrenches internal hexagon / internal hexagon with ball point
 - 1/16"
 - 5/64"
 - 3/32"
 - 1/8"
 - 5/32"
 - 3/16"
 - 1/4"
 - 5/16"
 - 3/8"



Item #	CV-S2			
799				

L-Type Wrench Set | short | internal Hexagon 1.5 - 10 mm | 9 pcs.

- short type
- in foldable holder
- L-type wrenches internal hexagon
 - 1.5 mm
 - 2 mm
 - 2.5 mm
 - 3 mm
 - 4 mm
 - 5 mm
 - 6 mm
 - 8 mm
 - 10 mm



Item #	CV		
807			

L-Type Wrench Set | extra long + extra short Ends | internal Hexagon / internal Hexagon with Ball Head 1.5 - 10 mm | 9 pcs.

- long side with ball point
- short side is extra short
- surface finish: satin chrome plated
- in foldable holder
- L-type wrenches drive internal hexagon / internal hexagon with ball point
 - 1.5 mm, length 80 mm
 - 2 mm, length 100 mm
 - 2.5 mm, length 110 mm
 - 3 mm, length 130 mm
 - 4 mm, length 150 mm
 - 5 mm, length 150 mm
 - 6 mm, length 185 mm
 - 8 mm, length 210 mm
 - 10 mm, length 230 mm





Item #	CV-S2	
9374		

L-Type Wrench Set | extra long | internal Hexagon | Inch Sizes | 9 pcs.

- with anti-slip colour-coding
- long side with ball point and retaining magnet
- in foldable holder
- internal hexagon wrenches
 - 1/16"
 - 5/64"
 - 3/32"
 - 1/8"
 - 5/32"
 - 3/16"
 - 1/4"
 - 5/16"
 - 3/8"

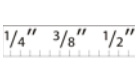

Item #	CV-S2			
35101				

T-Handle Wrench Set | T-Star (for Torx) T10 - T50 | 9 pcs.

- 2-sided use, short and long shaft
- ergonomic handles
- metal stand with mounting holes
- T-handle wrench, T-Star (for Torx)
 - T10 x 100 mm
 - T15 x 115 mm
 - T20 x 120 mm
 - T25 x 130 mm
 - T27 x 140 mm
 - T30 x 150 mm
 - T40 x 160 mm
 - T45 x 175 mm
 - T50 x 200 mm



Item #	CV
8485	

L-Type Wrench Set | T-Star (for Torx) / T-Star tamperproof (for Torx) T10 - T50 | 9 pcs.

- short end is tamperproof
- anti slip color coding
- extra long type
- long end with strong magnet
- with belt clip
- L-type wrench T-Star (for Torx) / T-Star tamperproof (for Torx), with center hole

- T10
- T15
- T20
- T25
- T27
- T30
- T40
- T45
- T50



Item #	CV-S2	
35105		

L-Type Wrench Set | extra long | T-Star (for Torx) T10 - T50 | 9 pcs.

- extra long type
- in foldable holder
- L-type wrench T-Star (for Torx)
 - T10, length: 81 mm
 - T15, length: 97 mm
 - T20, length: 115 mm
 - T25, length: 130 mm
 - T27, length: 150 mm
 - T30, length: 158 mm
 - T40, length: 185 mm
 - T45, length: 208 mm
 - T50, length: 231 mm



Item #	CV-S2	
793		

L-Type Wrench Set | extra long | T-Star tamperproof (for Torx) T10 - T50 | 9 pcs.

- long type
- black tips
- supplied in a clip holder
- L-type wrench T-Star (for Torx), with center hole

- T10
- T15
- T20
- T25
- T27
- T30
- T40
- T45
- T50



Item #	CV-S2	
794		

L-type Wrenches

L-Type Wrench Set | extra long + extra short | T-Star (for Torx) T10 - T50 | 9 pcs.

- long end with center hole
- short side is extra short
- surface finish satin chrome plated
- in foldable holder
- L-type wrench drive T-Star (for Torx)
 - T10, length 90 mm
 - T15, length 100 mm
 - T20, length 110 mm
 - T25, length 130 mm
 - T27, length 140 mm
 - T30, length 160 mm
 - T40, length 185 mm
 - T45, length 205 mm
 - T50, length 230 mm



Item #	CV-S2		
9375			

L-Type Wrench Set | extra long | T-Star tamperproof (for Torx) T10 - T50 | 8 pcs.

- supplied in a 3-way holder
- L-type T-Star tamperproof wrenches (for Torx) in the following sizes:
 - T10, length: 86 x 17 mm
 - T15, length: 90 x 18 mm
 - T20, length: 95 x 19 mm
 - T25, length: 100 x 20 mm
 - T30, length: 114 x 24 mm
 - T40, length: 124 x 26 mm
 - T45, length: 133 x 29 mm
 - T50, length: 152 x 32 mm



Item #	CV-S2		
805			

L-Type Wrench Set | short | T-Star tamperproof (for Torx) T10 - T50 | 9 pcs.

- black ends on long side
- short type
- in foldable holder
- L-type T-Star tamperproof (for Torx)
 - T10
 - T15
 - T20
 - T25
 - T27
 - T30
 - T40
 - T45
 - T50



Item #	CV-S2		
809			

L-Type Wrench Set | extra long | T-Star (for Torx Plus) TS10 - TS50 | 9 pcs.

- for 5-star profile
- matt finished
- extra long (up to 235 mm)
- L-type wrenches T-Star tamperproof (for Torx)
 - TS10
 - TS15
 - TS20
 - TS25
 - TS27
 - TS30
 - TS40
 - TS45
 - TS50



Item #		
777		

L-Type Wrench Set | Spline (for RIBE) M4 - M10 | 7 pcs.

- in plastic holder
- L-type wrenches spline (for Ribe)
 - M4
 - M5
 - M6
 - M7
 - M8
 - M9
 - M10



Item #	
800	

T-Handle L-Type Wrench | Internal Hexagon

- ergonomic 2 component handle



Item #	Description
4010-1	T-Handle L-Type Wrench internal Hexagon 2 mm
4010-2	T-Handle L-Type Wrench internal Hexagon 2.5 mm
4010-3	T-Handle L-Type Wrench internal Hexagon 3 mm
4010-4	T-Handle L-Type Wrench internal Hexagon 4 mm
4010-5	T-Handle L-Type Wrench internal Hexagon 5 mm
4010-6	T-Handle L-Type Wrench internal Hexagon 6 mm
4010-7	T-Handle L-Type Wrench internal Hexagon 7 mm
4010-8	T-Handle L-Type Wrench internal Hexagon 8 mm
4010-9	T-Handle L-Type Wrench internal Hexagon 10 mm



L-Type Wrenches | Extra Long | Internal Hexagon/Internal Hexagon With Ball Point

- long side with ball point
- satin chrome plated



Item #	Description
790-1.5	L-Type Wrench extra long internal Hexagon / internal Hexagon with Ball Head 1.5 mm
790-2	L-Type Wrench extra long internal Hexagon / internal Hexagon with Ball Head 2 mm
790-2.5	L-Type Wrench extra long internal Hexagon / internal Hexagon with Ball Head 2.5 mm
790-3	L-Type Wrench extra long internal Hexagon / internal Hexagon with Ball Head 3 mm
790-4	L-Type Wrench extra long internal Hexagon / internal Hexagon with Ball Head 4 mm
790-5	L-Type Wrench extra long internal Hexagon / internal Hexagon with Ball Head 5 mm
790-6	L-Type Wrench extra long internal Hexagon / internal Hexagon with Ball Head 6 mm
790-7	L-Type Wrench extra long internal Hexagon / internal Hexagon with Ball Head 7 mm
790-8	L-Type Wrench extra long internal Hexagon / internal Hexagon with Ball Head 8 mm
790-9	L-Type Wrench extra long internal Hexagon / internal Hexagon with Ball Head 9 mm
790-10	L-Type Wrench extra long internal Hexagon / internal Hexagon with Ball Head 10 mm



T-Handle Wrench | T-Star (for Torx)

- ergonomic 2 component handle



Item #	Description
4010-10	T-Handle L-Type Wrench T-Star (for Torx) T10
4010-11	T-Handle L-Type Wrench T-Star (for Torx) T15
4010-12	T-Handle L-Type Wrench T-Star (for Torx) T20
4010-13	T-Handle L-Type Wrench T-Star (for Torx) T25
4010-14	T-Handle L-Type Wrench T-Star (for Torx) T27
4010-15	T-Handle L-Type Wrench T-Star (for Torx) T30
4010-16	T-Handle L-Type Wrench T-Star (for Torx) T40
4010-17	T-Handle L-Type Wrench T-Star (for Torx) T45
4010-18	T-Handle L-Type Wrench T-Star (for Torx) T50



L-Type Wrenches | extra long | T-Star tamperproof (for Torx)

- short arm drive profile: T-Star (for Torx)
- long arm drive profile: T-Star tamperproof (for Torx)
- surface finish: satin chrome plated



Item #	Description
794-T10	L-Type Wrench extra long T-Star tamperproof (for Torx) T10
794-T15	L-Type Wrench extra long T-Star tamperproof (for Torx) T15
794-T20	L-Type Wrench extra long T-Star tamperproof (for Torx) T20
794-T25	L-Type Wrench extra long T-Star tamperproof (for Torx) T25
794-T27	L-Type Wrench extra long T-Star tamperproof (for Torx) T27
794-T30	L-Type Wrench extra long T-Star tamperproof (for Torx) T30
794-T40	L-Type Wrench extra long T-Star tamperproof (for Torx) T40
794-T45	L-Type Wrench extra long T-Star tamperproof (for Torx) T45
794-T50	L-Type Wrench extra long T-Star tamperproof (for Torx) T50



L-type Wrenches / Pliers

Wire Stripping Pliers | 150 mm

- 2-component handles
- surface finish: nickel plated, matt



VDE Wire Stripping Pliers | 160 mm

- VDE approved according to DIN EN 60 900:2012
- 2-component anti-slip handles



Wire Stripping Pliers | 215 mm

- for stripping cables: 0.5 - 0.65 - 0.8 - 1.0 - 1.3 - 1.6 - 2.0 mm or 12 - 14 - 16 - 18 - 20 - 22 - 24 AWG and 6 mm coaxial cables
- for crimping non-insulated terminals: 0.3 - 0.5 - 1.25 - 2.0 mm
- specially hardened carbon steel



Crimping Tool | 200 mm

- with wire cutter
- especially for non-insulated terminals 1.5 - 2.5 - 6 mm
- 3 mm thickness
- wire stripper 0.75 - 1.0 - 1.5 - 2.5 - 4.0 - 6.0 mm
- spark plug crimper
- bolt head cutter M2.6 - M3 - M3.5 - M4- M5

Item #
1422

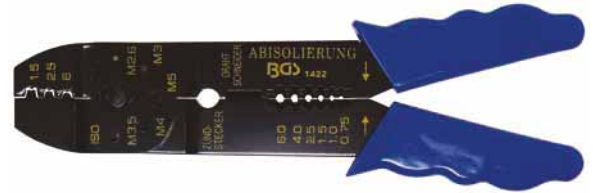

Crimping Tool | 235 mm

- with wire cutter
- combined tool for insulated and non-insulated terminals
- soft blue handles
- 3 mm thick steel
- for non-insulated terminal sizes 1.5 - 2.5 - 4.6 mm
- for insulated terminal sizes: 1.5 mm (red) - 2.5 mm (blue) - 6 mm (yellow)
- wire stripper 0.75 - 1.0 - 1.5 - 2.5 - 4.0 - 6.0 mm
- bolt head cutter M2.6 - M3 - M3.5 - M4- M5

Item #
418



Automatic Wire Stripper | for wire Ø 0.13 - 6 mm | 210 mm

- for wire diameters 0.13 - 6 mm²
- with cutter for insulated/not insulated terminals

Item #
442



Wire Stripping Pliers

- self-adjusting for cable Ø 0.2 - 6 mm²
- front-cutting with adjustable length stop for stripping from 8 to 12 mm
- cutter up to 2 mm diameter
- locking device for space saving storage and protection of the blades

Item #
8379



Wire & Cable Stripper "2-IN-1"

- for stripping cables and wires
- sharp precision shear-type blades for clean cuts on solid and stranded copper wire
- easy-to-read markings
- spring-loaded mechanism provides fast self-opening action
- compact size design with locking function
- includes 2 spare blades
- material: ABS housing with carbon steel blade
- length: 115 mm



Item #	Description
8489	Wire & Cable Stripper "2-IN-1" 0.2 - 0.8 mm
8490	Wire & Cable Stripper "2-IN-1" 0.8 - 2.6 mm



Pliers

Waterproof Connector Assortment | 232 pcs.

- for repairing of existing cabling and for new wiring
- suitable for automotive voltage applications up to 24V

includes the following Delphi® waterproof connector parts:

- 25 x 1.4 mm wire seals for wire Ø 1.4 - 1.9 mm
- 30 x 2.5 mm wire seals for wire Ø 2.5 - 3.4 mm
- 25 x 2.8 mm wire seals for wire Ø 2.9 up to 3.8 mm
- 20 x 0.50 - 0.85 mm² male terminals
- 20 x 0.50 - 0.85 mm² female terminals
- 20 x 1.25 - 2.0 mm² male terminals
- 20 x 1.25 - 2.0 mm² female terminals
- 20 x 3 mm² male terminals
- 20 x 3 mm² female terminals
- 5 x 1-pole housings for male terminals
- 5 x 1-pole housings for female terminals
- 3 x 2-pole housings for male terminals
- 3 x 2-pole housings for female terminals
- 4 x 3-pole housings (single-row type) for male terminals
- 4 x 3-pole housings (single-row type) for female terminals
- 2 x 4-pole housings (single-row type) for male terminals
- 2 x 4-pole housings (single-row type) for female terminals
- 2 x 4-pole housings (two-row type) for male terminals
- 2 x 4-pole housings (two-row type) for female terminals



Item #
9096

Crimping Pliers Set with Waterproof Connector Parts | 220 pcs.

- for repairing of the existing cabling and for new wiring
- quick change ratchet crimper (aluminium made)
- H6 pair of jaws for wire sizes: DIN 0.35 / 0.5 - 0.8 mm² (AWG 22 / 20-18)
- H7 pair of jaws for wire sizes: DIN 1.0 - 2.0 / 3.0 mm² (AWG 16-14 / 12)
- release tool for terminals

includes following Delphi® waterproof connector parts:

- 25 x 1.4 mm wire seals for wire Ø 1.4 - 1.9 mm
- 30 x 2.5 mm wire seals for wire Ø 2.5 - 3.4 mm
- 25 x 2.8 mm wire seals for wire Ø 2.9 up to 3.8 mm
- 20 x 0.50 - 0.85 mm² male terminals
- 20 x 0.50 - 0.85 mm² female terminals
- 20 x 1.25 - 2.0 mm² male terminals
- 20 x 1.25 - 2.0 mm² female terminals
- 20 x 3 mm² male terminals
- 20 x 3 mm² female terminals
- 3 x 1-pole housings for male terminals
- 3 x 1-pole housings for female terminals
- 2 x 2-pole housings for male terminals
- 2 x 2-pole housings for female terminals
- 1 x 3-pole housings (single-row type) for male terminals
- 1 x 3-pole housings (single-row type) for female terminals
- 1 x 4-pole housings (single-row type) for male terminals
- 1 x 4-pole housings (single-row type) for female terminals
- 1 x 4-pole housings (two-row type) for male terminals
- 1 x 4-pole housings (two-row type) for female terminals



Item #
9097

Crimping Tool Set with 5 Pairs of Jaws

- for crimping insulated connector types
- ratchet mechanism holds the connector in position, facilitates inserting the cable into the connector

includes following quick interchangeable crimping jaws:

- A1 for 0.5 - 10 mm² insulated heat shrink butt connectors
- A2 for 0.5 - 6 mm² insulated terminals
- A3 for 0.1 - 1.5 mm² miniature insulated connectors
- A4 for 0.5 - 2.5 mm² insulated 90 degree flag connectors
- A5 for 0.5 - 6 mm² closed end insulated connectors and heat shrinkable terminals



Item #
9098

Crimping Tool Set with 5 Pairs of Jaws

- crimping tool set with ratcheting function, adjustable jaws an pressure point unlocking
- supplied in an acid-proof blow mould case

includes 5 exchangeable pairs of crimping jaws for:

- closed non-insulated terminal ends:
 - AWG 20-18 / 16-14 / 12-10 / 8
 - DIN 1.5 / 2.5 / 6 / 10 mm²
- insulated terminal ends:
 - AWG 22-18 / 16-14 / 12-10
 - DIN 0.5-1.0 / 1.5-2.5 / 4-6 mm²
- open, non-insulated terminal end:
 - AWG 22-18 / 16-14 / 12-10
 - DIN 0.5-1.0 / 1.5-2.5 / 4-6 mm²
- small, insulated terminal end
 - AWG 22-18 / 16-14 / 12-10
 - DIN 0.5-1.0 / 1.5-2.5 / 4-6 mm²
- big, insulated terminal end:
 - AWG 10 / 8 / 6
 - DIN 6 / 10 / 16 mm²

Item #	Description
1410	Crimping Tool Set with 5 Pairs of Jaws
1410-A	Crimping Jaws for insulated Cable Lugs for BGS 1410, 1411, 1412
1410-B	Crimping Jaws for non-insulated, closed Cable Clamps for BGS 1410, 1411, 1412
1410-BNC	Crimping Jaws for BNC/TNC coaxial Plugs for BGS 1410, 1411, 1412
1410-C	Crimping Jaws for open Terminals for BGS 1410, 1411, 1412
1410-C1	Crimping Jaws for open Terminals for BGS 1410, 1411, 1412
1410-D	Crimping Jaws for insulated small cord-end Terminals for BGS 1410, 1411, 1412
1410-F	Crimping Jaws for large, insulated cord-end Terminals for BGS 1410, 1411, 1412
1410-H	Crimping Jaws for D-USB V3.5 for BGS 1410, 1411, 1412
1410-H1	Crimping Jaws for Spark Plug Connectors for BGS 1410, 1411, 1412
1410-I2	Crimping Jaws for Solar Connector MC4 for BGS 1410, 1411, 1412

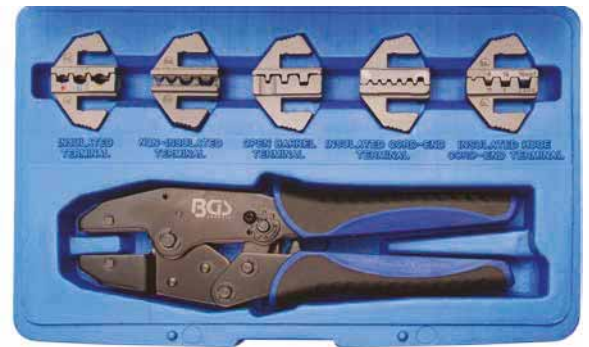

Pliers

Crimping Pliers Set with Cable Lug Assortment | 1000 pcs.

- crimping tool set with ratcheting function and adjustable jaws
- supplied in an acid-proof blow mould case

includes 2 exchangeable pairs of crimping jaws for:

- insulated end terminals 0.5 - 6 mm² (red-blue-yellow) with symmetrical oval pressing
- non-insulated end terminals 1.5 - 10 mm² with mandrel pressing
- set includes 1000 different cable terminals

Item #
1411



Crimping Pliers | exchangeable Jaws

- crimping tool set with ratcheting function
- 2 exchangeable pairs of jaws for - non-insulated end terminals 0.5 - 6 mm² (red-blue-yellow)
- non-insulated end terminals 1.5 - 10 mm² with closed cable attachment ring

Item #
1412



Ratchet Crimping Tool | for Cable End Sleeves 0.5 - 4 mm²

- heavy insulated handle
- suitable for conductor sleeves in sizes 0.5 - 0.75 - 1.0 - 1.5 - 2.5 - 4 mm²
- length: 215 mm

Item #
1418



Ratchet Crimping Tool | for uninsulated Cable Lugs 0.5 - 6 mm²

- for open, non-insulated terminals
- 0.5-1-1.5-2.5-4-6 qmm



Item #	Description
1419	Ratchet Crimping Tool for uninsulated Cable Lugs 0.5 - 6 mm ²
1417	Replacement Crimping Jaws for BGS 1419



Ratchet Crimping Tool | for insulated Terminals 0.5 - 6 mm²

- insulated handles
- for insulated terminal sizes: 0.5 - 1.5 / 1.5 - 2.5 / 4 - 6 mm²
- length: 215 mm
- surface finish: burnished

Item #
1426



Crimping Tool | for Cable End Sleeves, 0.5 - 2.5 mm²

- forged
- insulated cushion-grip handles
- suitable for cable end sleeves in sizes 0.5 - 0.75 - 1.0 - 1.5 - 2.5 mm²
- length: 150 mm

Item #
1428



Cable Lug Crimping Tool | for Cable End Sleeves up to 16.0 mm²

- forged
- insulated cushion-grip handles
- can be used for cable end sleeves in sizes: 0.5 - 0.75 - 1.0 - 1.5 - 2.5 - 4.0 - 6.0 - 10.0 - 16.0 mm²
- length: 190 mm

Item #
1429



Crimping Pliers | for Cable Lugs | 6 - 50 mm²

- crimping pliers with 6-fold crimp profile
- for cable lugs, series and parallel connectors
- for copper and aluminium cable lugs from 6 - 50 mm²
- rotatable and lockable crimp die pairs in sizes: 6 - 10 - 16 - 25 - 35 - 50 mm²
- anti-slip handles with finger recesses for safe working
- insulated handles
- lever length: 250 mm
- total length: 390 mm

Item #
9397



Locking Grip Pliers Set | 16 pcs.

- all pliers have strong non-slip rubber handles
- 3 round nose locking pliers, 185 x 55mm
- 5 big locking pliers, 235 x 65 mm
- 2 small locking pliers
- 2 welding locking pliers 235 x 65 mm
- 2 round nose locking pliers, 280 x 140 mm
- 1 medium locking pliers
- 1 small locking pliers

Item #
4495



Locking Grip Pliers Set | 4 pcs.

- adjustable contact pressure
- packed in wallet
- self grip pliers 125 mm
- self grip pliers 180 mm
- self grip pliers 250 mm
- long nose pliers 150 mm



Item #
494

Mini Locking Grip Pliers Set | 3 pcs.

- long nose self grip pliers, 135 mm length
- welding self grip pliers, 130 mm length
- self grip pliers, 110 mm length



Item #
4499



Locking Grip Pliers | extra short | 100 mm

- 6 times riveted
- curved jaws
- extra small size
- material: special steel
- surface finish: chrome plated



Item #
505



Locking Grip Pliers | 3-way adjustable | 225 mm

- gripping
- range up to 55 mm
- material: special steel
- surface finish: chrome plated



Item #
493



Locking Grip Pliers | 225 mm

- polished jaws
- adjustable
- material: special steel
- surface finish: black burnished

Item #
485



Locking Grip Pliers | with Vinyl Release Lever | 250 mm

- vinyl quick release lever
- material: special steel
- surface finish: nickel plated

Item #
4490



Locking Grip Pliers | with Vinyl Release Lever | 250 mm

- professional quality
- vinyl quick release lever
- in colour box
- surface finish: nickel plated

Item #
4491



Locking Grip Pliers | with Hammer Adaptor | 250 mm

- for use with sliding hammer
- surface finish: chrome-plated

Item #
4494



Locking Long Nose Grip Pliers | extra short | 125 mm

- 6 times riveted
- straight jaws
- material: special steel
- surface finish: nickel plated

Item #
506



Locking Long Nose Grip Pliers

- special steel
- forged
- nickel plated
- tempered jaws



Item #	Description
474	Locking Long Nose Grip Pliers 170 mm
475	Locking Long Nose Grip Pliers 225 mm
476	Locking Long Nose Grip Pliers 250 mm



Welding Locking Grip Pliers | extra short | 110 mm

- 5 times riveted
- for holding bulky pieces of work
- flexible jaws
- extra small size
- material: special steel
- surface finish: chrome plated
- max. clamping width: 35 mm

Item #
507



Locking Welding Grip C-Clamp | 280 mm

- forged
- material: special steel
- surface finish: nickel plated

Item #
496



Locking Welding C-Clamp | 475 mm

- forged
- material: special steel
- surface finish: nickel plated
- max. clamping depth: 250 mm
- max. clamping width: 85 mm

Item #
497



Locking Welding Grip Pliers | with Vinyl Release Lever | 280 mm

- forged
- opening with vinyl quick release lever
- material: special steel
- surface finish: nickel plated

Item #
495



Locking Long Nose Grip Pliers

- special steel
- satin chrome plated



Item #	Description
4496	Locking Long Nose Grip Pliers 380 mm
4497	Locking Long Nose Grip Pliers 500 mm



Fitting Clamp Locking Grip Pliers | for Ø 6 - 16 mm

- for adopting connection fittings
- clamps Ø 6 - 8 - 10 - 12 and 16 mm
- surface finish: satin chrome plated

Item #
4498



Locking Grip Pliers | Special Shape | 240 mm

- max. opening: 55 mm
- jaws made from chrome vanadium steel (S2)
- handles and mechanisms made of chrome molybdenum steel
- jaw material: chrome vanadium steel
- surface finish: chrome plated

Item #
4500



Locking Grip Pliers | Claw Design | 210 mm | 6 - 32 mm

- perfect hold on damaged screws/bolts through special claw design
- secure hold on pipes and lines
- material: special steel



Item #
491

Locking Grip Pliers | with Quick Release Lever | 225 mm

- for working on car bodies, forging and clamping on door frames, wheel arches, side panels, flanges, sheets and others
- for spot welding in between the jaws (e.g. door frames, flanges, etc.)



Item #
480

Locking Grip Pliers | with Quick Release Lever | 210 mm

- for working on car bodies, forging and clamping on door frames, wheel arches side panels, flanges, sheets and many more
- for spot welding in between the jaws
- diverse applications possible (e.g. side panels, roof, etc.)



Item #
482

Locking Grip Pliers | with Quick Release Lever | 220 mm

- for working on car bodies, forging and clamping on door frames, wheel arches, side panels, flanges, sheets and many more
- for working on the whole body
- perfect assistance while assembling doors, wheel arches etc.
- length: 220 mm



Item #
484

Fixing Clamps Set with Pliers | 11 pcs.

- for fast and easy fixing during glueing and welding of sheet metal parts
- for time- and cost-saving body work
- the economical alternative to conventional locking pliers with size advantage
- large clamping range in relation to the size
- re-adjustment of sheet metal is possible at any time
- pliers in angled shape allow access even to difficult places such as door pillars, quarter window etc.
- includes 10 universal steel clamps
- clamp opening: 0 to 5 mm



Item #	Description
8774	Fixing Clamps Set with Pliers 11 pcs.
8774-1	Fixing Clamps for BGS 8774 10 pcs.

Riveter Set | long arm | 3.2 - 6.4 mm

- for aluminium and steel rivets
- 5 nosepieces, sizes: 3.2 - 4.0 - 4.8 - 5.0 - 6.4 mm
- suitable for rivet nuts M4, M5, M6, M8 und M10
- incl. draw bar for riveter M4, M5, M6, M8 und M10
- rivet stroke: max. 20 mm
- handles can be folded



Item #	Description
405	Riveter Set long arm 3.2 - 6.4 mm
405-1	Pull Bar for BGS 405
405-2	Replacement Pair of Jaws for BGS 405, 3284
405-3	Jaw Case for BGS 405
405-4	Rivet Nut Head for BGS 405
405-M10	Rivet Nut Tension Extension for BGS 405 with M10 Nut
405-M4	Rivet Nut Tension Extension for BGS 405 with M4 Nut
405-M5	Rivet Nut Tension Extension for BGS 405 with M5 Nut
405-M6	Rivet Nut Tension Extension for BGS 405 with M6 Nut
405-M8	Rivet Nut Tension Extension for BGS 405 with M8 Nut
405-Zange	Riveter long arm

Nut Riveter | M3 - M10 | 68 pcs.

- ideal for hard to reach places
- for rivet nuts M3, M4, M5, M6, M8, M10
- suitable for aluminium and steel rivet nuts
- nosepiece / mandrel pairs for M3, M4, M5, M6, M8, M10
- incl. 10 pieces of each rivet nuts M3, M4, M5, M6, M8, M10
- max. stroke: 9 mm
- length: 330 mm
- weight: 1100 g
- length: 330 mm



Item #
408

Riveter | long arm | with Collecting Bottle

- bottle helps to keep work environment clean and safe
- 220 mm handles for strong leverage
- incl. nosepieces for 2.4 mm (3/32"), 3.2 mm (1/8"), 4.0 mm (5/32") and 4.8 mm (3/16")
- suitable for steel rivets
- length: 220 mm



Item #	Description
409	Riveter long arm with Collecting Bottle
409-1	Replacement Claws for BGS 409

Hand Riveter

- suitable for rivets made of aluminium, copper and steel, diameters of 2.4 - 3.2 - 4.0 - 4.8 mm



Item #	Description
402	Hand Riveter
402-2	Spare Mouthpiece for BGS 402 2.4 / 3.2 / 4.0 / 4.8 mm



Blind Rivet Attachment | 2.4 - 3.2 - 4.0 - 4.8 mm

- converts any drill into a rivet gun
- works with standard electric drills (reversible, min. torque 15 Nm)
- with mounting key
- for aluminium rivets 2.4 - 4.8 mm
- for stainless steel rivets 2.4 - 4.0 mm
- with hexagon shaft 6.3 mm (1/4") - 6.35 mm

Item #
406



Rivet Nut Attachment | M3 / M4 / M5 / M6

- converts any drill into a rivet gun
- works with standard electric drills (reversible, min. torque 20 Nm)
- with mounting key
- with threaded mandrels and nosepieces in M3 - M4 - M5 - M6

Item #
407



Plastic Rivet Kit

- for riveting e.g. plastic panels in the interior of vehicles, boats, etc.
- suitable for plastic blind rivets with mandrel diameter 2 - 4.5 mm
- 1 riveter
- contains 40 plastic blind rivets in the following sizes:
 - 10x Ø 5.0 x 15.8 mm
 - 10x Ø 5.0 x 17.2 mm
 - 10x Ø 6.6 x 17.2 mm
 - 10x Ø 6.3 x 25.2 mm



Item #	Description
8463	Plastic Rivet Kit
8463-1	Blind Rivets for BGS 8463 5.0 x 15.8 mm 10 pcs.
8463-2	Blind Rivets for BGS 8463 5.0 x 17.2 mm 10 pcs.
8463-3	Blind Rivets for BGS 8463 6.6 x 17.2 mm 10 pcs.
8463-4	Blind Rivets for BGS 8463 6.3 x 25.2 mm 10 pcs.



Pliers

Gaspiper Pliers | 3-Point Grip

- red lacquered
- polished jaws
- special advantage: 3-point grip prevents slipping off



Item #	Description
525	Gaspiper Pliers 1" 3-Point Grip
526	Gaspiper Pliers 1.5" 3-Point Grip
527	Gaspiper Pliers 2" 3-Point Grip



One-Hand Pipe Wrench | 270 mm | 50 mm

- plier head 180° rotatable and lockable in 18 positions
- opening max. 50 mm
- length: 270 mm
- max. clamping width: 50 mm



Item #	Image
528	

One-Hand Pipe Wrenches

- American model (Stillson Type)
- adjustable
- BGS 540, One-Hand Pipe Wrench, length: 250 mm, maximum opening: 6 - 25 mm
- BGS 541, One-Hand Pipe Wrench, length: 300 mm, maximum opening: 13 - 32 mm
- BGS 542, One-Hand Pipe Wrench, length: 350 mm, maximum opening: 13 - 38 mm
- BGS 543, One-Hand Pipe Wrench, length: 450 mm, maximum opening: 25 - 51 mm
- BGS 544, One-Hand Pipe Wrench, length: 600 mm, maximum opening: 38 - 64 mm



Item #	Description
540	One-Hand Pipe Wrench 250 mm 6 - 25 mm
541	One-Hand Pipe Wrench 300 mm 13 - 32 mm
542	One-Hand Pipe Wrench 350 mm 13 - 38 mm
543	One-Hand Pipe Wrench 450 mm 25 - 51 mm
544	One-Hand Pipe Wrench 600 mm 38 - 64 mm

Tool Tray 3/3: Hose Clamp Pliers Set

- dimensions (W x D x H) 567 x 408 x 32 mm
- BGS 8412 ratcheting hose clip pliers 0 - 38 mm
 - opening from 0 up to 38 mm
 - ratchet locking function
 - opens using spring mechanism
- BGS 471 hose clip pliers CLIC / CLIC-R
 - 190 mm length
 - turnable, angled jaws
- BGS 473 ratcheting hose clip pliers
 - for spring pipe clamps
 - interchangeable jaws (2 pairs)
 - length 200 mm
- BGS 161 CV-joint boot pliers
 - with ear-type holder, prevents loosening of sleeve fastening
 - universal use, works on fuel hoses, CV boots
 - for working on Oetiker System hose clamps
 - length 235 mm
- BGS 8600 hose clamp pliers
 - specifically made for space-saving hose clips
 - ratchet mechanism for holding hose clips open
 - especially suitable for new type hose clips on VAG fuel lines
- BGS 470 hose clamp pliers with bowden cable
 - for installation and removal of 18 - 54 mm long elastic, self-locking, spring steel collars
 - can be used even in narrow spaces
 - length 630 mm
- BGS 8804 Hose clamp tool
 - suitable for spring steel band clamps
 - by turning the knurled nut, the tool opens the hose clamp and it can remain in this position until the disassembly / assembly is complete
 - max. opening: 62 mm

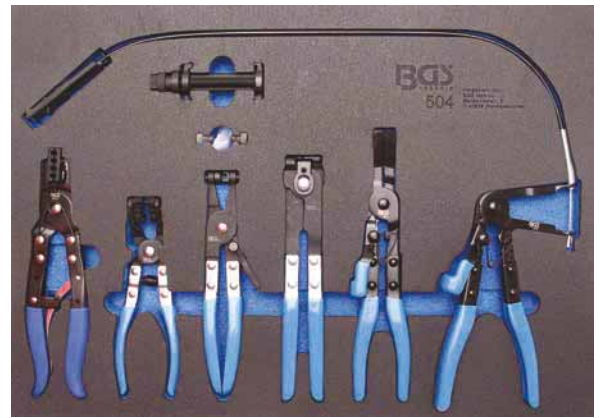

Pliers

Item #	
504	

Hose Clamp Tool | 0 - 40 mm

- for tensioning spring steel hose clamps
- particularly useful in confined spaces
- knurled wheel for pre-tensioning
- 10 mm (3/8") drive for ratchets, extension bars, etc.
- jaw capacity: 0 to 40 mm
- material: carbon steel
- surface finish: chrome plated

Item #	
8805	



Hose Clamp Tool | 0 - 40 mm

- also usable on new style VAG clips
- hand drive or socket drive

Item #
8804



Tensioning Tool | for Spring Band Hose Clamps

- for tensioning spring band clamps on e. g. coolant and fuel hoses
- knurled nut for adjusting the tensioning width
- max. clamping range: 53 mm
- material: zinc alloy / chrome plated steel
- high strength due to lever handle

Item #
9279



Spring Clamp Pliers | for Fuel Lines | 180 mm

- suitable for Audi, Seat, Skoda and Volkswagen (VAG)
- especially suitable for spring clamps on fuel lines
- facilitates the dismantling and assembly of small spring clamps
- hardened, warp-free claw
- with spring mechanism

Item #
66102



Hose Clamp Pliers | 200 mm

- ratchet locking function for spring clamps
- interchangeable jaws (2 pairs)

Item #
473



Hose Clamp Pliers | Bent Type | with Ratcheting Function | 220 mm

- with ratcheting function

Item #
477



Hose Clamp Pliers | with Bowden Cable | 630 mm | 18 - 54 mm

- for mounting and removal of all flexible, self-locking belt clamps from 18 - 54 mm
- for use even in narrow spaces
- black finished



Item #	Description
470	Hose Clamp Pliers with Bowden Cable 630 mm 18 - 54 mm
47	Spare Bowden Cable for BGS 467, 470

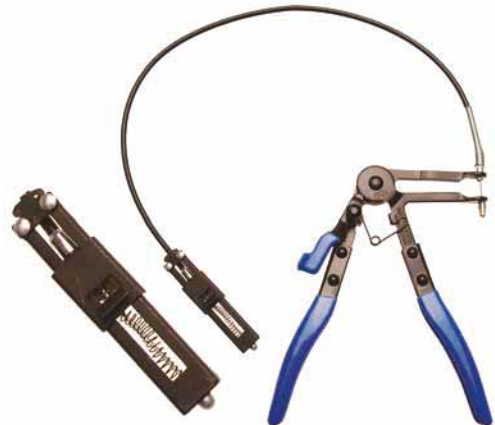

Hose Clamp Pliers | Semi-Flexible | 850 mm | 18 - 54 mm

- suitable for self-tensioning spring clamps with a diameter of 18 to 54 mm
- semi-flexible design makes it perfect for hard-to-reach self-tensioning spring-clip clamps
- with reinforced bowden cable including locking mechanism and inner spring
- with slip-resistant dip-coated handles

Item #
472



Hose Clamp Pliers | 230 mm

- for loosening hose clamps
- adjustable in 2 steps
- toothed gripping jaws for better grip
- slip-proof handles

Item #
8409



Hose Clamp Pliers

- dip coated handles
- ratchet locking function
- opens through spring mechanism



Item #	Description
8412	Hose Clamp Pliers 245 mm 0 - 38 mm
8414	Hose Clamp Pliers 245 mm 22 - 55 mm



Hose Clamp Pliers | 260 mm

- especially made for space-saving hose clips
- ratchet mechanism for holding hose clips open
- suitable for most vehicles such as Alfa Romeo, Citroen, Fiat, Ford, Hyundai, Lancia, Mercedes, Opel, Peugeot, Porsche, Renault, Seat, Skoda, Toyota, Volvo, etc.
- especially suitable for new type hose clips on VAG fuel lines

Item #
8600



Hose Clamp Pliers | 245 mm

- for compressing clips (Oetiker system), for example on fuel lines, coolant lines, axle boots
- max. clamping width: 31 mm

Item #
466



Hose Clip Pliers with Swivel Head | 210 mm

- heads can rotate 360°, for lateral pre-tensioning of hose clamps
- suitable for CLIC type hose clamps on fuel lines

Item #
499



Hose Clamp Pliers | for CLIC-R Hose Clamps

- for installation and removal of CLIC-R hose clamps
- good for use even in narrow spaces
- 630 mm bowden cable length



Item #
8752



Hose Clamp Pliers | for CLIC and CLIC-R Hose Clamps | 190 mm

- revolving jaws



Item #
471



Hose Clamp Pliers | for CLIC Hose Clamps | 175 mm

- disassembly and assembly of Clic hose clamps
- suitable for VW-Audi, Citroen, Mercedes, Opel (Vauxhall), Peugeot, etc.
- hardened jaws
- chrome plated handle



Item #
8347



Hose Clamp Pliers | for CLIC-L Hose Clamps | 150 mm

- allows easy and fast unlocking and locking of clipped, reusable hose clamps



Item #
8470



Pliers for Self-Locking Metal Bands

- for tightening of self-locking metal bands installed on e.g. axle boots
- suitable for metal bands up to max. 10 x 0.4 mm



Item #
439

Pliers for Axle Boot Clamps | for use with Torque Wrench

10  3/8

- forged steel
- suitable for stainless steel hose clamps
- simply adjust to the required torque using a torque wrench on the 10 mm (3/8") socket



Item #
163

Hose Clamp Pliers | for VAG 2.0 TDI

- suitable for new style hose clamps, as built into VAG 2.0 TDI engine
- also suitable for tight spaces
- hose clamp has a locking function and release button



Item #
66120



Pliers for Axle Boot Clamps | 235 mm

- with ear holder, prevents loosening of sleeve fasteners
- universal use, works on CV boots, fuel hoses on VAG, Opel, BMW, Mercedes-Benz, Honda, Nissan, Mazda etc.
- for working on Oetiker system ear hose clamps



Item #
161



Pliers for Ear-Type Clamps | 240 mm

- counterholding tool allows a professional squeezing of ear-type hose clamps, Oetiker system
- dip coated handle



Item #
8359



Pliers for Earless Axle Boot Clamps | 260 mm

- suitable for earless axle boot clamps on rubber and thermoplastic axle boots, installed in Audi, BMW, Chrysler, Ford, GM, Honda, Mazda, Mercedes, Nissan, Opel, Porsche, Volkswagen
- suitable for clamps up to 100 mm diameter, for example Oetiker 168



Item #
9093



Hose Band Tensioning Tool

- for mounting of endless hose bands
- for tensioning and cutting
- is required at e. g. joint & steering boots
- suitable for hose bandwidth up to 10 mm
- with ratchet wrench for better operation
- dip coated handle



Item #
1509



Hose Clamp Tensioning Tool

- for tightening hose clips
- with cutter
- tightening with 13 mm socket possible

Item #
1521



Hose Clamp Screwdriver Set | 6.3 mm (1/4") | 500 mm

6.3 1/4

- incl. 3 sockets 6.3 mm (1/4") drive
- 4 - 5 - 7 mm
- anti-slip 2-component handle
- for hose clamps

Item #
7824



Flexible Hexagon Screwdriver

- for use with 6-pt screws
- mainly for tightening / loosening hose clamps
- anti-slip, ergonomically formed 2-component handle



Item #	Description
7826	Flexible Hexagon Screwdriver 6 mm
7827	Flexible Hexagon Screwdriver 7 mm
7828	Flexible Hexagon Screwdriver 8 mm



Hose Clamp Pliers Set | 155-255 mm | 3 pcs.

- for easy clamping of flexible hose
- adjustable locking ring with locking function for complete stopping of the flow
- the hose is squeezed against the stable surface over a wide area, avoiding damage to the hose
- ideal for maintenance work with petrol, oil, water and anti-freeze
- protects against leakage of petrol, oil, water and antifreeze
- ideally suited for cars, vans, MPVs, commercial vehicles, tractors, agricultural, construction and industrial uses
- temperature resistance of up to 160 °C
- material: special plastic
- hose clamp pliers, 155 mm, suitable for a hose diameter of 3 - 15 mm
- hose clamp pliers, 185 mm, suitable for a hose diameter of 6 - 20 mm
- hose clamp pliers, 255 mm, suitable for a hose diameter of 8 - 45 mm



Pliers



Item #	Description
1815	Hose Clamp Pliers Set 155-255 mm 3 pcs.
1715	Hose Clamp Pliers 155 mm
1716	Hose Clamp Pliers 185 mm
1717	Hose Clamp Pliers 255 mm

Hose Clamp Pliers Set | 90° Angled | 155-220 mm | 3 pcs.

- suitable for a hose diameter of 10,15 and 24 mm
- for easy clamping of flexible hoses
- adjustable locking ring with locking function for complete stopping of the flow
- the hose is squeezed against the stable surface over a wide area, avoiding damage to the hose
- ideal for maintenance work with petrol, oil, water and anti-freeze
- protects against leakage of petrol, oil, water and antifreeze
- ideally suited for cars, vans, MPVs, commercial vehicles, tractors, agricultural, construction and industrial uses
- temperature resistance of up to 160 °C
- material: special plastic
- hose clamp pliers, 155 mm, 90° angled
- hose clamp pliers, 185 mm, 90° angled
- hose clamp pliers, 255 mm, 90° angled



Item #
8764



Hose Clamp Pliers with Locking Mechanism | 220 mm

- for easy clamping of flexible hose
- 45 degrees angled jaws, ideal for reaching into tight spaces
- suitable for hose diameters of up to 32 mm
- automatically locks and holds any position
- quick release function with spring mechanism
- for complete stopping of the flow
- the hose is squeezed against the stable surface over a wide area, thus avoiding damage to the hose
- Ideal for maintenance work with petrol, oil, water and anti-freeze
- protects against leakage of petrol, oil, water and antifreeze
- ideally suitable for cars, vans, MPVs, commercial vehicles, tractors, agricultural, construction and industrial uses
- colour: red, prevents forgetting the tool in the engine bay



Item #
9274



Hose Clamp Pliers Set | 205-305 mm | 3 pcs.

- all metal body
- flexible jaws
- hose clamp pliers max. opening 18 mm, length: 205 mm
- hose clamp pliers max. opening 20 mm, length: 245 mm
- hose clamp pliers max. opening 32 mm, length: 305 mm



Item #
1718



Hose Clamp Assortment | 4 pcs.

- for clamping fuel lines and other plastic hoses
- with swivel metal frame
- 4 sizes for different diameters
- up to Ø 10 - 15 - 25 - 45 mm
- stops fluids within the hose



Item #	Description
1823	Hose Clamp Assortment 4 pcs.
1825	Hose Clamp Ø 10 mm
1826	Hose Clamp Ø 15 mm
1827	Hose Clamp Ø 25 mm
1828	Hose Clamp Ø 45 mm

Hose Line Stopper Set | 8 pcs.

- for locking hoses during maintenance and repairs
- prevents spillage and leakage of operation liquids for e.g. brake hoses, power steering hoses, as well as ingress of dirt
- suitable for hollow screw connections, brake line fittings, quick-action couplings, etc.
- contains 8 line stoppers



Item #
1721

Hose Line Stopper Set | 5 pcs.

- for locking the brake lines and hoses with Banjo fitting during repair jobs
- prevents spillage and leakage of operation liquids
- for brake hoses, air conditioning hoses, power steering hoses
- contains 2 locking pliers and 3 locking clips, suitable for three different hose diameters (internal diameter 5 mm - 6.3 mm - 8 mm)



Item #
1719



Steel Line Stopper Set | 4 pcs.

- for closing brake, fuel and other automotive steel pipes
- fits on e.g. 10 mm (3/8"), 8 mm (5/16") and 12.5 mm (1/2") banjo fittings
- distance of sealing rubber is adjustable
- prevents fluid leaks and contamination during service
- suitable for all automotive fluids



Item #
8705



Fuel Pipe Sealing Plug Assortment | 12 pcs.

- for sealing fuel lines during inspection and service work
- suitable for diesel and petrol lines with push-pull quick connectors
- includes 2 pieces each of the following sizes:
 - plug connector 5/16"
 - plug connector 3/8"
 - plug connector 10 mm
 - quick coupling 5/16"
 - quick coupling 3/8"
 - quick coupling 10 mm

Item #		
9520		



Hose Stripping Pliers | 200 mm

- suitable for tube diameter 4 to 13 mm
- PVC dipped insulated handles
- length: 200 mm

Item #	
486	



Adjustable Hose Remover | Ø 24 - 53 mm

- perfect for removing cooling hoses
- small teeth inside jaws hold even oily hoses firmly

Item #	
492	



Adjustable Hose Remover | Ø 45 - 120 mm

- perfect for removing cooling hoses
- small teeth inside jaws hold even oily hoses firmly
- with cable for more pulling power

Item #
487



Electronic Diagonal Side Cutter | Spring Loaded | 115 mm

- surface finish: nickel plated, matt
- handle type: 2-component handles

Item #
381



Electronic End Cutting Pliers | Spring Loaded | 105 mm

- surface finish: nickel plated, matt
- handle type: 2-component handles

Item #
384

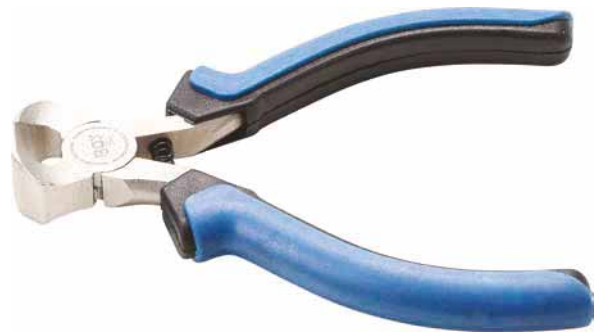

Precision Side Cutter | 115 mm

- especially suitable for electricians
- allows precise cutting of flexible and rigid cables
- suitable for copper cables up to 1.5 mm²
- handle type: 2-component handles

Item #
387



Swedish Diagonal Side Cutter | 165 mm

- surface finish: nickel plated, matt
- handle type: 2-component handles

Item #
393



Diagonal Side Cutters | Stripper function | 165 mm

- surface finish: nickel plated, matt
- handle type: 2-component handles

Item #
394



End Cutting Pliers | 165 mm

- surface finish: nickel plated, matt
- handle type: 2-component handles

Item #		
397		



Heavy Duty Diagonal Side Cutters

- surface finish: nickel plated, matt
- handle type: 2-component handles

	
---	---

Item #	Description
395	Heavy Duty Diagonal Side Cutter 180 mm
396	Heavy Duty Diagonal Side Cutter 240 mm



Double-Joint Side Cutter | 295 mm

- for hard to reach places such as behind interior trim, instrument panel, engine bay, etc.
- even when fully opened, the pliers remain narrow, which allows you to work deep inside
- handle type: 2-component handles

Item #	
533	



VDE Side Cutter | 160 mm

- VDE approved according to DIN EN 60 900:2012
- 2-component anti-slip handle

Item #		
7154		

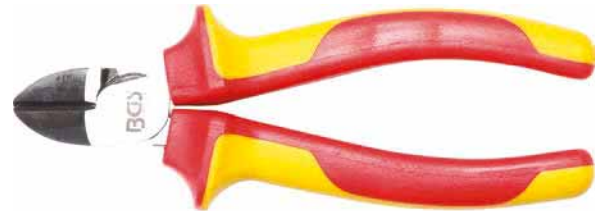

VDE Side Cutter Heavy Duty | 180 mm

- VDE approved according to DIN EN 60 900:2012
- 2-component anti-slip handle

Item #		
7155		



Hand Nibbler | 240 mm

- for burr-free cutting of metal sheets up to 1.2 mm
- also ideal for aluminum, copper and plastic
- no deformation of metal sheets
- clean & exact cutting edges
- with locking function and solid handle

Item #	Description
1605	Hand Nibbler 240 mm
1606	Spare Blade for nibbler



Steel Cable Cutter | 195 mm

- cuts steel cables up to Ø 5 mm
- cuts also spring wires up to Ø 1.5 mm
- SK5 steel blade

Item #
385



Cable Cutter | 450 mm

- for cutting cables
- cutting ability: up to 22 mm diameter (CU)
- cutting heads made of chrome vanadium steel
- special hardened cutting edges (HRC 58 - 62)
- plastic handles

Item #
9298



Mini Bolt Cutter | 200 mm

- suitable for ferrous and non-ferrous metals up to 3 mm
- hardened jaws

Item #
1917



Sheet Metal Roll Shears

- suitable for sheets up to 1.6 mm thickness
- minimal space requirement
- suitable for mounting in a bench vice



Item #
8686

Hose Cutters

- for cutting rubber and plastic hoses
- replaceable blade



Item #	Description
8868	Hose Cutter 4 - 14 mm
8869	Hose Cutter up to 38 mm
8868-1	Replacement Blade For Hose Cutter for BGS 8868
8869-1	Replacement Blade for Hose Cutter for BGS 8869



Hose Cutter with Ratchet Function

- for cutting PVC plastic hoses
- required in electrical installation for cutting of electric tubes / cable ducts
- with ratcheting function
- made of aluminium
- hardened and stainless blades
- for plastic tube Ø up to 35 mm



Item #
1946



Circlip Pliers Set | for small Circlips | 80 mm | 4 pcs.

- particularly suitable in narrow space conditions, e.g. heating mechanics, model construction and small appliance repair
- optimally shaped grips for 2 finger operation
- tip Ø 1 mm
- handle dip insulated
- pliers for internal circlips, straight, 80 mm
- pliers for internal circlips, angled, 80 mm
- pliers for external circlips, straight, 80 mm
- pliers for external circlips, angled, 80 mm

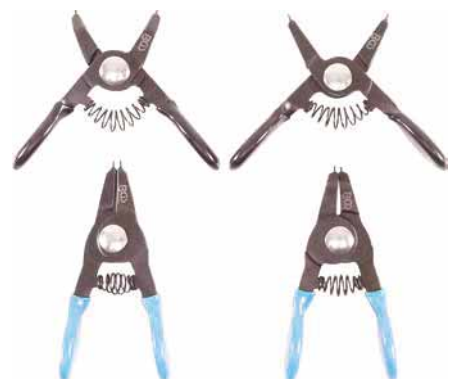

Item #
444



Circlip Pliers Sets

- straight and bent tips
- for internal and external circlips
- non-slip cushion grip handles
- pliers tip \varnothing 1.5 mm
- packed in a solid vinyl wallet

Item #	Description
450	Circlip Pliers Set 150 mm 4 pcs.
447	Circlip Pliers Set 175 mm 4 pcs.
650	Circlip Pliers Set 225 mm 4 pcs.
651	Circlip Pliers Set 300 mm 4 pcs.

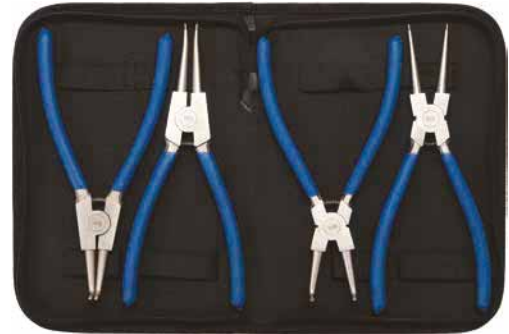

Circlip Pliers Set | Replaceable Tips | 10 pcs.

- for disassembly and assembly of outer- and internal circlips
- pliers for external circlips, self-locking, 265 mm, opening width 7 - 42 mm
- pliers for internal circlips, self-locking, 265 mm, opening width 7 - 44 mm
- interchangeable tips for internal and external retaining rings in the following sizes:
 - \varnothing 2.75 mm, each one pair of 0° / 15° / 45° / 90° angled
 - \varnothing 3 mm, each one pair of 0° / 15° / 45° / 90° angled
- 6 replacement mounting screws
- length: 265 mm

Item #
453



Circlip Pliers Set | for Trucks / Commercial Vehicles | Exchangeable Tips | 400 mm

- one pair of ratchet pliers each for internal and external clips
- for each pair of pliers 3 pairs of exchangeable tips \varnothing 3 mm
- circlips easy to adjust because of the ratcheting function
- for inner circlips from 16 to 80 mm
- for outer circlips from 11 to 73 mm
- for motor trucks and agricultural machines
- pliers for external circlips, 400 mm
- pliers for internal circlips, 400 mm
- 6 replaceable tips, \varnothing 3 mm

Item #
478



Circlip Pliers | for external / internal Circlips | Exchangeable Tips | 180 mm

- reversible, suitable for internal and external snap rings
- replaceable tips
- includes following tips:
 - straight type, Ø 1.8 x 30 mm
 - 90° angled type, Ø 1.2 x 25 mm
- max. opening: 30 mm
- length: 180 mm



Item #	
8831	

Circlip Pliers | for external / internal Circlips | Exchangeable Tips | 180 mm

- reversible, suitable for internal and external snap rings
- replaceable tips
- includes following tips:
 - 2 straight types, Ø 1.8 x 30 mm
 - 2 straight types, Ø 1.2 x 30 mm
 - 2 90° angled types, Ø 1.8 x 25 mm
 - 2 90° angled types, Ø 1.2 x 25 mm
- max. opening: 30 mm
- in foam tray, W190 x D270 x H32 mm



Item #	Description
8831-1	Circlip Pliers for external / internal Circlips Exchangeable Tips 180 mm
8831-2	Spare Steel Tips for Circlip Pliers 4 Pairs for BGS 8831-1

Circlip Pliers | 180 mm

- for the dismantling and assembly of snap rings
- special hardened tips, Ø 1.8 mm
- anti-slip coated handle



Item #	Description
428	Circlip Pliers straight for outside Circlips 180 mm
429	Circlip Pliers angular for outside Circlips 180 mm
432	Circlip Pliers straight for inside Circlips 180 mm
434	Circlip Pliers angular for inside Circlips 180 mm



Circlip Pliers | for external Circlips | 165 mm

- adjustable and exchangeable tips
- straight / 45° / 90°
- insulated handles



Item #	Description
445	Circlip Pliers for external Circlips 165 mm
446	Circlip Pliers for internal Circlips 165 mm



Circlip Pliers | 90° | for external Circlips | 165 mm

- for external clips
- self-opening
- tip length approx. 55 mm
- handle dip insulated

Item #
9539



Circlip Pliers | 90° | for inside Circlips | 165 mm

- for internal clips
- self-opening
- tip length approx. 65 mm
- handle dip insulated

Item #
449



Lock Ring Pliers | 220 mm

- insulated handles
- straight type
- especially for lock / snap rings on axle and gear box shafts
- can be used on lock ring openings larger than 3.65 mm
- surface finish: chrome plated

Item #
530



Pliers

Lock Ring Pliers | 225 mm

- insulated handles
- hooked nose
- especially for lock / snap rings in engine or clutch area
- can be used on lock ring openings larger than 3.8 mm
- surface finish: chrome plated

Item #
531



Circlip Squeezing Pliers | 285 mm

- for squeezing the circlip rings on drive shafts
- facilitates the assembly of universal joints
- suitable for most vehicles such as e.g. VW, Audi, Skoda, Seat, Ford, Mazda, Honda, Mitsubishi, Nissan, Suzuki, Toyota, Opel

Item #
8893



Special Locking Ring Pliers | 215 mm

- for dismantling / installing locking rings without eyelets
- suitable for e.g. wheel bearing locking rings on Citroen
- special design of the plier tips allows easy removing of locking rings
- max. opening width: 41 mm

Item #
8936



E-Ring Circlip Tool Set | "4-IN-1"

- allows easy disassembly and assembly of E-rings
- exchangeable blades with release side and insert side
- suitable for E-ring sizes 6 - 7 - 8 - 9 mm

Item #
9199



Eyelet and Snap Fastener Assortment | 275 pcs.

- in plastic case
- locking pliers
- 18 interchangeable punch and die heads
- eyelets in various sizes
- 10 mm snap fastener for riveting and screwing

Item #	Description
572	Eyelet and Snap Fastener Assortment 275 pcs.
572-LEER	Empty Case for BGS 572



Eyelet and Button Pliers

- for placing eyelets and buttons
- includes 100 eyelets and 25 button sets
- eyelet diameter: external diameter 8 mm, internal diameter 5 mm

Item #
564



Revolving Punch Pliers with Lever Transmission

- punch sizes 2 - 2.5 - 3 - 3.5 - 4 - 4.5 mm
- heavy design
- lever transmission reduces the power needed

Item #
561



Crimping Tool for Cable End Sleeves | incl. 150 Cable Terminals | 175 mm

- crimping pliers for terminal ends
- 40 terminal ends 0.5 x 6 mm
- 40 terminal ends 0.75 x 6 mm
- 30 terminal ends 1.0 x 6 mm
- 20 terminal ends 1.5 x 7 mm
- 20 terminal ends 2.5 x 7 mm

Item #
1430



Stainless Steel Sharp Tip Tweezer | straight | 125 mm

- especially useful for bonding and loosening car wrapping, stickers, etc.



Item #
8620

Upholstery Clip Pliers

- for fixing car seat covers
- spring mechanism holds the clip in the slot of pliers, which facilitates the positioning and squeezing of clamps



Item #	Description
8872	Upholstery Clip Pliers without Clips
8873	Upholstery Clips 100 pcs.

Cable Tie Tensioning Gun | 2.4 - 4.8 mm

- for tensioning plastic cable ties
- cuts cable ties automatically, when the preset adjusted pulling force is reached
- suitable for cable tie widths 2.4 - 4.8 mm
- material: steel



Item #
9368



Soldering Aid Pliers | 240 mm

- for holding cable ends during soldering
- clip springs on the pliers jaws provide a safe grip
- perfect for soldering while working on a car



Item #
9945



Lock Ring Pliers for Drive Shafts

- for assembly of locking rings on driveshafts
- straight, bent and 30° offset type
(available as 3 pcs. set or separately)



Item #	Description
66110	Lock Ring Pliers Set for Drive Shafts 3 pcs.
66105	Lock Ring Pliers for Drive Shafts 30° bent
66107	Lock Ring Pliers for Drive Shafts straight
66109	Lock Ring Pliers for Drive Shafts slightly bent



Electronic Pliers Set | 5 pcs.

- double spring loaded
- with insulated plastic bows
- in a black zipper wallet
- combination pliers 120 mm
- diagonal side cutters 115 mm
- bent nose pliers, straight, 130 mm
- bent nose pliers, bent, 125 mm
- end cutting pliers 105 mm

Item #
463



Long Nose Plier Set | 290 mm | 5 pcs.

- 2-component handles
- in zipper pouch
- long nose pliers 0°, straight
- long nose pliers 20°, angled
- long nose pliers 45°, angled
- long nose pliers 90°, angled
- long nose spark plug pliers

Item #
414



Electronic Combination Pliers | spring loaded | 120 mm

- 2-component handles
- surface finish: nickel plated, matt

Item #
380



Electronic Long Nose Pliers | straight | spring loaded | 130 mm

- 2-component handles
- surface finish: nickel plated, matt

Item #
382



Electronic Long Nose Pliers | bent | spring loaded | 125 mm

- 2-component handles
- surface finish: nickel plated, matt

Item #
383



Electronic Round Nose Pliers | 125 mm

- especially suitable for roll bending of cables and other work in electronics and electric area
- 2-component handles
- with spring mechanism
- straight type
- surface finish: nickel plated, matt

Item #
386



Pliers Set | 3 pcs.

- 2-component handles
- in a black zipper wallet
- surface finish: nickel plated, matt
- long Nose Pliers, straight, 200 mm
- diagonal side cutter, 165 mm
- combination pliers, 175 mm

Item #
358



Needle Pliers | 150 mm

- for bending and shaping and grasping wire
- self opening spring mechanism
- 2-component handles
- surface finish: nickel plated, matt

Item #	CV	
341		



Combination Pliers

- 2-component handles
- surface finish: nickel plated, matt

CV	
----	---

Item #	Description
369	Combination Pliers 165 mm
370	Combination Pliers 175 mm
371	Combination Pliers 200 mm



Flat Nose Pliers | 160 mm

- 2-component handles
- surface finish: nickel plated, matt

Item #	CV	
378		



Long Nose Pliers | straight

- 2-component handles
- surface finish: nickel plated, matt

CV	
----	---

Item #	Description
388	Long Nose Pliers straight 160 mm
389	Long Nose Pliers straight 200 mm



Pliers

Telephone Pliers | 200 mm

- 2-component handles
- surface finish: nickel plated, matt

Item #
373



Double-Joint Pliers | straight Tips | 350 mm

- for hard to reach places such as behind interior trim, instrument panel, engine compartment, etc.
- even when fully opened, the pliers remain narrow, which enables a much deeper work
- 2-component handles

Item #
534



Double-Joint Pliers | offset Tips | 350 mm

- for hard to reach places such as behind interior trim, instrument panel, engine compartment, etc.
- even when fully opened, the pliers remain narrow, which enables a much deeper work
- 2-component handles

Item #
535



Telephone Pliers | extra long | straight Type | 400 mm

- dip insulated handle

Item #
424



End Cutting Pliers | DIN 9243A

- satin black lacquered
- with polished jaws
- PVC dipped handles (blue)



Item #	Description
551	End Cutting Pliers DIN 9243A 180 mm
552	End Cutting Pliers DIN 9243A 200 mm



Mechanic's Pliers | DIN ISO 9242A

- satin black lacquered
- with polished jaws
- PVC dipped handles (blue)



Item #	Description
555	Mechanic's Pliers DIN ISO 9242A 220 mm
556	Mechanic's Pliers DIN ISO 9242A 250 mm
557	Mechanic's Pliers DIN ISO 9242A 275 mm



VDE Pliers Set | 3 pcs.

- VDE approved according to DIN EN 60900
- in zipper storage bag
- 2-componenten anti-slip handles
- combination pliers 180 mm
- wire stripping pliers 160 mm
- side cutters 160 mm

Item #
7158



VDE Combination Pliers | 180 mm

- VDE approved according to DIN EN 60 900:2012
- 2-component anti-slip handles

Item #
7150



VDE Long Nose Pliers | 160 mm

- VDE approved according to DIN EN 60 900:2012
- 2-component anti-slip handles

Item #
7151



VDE Long Nose Pliers | 200 mm

- VDE approved according to DIN EN 60 900:2012
- 2-component anti-slip handles

Item #	CV 
7152	



VDE Long Nose Pliers | Angular | 200 mm

- VDE approved according to DIN EN 60 900:2012
- 2-component anti-slip handles

Item #	CV 
7153	



Water Pump Pliers Set | 3 pcs.

- safety handles
- forged and hardened
- black lacquered finish
- polished jaws and joint
- handles dip insulated
- packed in a tetron wallet
- Waterpump pliers 175 mm, max. opening width: 27 mm
- Waterpump pliers 240 mm, max. opening width: 38 mm
- Waterpump pliers 300 mm, max. opening width: 44 mm



Item #	Description
457	Water Pump Pliers Set 3 pcs.
457-TASCHE	Empty Wallet for BGS 457



Water Pump Pliers Set | 4 pcs.

- safety handles
- forged and hardened
- black lacquered finish
- polished jaws and joint
- handles dip insulated
- packed in a tetron wallet
- Waterpump pliers 175 mm, max. opening width: 27 mm
- Waterpump pliers 240 mm, max. opening width: 38 mm
- Waterpump pliers 300 mm, max. opening width: 44 mm
- Waterpump pliers 400 mm, max. opening width: 80 mm

Item #	CV 
457-2	



Waterpump Pliers | Box-Joint Type

- safety handles
- forged and hardened
- black lacquered finish
- polished jaws and joint
- handles dip insulated



Item #	Description
75110	Water Pump Pliers Box-Joint Type 175 mm
75111	Water Pump Pliers Box-Joint Type 240 mm
75112	Water Pump Pliers Box-Joint Type 300 mm
75113	Water Pump Pliers Box-Joint Type 400 mm



Water Pump Pliers | self-adjusting

- self-adjusting, for "single-handed-use"



Item #	Description
75200	Water Pump Pliers self-adjusting 175 mm
75201	Water Pump Pliers self-adjusting 250 mm



Water Pump Pliers | self-adjusting | 240 mm

- suitable for workpieces up to 48 mm

Item #
75205



VDE Water Pump Pliers | 250 mm

- VDE approved according to DIN EN 60 900:2012
- 2-component anti-slip handles

Item #
7157



Air Impact Wrench Set for Glow Plugs

6.3  1/4

- allows loosening of fixed glow plugs through light impact and twist effect
- can also be used on screws where a low loosening torque is required
- 4-stage torque adjustable to approx. 20 - 30 - 40 - 50 Nm to minimise the risk of tear-off of the glow plugs
- torque setting is possible in forward and reverse mode
- handy due to low weight and small dimensions
- incl. 5 deep sockets in 8, 9, 10, 11 and 12 mm, 1 extension bar and 1 universal joint
- 6.3 mm (1/4") drive
- working pressure 6.2 bar



Item #
3320



Air Impact Wrench | 10 mm (3/8") | Butterfly Type | 135 Nm

10  3/8

- hose connection 6.3 mm (1/4")
- loosening torque 100 Nm, max. torque 135 Nm after 15 seconds
- idle speed 9000 rpm
- forward and reverse butterfly control
- solid and compact finish
- one-hand operation
- air consumption 85 l/min



Item #
3238



Air Impact Wrench Kit | 12.5 mm (1/2") | 1355 Nm | 16 pcs.

12.5  1/2

- 3 protective impact sockets in 17, 19 and 21 mm
- 125 mm extension bar
- 60 mm universal joint
- sockets: 12, 13, 14, 15, 16, 17, 18, 19, 21 and 22 mm
- forward torque (step 1): 580 - 650 Nm
- forward torque (step 2): 745 - 810 Nm
- forward torque (step 3): 950 - 1017 Nm
- reverse torque (step 1): 610 - 678 Nm
- reverse torque (step 2): 950 - 1017 Nm
- max. torque after 15 seconds: 1355 Nm
- working pressure 6.2 bar
- air consumption 153 l/min
- noise level: LpA = 84 dB(A) / LwA = 95 dB(A)
- vibration level: ahd = 4.4 m/s² K = 1.5 m/s²



Item #
5259



Air Impact Wrench | 12.5 mm (1/2") | 1355 Nm

12.5  1/2

- forward torque (step 1): 580 - 650 Nm
- forward torque (step 2): 745 - 810 Nm
- forward torque (step 3): 950 - 1017 Nm
- reverse torque (step 1): 610 - 678 Nm
- reverse torque (step 2): 950 - 1017 Nm
- max. torque after 15 seconds: 1355 Nm
- working pressure 6.2 bar
- air consumption 153 l/min
- noise level: LpA = 84 dB(A) / LwA = 95 dB(A)
- vibration level: ahd = 4.4 m/s² K = 1.5 m/s²
- recommended hose: 10 mm

Item #
3233



Air Impact Wrench | 12.5 mm (1/2") | 1756 Nm

12.5  1/2

- twin hammer mechanism
- max. loosening torque 1756 Nm
- max. working torque 786 Nm
- min. working torque 68 Nm
- 12.5 mm (1/2") square drive
- max. idle speed 8000 rpm
- compressed air inlet: 6.3 mm (1/4")
- recommended hose Ø: 10 mm
- vibration level: ahd = 7.7 m/s² K = 1.25 m/s²
- working pressure: 6.3 bar
- air consumption: 113 l/min
- noise pressure level: = 92.8 dB (A)
- sound power level = 103.8 dB (A)
- length: 187 mm
- weight: 1.9 kg

Item #
9320



Air Impact Wrench | 12.5 mm (1/2") | 1930 Nm

12.5  1/2

- 12.5 mm (1/2") drive
- torque 490 - 1700 Nm
- working pressure 6.2 bar
- air consumption 146 l/min
- compressed air inlet: 6.3 mm (1/4")
- noise level: 91 dB(A)
- vibration: 4.8 m/sec²
- weight: 2.7 kg
- twin hammer mechanism
- length: 184 mm

Item #
3247



Air Impact Wrench | 12.5 mm (1/2") | 949 Nm

12.5 mm 1/2"

- short model, particularly suitable for narrow space requirements
- composite housing
- impact mechanism: twin hammer
- idle speed max: 9000 rpm
- 12.5 mm (1/2") square drive
- min. working torque 610 Nm
- max. working torque 678 Nm
- max. loosening torque 949 Nm
- noise pressure level: 94.2 dB(A)
- sound power level: 105.2 dB(A)
- vibration level: 9.69 m/s² / K=1.5 m/s²
- operating pressure: 6.3 bar
- air consumption: 119 l/min
- hose diameter (recommended): 10 mm (3/8")
- housing length: 110 mm
- weight: 1.3 kg



Item #
3259



Air Impact Wrench | 12.5 mm (1/2") | 880 Nm

12.5 mm 1/2"

- composite housing
- 12.5 mm (1/2") square drive
- max. torque:
 - after 15 seconds: 1110 Nm
 - step 1: 200 Nm
 - step 2: 610 Nm
 - step 3: 880 Nm
- air consumption 139 l/min
- working pressure 6.2 bar
- air inlet: 6.3 mm (1/4")
- hose inside diameter (recommended): 10 mm



Item #
3280



Air Impact Wrench | 12.5 mm (1/2") | 678 Nm

12.5 mm 1/2"

- 12.5 mm (1/2") square drive
- working speed 515 rpm
- max. torque 678 Nm
- max. idle speed 11000 rpm
- working pressure 6.3 bar
- twin hammer impact mechanism
- air inlet: 6.3 mm (1/4")
- recommended hose Ø: 10 mm (3/8")
- weight 1.6 kg
- short, lightweight design
- overall length: 130 mm (incl. 4-pt. drive shaft)
- length: 130 mm



Item #
3245



Air Impact Wrench | 12.5 mm (1/2") | 678 Nm | extra short 98 mm

12.5 mm 1/2"

- light and handy, especially useful when working in confined spaces or when working long hours
- 12.5 mm (1/2") square drive
- max. torque 678 Nm
- max. idle speed 10000 rpm
- working pressure 6.2 bar
- air consumption 0.12 m³/min
- compressed air inlet: 6.3 mm (1/4")
- noise level: 86 dB(A)
- vibration: 2.8 m/sec²
- weight: 1.3 kg
- twin hammer striking mechanism



Item #
3245-1



Air Impact Wrench | 12.5 mm (1/2") | 610 Nm

12.5 mm 1/2"

- square drive 12.5 mm (1/2")
- max. torque 610 Nm
- working pressure 6.3 bar
- air consumption 198.1 l/min
- air connection: 6.3 mm (1/4")
- noise level: LpA = 89.5 db (A) / LwA = 100.5 db (A)
- vibration: ahd = 5.63 m/s² K = 1.05 m/s²



Item #	Description
3246	Air Impact Wrench 12.5 mm (1/2") 610 Nm
3246-7	Drive Shaft for Compressed Air Impact Wrench, BGS 3246 12.5 mm (1/2")

Air Impact Wrench | 12.5 mm (1/2") | 366 Nm

12.5 mm 1/2"

- loosening torque 332 Nm, max. torque 366 Nm after 15 seconds
- air consumption 113 l/min



Item #
3209



Air Impact Wrench Kit | 12.5 mm (1/2") | 366 Nm | 16 pcs.

12.5  1/2

- impact wrench 12.5 mm (1/2")
- quick coupling
- oil pot
- impact extension bar: 125 mm
- 10 impact sockets 9 - 10 - 11 - 13 - 14 - 17 - 19 - 22 - 24 - 27 mm
- loosening torque 332 Nm, max. torque 366 Nm after 15 seconds (320 Nm after 5 seconds)
- air consumption 113 l/min



Item #	Description
3223	Air Impact Wrench Kit 12.5 mm (1/2") 366 Nm 16 pcs.
3223-LEER	Empty Case for BGS 3223

Retaining + O-Ring for Impact Wrench 12.5 mm (1/2")

- suitable for all 12.5 mm (1/2") BGS impact wrenches



Item #
32899

Air Impact Wrench | 20 mm (3/4") | 1756 Nm

20  3/4

- twin hammer mechanism
- max. loosening torque 1756 Nm
- max. working torque 786 Nm
- min. working torque 68 Nm
- 20 mm (3/4") square drive
- max. idle speed 8000 rpm
- compressed air inlet: 6.3 mm (1/4")
- recommended hose Ø: 10 mm
- vibration level: ahd = 7.7 m/s² K = 1.25 m/s²
- working pressure: 6.3 bar
- air consumption: 113 l/min
- noise pressure level: = 92.8 dB (A)
- sound power level = 103.8 dB (A)
- length: 187 mm
- weight: 2.13 kg



Item #
9595



Air Impact Wrench | 20 mm (3/4") | 1600 Nm

20  3/4

- additional handle for better grip
- 20 mm (3/4") square drive
- max. torque: 1600 Nm, 1 step for counter-clockwise rotation, 3 steps for clockwise rotation
- max. air pressure: 6.2 bar
- avg. air consumption: 255 l/min
- max. idle speed 4600 rpm
- air inlet: 10 mm (3/8")
- weight 7.6 kg

Item #
32805



Air Impact Wrench | 20 mm (3/4") | 1355 Nm

20  3/4

- weight: 2200 g
- air consumption 390 l/min
- torque:
 - step 1: 580 - 650 Nm
 - step 2: 745 - 810 Nm
 - step 3: 950 - 1015 Nm
- maximum torque after 15 seconds: 1356 Nm

Item #
3235



Air Impact Wrench | 20 mm (3/4") | 1417 Nm

20  3/4

- compact design for easy handling
- composite housing
- impact type: twin hammer
- idle speed: 8500 rpm
- operating torque: 881 Nm
- max. torque (clockwise direction): 1111 Nm
- max. torque (counter clockwise direction): 1417 Nm
- air consumption: 128 l/min
- working pressure: 6.3 bar
- air inlet size: 63 mm (1/4")
- recommended air hose inner diameter: 10 mm (3/8")
- noise level: 91.5 dB (a)
- vibration level: - 8.1 m/s²
- weight: 2.3 Kg
- length: 200 mm

Item #
3295



Air Impact Wrench | 20 mm (3/4") | 700 Nm

20  3/4

- loosening torque 678 Nm, max. torque 880 Nm after 15 seconds
- recommended air hose inner diameter: 10 mm (3/8")
- operating pressure: 6 - 8 bar
- air consumption 285 l/min



Item #
3225



Air Impact Wrench | 25 mm (1") | 2034 Nm

25  1

- very handy with pistol grip and additional handle
- 25 mm (1") square drive
- max. torque 2034 Nm
- working pressure 6.3 bar
- max. air pressure: 7.0 bar
- avg. air consumption: 200 l/min
- max. idle speed 5300 rpm
- air inlet: 10 mm (3/8")
- recommended hose Ø: 13 mm
- max. sound level: 105.4 db/(A)
- weight: 4900 g



Item #
8497



Air Impact Wrench | 25 mm (1") | 2169 Nm

25  1

- required air pressure 6.2 bar
- air consumption 380 l/min
- max. idle speed 3900 rpm
- torque:
 - step 1: 1288 Nm
 - step 2: 1762 Nm
 - step 3: 2033 Nm
- maximum torque after 15 seconds: 2200 Nm
- weight 14.8 kg



Item #
3240



Air Ratchet Wrenches | 54 Nm | extra short

- very handy and powerful type
- max. torque 54 Nm
- max. air pressure: 6.3 bar
- average air consumption: 110 l/m
- max. idle speed 300 rpm
- air inlet: 6.3 mm (1/4")
- length: 144 mm



Item #	Description
8472	Air Ratchet Wrench 6.3 mm (1/4") 54 Nm extra short
8473	Air Ratchet Wrench 10 mm (3/8") 54 Nm extra short



Air Ratchet Wrench | 6.3 mm (1/4") | 34 Nm

6.3 1/4

- 6.3 mm (1/4") drive
- max. torque 34 Nm
- max. air pressure: 6.2 bar
- average air consumption: 113 l/min
- max. drive speed 265 rpm
- air inlet: 6,3 mm (1/4")
- noise level: LpA = 94.69 dB(A) / LwA = 105.69 dB(A)
- vibration: ahd = 3.54 m/s² K = 1.5 m/s²
- length 175 mm
- weight: 0.6 kg
- length: 175 mm

Item #
3234



Air Impact Wrench | 10 mm (3/8") | 34 Nm

10 3/8

- max. torque 34 Nm
- max. air pressure: 6.2 bar
- max. idle speed 265 rpm
- air inlet: 6.3 mm (1/4")
- length: 175 mm

Item #
3239



Air Ratchet Wrench | 12.5 mm (1/2") | 102 Nm

12.5  1/2

- special long lasting ratchet mechanism
- rubber coated handle
- 12.5 mm (1/2") drive
- max. torque 102 Nm
- max. air pressure: 6.2 bar
- average air consumption: 85.8 l/m
- max. idle speed 180 rpm
- air inlet: 6.3 mm (1/4")
- noise level: LpA = 85 dB(A) / LwA = 95 dB(A)
- vibration: ahd=3.8 m/s² (13.7 m/s² under load)
- weight: 1.3 kg
- length: 265 mm



Item #
3282



Air Ratchet Wrench Set | 12.5 mm (1/2") | 74 Nm

12.5  1/2

- air consumption 113 l/min
- ratchet wrench 12.5 mm (1/2") with right/left switch
- spring-loaded ball bearing, length 250 mm
- 7 impact sockets 9 - 10 - 11 - 13 - 14 - 17 - 19 mm
- 75 mm extension bar
- 1 bit holder 75 mm
- 3 bits



Item #
3224



Air Ratchet Wrench | 12.5 mm (1/2") | 68 Nm

12.5  1/2

- anti-clockwise and clockwise
- ball locking
- max. torque 68 Nm
- operates with 90 PSI
- max. idle speed 150 rpm
- length: 265 mm



Item #
3229



Air Multi-Tool with 3 changeable Working Heads

- quick release for faster and easier change of working heads
- 3 tools in one
- incl. chuck key set
- air quick coupler
- air consumption 115 l/min
- max. pressure: 6.3 bar
- compressed air connection 6.3 mm (1/4")

specific data of grinder:

- max. idle speed 20000 rpm
- chuck size 6.3 mm
- length 215 mm

specific data of ratchet:

- max. idle speed 150 rpm
- 12.5 mm (1/2") drive
- length 278 mm
- max. torque 81 Nm

specific data of drill:

- max. idle speed 2200 rpm
- max. chuck size 9.5 mm

- length: 205 mm



Item #
3262



Air Drill with 10 mm Keyless Chuck

- chuck size: 0.8 to 10 mm
- max. idle speed 1800 rpm
- air consumption: 170 l/min (6 cfm)
- working pressure: 6.3 bar (90 psi)
- air connection: 6.3 mm (1/4")
- recommended hose Ø: 10 mm (3/8")
- length: 197 mm
- weight 1.13 kg
- noise level: LpA = 98 dB(A) / LwA = 101.2 dB(A)
- vibration level: ahd = 4.8 m/s / K = 1.5 m / s



Item #
8852



Air Drill with 10 mm Keyless Chuck

- convenient one-hand operation with side mounted F/R lever
- variable speed throttle for easy start
- with quick action chuck (keyless), suitable for drill diameter up to 10 mm
- composite housing
- length 195 mm
- air pressure 6.2 bar
- air consumption 105 l/min
- max. idle speed 2200 rpm
- compressed air connection 6.3 mm (1/4")
- recommended hose Ø: 10 mm
- weight: 0.9 kg
- noise level: LpA 89.7 dB(A) / KpA 3 dB(A) / LwA 100.7 dB(A) / KwA 3 dB(A)
- vibration: 0.89 m/s² / K 1.5 m/s²



Item #
8965



Air Angle Drill

- suitable for working in confined spaces for e.g. drilling out broken screws on engines, etc.
- chuck size: 10 mm
- air pressure 6.2 bar
- air consumption Ø at 105 rpm
- idle speed 1800 rpm
- compressed air connection 6.3 mm (1/4")
- recommended hose Ø: 10 mm
- length: 195 mm
- power supply: 0.9 kg



Item #
8471



Air Nibbler / Shear for Metal Sheets

- for cutting metal sheets up to 1.2 mm thickness
- cutting speed: 3200 cuts/min
- air pressure: 6.2 bar
- average air consumption 113 l/min
- compressed air connection 6.3 mm (1/4")
- noise level: LpA 79 dB(A) / KpA 3 dB(A) / LwA 90 dB(A) / KwA 3 dB(A)
- vibration: 4.2 m/s² / K 1.5 m/s²



Item #
8956



Air Edge Setter / Hole Punch Pliers

- stamp Ø 5 mm
- punches up to 1.5 mm thickness
- also suitable for stainless steel sheets
- air consumption 113 l/min
- length: 245 mm

Item #
3255



Air Nibbler

- for cutting bodywork metal sheets and aluminium sheets, up to 1 mm thickness
- air consumption 120 l/min



Item #	Description
3237	Air Nibbler
3237-2	Replacement Knife for BGS 3237



Mini Air Jig Saw | low vibration

- strokes per min.: 9000
- stroke: 10 mm
- working pressure: 6.2 bar (90 psi)
- air consumption: 48.2 l/min (1.7 cfm)
- compressed air connection 6,3 mm (1/4")
- recommended hose Ø: 10 mm
- max. material thickness: 1.6 mm steel
- noise level: LPA 77 dB(A), LWA 84 dB(A)
- vibration level: ah 3 m/s² / K=1.5 m/s²
- length: 182 mm
- weight: 0.5 kg

Item #
3400



Air Body Jigsaw

- strokes per min.: max. 9000
- sawing depth 4 cm
- working pressure: 6.3 bar (90 psi)
- compressed air connection 6,3 mm (1/4")
- air consumption: 51 l/min (1.8 cfm)
- 2 saw blades included
- weight: 0.65 kg
- noise level: LpA = 88.15 dB(A) / LwA = 99.15 dB(A)
- vibration level: ahd = 15.06 m/s² K = 1.99 m/s²
- recommended hose Ø: 10 mm (3/8")

Item #
3260-1



Pneumatic Dent Hammer | 1.4 kg

- the hammer creates a vacuum and sucks firmly to the body.
- dents can now easily be removed by working the sliding hammer
- 3 replaceable strainers: Ø 60 mm, 120 mm, 150 mm
- 1400 g sliding hammer weight
- 6.3 mm (1/4") compressed air connection
- air consumption 113 l/min
- working pressure: 6.3 to 10.3 bar (90 to 150 psi) - for best results even with the smallest adaptor an air pressure of min. 10.3 bar is required
- length: 620 mm



Item #	Description
68000	Pneumatic Dent Hammer 1.4 kg
68000-1	Replacement Hose with Valve for BGS 68000
68000-2	Ball Valve for BGS 68000
68000-60	Suction Head for BGS 68000 Ø 60 mm
68000-120	Suction Head for BGS 68000 Ø 120 mm
68000-160	Suction Head for BGS 68000 Ø 160 mm

Air Dent Puller

- suitable for repair of minor dents
- no filling or painting work necessary
- reduces time and cost
- air dent puller with air flow control valve
- foot made from stainless steel, with PVC protection
- pneumatic cylinder with front air exhaust, makes centre shaft movement smooth and helps to cool down the hotmelt glue
- compressed air connection: 6.3 mm (1/4")
- operating pressure: 3 – 10 bar (40 – 145 PSI)
- noise level 6.3 bar: LpA 66.5 db(A) / LwA 77.5 db(A)
- vibration: ahd 0.4 m/s² / K 0.53 m/s²
- incl. 10 dent pads in various sizes / shapes and one extension adaptor



Item #	875
--------	-----



Air Spot Welding Cutter

- with guiding lever
- air consumption 170 l/min
- max. idle speed 1600 rpm
- working pressure 6.3 bar
- air connection: 6.3 mm (1/4")
- incl. 2 drills/cutters Ø 6.5 mm and 2 drills/cutters Ø 8 mm



Item #	Description
3205	Air Spot Welding Cutter
3205-1	Milling Cutter Set for BGS 3205 4 pcs.
3205-2	Lever for BGS 3205

Air Blow Pin | 80 mm

- especially suitable for small spaces
- operated by gently bending the grommet
- good handling

Item #
3278



Air Blow Gun | Aluminum Version | 110 mm

- aluminum finish
- adjustable blow
- with clip holder
- tip outer Ø approx. 5.3 mm

Item #
3210



Air Blow Gun | Aluminium Diecast Body

- material: die-cast aluminium

Item #
3212



Air Blow Gun | Aluminium Pressure Die Casting | with 3 Nozzles

- with 3 nozzles: 25 - 100 - 200 mm
- material: die-cast aluminium

Item #
3215



Air Blow Gun with Flow Regulator

- adjustable air flow
- 110 mm nozzle, optionally usable with plastic scratch protection
- aluminum alloy
- air supply can be attached to handle or top of the gun
- non-slip handle
- includes 6.3 mm (1/4") air connector
- compressed air connection: 6.3 mm (1/4")
- operating pressure: 6.3 bar
- max. operating pressure: 10 bar
- nozzle length: 110 mm
- air consumption: 320 l/min
- noise pressure level: = 86 dB (A)



Item #
8706



Air Blow Gun | with 3 Attachments

- for blowing out, drying, cleaning, etc.
- incl. 3 additional attachment nozzles for: spot jet, round jet, broad jet
- nylon fibre housing
- compressed air connection type: 6.3 mm (1/4")
- length: 100 mm



Item #
9413



Air Blow Gun with Venturi Nozzle

- high air flow but low air consumption
- air flow: 1200 l/min at 15 bar
- compressed air connection: 6.3 mm (1/4")
- working pressure: 10.3 bar
- max. operating pressure 15 bar
- air consumption: 475 l/min
- max. air flow 1200 l/min



Item #
8982



High-Performance Air Blow Gun with Venturi Nozzle | 290 mm

- with long steel pipe for blowing air into tight, confined spaces
- with venturi nozzle for higher air flow
- nozzle length: 290 mm



Item #
8559

Air Blow Gun | 285 - 530 mm

- with extendable nozzle working
- working range: 285 - 530 mm
- for the fast removal and cleaning of chips and other foreign objects
- particularly for use in difficult to access areas on machines and engine compartments
- housing material: plastic
- nozzle material: steel
- compressed air connection: 6.3 mm (1/4")



Item #
9299



Air Blow Guns

- chrome plated seamless steel tube
- blue nylon fibre glass handle
- 6.3 mm (1/4") brass connection



Item #	Description
3208	Air Blow Gun 110 mm
3207	Air Blow Gun 250 mm
3202	Air Blow Gun 330 mm

Twister Gun

- for cleaning heavily soiled surfaces
- suitable for all types of mixing cleaners
- with integrated shut-off valve also suitable for drying after cleaning
- max. operating air pressure: 8.5 bar
- air consumption 310 l/min
- tank capacity: 1 l



Item #	Description
3277	Twister Gun
3277-REP01	Repair Kit for Twister Gun 2 pcs.

Pistol-Grip Air Inflator | calibrated | 0 - 10 bar

- made in Europe, calibrated
- measuring/filling range: 0 - 10 bar
- rubber coated test gauge
- length of hose: approx. 540 mm
- scale diameter 56 mm



Item #
55410



Pistol-Grip Air Inflator | calibrated | 0 - 10 bar

- made in Europe, calibrated
- measuring/filling range: 0 - 10 bar
- rubber coated test gauge
- length of hose: approx. 400 mm
- scale diameter 56 mm



Item #
55400



Pistol-Grip Air Inflator | 0 - 12 bar

- pressure gauge range from 0 to 12 bar, 0.1 bar divisions (0 - 174 PSI, 2 PSI divisions)
- pressure gauge diameter 80 mm
- hose length 540 mm
- tool dimensions (without hose): 230 x 100 x 110 mm
- length: 230 mm
- width: 100 mm
- height: 110 mm



Item #
3242



Pistol-Grip Air Inflator | 0 - 8 bar

- made from aluminium cast iron
- pressure gauge range from 0 to 12 bar, 0.1 bar divisions (0 - 174 PSI, 2 PSI divisions)
- hose length 400 mm
- 270° pressure gauge
- working pressure: max. 8 bar (115 psi)



Item #
3201



Air Inflator | 0 - 11 bar

- air inflator is separated from measuring unit
- pressure gauge is protected by aluminium housing
- offset inflating nozzle
- hose between the inflator and housing coated with protective spring
- pressure gauge scale: 0 - 11 bar
- heavy duty finish, tool weighs approx. 1180 g
- length of tool body approx. 260 mm



Item #
55415



Air Tool Kit

- 1 tire inflator with gauge
- 1 blow gun
- 1 spiral air hose
- 1 air paint spray gun with universal spray head for round, wide and flat jet
- 1 air spray gun for spraying of oil and other liquids
- all tools are made of high-quality aluminium die-cast



Item #
3214



Spare Hose with Adaptor for Air Inflators

- made in Europe
- suitable for BGS 3242, 55400, 55410



Item #	Description
55401	Spare Hose with Adaptor for Air Inflators 0.4 m
55411	Spare Hose with Adaptor for Air Inflators 0.54 m

Spare Hose with Adaptor for Air Inflators | 1 m

- suitable for BGS 3242, 55400, 55410



Item #
3242-1



Retractable Air Hose Reel | Automatic | 15 m

- suitable for mounting on the wall, floor and ceiling
- with hose stop, auto retracting
- air inlet: 6.3 mm (1/4") quick coupling
- air outlet: 6.3 mm (1/4") quick coupling
- maximum pressure air flow 708 l/min
- made of steel sheet
- hose made of PVC
- outside diameter: 17 mm
- internal diameter: 9.5 mm
- max. operating pressure 20 bar
- hose length: 15 m



Item #
8584

Pneumatic Hose Drum | 30 m

- manual rewinding using crank mechanism
- PVC mesh hose
- connecting hose length: 1 m
- both sides of hose with 6.3 mm (1/4") thread
- outside diameter: 12 mm
- internal diameter: 8 mm
- max. operating pressure 20 bar
- hose length: 30 m



Item #
3285



Retractable Air Hose Reel | Automatic | 10 m

- with automatic reel stop, can be unlocked by briefly pulling the hose
- swivel holder
- for wall mounting, with mounting bracket
- hose length 10 m (+ 1.5 m feed line)
- max pressure: 20 bar (300 psi)
- hose material: pvc fabric
- outside diameter: 12 mm
- internal diameter: 8 mm
- compressed air connection: 6.3 mm (1/4")
- max. operating pressure 20 bar
- hose length: 10 m



Item #
3297



Retractable Air Hose Reel | Automatic | 15 m

- with automatic reel stop, can be unlocked by briefly pulling the hose
- swivel holder
- for wall mounting, with mounting bracket
- max pressure: 20 bar (300 psi)
- hose material: pvc fabric
- outside diameter: 18 mm
- internal diameter: 12 mm
- compressed air connection: 6.3 mm (1/4")
- max. operating pressure 20 bar
- hose length: 15 m



Item #
3253



Air Hose | 10 m

- with air quick coupler
- resistant to oil and acid
- outside diameter: 10 mm
- internal diameter: 8 mm
- max. operating pressure 20 bar
- hose length: 10 m

Item #
3130



Air Hose | 10 m

- excellent low temperature flexibility extremely, easy to handle, even in cold weather where other PVC hoses become stiff
- excellent abrasion resistance
- resilient material avoids permanent deformation
- 6.3 mm (1/4") quick coupling
- outside diameter: 15.5 mm
- internal diameter: 9.7 mm
- compressed air connection: 6.3 mm (1/4")
- max. operating pressure 20 bar
- hose length: 10 m

Item #
9087



Air Hose | 10 m

- connector 6.3 mm (1/4")
- max. pressure: 20 bar (290 psi)
- internal diameter: 6 mm
- compressed air connection: 6.3 mm (1/4")
- max. operating pressure 20 bar
- hose length: 10 m

Item #
3250



Spiral Air Hose | 6 m

6.3  1/4

- with bend protection on the couplings
- rotatable and removable coupling adaptor
- made of durable polyurethane
- hose material polyurethane (PU)
- outside diameter: 8 mm
- internal diameter: 5 mm
- max. operating pressure 10 bar
- max. hose length 6 m
- min. hose length 0.9 m
- spiral diameter: 60 mm

Item #
66540



Spiral Air Hose | 6 m

- with 6.3 mm (1/4") air quick coupler
- with bend protection on the couplings
- rotatable and removable coupling adaptor
- hose material polyurethane (PU)
- outside diameter: 12 mm
- internal diameter: 8 mm
- compressed air connection: 6.3 mm (1/4")
- max. operating pressure 10 bar
- max. hose length 6 m
- min. hose length 0.9 m

Item #
66541



Spiral Air Hose | 10 m

- quick release with 6.3 mm (1/4") connection
- hose material polyethylene (PE)
- outside diameter: 10 mm
- internal diameter: 6.5 mm
- hose length: 10 m

Item #
66528



Spiral Air Hose | 10 m

- quick release with 6.3 mm (1/4") connection
- outside diameter: 8 mm
- internal diameter: 6 mm
- compressed air connection: 6.3 mm (1/4")
- hose length: 10 m

Item #
3265



Micro Air Grinder Kit | 17 pcs.

- 54000 rpm
- connection: 6.3 mm
- air consumption 0.143 m³/min
- 6.2 bar air pressure required
- 3 mm drive
- various grinding stones and automatic oiler included

Item #
3249



Die Grinder | short | 170 mm

- heavy and robust air die grinder for universal use - for contour grinding, cutting, polishing, shaping, deflashing and keying
- easy and handy to use
- shank 6 mm
- length: 170 mm
- compressed air connection: 6.3 mm (1/4")
- weight: 600 g
- working pressure: 6.2 bar
- idle speed: 22000 rpm
- air consumption: 127 l/min

Item #
3264



Die Grinder | 90° angled | 155 mm

- 90° angled version
- for contour grinding, cutting, polishing, shaping, deflashing and keying
- capacity: 6 mm (1/4")
- idle speed 18000 rpm
- working pressure 6.2 bar
- air inlet: 6.3 mm (1/4")
- air flow: 99 l/min
- total length: 155 mm
- weight 790 g
- length: 155 mm

Item #
3269



Die Grinder | 340 mm

- extra long type
- for contour grinding, cutting, polishing, shaping, deflashing and keying
- capacity: 6 mm (1/4")
- shaft length: 127 mm
- length: 340 mm
- compressed air connection: 6.3 mm (1/4")
- weight: 1.3 kg
- working pressure: 6.2 bar
- idle speed: 16000 rpm
- air consumption: 170 l/min

Item #
3271



Air Cutter | 75 mm

- handy, short design
- suitable for Ø 75 mm cutting discs, bore diameter: 10 mm, strength: 1.5 mm
- idle speed: 20000 r.p.m.
- air consumption 127 l/min
- working air pressure: 6.3 bar (90 psi)
- connection: 6.3 mm (1/4")
- recommended hose: 10 mm
- dimensions: 185 x 80 mm
- net weight 0.78 kg
- length: 185 mm
- width: 80 mm



Item #	Description
3286	Air Cutter 75 mm
3286-1	Cutting Disc Ø 75 x 1.8 x 9.7 mm

Air Cutter | extra long | 310 mm

- lightweight aluminium housing
- 2-component soft handle
- steel guard spark protection
- trigger safety
- with rear exhaust
- cutting disc size: Ø 75 mm
- cutting disc bore: Ø 10 mm
- working pressure 6.2 bar
- air connection: 6.3 mm (1/4")
- idle speed 18000 rpm
- length: 310 mm



Item #
3287



Air Cutter | extra long | flat Head | 376 mm

- cutting disc Ø 100 mm, adaptor Ø 16 mm
- idle speed: 15000 rpm
- recommended air pressure: 6.2 bar
- air consumption 88 l/min
- air inlet: 6.3 mm (1/4")
- recommended hose length: Ø 10 mm
- noise level: LpA = 85 dB(A) / LwA = 88 dB(A)
- Vibration: K = 0.6 m/s²
- head height including spark protection: 60 mm
- cutting disc available as BGS 3266
- length: 376 mm
- weight approx. 1.4 kg



Item #
3268



Cutting Disc for BGS Reversible Corner Grinder | Ø 105 x 1.5 x 16.2 mm

- suitable for air separation tool BGS 3268
- diameter: 105 mm
- bore diameter: 16.2 mm
- disc thickness: 1.5 mm



Item #
3266

Air Eccentric Angle Sander / Burnisher

- 30, 50 and 70 mm grinding disc holder with M6 x 1.0 shaft
- idle speed: max. 14000 rpm (adjustable)
- length 185 mm
- weight 830 g
- max. working pressure: 6.2 bar
- compressed air connection 6.3 mm (1/4")
- air consumption Ø 122 l/min
- length: 185 mm



Item #	Description
3291	Air Eccentric Angle Sander / Burnisher
3291-30	Hook and Loop Pad for BGS 3291 Ø 30 mm
3291-50	Hook and Loop Pad for BGS 3291 Ø 50 mm
3291-70	Hook and Loop Pad for BGS 3291 Ø 70 mm

Air Grinder

- 150 mm hook and loop tape holder for polishing and grinding discs
- idle speed 10000 rpm
- max. working pressure: 6.2 bar
- compressed air connection 6.3 mm (1/4")
- weight 1900 g
- avg. air consumption: 142 l/min
- length: 225 mm



Item #	Description
3290	Air Grinder
3290-1	Hook and Loop Pad for BGS 3290 / 8688 Ø 150 mm

Air Grinder

- for surface polishing
- with air suction hose and dust bag for collecting the grinding dust
- sanding pad: Ø 152 mm
- free speed: 10000 rpm
- air inlet: 6.3 mm (1/4")
- air suction hose 10 mm (3/8")
- grinding wheel adaptor with 6 suction holes
- air consumption 142 l/min
- working pressure 6.3 bar
- drive shaft thread: M8 x 1.0
- length: 225 mm
- weight: 1.0 kg



Item #
8688



Air Belt Grinder for 10 mm Sanding Belts

- for grinding small surfaces, cleaning brake callipers when replacing the brake pads, etc.
- universally adjustable angle of inclination
- abrasive belt size: 330 x 10 mm
- max. drive speed 20000 rpm
- air consumption 400 l/min
- working pressure 6.3 bar
- compressed air connection 6.3 mm (1/4")
- weight 1.2 kg
- dimensions: 310 x 85 x 50 mm
- max. sound pressure: LpA: = 93 dB(A)
- LwA: = 104 dg(A)
- vibration level: ahd = 4.8 m/s²
- length: 310 mm
- width: 85 mm
- height: 50 mm



Item #	Description
8853	Air Belt Grinder for 10 mm Sanding Belts
8853-1	Grinding Belt 10 mm x 330 mm 12 pcs. for BGS 8853

Airbrush Gun

- adjustable spray pattern
- for 6.3 mm (1/4") air hose
- 1.0 - 3.5 bar
- various accessories: nozzle holder, hose, tanks
- nozzle diameter: 0.35 mm



Item #	Description
3276	Airbrush Gun
3276-1	Empty Case for BGS 3276

Mini Air Paint Spray Gun | 120 cm³

- aluminium body
- chrome plated
- PP cup 120 cm³, with filter
- stainless nozzle (0.8 mm)
- air inlet: 6 mm (1/4")

Item #
3315



Air Paint Spray Gun | 550 cm³

- suitable for painting car and machine parts
- aluminium body
- 550 cm³ cup, with filter
- stainless nozzle (1.4 mm)
- max. pressure: 6 bar
- working pressure 2 to 3 bar
- air consumption 141 - 283 l/min
- noise level: 74.8 db/(A)
- temperature range: 5 - 40 °C

Item #
3317



Air Paint Gun | 500 cm³

- 1.5 mm spray valve
- universal head: round, wide, flat
- air consumption: at 3 bar air flow rate 120 l/min, at 5 bar air flow rate 200 l/min

Item #
3206



Air Paint Spray Gun Set

- perfect for paint repairs and repainting cars, trucks, machinery and other surfaces
- maximum working pressure: 4.8 bar
- recommended operating pressure: 1.4 - 3.45 bar
- aluminium housing
- compressed air connection 6.3 mm (1/4")
- 1 HLVP spray gun for painting small surfaces cup size 125 ml, nozzle size 0.8 mm, weight 230 g
- 1 HLVP spray gun for painting large surfaces cup size 600 ml, nozzle size 1.3 mm, weight 490 g
- 1 pressure regulator with gauge
- 1 cleaning brush
- 1 multifunction wrench



Item #
8381



Air Spray Gun | 1000 cm³

- for detergents and solvents



Item #
3204



Air Spray Gun

- for detergents and solvents
- tank capacity: 1 Liter
- air consumption at 6.2 bar: 113 l/min
- max. pressure: 7.6 bar
- working pressure: 4.8 - 7.6 bar
- compressed air connection 6.3 mm (1/4")



Item #
3220

Air Underbody Coating Gun

- fits on all standard cartridges
- incl. flexible 600 mm air hose



Item #
3203



Spray Gun Cleaning Kit | 24 pcs.

- 3 big brushes of the different lengths
- 5 mini brushes
- 6 micro needles
- 1 brass brush
- 1 large cleaning brush
- 1 plastic bottle with special lubrication fluid for air spray guns
- in a plastic case

Item #
3270



Pneumatic Sand Blasting Cabinet | large

- for sandblasting/cleaning of surfaces with e.g. dry glass beads or plastic granule abrasives
- sealed cabinet with lid and viewing window, mounted gloves and cabinet air filters, to prevent the escape of abrasive material
- saves blasting material, prevents workplace contamination
- includes blasting gun, 4 different nozzles (4, 5, 6, 7 mm) and replaceable protective film for viewing window
- illuminated sand blasting area (230 V)
- working pressure: 4.1 - 8.6 bar
- overall dimensions incl. legs: (W x D x H) 860 x 570 x 1390 mm
- working space: 840 x 550 x 350/550 mm
- weight: 51 kg



Item #
8841



Air Sandblasting Cabinet

- for sandblasting/cleaning of surfaces with e.g. dry glass beads or plastic granule abrasives
- suitable for part size up to 480 x 380 x 260 mm
- sealed cabinet with lid and viewing window, mounted gloves and cabinet air filters, to prevent the escape of abrasive material
- saves blasting material, prevents workplace contamination
- includes blasting gun and 4 different nozzles
- incl. replaceable protective film for viewing window
- illuminated sand blasting area (230V)
- Working pressure 6.2 bar
- dimensions (W x D x H) 585 x 495 x front/rear 415/485
- length: 585 mm
- width: 495 mm
- height: 415 - 485 mm



Item #	Description
8717	Air Sandblasting Cabinet
8717-2	Replacement Gloves for Sandblasting Cabinet for BGS 8717
8717-1	Replacement Sandblasting Gun for BGS 8717

Air Sander

- heavy duty ABS body
- sand container can keep up to 600 cm³,
- can be used with brown aluminum oxide and grain sizes from 46 - 100 (106 bis 425 µm)
- air inlet: 6.3 mm (1/4")
- air consumption 3.3 liter/sec.
- 5 mm steel tip



Item #	Description
3244	Air Sander
3244-1	Spare Steel Tip for BGS 3244

Air Sander

- with 100 cm rubber feeding hose, inner-Ø 10.5 mm
- 6.3 mm (1/4") compressed air connection
- nozzle size: 6 mm
- incl. 6 mm replacement nozzle
- operating pressure: min. 6 bar / max. 8 bar
- air consumption: 425 l/min at 6 bar
- noise level: LpA: 90 dB (A) / LwA: 101 dB (A)



Item #	
8382	

Air Sander Set

- perfect for all applications around the car body and all other metal surfaces
- can be used with brown aluminum oxide and grain sizes from 46 - 100
- for removing old paint, rust, dirt etc.
- 4 different caps included
- reuses the sandblast material, only low consumption
- for 6.3 mm (1/4") air hoses
- working pressure: 3.2 - 9.2 bar
- max. air consumption: 350 l/min



Item #	Description
3243	Air Sander Set
3243-1	Replacement Nozzle for Art. 3243
3243-TASCHE	Sandblast Bag for BGS 3243

Air Window Seal Cutter

- easy removal of glued car windows
- incl. hose and knife
- connection: 6.3 mm (1/4")
- air consumption 113 l/min



Item #
3218



Air Window Seal Cutter

- for cutting out glued vehicle windows
- includes one cutting knife (BGS 3219)
- oscillation: 20,000
- cutting distance: 76 mm
- compressed air connection 6.3 mm (1/4")
- air hose 10 mm
- avg. air consumption: 170 l/min
- working pressure: 6.3 bar (90 psi)
- noise level: LpA= 85 dB(A) / LwA= 96 dB(A)
- vibration level: aH= 10.294 m/s² / K= 1.5 m/s²
- power supply: 860 g



Item #
9291



Cutting Knives Set for Air Window Seal Cutter | for BGS 3218 & 9291 | 7 pcs.

- in different shapes, lengths and widths
- straight, blade length: 35 mm
- offset, blade length: 52 mm
- offset, blade length: 86 mm
- bent, blade length: 16 mm
- bent, blade length: 35 mm
- bent, blade length: 59 mm
- bent, blade length: 86 mm
- drive: 19 mm 12-pt.
- for air window seal cutter BGS 3218 & 9291



Item #	
3256	

Cutting Knife | for BGS 3218 & 9291

- for BGS 3218 & 9291 (Air Window Seal Cutter)



Item #	Description
3258	Replacement Knife, half round for BGS 3218 & 9291 2 x 36 mm 2 pcs.
3257	Cutting Knife, half round for BGS 3218 2 x 24 mm 2 pcs.
3219	Cutting Knife for BGS 3218 & 9291 52 x 1 mm



Air Spray Bottle | Aluminium | 650 ml

- ideal for spraying e. g. cleaner (brake cleaner), rust converter & anti rust liquids
- 2 adjustable spray jet patterns:
 1. folded-in nozzle needed for wide spray jet
 2. folded-out nozzle needle for narrow spray jet
- long nozzle needle is particularly suitable for narrow areas which are difficult to access
- aluminium bottle, designed for long service life
- universal filling valve (Schrader valve) for easy compressed air filling
- safety valve prevents applying excessive pressure
- max. operating pressure: 6.3 bar (90PSI)
- max. filling capacity: 650 ml
- operating capacity: 50 - 350 ml



Item #	Description
9393	Air Spray Bottle Aluminium 650 ml
9393-1	Spare Nozzle for Spray Bottle for BGS 9393

Catalytic Converter Pressure Cleaner

- for injecting detergent into the catalytic converter & diesel particle filter
- universally applicable for all models
- stainless steel tank
- aluminium base for secure stand
- working pressure range: 3 - 7 bar
- max. filling capacity: 650 ml
- hose material: nylon
- hose diameter: 4 x 6 mm
- hose length: 2.7 m

Item #
9417



CV Boot Air Assembly Tool | 25 - 115 mm

- material: aluminium
- expanding range: 25 - 115 mm
- Compressed air connection: 1/4"

Item #
162



Foam Gun for cartridges

- for PU foam
- adjustable foam flow
- tube length: 200 mm

Item #
3267



Air Riveter

- suitable for aluminium rivets in sizes 2.4 - 3.2 - 4.0 - 4.8 mm
- pulling power: 720 kg
- air consumption 0.86 l/min
- stroke length: 14 mm
- compressed air connection 6.3 mm (1/4")
- working pressure 6.2 bar

Item #
3284



Air Caulking Gun | for 310 ml Cartridges

- for permanent sealing materials, adhesive paste, groove sealants etc.
- for paper, aluminium and plastic cartridges
- with pressure release, avoids material leakage of the sealing compounds
- controller for quantity adjustment



Item #
3514



Air Grease Gun | 400 cm³

- volume: 400 cm³
- incl. flexible and rigid delivery tubes
- 6.3 mm (1/4") compressed air connection
- working pressure: 6.2 bar (90 psi)
- noise level: LpA = 85.1 dB(A) / LwA = 96.1 dB(A)
- vibration level: ahd = 0.51 m/s² K = 0.55 m/s²



Item #	Description
3236	Air Grease Gun 400 cm ³
3236-1	High-Pressure Hose Made of Flexible Nylon for BGS 3236

Air Hammer Kit | for 10 mm round Chisel | 7 pcs.

- suitable for work on car body and for mechanics
- plastic coated air hammer
- 4 chisel with different profiles
- quick release head
- strokes per min.: 3.500
- air consumption: 179 l/min
- chisel shank: round, 10 mm
- stroke: 67 mm
- working pressure 6.2 bar
- air connection: 6.3 mm (1/4")
- especially for use with vibro chisel set BGS 8436
- length: 170 mm
- weight: 1.6 kg



Item #
3515



Air Needle Scaler

- ideal for removing rust and paint
- stroke: 3500 bpm
- max. pressure: 6.2 bar
- air consumption 198 l/min
- air inlet: 6.3 mm (1/4")
- length: 330 mm
- weight: 1.9 kg



Item #	Description
8540	Air Needle Scaler
8540-1	Repair Kit for BGS 8540

Pneumatic Fuel Suction Device | 40 l

- for extracting gasoline and diesel fuel
- allows an easy emptying of tanks, fuel pumps, tank sensors or emptying wrongly filled tanks
- 3 suction tubes Ø 6 - 8 - 10 mm, 2 m long
- suction power: 5 l/min
- working pressure: 5 - 8 bar
- air consumption 170 l/min
- compressed air connection 6.3 mm (1/4")



Item #
8702



Air Multi-Functional Tool "3-IN-1"

- versatile 3-in-1 air tool: delta sander - saw - scraper
- powerful operation due to the high vibration
- perfect for working in hard to reach areas and close to corners
- triangular sanding pad: 76 mm (3"), 45°
- working pressure 6.2 bar
- air inlet: 6.3 mm (1/4")
- max. oscillations: 18000 bpm
- air consumption 170 l/min
- noise LpA = 86 dB(A) / LwA = 97 dB(A)
- vibration: 3.62 m/s²



Item #	Description
8580	Air Multi-Functional Tool "3-IN-1"
8580-1	Saw Blade straight for BGS 8580
8580-3	Knife / Scraper Set for BGS 8580
8580-4	Saw Blade offset for BGS 8580
8580-5	Abrasive Pad Holder for BGS 8580



Combination Air Nailer | 50 mm

- suitable for brads 10 - 50 mm (18GA) and narrow crown staples 10 - 40 mm (18GA)
- air inlet: 6.3 mm (1/4")
- working pressure range: 4 - 8 bar
- max. pressure: 8.3 bar
- air consumption: 1.4 l/min (at 4 bar)
- noise level: LpA = 79.9 dB(A) / LwA = 92.9 dB(A)
- max. magazine capacity 100 pcs.
- power supply: 1.5 kg



Item #
32801



Pneumatic Special Oil | 100 ml

- recommended for all BGS air tools (regular lubrication guarantees high performance in daily use)
- for increasing machine service life
- with cap



Item #
9460

Needle scaler Head | 10 mm round shank

- for all pneumatic chisels with 10 mm round shaft
- ideal for removing rust and paint
- length 230 mm



Item #
3515-1

Impact Chisel Set

- ideal for loosening rusty bolts and components
- chisels have different profiles to facilitate dismantling and protect the surface of components
- using these tools has a rust-removing effect and ensures deep entering of rust removers
- suitable for ball joints, bearings, bushings, sleeves etc.
- for all air chisels with 10 mm hexagon and round adaptor, e.g. BGS 3515



Item #
8436

Air Hammer Drift Set | 6 pcs.

- allows the extraction of shafts, screws, etc. if stuck in deep holes
- includes the six most commonly used sizes: 5.2 - 6.5 - 6.9 - 7.7 - 9.3 and 12.7 mm
- round shaft, Ø 10 mm
- length: 177 mm

Item #
8943



Hammer Set for Air Impact Hammers | 4 pcs.

- for working on sheet metal parts
- suitable for sensitive surfaces, e.g. aluminium body parts
- includes hammer heads made of nylon, copper, aluminum and polished steel
- 10 mm round shank

Item #
9002



Air Hammer Chisel Set | 5 pcs.

- for using with air hammer (e.g. BGS 3515)
- includes the following chisels:
 - straight chisel
 - spot weld chisel
 - pipe cutting chisel
 - edging chisel
 - taper punch
- 10 mm round shank
- material: manganese steel (65)

Item #
9182



Exhaust Pipe Chisel for Inner Pipes

- length: 200 mm
- chisel width 30 mm
- material: steel (SCM440)
- drill shaft diameter: 10 mm

Item #
9179



Exhaust Pipe Chisel for Outer Pipes

- length: 200 mm
- chisel width 30 mm
- material: steel (SCM440)
- drill shaft diameter: 10 mm

Item #
9180



Impact Loosening Lever for Air Hammers

12.5  1/2

- for loosening tightly fitted screw connections
- suitable for e.g. air hammer BGS 3515 and other air hammers with 10 mm shafts
- 100 mm lever with 12.5 mm (1/2") square drive
- 560 mm impact shaft

Item #
25151



Air Pressure Regulator | 0.275 - 11 bar

- continuously variable from 0.275 to 11 bar
- protects air tools by reducing the air pressure from the compressor
- can be mounted directly on the air tool or connected to the compressor / air distributor
- dimensions: 33 x 45 x 55 mm

Item #
3263



Air Filter / Oiler Unit with Pressure Regulator

- for filtering and oiling of compressed air
- can be screwed on a wall
- max. pressure: 15 bar
- air inlet and outlet: 6.3 mm (1/4")
- pressure gauge adjustable 0 to 10 bar
- oil adjustable in 10 steps

Item #
8603



Exhaust Air Hose for Air Tools | 530 mm

- keeps dirt air away from the car
- lowers the noise level
- air inlet and outlet: 6.3 mm (1/4")

Item #
68010



Air Plug | 6.3 mm (1/4")

- wear part for pistol-grip air inflators e. g. BGS 3201, 55400, 55410
- fixed with hose clamp (not included)

Item #
68012



Automatic Air Oiler | Hose Connection 6.3 mm (1/4")

Item #
3241



Air Rotary Connector

- can be used with e.g. air safety quick coupler BGS 9288 and BGS 9289
- air connecting thread: 6.3 mm (1/4")

Item #
9377



Air Safety Quick Coupler | 2-Step Loosening Function | 6,3 mm (1/4") Female Thread

- prevents "flyaway" of the coupling when unlocked
- 2-step uncoupling of the air tools
1. step: coupler is loosened, air can escape, quick coupler remains fixed to the air tool
 2. step: quick coupler can now safely be disconnected from air tool

Item #
9288



Air Safety Quick Coupler | 2-Step Loosening Function | 6,3 mm (1/4") Male Thread

- prevents "flyaway" of the coupling when unlocked
- 2-step uncoupling of the air tools
1. step: coupler is loosened, air can escape, quick coupler remains fixed to the air tool
 2. step: quick coupler can now safely be disconnected from air tool



Item #
9289

Air Nipple | 6.3 mm (1/4") external Thread

- for various air tools

Item #
3222



Air Nipple | 6.3 mm (1/4")

- suitable for most pneumatic tools of small and medium sizes
- external thread: 6.3 mm (1/4")

Item #
3222-1



Air Thread Coupler | 6.3 mm (1/4") internal Thread

- for air hoses
- ball headed joint
- 360° turnable

Item #
3227



Air Thread Coupler | 6.3 mm (1/4") external Thread

- for air hoses
- ball headed joint
- 360° turnable

Item #
3228



Air Quick Coupler

- brass
- for air hoses
- 6 mm long hose nozzle

Item #
3226



Air Quick Coupler with 8 mm Hose Connection

- fits on most pneumatic tools of small and medium sizes
- is required for connecting hoses

Item #
3226-1



Air Nipple with 8 mm Hose Connection

- fits on most pneumatic tools of small and medium sizes
- is required for connecting hoses

Item #
3222-2



Air Nipple with 10 mm Hose Connection

- fits on most pneumatic tools of small and medium sizes
- is required for connecting hoses

Item #
3222-3



Air Nipple | 10 mm (3/8")

- fits on most pneumatic tools of small and medium sizes
- external thread: 10 mm (3/8")

Item #
3222-4



Multi-Function Jump Starter | 10,800 mAh

- emergency battery booster for gasoline engines up to 5.0 l diesel engines and up to 3.0 l engine capacity
- 5V voltage source for charging USB devices, such as smartphones, tablets, etc. with mini USB socket, micro USB socket, Apple "Lightning" and 30-pin Apple connector
- 12 / 16 / 19V voltage source for charging laptops, etc.
- very handy, powerful device
- small dimensions: 160 mm x 71 mm x 31 mm
- display for: battery capacity in % voltage and current on 12 / 16 / 19V bus voltage and current on USB bus
- battery capacity: 10.800 mAh (37 W/h)
- starting current: 200A, top 400A (3s)
- USB-output: 5V / 0.1 up to 3A
- voltage output: 12V / 16V / 19V
- automatic shut-off (approx. 15 sec.)
- includes the following accessories:
 - 1 battery booster
 - 1 cable with jump leads
 - 1 USB adaptor charging cable
 - 1 laptop charging cable
 - 8 charging cable adaptors (DC connector)
 - 1 car charging cable
 - 1 charger, 110-240V / 15V(1A)



Item #
9190



Plastic Repair Kit | cordless

- for repairing cracks in plastic parts thicker than 1 mm
- suitable for plastic with max. 40% glass fiber content
- suitable for plastic bumpers, panels, brackets, etc.
- this tool heats up the clamps to a temperature between 100 and 200° C so that they can connect the breaking points and bring back material stability
- can also be used for enforcing strongly used areas in plastics
- includes: heating unit, charger, battery, V-shaped repair clamps 0.6 mm and U-shaped repair clamps 0.6 mm, 0.8 mm



Item #
868



Plastic Repair Set

- for repairing cracks in plastic parts thicker than 1 mm
- suitable for plastic with max. 40% glass fiber content
- suitable for plastic bumpers, panels, brackets, etc.
- includes repairing clamps in V-shape 0.6 mm, U-shape 0.6 mm and U-shape 0.8 mm
- this tool heats up the clamps to a temperature between 100 and 200° C so that they can connect the breaking points and bring back material stability
- can also be used for enforcing strongly used areas in plastics



Item #	Description
873	Plastic Repair Set
873-1	Repair Staples U-Type Ø 0.6 mm 100 pcs.
873-2	Repair Staples U-Type Ø 0.8 mm 100 pcs.
873-3	Repair Staples V-Type Ø 0.6 mm 100 pcs.

Cordless Caulking Gun | Li-Ion | 10.8 V

- durable industrial seal gun for silicone, acrylic, grease, assembly adhesives, etc.
 - with 10.8 V LI-Ion battery
 - additional batteries available under BGS 9916
 - suitable for 400 ml cartridges or bags
 - allows quick and clean application
 - automatic reverse function avoids pressure in the system and prevents the leakage of liquids
 - adjustable feed speed from 1 - 5.0 mm/s
 - gear rack pushing bar
 - one battery charge allows processing of multiple silicone cartridges
 - thrust power: 450 kg
 - dispensing gun weight: 2.2 kg
- dispensing gun
 - battery
 - battery charger



Item #
8496



Hot Air Gun | 2000 W

- 2 temperature steps, 400° C / 600°C

suitable for:

- shrinking of shrink down tubing and packaging material
- soldering of non insulated cables and cable lugs
- loosening of uninsulated solder joints
- forming and welding of plastics
- drying of surfaces
- acceleration of adhesive processes
- de-frosting of icy stairs, steps, door locks, etc.
- removing old paint
- disinfection of surfaces
- heating of engines and transmission parts for assembly

- capacity: 2000 W
- power supply voltage (AC) 230 V
- feed line: 1,8 m



Item #
8495



Digital Electronic Soldering Station

- ideal for electricians, schools, car electricians and for development and production
- soldering iron holder and cleaning sponge
- digital LCD temperature display simultaneously shows the set and actual temperature
- compact design
- electronic temperature control
- reaches set temperature after a short time
- secure, low operating voltage on soldering iron
- temperature pre-selection by 200°, 300°, 400° buttons, fine adjustment is done via + and - buttons
- conversion button for switching the unit from °C to °F
- potential equalization socket for protecting sensitive components
- error is shown on the display and by an acoustic signal
- power supply: 220 to 240 volts / 50 Hz
- fuse: T1 A/250 V 50 x 20 mm glass tube
- temperature range: 150° C to 450 ° C
- soldering iron power: 48 Watt (24 V)
- temperature display: LCD display 2x 3 ½ digits
- display area: 150 ° C to 450 ° C
- accuracy: 5% air pressure: 600 hPa to 1000 hPa
- working temperature range: +5 ° C to +40 ° C
- relative humidity: 85%
- weight approx. 1.8 kg
- tool dimensions: 210 x 125 x 135 mm
- length: 210 mm
- width: 125 mm
- height: 135 mm



Item #
8612



Cordless Drill | max. 800 rpm | Li-Ion | 10.8 V

- 10.8 V (DC) handy cordless drill driver
- cordless drill machines
 - no-load current: 2.2 A
- battery charger
 - for gentle charging at all charging stages
 - charging time: approx. 1 hour (with automatic shut-off)
- 2 Li-Ion batteries
 - low self discharge
 - suitable for quick charging
 - powerful and durable
- max. torque: 11 Nm
- battery charging time: 1 h
- battery voltage 10.8 V
- battery type: Li-Ion
- idle speed: 0 - 800 rpm
- weight (without Li-Ion battery pack): 0.75 kg



Item #
9931



Cordless Polisher and Grinder Set | in Tool Tray for Workshop Trolleys | 10.8 V | 8 pcs.

- suitable for daily heavy-duty workshop use
- polisher:
 - speed: 3000 rpm
 - torque: 34 Nm
 - power supply: 875 g
- grinder:
 - speed: 22000 rpm
 - torque: 62 Nm
 - power supply: 805 g
 - hook and loop plate: 73 mm
- worklight:
 - brightness: 160 / 35 Lux
 - operation time: 9 / 35 h
 - weight: 433 g
- Li-Ion battery
 - voltage: 10.8 V
 - charging time: 1 hour
 - weight: 185 g
- tray size: 285 x 405 mm (1/2 drawer)
- replacement battery Li-Ion available as BGS 9916
- replacement charger available as BGS 9917
- includes the following tools:
 - 1 polisher
 - 1 grinder
 - 1 worklight
 - 2 high-performance batteries
 - 1 electronically controlled charger for gentle charging at any charging stage with automatic shut-off
- battery charging time: 1 h
- battery voltage 10.8 V
- battery type: Li-Ion



Item #
4019



Replacement Battery | Li-Ion | 10.8 V

suitable for:

- Li-Ion battery ratchet BGS 4018
- Li-Ion battery polisher and grinder set BGS 4019
- Li-Ion battery cordless drill BGS 9931
- Li-Ion battery cordless caulking gun BGS 8496

- battery voltage 10.8 V
- battery type: Li-Ion



Item #
9916



Cordless Polisher | max. 3.000 rpm | 10.8 V | 1.3 Ah

- for polishing of small surfaces
- electronic speed control, variably adjustable
- free-load speed 1.500 – 3.000 rpm
- pad diameter Ø 100 mm
- shaft thread M10
- machine weight: about 820 g
- noise level LpA 71 dB(A), KpA 3 dB(A), LwA 82 dB(A), KwA 3 dB(A)
- vibration level aH= 2.68 m/s², K= 1.5 m/s²
- battery: Li-Ion 10.8 V / 1.3 Ah
- charger input voltage 100 - 240 V AC, 50 - 60 Hz, 30 W



Item #	Description
9259	Cordless Polisher max. 3.000 rpm 10.8 V 1.3 Ah
9259-1	Replacement Battery Li-Ion 10.8 V / 1.3 Ah for BGS 9259
9259-2	Quick Charger for BGS 9259
9259-3	Sanding Plate with Hook and Loop Ø 100 mm for BGS 9259
9259-4	Dusters Ø 100 mm 3 pcs. for BGS 9259
9259-5	Sanding Plate with Hook and Loop Ø 80 mm for BGS 9259
9259-6	Dusters Ø 80 mm 3 pcs. for BGS 9259

Cordless Angle Grinder | 7.000 rpm | 20 V | 1.5 Ah

- for cutting and grinding
- powerful, lightweight and well-balanced
- cutting disc size: 115 mm
- max. drive speed 7000 rpm
- dimensions (case): 355 x 130 x 300 mm
- machine weight: about 1.5 kg
- weight with case: about 3.8 kg
- noise level: LPA 76.2 dB(A), LWA 87.2 dB(A)
- vibration level: ah = 4.272 m/s² (K = 1.5 m/s²)
- battery: Li-Ion 20V / 1.5 Ah
- charger: 230 V AC, 50 Hz



Item #	Description
9258	Cordless Angle Grinder 7.000 rpm 20 V 1.5 Ah
9258-1	Replacement Battery Li-Ion 20 V / 1.5 Ah
9258-2	Quick Charger for cordless angle Grinder 230 V for BGS 9258

Soldering Iron | 60 W

- suitable for soldering of up to 6 mm² cables
- flat, coated tip



Item #
9948



Automatic Cable Reel | 15 m

- with automatic reel stop, can be unlocked by briefly pulling the cable
- swivable holder
- for wall mounting, with mounting bracket
- cable diameter 3 x 1.5 mm²
- cable length 15 m + 1 m feed line
- voltage suitable for 230 V
- dimensions: 295 x 165 x 330 mm
- length: 295 mm
- width: 165 mm
- height: 330 mm
- weight: 4.5 kg



Item #	Description
3321	Automatic Cable Reel 15 m
3321-1	Mounting Bracket for Automatic Cable Reel BGS 3321

Cordless Impact Wrench | 520 Nm | max. 2.000 rpm | 18 V

12.5  1/2

- for loosening and tightening of screws and nuts, esp. wheel nuts
- 18V li-ion battery for long operation time and high power
- rated voltage: 18V DC
- rated speed: 0 - 2.000 rpm
- rated impact: 0 - 3.200 bpm
- drive: 12.5 mm (1/2") square
- max. torque: 520 Nm
- noise level:
 - LpA: 99.6 dB(A) K= 3dB(A)
 - LwA: 110.6 dB(A) K= 3dB(A)
- vibration level: ah: 17.95 m/s² K=1.5 m/s²
- battery pack: 18V / 4.000 mAh Li-Ion
- mains charger:
 - input 100-240V AC / 50Hz / 75W
 - output 18V DC / 2.500 mA
- charging time: 100 min
- delivered in a handy carrying case



Item #	Description
9919	Cordless Impact Wrench 520 Nm max. 2.000 rpm 18 V
9923	Replacement Battery for Cordless Impact Wrench BGS 9919
9924	Quick Charger for Cordless Impact Wrench BGS 9919
9919-REP01	Repair Kit "Hammer Mechanism" for Cordless Impact Wrench BGS 9919
9919-REP02	Repair Kit "Motor" for Cordless Impact Wrench BGS 9919
9919-REP03	Repair Kit "Housing" for Cordless Impact Wrench BGS 9919

Induction Heater

principle of operation:

- there is an alternating magnetic field, the metallic object (e.g. nut), in the induction coil, acts on the induced eddy currents as an electrical resistance and thus heats up.
- allows heating of screws/nuts without heating surrounding components too much or even destroying them, as it is often the case when heated with a torch
- within the shortest possible time, e.g. rusty nuts are heated and can be loosened
- using for e.g. ball joint pinch bolts and other items on axle and engine
- a formless coil (length: 800 mm) allows using the device also for heating of components (bearings, etc.) e.g. bearings in which the heating facilitates disassembly or assembly
- includes the following induction coils
 - induction coil: 19 mm, length: 220 mm (for Ø 10-16 mm)
 - induction coil: 27 mm, length: 220 mm (for Ø 17-24 mm)
 - induction coil: 50 mm, length: 235 mm (for heating small surfaces)
 - formless coil, 780 mm, for heating of components
- max. power: 1.5 kW
- max. current: 7.5 A
- length: 200 mm
- width: 140 mm
- height: 75 mm
- power supply: 4.5 kg
- power supply frequency 50 - 60 Hz
- power supply voltage (AC) 230 V
- protection class IP 20



Item #
2169



Induction Coil Set for Induction Heater | angled 90° | for BGS 2169 | 8 pcs.

- for heating screws, nuts, shafts, etc.
- suitable for induction heater BGS 2169
- angled 90° type
- wire diameter: 4 mm
- coil height: approx. 23 mm
- length approx. 220 mm
- includes coils with the following internal diameters
15 - 19 - 20 - 23 - 26 - 32 - 38 - 45 mm

Item #	Description
2169-1	Induction Coil Set for Induction Heater angled 90° for BGS 2169 8 pcs.
2169-4	Induction Coil for Induction Heater 19 mm angled 90° for BGS 2169
2169-6	Induction Coil for Induction Heater 25 mm angled 90° for BGS 2169
2169-1-32	Induction Coil for Induction Heater 32 mm angled 90° for BGS 2169
2169-1-38	Induction Coil for Induction Heater 38 mm angled 90° for BGS 2169
2169-1-45	Induction Coil for Induction Heater 45 mm angled 90° for BGS 2169



Induction Coil Set for Induction Heater | straight type | for BGS 2169 | 8 pcs.

- for heating screws, nuts, shafts, etc.
- suitable for induction heater product 2169
- straight type
- wire diameter: 4 mm
- coil width: approx. 23 mm
- length approx. 230 mm
- includes coils with the following internal diameters
15 - 19 - 20 - 23 - 26 - 32 - 38 - 45 mm



Item #	Description
2169-2	Induction Coil Set for Induction Heater straight type for BGS 2169 8 pcs.
2169-2-32	Induction Coil for Induction Heater 32 mm straight type for BGS 2169
2169-2-38	Induction Coil for Induction Heater 38 mm straight type for BGS 2169
2169-2-45	Induction Coil for Induction Heater 45 mm straight type for BGS 2169

Induction Wires for Induction Heater | for BGS 2169

- suitable for heating screws, nuts, shafts, etc.
or for heating of metal sheets (body parts)
- suitable for induction heater BGS 2169
- wire diameter: 4 mm

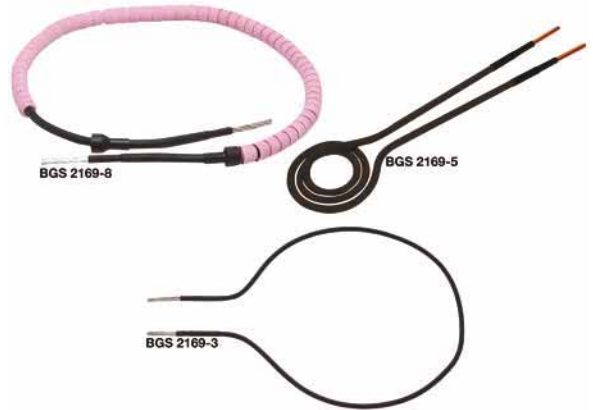

Item #	Description
2169-3	Induction Wire for Induction Heater for BGS 2169
2169-5	Induction Coil for Induction Heater flat for BGS 2169
2169-8	Induction Coil for Induction Heater with ceramic protection for BGS 2169

Induction Coil, for Induction Heater | for small surfaces | for BGS 2169

- allows a pinpoint heating
- especially suitable for heating of components which are difficult to access e.g. bearing rings in gearboxes, etc.



Item #
2169-9

AUTOMOTIVE TOOLS

435

Speciality Tools Motorbike	436
Speciality Tools SUV and Trucks	456
Speciality Tools Car	464
Brake	464
Electrics	491
Gearbox / Axle / Steering	500
Car Body / Interior	555
Cooling System / Heating / Air Conditioning	591
Engine & Attachments	594
Workshop Equipment	754
Container / Funnel / Pumps	754
Leverss / Cross Beams / Cranes	758
Hydraulic	763
Caulking Guns & Grease Guns	764
Lights	767
Magnetic Lifters, Pick-up Tools & Mirrors	772
Mounting Levers, Pry Bars	777
Oil service	778
Test Devices	809
Tyre Service	834
Cleaning Devices	846
Creepers, Knee Pads and Protective Pads	847
Consumables	852
Floor Jacks & Axle Stands	890
Workshop Presses	894
Car Accessories	895

Visit www.bgstechnic.com for updates.

Subscribe to our Newsletter at www.bgstechnic.com and be the first to find out about new items in our product range.

Tyre Lever with Aluminium Handle | for Motorcycles | 390 mm

- rounded edges
- ideal size for comfortable working
- aluminium handle for extra convenience - no fatigue limit !
- surface finish: chrome plated

Item #
1528



Tyre Lever | for Motorcycles | 370 mm

- plastic handle
- surface finish: chrome plated

Item #
1529



Spring Compressor Set | for Motorcycles | 2 pcs.

- facilitates assembly of springs on the spring strut
- max. opening width: 100 mm
- 3/8" and 17 mm drive
- rubber protection on the tensioning claws prevents damage to the spring coating
- made from high grade steel
- housing material: stainless steel
- suitable for cylindrical springs with a wire diameter up to 11 mm

Item #
991



Spring Tensioner | for Upside-Down Forks

- helps to save time, one-man operation
- for pre-tensioning of fork springs
- suitable for most common Upside-Down forks
- 340 to 800 mm clamping range
- made for springs up to 2350 N
- length 570 mm

Item #
1174



Spring Compressor Set | for Harley Davidson

- two sets in one: suitable for 39 mm and 41 mm front fork springs
- includes pre-clamping pieces for assembly of fork caps
- special socket for disassembly and assembly of fork cap
- 195 mm long clamping spindle with a diameter of 18.6 mm



Item #
992

Bit Set | for Motorcycles | internal Hexagon 10 mm (3/8")

12.5 \square 1/2

- is required when working on motorcycle axles and forks
- adaptor with retaining ball
 - 12.5 mm (1/2") drive
- bit sizes: 17 - 19 - 22 - 24 mm, 10 mm (3/8") shank



Item #
5060

Motorcycle Special Socket | 10 mm (3/8") | 17 - 19 - 22 - 24 mm

10 \square 3/8

- suitable for wheel axles
- 4 different internal hexagon sizes: 17 - 19 - 22 - 24 mm
- suitable for Yamaha, Kawasaki, BMW, Suzuki, Honda



Item #
5058



Motorcycle Special Socket | 19 - 22 - 24 mm

- three different internal hexagon sizes:
 - 19 mm for Yamaha
 - 22 mm for Kawasaki, BMW
 - 24 mm for Suzuki, Honda, BMW K1, K1000
- for assembling / disassembling of the full floating axle
- 19 or 22 mm hexagon drive socket (socket not included)



Item #
5059



Clutch Cage Holder

- application: grasps into the clutch driver grooves and arrests it so that the central nut can be loosened securely
- bolt diameter: 5 and 9 mm



Item #
1713



Chain Cutter | for Chains 3/8" - 5/8"

- to separate motorcycle O-ring, X-ring and conventional chains



Item #
1743



Chain Cutter | for Chains 3/4" - 1 1/4"

- to separate motorcycle O-Ring, X-Ring and conventional chains



Item #
8634



Chain Adjusting Tool | for Ducati | Triumph

- for turning the eccentric hub and adjusting the chain tension
- material: Stainless steel



Item #	Description
5086	Chain Adjusting Tool for Ducati 748 916 996 998
5087	Chain Adjusting Tool for Ducati 1098 / 1198
5088	Chain Adjusting Tool for Triumph

Riveting Tool | for Motorcycle Chains

- for separating and riveting chains
- suitable for hollow rivet chain locks, for chain sizes 35 - 525
- 3 separating tips included: 2.2 - 2.9 - 3.8 mm



Item #
8802

Chain Cleaning Brush | for Motorcycle Chains | 250 mm

- U-shaped brush allows easy drain cleaning
- extends the life of the chain



Item #
8362



Motorcycle Chain Tool Set | 21 pcs.

- is required when replacing motorcycle chains

includes the following 3 chain service tools:

- chain lock clip pliers for removal and installation of chain lock clips
- chain holding tool, holds both ends of the chain together
- extensive chain link separating and riveting tool, for disassembly and assembly of drive and timing chains
- drift punch diameter: 2.2 - 2.9 - 3.8 - 4.8 mm

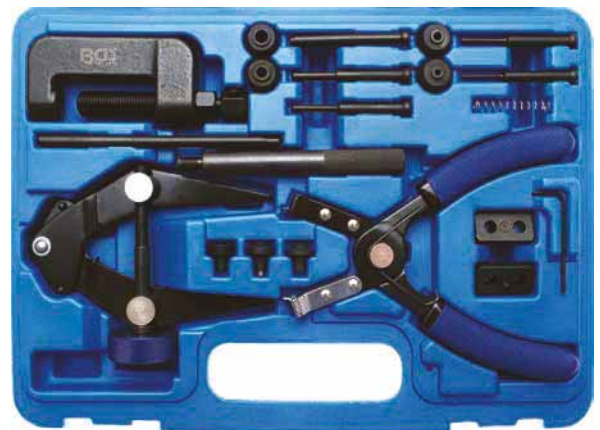

Item #
8867

Axle Nut Sockets | for Ducati | 8 pcs.

12.5  1/2

- for removal of the front and rear wheels
- aluminium alloy steel, anodized
- 12.5 mm (1/2") drive
- 2-in-1 combined socket
- axle nut socket, 12-point, 55 mm for rear axle nut
- axle nut socket, 12-point, 46 mm for front axle nut
- axle nut socket, 12-point, 28 mm for rear axle nut
- axle nut socket, hexagon, 41 mm for front axle nut
- axle nut socket, hexagon, 30 mm for front axle nut
- axle nut socket, hexagon, 28 mm for rear axle nut



Item #
5061

Special Socket | for axle Nuts | for Ducati

12.5  1/2

- for loosening / tightening axle nuts
- suitable for following Ducati models: 1098, 1198 Streetfighter or Multistrada, 1200, 748, 848, 916, 996, 998, Hypermotard, Multistrada, Monster, Supersport, Sport Classic
- 12-pt, 55 mm for rear wheel axle nuts
- 6-pt, 28 mm for front wheel axle nuts
- aluminium alloy steel, anodized



Item #
5071

Fork Cap Wrench | for Öhlins Forks

12.5  1/2

- suitable for most Öhlins models
- for disassembly and assembly of the upper fork tube caps
- rubber pad prevents damage to the nut
- 12.5 mm (1/2") and hexagon drive
- material: aluminium alloy
- surface finish: anodised



Item #
5062

Front Axle Alignment Tool | for Ducati | Ø 30 mm

- allows mounting and aligning of the front wheel axle when tightening the axle nut
- suitable for Ducati 848, 1098, 1198 and other models with 30 mm axle inner diameter
- material: aluminium alloy
- surface finish: anodised



Item #
5068

Front Axle Alignment Tool | for Ducati | Ø 25 mm

- allows mounting and aligning of the front wheel axle when tightening the axle nut
- suitable for Ducati 999, ST2, ST3, ST4, 620SS, 800SS, 1000SS and other models with 25 mm axle inner diameter
- material: aluminium alloy
- surface finish: anodised

Item #
5069



Groove Nut Socket for Suzuki swing arms

12.5  1/2

- suitable for swing arm pivot nuts on following Suzuki motorcycle models: SV 650 / 1000, DL 650 / 1000, GSX-R 750 / 1000 / 1100
- 12.5 mm (1/2") drive
- surface finish: satin chrome plated

Item #
5360



Spoke Torque Wrench | interchangeable Heads | 3 - 15 Nm

6.3  1/4

- rim life is extended by tightening all the spokes with the same torque value
- 10 interchangeable heads with 12 x 9 mm square drive, suitable for the most popular spoke sizes:
 - 5.1 - 5.8 - 6.1 - 6.3 - 6.4 - 6.5 - 6.7 - 6.9 mm
 - ratchet head: 6.3 mm (1/4"), 24-tooth, for sockets
- with quick release button
- torque range: 3 - 15 Nm
- length: 195 mm

Item #
8511



Spoke Wrench Set | for Motorcycles | 10 pcs.

- is required for injecting or re-tightening rim spokes
- sizes: 5.2 - 5.4 - 5.6 - 5.8 - 6.0 - 6.2 - 6.4 - 6.6 - 6.8 - 7.0 mm

Item #
8360

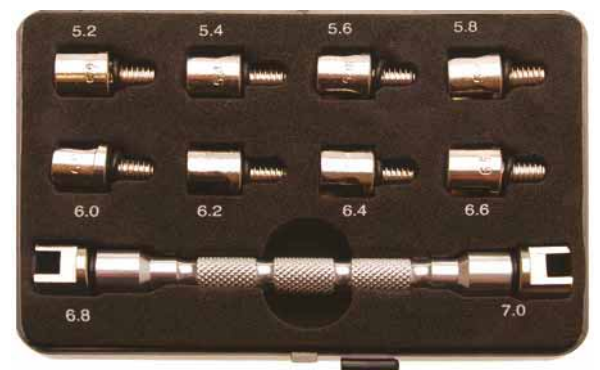

Wire Spoke Wrench

- forged
- with 4 cuts suitable for 6.3 - 5.6 - 5.0 - 4.5 mm nipples
- for tightening wire spokes on a bicycle
- surface finish: chrome-plated

Item #
7180



Brake Bleeding Bottle | for Motorcycles

- allows a bleeding of brake and clutch systems on motorcycles
- magnet for attachment to the frame
- includes 3 adaptors

Item #
8171

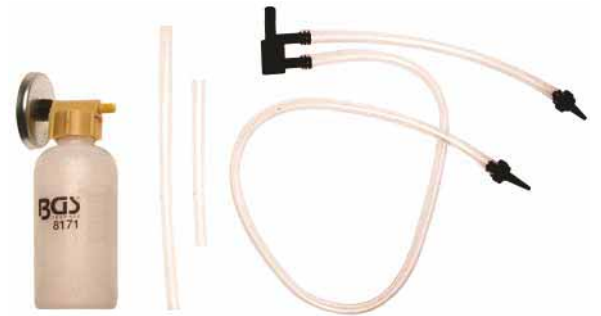

Brake Piston Removal Kit | for Motorcycles | 14 pcs.

- suitable for nearly all brands
- for piston diameter 19 to 30 mm
- allows easy disassembly of brake pistons
- especially suitable for deeply stuck brake pistons

Item #
8242



Brake Piston Pliers | for Motorcycles

- for removing the brake pistons
- suitable for scooters, quads and motorcycles
- knurled jaws for better grip
- suitable for piston inside diameter 17 - 40 mm

Item #
8419



Wheel Bearing Tool Set | for Harley-Davidson

- ideal tool for the assembly and disassembly of wheel bearings without damaging the wheel
- suitable for wheel bearings with 3/4" and 1" inner Ø, built 2000 - 2006 and for 25 mm wheel bearings installed on models from 2007 - 2008 with and without ABS



Item #
8373

Steering Head Bearing Assembly Tool Kit | for Motorcycles

- allows a careful assembly of upper and lower steering head bearings
- suitable for Kawasaki, Honda and Harley Davidson
- Includes:
 - 1 press nut with crank
 - 1 mounting screw
 - 1 nylon washer
 - 2 step rings for Kawasaki
 - 2 step rings for Honda
 - 1 step ring for Harley Davidson
 - 1 washer plate
 - 1 pressure washer
- material: carbon steel
- surface finish: satin chrome-plated

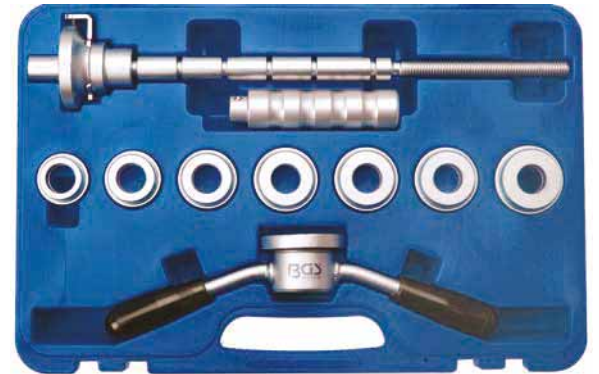

Item #
8461

Fork Seal Driver Set | for Motorcycles | 9 pcs.

- for use on conventional and upside-down forks
- allows quick and convenient replacement of fork seals without disassembling the conventional fork legs
- knurled ring for better grip
- half shells, 2 pcs. 35/36 - 39 - 41 - 43 - 45 - 46/47 - 48 - 49/50 - 54 mm
- surface finish: galvanised, yellow



Item #
8474

Fork Seal Driver | for Motorcycles

- for installing seals into motorcycle forks
- adjustable for fork diameter from 35 to 45 mm
- suitable for many motorcycle types



Item #
8895

Steering Head Bearing Remover | 26 - 35 mm

- allows dismantling of steering head bearings
- suitable for bikes with 26 to 35 mm bearing assemblies
- length: 305 mm



Item #	Description
8509	Steering Head Bearing Remover 26 - 35 mm
8510	Steering Head Bearing Remover 35 - 55 mm



Bowden Cable Oiler

- for easy and accurate maintenance of all cables
- good lubrication of bowden cables increases cable life



Item #	
8391	

Rotor Puller Set | for Motorcycles | 10 pcs.

- fits Yamaha, Honda, Suzuki, Bosch Kawasaki, Ducati and many others
- includes:
 - M14 x 1,5 (7748-A)
 - M16 x 1,5 (7748-B)
 - M18 x 1,5 (7748-C)
 - M19 x 1,0 (7748-G)
 - M22 x 1,0 - M25 x 1,5 (7748-E)
 - M22 x 1,5 - M26 x 1,5 (7747)
 - M26 x 1,0 - M28 x 1,0 (7748-D)
 - M27 x 1,25 - M20 x 1,0 (7748-I)
 - M27 x 1,0 - M24 x 1,0 (7748-K)
 - M28 x 1,5 (7748-F)



Item #
7748

Rotor Puller

- suitable for generator and ignition system
- M27x 1.00: Honda, Suzuki, Yamaha
- M26x 1.50: Bosch



Item #	Description
7746	Rotor Puller M27 x 1.0
7747	Rotor Puller M22 x 1.5 / M26 x 1.50



Rotor Puller | M22 x 1.5 | for Suzuki motorcycles

suitable for the following Suzuki models:

- GV 1400G (1986 - 1988), LS 650 (1987 - 2009)
- LTA 400 (2002 - 2004), LTA 400 (2006 - 2008)
- LTA 400F (2002 - 2008), LTA 450X (2007 - 2009)
- LTA 500F (2000 - 2007), LTA 700X (2005 - 2007)
- LTA 750X (2008 - 2009), LTF 400 (2002 - 2004)
- LTF 400 (2006 - 2008), LTF 400F (2002 - 2008)
- LTF 500F (1998 - 2007), VL 1500LC (1998 - 2004)
- VL 1500LC C90 (2005 - 2009)
- VS 1400GLP (1987 - 2004)
- VS 1400GLP (Daewoo 2005 - 2009)
- VS 700 GLP (1986 - 1987)
- VS 750 GLP (1988 - 1991), VS 800GL (1992 - 1995)
- Saab 800 as of 1990 - 1993, 1800 as of 2006 - 2007

- material: carbon steel
- surface finish: phosphated

Item #
8466



Rotor Puller | M27 x 1.0 | for Aprilia, Benelli, Beta, CPI, Italjet, KTM, MBK, Yamaha

- left hand thread M27 x 1.0
- M16 clamping spindle with sliding bar
- internal diameter 18 mm

suitable for e.g. the following bicycles:

- Aprilia Area, Gulliver, Scarabeo, Sonic, SR 50, etc.
- Benelli 491 50, K2 50, Naked 50, Pepe 50, etc.
- Beta Ark 50, Eikon 50, Quadra 50 , Tempo 50 etc.
- CPI Aragon 50, Crab 50, Formula 25, GTR 50, etc.
- Italjet Dragster 50KTM Ark 50, Kross 50MBK CS 50, CW 50, EW 50, YH 50, YN 100, etc.
- Yamaha CA 50, CS 50, CW 50, EW 50, YE 50, etc.

- length: 97 mm
- material: steel (S45C)

Item #
8726



Rotor Puller

- for pulling flywheels
- suitable for 5 different internal threads M14 x 1.5 - M16 x 1.5 - M18 x 1.5 - M24 x 1 - M27 x 1
- M24 x 1 - M27 x 1 with 21 mm cut-out for counterholding
- length: 165 mm
- width: 165 mm



Item #
8613

Holding Wrench | for Flywheels and Clutch Baskets

- simplifies removal of flywheels, clutch baskets etc.
- fits most scooters and other 2-stroke engines
- suitable for diameters from 93 to 130 mm



Item #
8457



Clutch Basket Holding Pliers | 300 mm

- for loosening clutch baskets, chain sprockets, etc.
- holding pins (Ø 8 mm x 10 mm length) and 37 mm retaining legs
- max. opening: 125 mm
- locking pliers mechanism
- length: 300 mm



Item #
8944



Flywheel Puller | for KTM, Suzuki, Yamaha

- allows a non-destructive removal of flywheels with an M33 x 1.5 external thread
- size 17 mm

suitable for the following motorcycles:

- KTM: 625 SMC (2006), 640 LC4 ADVENTURE (2004-2007), 640 LC4E (2001), 690 RFR (2008)
- SUZUKI: GSXR 1000 (2001-2008), GSXR 600 (2001-2009), GSX R750 (2000-2008)
- YAMAHA: WR 450F (2004-2008), YFZ 450 (2004-2009)



Item #
8465

Flywheel Puller | for Yamaha, Kawasaki (Jet Ski)

- suitable for Yamaha WR 250F/WR400F and Kawasaki Jet Ski 300/440/550
- facilitates damage-free removal of the fly wheel
- 3x 8 mm screws on a 55 mm round base are connected to the flywheel
- 14 mm pressure spindle with sliding T-handle
- incl. 3 screws M8 x 40 mm

Item #
8248



Valve Spring Compressor Set | 16 - 30 mm

- for smaller engines and motorcycles
- 5 interchangeable bearing drivers
- 100 mm C-Clamp
- includes the following tools:
 - pressure screws 70 mm, 101 and 120 mm length
 - pressure pieces Ø 16 mm, 19 mm, 23 mm, 25 mm, 30 mm
 - telescopic magnetic pick-up tool
 - tweezers

Item #
1768



Alternator Cover Puller | for Ducati

- for removal of the left-hand engine cover
- suitable for Ducati models manufactured in the time period between 1990 and 2009: 600 / 620 / 695 / 696 / 748 / 749 / 750 / 800 / 848 / 851 / 888 / 900 / 906 / 907 / 916 / 996 / 998 / 999 / 1000 / 1078 / 1098 / 1100 / 1198
- material: body made of aluminium alloy steel, anodised, studs and spindle made of carbon steel

Item #
5063



Clutch Basket Holding Tool | for Ducati

- suitable for all current 6-speed Ducati models with dry clutch
- allows a damage free disassembly/assembly of clutch components
- includes retaining bolt for locking the tool
- material: GRP polyamide



Item #
5064



Camshaft Locking Tool | for Ducati 851, 888, 916, 996

- for locking camshaft when replacing the timing belt, checking the engine timing, etc.
- suitable for Ducati models 851, 888, 916 and 996
- material: aluminium alloy
- surface finish: anodised



Item #
5065

Camshaft Locking Tool | for Ducati 4-Valve engines

- for locking camshaft when replacing the timing belt, checking the engine timing
- suitable for Ducati models 748, 916, 996 and Desmoquattro
- not suitable for ST4 or S4 engines
- material: aluminium alloy
- surface finish: anodised



Item #
5066

Camshaft Locking Tool | for Ducati (Testastretta)

- for locking camshaft when replacing the timing belt, checking the engine timing, etc.
- suitable for 4-valve Ducati models 749, 999 with Testastretta engines
- material: aluminium alloy
- surface finish: anodised



Item #
5067

Camshaft Locking Tool | for Ducati | 2 pcs.

- is needed when loosening the central screw of the camshaft wheel
- suitable for Ducati Diavel (Carbon), Monster, Multistrada, Streetfighter and Superbike
- includes two locking tools



Item #
5076



Oil Filter Wrench | 14-point | Ø 74 mm | for BMW Motorcycles

12.5  1/2

- 12.5 mm (1/2") drive
- profile: external 14-point
- diameter: 74 mm



Item #
1043



Oil Filter Wrench | 12-point | Ø 76 mm | for BMW motorcycles

12.5  1/2

- suitable for all BMW motorbikes with Ø 76 mm oil filters, except K1200S / RS
- 24 mm and 12.5 mm (1/2") drive
- aluminium



Item #
5073



Oil Filter Wrench | 14-point | Ø 76 mm | for BMW motorcycles, Ducati, Harley-Davidson

12.5  1/2

- for oil filter Ø 76 mm x 14-pt.
- 24 mm and 12.5 mm (1/2") drive
- aluminium

suitable for the following motorbikes:

- BMW before 2009
- Harley-Davidson
- Ducati



Item #
5074



Oil Filter Wrench | 6-point | Ø 76 mm

12.5  1/2

- suitable for 76 mm oil filters with 6 grooves, installed in:
 - Audi A3, A4, A6
 - BMW motorcycles
 - Citroën C5, Xantia
 - Fiat Brava, Bravo, Punto, Tipo
 - Ford Fiesta, Escort
 - Mercedes Benz cars, Sprinter
 - Peugeot 106, 206, 306, 406
 - Renault Clio, Kangoo, Megane, Laguna, Rapid
 - Honda Accord, Civic, Prelude, CRX
 - Opel Astra G/F, Corsa S/B, Calibra, Zafira, Frontera
 - Suzuki Grand Vitara 1.9 2009
 - VW Golf III and IV, Polo, Passat, Sharan
 - Seat Alhambra, Toledo, Leon, Cordoba
 - Škoda Octavia
- also suitable for fuel filters on Renault Espace, Laguna, R19 and Volvo S40, V40 up to 99
- black coated steel
- profile: groove profile
- diameter: 76 mm



Item #
8539



Flywheel Locking Tool | for Ducati

- for holding the flywheel during loosening / tightening of the flywheel nut
- suitable for the following Ducati models:
 - Monster 400 2002-2008 / Monster 620 2002-2006
 - Multistrada 620 2006 / Sport 620 2003
 - Monster 659 2012-2013 / Monster 695 2007-2008
 - Monster 696 2007-2012 / 748 S/R 2002
 - 749 S/R 2003-2006 / Monster 750 2002
 - Sport 750 2002 / SuperSport 750 2002
 - Monster 795 2012-2013 / Monster 796 2011-2013
 - Hypermotard 796 2010-2012 / Monster 800 2003-2004
 - Sport 800 2003 / SuperSport 800 2003-2007
 - 848 2009-2012 / MH Evoluzione 2002
 - Monster 900 2002 / Sport 900 2002
 - SuperSport 900 2002 / Monster S4 916 2002
 - ST4 916 2001-2005 / ST2 944 2002-2003
 - ST4S 996 2003-2005 / 996R 2001
 - Monster S4R 2004-2006 / 998 / S 2002-2004
 - 999 R/S 2002-2007 / GT1000 2007-2010
 - Monster S/S2R 1000 2003-2008
 - Multistrada DS/S 1000 2003-2006
 - Paul Smart 1000 2006 / Sport 1000 2006-2009
 - ST3 1000 2005-2007 / SuperSport 1000 2003-2006
 - Hypermotard 1100 EVO/S 2008-2010
 - Monster 1100 2009-2010 / Multistrada 1100 2007-2010
- outside diameter: 175 mm
- inner diameter: 150 mm
- length: 680 mm



Item #
5077

Alternator Drive Flange Holder | for BMW Motorcycles K-Series

- for holding the alternator drive flange & the crankshaft split gear
- suitable for BMW K models
- to be used as OEM 124600



Item #
5078



Groove Nut Wrench | for BMW Cylinder Head

- for lock nut on cylinder head to main frame
- suitable for BMW F series motorcycles



Item #
5079



Valve Stem Seal Mounting Tool | for BMW Motorcycles R-Series

- for mounting the valve shaft seals on BMW R series motorcycles



Item #
5082



Camshaft Pulley Extractor | for Ducati

- for removing the camshaft wheel
- suitable for following Ducati models: Hypermotard, Monster, Multistrada, Sportclassic, Sporttouring, Streetfighter, Superbike, Supersport MH900E, Diavel (Carbon)



Item #
5083



Special Socket | for Ducati Pully Nut Socket | 28 mm

- allows removing and re-torquing of the camshaft wheel nut
- suitable for Ducati 749, 999, 1098 848 and 1198
- external hexagon 19
- wrench size: 19 mm



Item #
5084



Special Socket | for Ducati Pully Nut Socket | 24 mm

- allows removing and re-torquing of the camshaft wheel nut
- suitable for Ducati 748 and 916
- external hexagon 19
- wrench size: 19 mm



Item #	
5085	

Clutch Disc Centering Tool | for BMW Motorcycles | 2-Valve engines

- to align the clutch disc while tightening the pressure plate
- suitable for all 2-valve air-cooled engines from 1981 to 1996



Item #	Description
5089	Clutch Disc Centering Tool for BMW Motorcycles 2-Valve engines
5090	Clutch Disc Centering Tool for BMW Motorcycles R and K Series
5091	Clutch Disc Centering Tool for BMW Motorcycles R and K 1200

TDC Dial Indicator for Ignition Adjusting | for Motorcycles

- precision gauge for locating the piston TDC
- allows precise ignition timing
- suitable for most cylinder heads
- spark plug thread adaptor in 10, 12 and 14 mm
- includes:
 - 1 gauge 10 mm stroke, 1/100mm graduation
 - 1 adaptor with gauge clamp, length 3 cm
 - 1 extension M8 x 1.0, length 3 cm
 - 1 adaptor M10 x 1.0
 - 1 adaptor M14 x 1.25
 - 2 stylus extensions

Item #	Description
8319	TDC Dial Indicator for Ignition Adjusting for Motorcycles
8319-1	Gauge for BGSs 1938 / 8319 / 8159 Ø 42 mm



Piston Height Adjustment Tool | M14 x 1.25

- required when setting the ignition timing on most older motorcycles with 2-stroke engines
- knurled sleeve for accurately positioning the piston height
- suitable for engines with M14 x 1.25 spark plug thread

Item #	
9273	



3-in-1 Clutch / Variator Tool for Piaggio

- for blocking and removing the variator and clutch bell
- integrated hex wrench for loosening the coupling nut, 34 mm, pin pitch: 55 mm
- made of corrosion-resistant stainless steel
- to be used as OEM 14569-PI
- suitable for many models of following manufacturers: Aprilia, Derbi, Gilera, Italjet, Peugeot, Piaggio, Vespa



Item #
8729



Spark Plug Puller (without Sliding Handle) | internal Hexagon 22 mm | for BMW Motorcycles

- for pulling the spark plugs plug and loosening the 22 mm internal hexagon front axle
- note: additional sliding bar required, not suitable for water-cooled R 1200 GS
- sliding bar bore: 19 mm
- material: aluminium



Item #
8939

Synchronous Carburetor Tester | with 4 synchronous clocks | 29 pcs.

- for synchronous measurement on 2 - 4 carburetors with vacuum connection on the carburetor
- after adjusting and checking the valve leeway, the carburetors should be synchronised
- all-purpose
- perfect measurement results with mechanically faultless engines
- to be used while the engine is running
- suitable for cars and motorcycles
- 4 pressure gauges Ø 92.5 mm fitted on a plate
- 4 rubber hoses 7.2 x 5 x 750 mm
- 4 hose clamps with spare sealing rings
- 4 connectors 53 mm (M6 x 0.75)
- 4 connectors 60 mm (M6 x 1.00)
- 4 extensions 3.9 x 98 mm
- 4 extensions 3.9 x 170 mm
- 1 adapter
- negative pressure measuring range: 0 TO -70 cm Hg (0 to -30 In Hg)
- pressure measuring range: 0 to 14 PSI (0 to 1 kg/cm²)



Item #
62670

Motorcycle Battery Disconnect Adaptor

- for disconnecting the battery when not used for a prolonged period - can also be used to prevent theft
- electrical isolation of the battery negative pole
- suitable for batteries with flat M6 terminals
- dimensions (L x W x H): 64 x 21 x 19 mm



Item #
9310



Hydraulic Lifter | for Motorcycles and ATV | 680 kg

- suitable for motorcycles with underslung frame & ATV
- rubberized lifting frame
- length: 865 mm
- frame length: 325 mm
- width: 360 mm
- frame width: 335 mm
- max. lifting height: 420 mm
- min. lifting height: 145 mm
- stroke: 275 mm
- height: 325 mm
- rated load capacity: 680 kg



Item #	Description
8389	Hydraulic Lifter for Motorcycles and ATV 680 kg
8389-1	Replacement Hydraulic Cylinder for BGS 8389

Motorcycle Lifter for Single-Sided Swingarms on Rear Axles

- suitable for single-sided swingarms on rear axles
- ball bearing holding bolt for rear axles
- very useful when the wheel must be turned e.g. when cleaning the rims, lubricating the chain, etc.
- allows removal of the rear wheel on motorcycles without center stand
- 24.8 mm lifting pin
- adjustable lifting height in the following 6 steps: 1. step 350 mm - 2. step 375 mm - 3. step 400 mm - 4. step 425 mm - 5. step 450 mm - 6. step 475 mm
- with plastic-covered wheel lock pole
- capacity: 200 kg



Item #
9244

Motorcycle Wheel Balancer

- an economic alternative to an expensive balancing machine
- allows static balancing of motorcycle tires up to 740 mm diameter and 320 mm width
- centering cone: Ø 17 to 29 mm wheel centering
- painted steel frame with a carbon steel made balancing shaft
- includes 2 centering cones for centering the wheel on the balancing shaft
- precision ball bearings provide a low-friction pendulum motion for precise balancing of the wheel



Item #
8459

Central Lift | for Dirt Bikes / Cross Motorcycles

- facilitates cleaning of the wheels and is helpful for maintenance and repairs of the chain drive and the wheel suspension
- min. height: 270 mm
- max. height: 390 mm
- lifting plate surface: 230 x 285 mm
- max. load capacity 135 kg



Item #
8424

Brake Calliper Tool for Iveco Trucks | 7 pcs.

- for resetting the brake pistons on Iveco disk brakes
- suitable for Iveco Stralis, Eurocargo, Daily
- 10 mm ratchet wrench
- rewind tool
- backing plate
- 2 reset discs with 3 pins
- 2 micro bits internal hexagon 8 mm with 10 mm drive



Item #
1104

Socket for Brake Calliper | E-Type (for Torx) | for MAN TGL | 30 mm Drive

- with spring ball
- length: approx. 40 mm
- 30 mm 6-pt. drive
- **E20 - BGS 6451**
suitable for MAN TGL brake calipers
- **E24 - BGS 6452**
suitable for MAN TGA brake calipers



Item #	Description
6451	Socket for Brake Calliper E-Type (for Torx) for MAN, TGL 30 mm Drive E20
6452	Socket for Brake Calliper E-Type (for Torx) for MAN, TGL 30 mm Drive E24

Tyre Lever | for Trucks | special Type | 650 mm

- ideal for commercial vehicles, agricultural and construction machines
- heavy duty version
- for pulling tyres off the rim
- extra rounded lever end for material-preserving use
- dimensions: 650 x 28 x 9 mm



Item #
4802



Truck Tyre Assembly / Disassembly Lever | 28 - 30 mm | 2 pcs.

- for removing and installing truck tyres
- allows renewing of tires without mounting device and power supply
- suitable for 22.5 and 24.5" truck tyres
- length: 1310 mm



Item #
8891

Truck Tyre Assembly / Disassembly Lever

- allows fast and easy truck tire demounting
- suitable for demounting 20", 22.5" and 24.5" tube and tubeless type truck tires, up to a 13" (330 mm) wide wheel
- ergonomic shaped steel handle with no-slip grip, for optimum leverage while reducing back strain
- suitable for demounting of the tire without lifting the entire wheel
- aluminium bead support for grabbing the top bead of Super Single and Super Wide tires
- 2 heavy-duty nylon castors



Item #
9095

Four-Way Wheel Wrench for Trucks | 24 x 27 - 32 x 20 mm (3/4")

- length 60 cm
- higher torque through adjustable joint



Item #
1458

Four-Way Wheel Wrench for Trucks | square | 24 x 27 x 32 x 20 mm (3/4")

- with square plate
- armlength 70 cm
- max. torque: 24 mm (450 Nm) - 27 mm (590 Nm) - 32 mm (880 Nm) - 20 mm (3/4") (890 Nm)
- surface finish: chrome plated
- surface finish, heads: polished



Item #
1457

Nut and Cap Key Set | 13 pcs.

- continuously adjustable from 49 to 145 mm
- suitable for hexagon and 8-pt nuts, groove nuts and round nuts
- 3 different pin sizes: 6 mm, 8 mm und 10 mm
- side length 45 mm
- can be used for all special sizes
- 20 mm (3/4") and 12.5 mm (1/2") drive
- surface finish: chrome plated



Item #
1513

Truck Socket | 8-point | Ø 80 - 115 mm | for utility vehicles

- suitable for axle nuts on rear axles and front axles
- sockets with Ø 80, 100, 111 and 115 mm
- material: chrome vanadium steel (S2)
- surface finish: black

Item #	Description
5413	Truck Socket 8-point Ø 80 mm for SCANIA front wheel
5417	Truck Socket 8-point Ø 100 mm SCANIA
5410	Truck Socket 8-point Ø 111 mm BPW 12 t
5416	Truck Socket 8-point Ø 115 mm Volvo



Pin Wrench for Gearbox Flange | for Scania | 72/80 mm

20 3/4

- suitable for SCANIA
- for dismantling of the main drive shaft flange
- socket with 3/4" drive
- made from heavy duty steel



Item #
5421

Groove Nut Socket | inside pins | for Ford Transit with axle Type 34

12.5  1/2

- suitable for Ford Transit 80 / 100 / 115 / 120 with Type 34 wheel axles
- 12.5 mm (1/2") drive
- internal diameter: 60 mm
- internal height: 25 mm

Item #
5423



Groove Nut Socket | outside pins | for Mercedes-Benz Rear Axles

20  3/4

- in accordance with DIN 3121 / ISO 1174
- suitable for high tightening and loosening torque
- number of pins: 6
- pin width: 10 mm
- weight: 2.6 kg

BGS 8268

- suitable for Mercedes Benz Actros rear axle
- HL/HL 8 (Hypoid) ect.
- internal diameter: 105 mm
- outside diameter: 125 mm
- height: 182 mm
- pin diameter: 115 mm

BGS 8269

- suitable for Mercedes-Benz Benz Atego rear axle, Vitaro 814, MAN, etc.
- internal diameter: 80 mm
- outside diameter: 95 mm
- stud diameter: 49 mm
- height: 185 mm
- pin diameter: 87 mm



Item #	Description
8269	Groove Nut Socket for Mercedes-Benz Atego 80 - 95 mm
8268	Groove Nut Socket for Mercedes-Benz Actros 105 - 125 mm



Rear Axle Nut Spanner | for Mercedes-Benz Van W901 / W905

- for loosening and tightening the wheel bearing lock nut on rear axle shafts (plug shafts)
- suitable for Mercedes Sprinter models W901 / W905, rear axle type 741.407 / 741.408 / 741.409 with groove nut 902 357 01 26

Item #
9207



Ball Joint Separator | extra large | for utility vehicles

- for trucks
- forged type
- universally applicable

Item #
1802



Wheel Hub Puller | for BPW 12 t | M136 x 2.5

- puller bell and spindle made of high-strength steel

Item #
5404



Cooling System Diagnostics Tool Set | 9 pcs.

- cooling system testing
- 0 - 2.5 bar pressure gauge (tolerance +/- 2 %)
- aluminium housing, anodised
- with quick-action coupling
- with pump and cooler adaptors for:
 - DAF XF 95, XF 105
 - Scania 113, 114, 124 and 125
 - Volvo FH 12
 - Iveco Daily 2000 C-series, EURO-Star, EURO-Tech, Euro-Truck, Strahlis
 - Renault Magnum
 - MAN L 2000, TGA, F90, F2000
 - Mercedes-Benz Actros, Atego, Axor, ECO 8401, 1728, Sprinter manufactured before 2006, Vito

Item #	Description
8514	Cooling System Diagnostics Tool Set 9 pcs.
8514-1	Adaptor Hose for BGS 8514
8514-2	Pressure Pump with Gauge for BGS 8514
8514-3	Cooler Adaptor for BGS 8514 for Scania
8514-4	Cooler Adaptor for BGS 8514 for DAF-XF 95, XF 105
8514-5	Cooler Adaptor for BGS 8514 for Mercedes-Benz / MAN / Iveco
8514-6	Cooler Adaptor for BGS 8514 for Iveco Daily
8514-7	Cooler Adaptor for BGS 8514 for MAN L 2000, TGF
8514-8	Cooler Adaptor for BGS 8514 for Volvo FH
8514-9	Cooler Adaptor for BGS 8514 for Mercedes-Benz van



Turbocharger System Test Set | for Trucks | 7 pcs.

- for checking the charging system components when installed
- suitable for turbochargers and compressor systems
- incl. pressure regulator with gauge for reducing the test pressure and for leakage test
- 3 pairs of test adaptor (test and closure cap) for hose Ø 105 - 110, 115 - 120, 125 - 130 mm



Item #
8959

Groove Nut Socket | outside pins | for Trucks | 4 pcs.

12.5 \square 1/2

- sockets for working on the nozzle holder
- socket with 12.5 mm (1/2") drive, 4-tooth, length 72 mm, fits Mercedes series OM 401/421, 403/423, LA, A, 470
- socket with 32 mm outer hexagon, length 70 mm 4-tooth with internal thread M14 1.5 mm fits Mercedes, Neoplan, Setra
- socket with 12.5 mm 1/2" drive, 3-tooth, length 120 mm, fits Mercedes, MAN
- socket with 32 mm outer hexagon, length 120 mm 4-tooth, fits MAN, Mercedes



Item #
67210

Injection Nozzle Extractor | for MAN, Mercedes-Benz | four teeth

- extractor made of carbon steel with four tooth and 27 mm hexagon for counterholding
- suitable for MAN and Mercedes trucks
- puller spindle M 14
- spindle with 6 mm hex drive for mounting the nozzle on the spindle
- allows easy and professional removal of the nozzle
- length: 105 mm



Item #
67230

Special Socket for Nozzle Block | 32 mm Drive | for Mercedes-Benz, Neoplan, Setra

- for the screw on the nozzle holder
- 4-tooth with internal thread M14 x 1.5 mm
- 32 mm outer hexagon drive, length 70 mm
- also as spare part for BGS 67210



Item #
67210-1

Crankshaft Locking Tool | for Ford Transit 2.2

- suitable for Ford Transit 2.2 manufactured before 2006
- for locking crankshaft and flywheel
- allows the TDC sensor position to be set after working on cam chain drive system
- crankshaft locking tool to be used as OEM 303-1587
- flywheel locking tool to be used as OEM 21-251 / 303-698
- timing pump locking pin to be used as OEM 0188H / 1860965000



Item #

8896

Cylinder liner Puller with counter support | 60 - 160 mm | 6 pcs.

- for dismantling wet cylinder liners with a diameter of 60 to 160 mm
- suitable for commercial vehicles (Mercedes Benz, MAN) passenger cars, stationary engines etc.
- new type spreading system provides problem-free and firm hold at the lower edge of the bush



Item #

9465

Oil Filter Wrench Set | for utility vehicles | 9 pcs.

10  3/8

- oilfilter cap wrench 36 mm x 6-pt: for Mercedes-Benz Axor BR400, Atego BR900, Actros BR 500 Scania PDE V8 engines, HPI engines with oil filter
- oilfilter cap wrench 74 mm x 14-pt., for Mercedes-Benz Sprinter 600 VW Transporter
- oilfilter cap wrench 106 mm x 15-pt., for Man 8 10 To, Series L2000 Scania PDE V8-engine, Fiat Ducato, Iveco 2.5 D/TD
- oilfilter cap wrench 107 mm x 15-pt., for Volvo, Iveco, Renault, Scania
- oilfilter cap wrench 108 mm x 15-pt., for Volvo, Iveco, Renault, Scania
- oilfilter cap wrench 108 mm x 18-pt., for Renault Transporter, Master, Traffic, Opel Movano with 2.4, 2.5, 2.8D / 2,8TD engines
- oilfilter cap wrench 135 mm x 18-pt., for Man 1848 To. Serie F2000, TGA
- 21 mm external hexagon and 10 mm (3/8") internal square drive
- 21 mm ring wrench
- universal oil filter wrench up to 160 mm
- surface finish: black lacquered



Item #	Description
1019	Oil Filter Wrench Set for utility vehicles 9 pcs.
1019-1	Oil Filter Strap Wrench Ø max. 160 mm
1019-2	Ring Wrench 12-point Ø 21 mm
1019-36	Oil Filter Wrench 6-point Ø 36 mm for utility vehicles
1019-74	Oil Filter Wrench 14-point Ø 74 mm for Mercedes-Benz, VW
1019-106	Oil Filter Wrench 15-point Ø 106 mm for Fiat, Iveco, MAN, Scania
1019-107	Oil Filter Wrench 15-point Ø 107 mm for Iveco, Renault, Scania, Volvo
1019-108	Oil Filter Wrench 15-point Ø 108 mm for Iveco, Renault, Scania, Volvo
1019-108-18	Oil Filter Wrench 18-point Ø 108 mm for Opel, Renault
1019-135	Oil Filter Wrench 18-point Ø 135 mm for MAN, TGA

Oil Filter Strap Wrench XL | Ø 125 - 145 mm

12.5  1/2

- for especially large oil filter diameters of up to 145 mm
- high-strength steel strip for long service life
- also suitable for loosening granulate air dryer cartridges on trucks



Item #
8793



Hydraulic Flaring Tool

- includes various sizes of dies and adaptors for working on flaring tubes of fuel lines, brake lines, transmission lines and air condition lines
- hydraulic pump for easy use

suitable for:

- metric bubble flaring 4.75 mm, 6 mm, 8 mm, 10 mm, according to SAE and DIN
- 45 degree double flaring 3/16", 1/4", 5/16", 3/8", 1/2", according to SAE and DIN
- GM fuel line forming 5/16", 3/8"
- push-connect flaring 1/4", 5/16", 3/8"



Item #	Description
8704	Hydraulic Flaring Tool
8704-1	Spare Hydraulic Pump for Item 8704

Hydraulic Flaring Tool

- includes various sizes of dies and adaptors for working on flaring tubes of brake lines, transmission lines and air condition lines
- hydraulic pump for easy use

suitable for:

- metric bubble flaring 4.75 mm, 5 mm, 6 mm, ISO, according to SAE and DIN
- 45 degree double flaring 1/4", according to SAE and DIN
- push-connect flaring 1/4"



Item #
9445

Hydraulic Flaring Tool

- 4,75 mm (3/16"), 5,00 mm, 6,00 mm
- light weight, used directly on the vehicle
- suitable for steel, aluminium, brass and copper lines
- suitable for coated wires
- for double and convex flares according to SAE and DIN
- includes pipe cutter with deburring tool

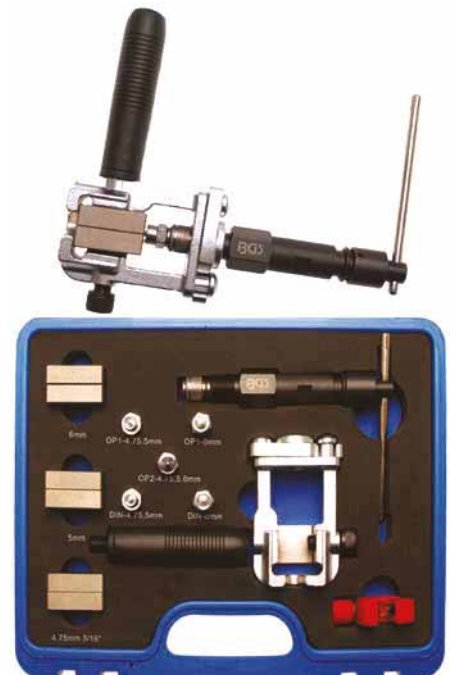

Item #	Description
8310	Hydraulic Flaring Tool
8310-1	Hydraulic Spindle for BGS 8310
8310-2	Punch Step1 for Item 8310 4.75 & 5 mm
8310-3	Punch Step1 for Item 8310 6 mm
8310-4	Punch Step2 for Item 8310 4.75 / 5 / 6 mm
8310-5	Punch DIN for Item 8310 4.75 & 5 mm
8310-6	Punch DIN for Item 8310 6 mm

Brake

Flaring Tool

- for flaring of brake and hydraulic pipes according to SEA and DI
- can be used on copper, brass, aluminium and steel pipes
- for coated and non-coated pipes
- for inside and outside flaring
- incl. 4 pairs of pressure pieces 3/16" / 4.75 mm - 1/4" - 6 mm - 8 mm
- 5 mm die blocks and punches also available

Item #	Description
3057	Flaring Tool
3057-13	Pre-Press Mandrel Step0 for BGS 3057
3057-14	Die Blocks for BGS 3057 Ø 4.75 mm (3/16")
3057-15	Die Blocks for BGS 3057 Ø 6.3 mm (1/4")
3057-16	Die Blocks for BGS 3057 Ø 5 mm
3057-17	Die Block for BGS 3057 Ø 6 mm
3057-18	Die Block for BGS 3057 Ø 8 mm
3057-19	Punch Step1 for BGS 3057 Ø 4.75 mm (3/16")
3057-20	Punch Step1 for BGS 3057 Ø 6.3 mm (1/4")
3057-21	Punch Step2 for BGS 3057 Ø 4.75 mm, 6.3 mm (3/16", 1/4")
3057-22	Punch Step1 for BGS 3057 Ø 5 mm
3057-23	Punch Step1 for BGS 3057 Ø 6 mm
3057-24	Punch Step2 for BGS 3057 Ø 5 mm, 6 mm
3057-25	Punch Step1 for BGS 3057 Ø 8 mm
3057-26	Punch Step2 for BGS 3057 Ø 8 mm



Flaring Tool | DIN | 4.75 mm (3/16")

- for flaring of 4.75 mm (3/16") brake pipes
- easy to operate
- can be used on mounted brake lines
- 2 component handle
- required spanner sizes: 10 and 17 mm
- incl. flaring grease

Item #	
8917	



Flaring Tool | SEA and DIN 4.75 mm (3/16")

- for easy and fast flaring of 4.75 mm (3/16") brake pipes, according to SAE and DIN
- allows single or double flares (only SAE)
- can also be used on installed brake lines
- required spanner sizes: 10 & 17 mm
- 2-component handle
- incl. flaring grease

Item #	
8918	



Double Flaring Tool Kit | 9 pcs.

- special tool for creating single D-type flares, double E-type flares (SAE) and double F-type flares
- suitable for pipes with wall thickness up to 1 mm
- 1 pipe clamp
- 1 spreader
- 7 dies 4.75 - 5 - 6 - 8 - 10 mm, 1/4" and 1/2"



Item #	Description
8615	Double Flaring Tool Kit 9 pcs.
3161	Die for Flaring Tool 1/2"
3160	Die for Flaring Tool 1/4"
3166	Die for Flaring Tool 10 mm
3164	Die for Flaring Tool 6 mm
3162	Die for Flaring Tool 4.75 mm
3163	Die for Flaring Tool 5 mm
3165	Die for Flaring Tool 8 mm

Universal Flaring Tool Kit | adjustable 4,7 - 16 mm

- quickly adjustable for creating conical / tapered flares
- for copper and aluminium pipes, sizes: 4.7 - 16 mm (3/16" - 5/8")



Item #
360

Tube Bending Tool | for pipe diameter 3 - 4.75 - 6 mm

- made from aluminium
- suitable for 3 - 4.75 - 6 mm tubes
- for aluminium, brass and copper pipes
- maximum bending radius approx. 15 mm



Item #
8228



Tube Bending Tool | for pipe diameter 6 - 8 - 10 mm

- suitable for 6 - 8 - 10 mm tubes
- for radius up to 180°
- for aluminium, brass and copper pipes
- maximum bending radius approx. 25 mm



Item #
3062



Tube Bending Pliers | 4.75 + 6 mm

- suitable for 4.75 and 6 mm tubes

Item #
8229



Tube Bending Tool | for copper pipes | 4 - 10 mm

- for bending 4 - 6 - 8 - 10 mm copper and aluminium pipes
- with two replaceable bending wheels, each providing 180° for 4/6 and 8/10 mm
- maximum bending radius approx. 18 mm

Item #
3061



Tube Bending Pliers | "4-in-1"

- 1 bending half-roll Ø 35 mm for 4.8 mm pipes (3/16")
- 1 bending half-roll Ø 28 mm for 6.4 mm pipes (1/4")
- 1 bending half-roll Ø 28 mm for 8.0 mm pipes (5/16")
- 1 bending half-roll Ø 25 mm for 9.5 mm pipes (3/8")
- allows bending of pipes up to 180°
- suitable for aluminium, copper and steel pipes
- rolls made of aluminium, basic unit made of steel, dipped coated grip

Item #
8718



Air Brake Bleeding and Oil Extraction Unit - pneumatic and manual

- allows a clean oil change by suction
- usable for engine, transmission, rear axle oil and other non-corrosive liquids
- suction hose 9.8 - 8.0 - 6.7 - 4.5 mm Ø for extraction by suction through the dipstick tube
- 10 l container with base ensures stability to accommodate large amounts of oil
- suitable for oil extraction on all Smart cars but also for all other vehicles for which an oil change is to be performed without using a car lift
- with a special silicone brake breather hose with a valve for one-hand operation
- easy brake bleeding on brake systems of all types of vehicles
- the built-in hand vacuum pump allows brake bleeding even without compressed air

Item #
3155



Air Brake Bleeding and Oil Extraction Unit

- allows a clean oil change by suction
- usable for engine, transmission, rear axle oil and other non-corrosive liquids
- 5 l fluid container
- suitable for oil extraction on e.g. all Smart models but also for all other vehicles for which an oil change is to be performed without using a car lift
- with a special brake breather hose and 2 extraction hoses
- easy brake bleeding on brake systems of all types of vehicles
- compressed air connection: 6.3 mm (1/4")
- working air pressure: 4.9 - 11.9 bar



Item #
3157

Air Brake Bleeder | 2 pcs.

- for quick and easy brake bleeding, can be used by one person only
- large 1.5 l canister with aluminium nozzle and clamp for compressed air (lets you keep both hands free)
- protects the main brake cylinder as no pumping required
- can also be used for hydraulic clutches
- 1000 mm silicone hose
- accurately fitting rubber adaptor for the bleeding nipple
- 1 l canister with shut-off valve and universal clamp for refilling the brake system



Item #	Description
8080	Air Brake Bleeder 2 pcs.
8080-31	Hose with Bleeding Adaptor for BGS 8080
8080-31-1	Adaptor for Brake Bleeder for BGS 8080-31
8080-32	Hose with Plastic Tube for BGS 8080
8080-32-1	Plastic Pipe for Hose 8080-32 from BGS 8080

Air Brake Bleeder

- air-assisted bleeding of brake and clutch systems
- brake fluid and compressed air is separated by a diaphragm
- pressure regulator and gauge for adjustment of working pressure (0 to 3 Bar)
- filling hose has a quick coupling for easy adaptor installation
- connection hose also comes with a quick coupling, 3.7 m length
- with safety valve
- dimensions: Ø 280 mm, height 460 mm
- 5 liters brake fluid reservoir
- comes with one adaptor E20 for the most common brake systems



Item #	Description
8315	Air Brake Bleeder
8315-3	Replacement Rubber Diaphragm for BGS 8315

Adaptor Set for BGS 8315 | for Audi, BMW, Ford, Honda, Nissan, Opel, VW

- with fast fastener coupling 6.3 mm (1/4")
- incl. adaptor for European (compressed air) coupling 6.3 mm (1/4")
- adaptor for Opel Ø 43.5 mm
- Opel closing lid Ø 43.5 mm, to close the second opening
- universal adaptor Ø 45 mm
- universal adaptor, pressure piece, 2 screw hooks with collars and chain
- Euro adaptor for Audi, BMW, VW, Opel, Ford
- adaptor for Nissan Ø 49.5 mm, 34.5 mm
- adaptor for Honda Ø 56 mm
- adaptor for BMW, Audi Ø 44.2 mm



Item #
8316



Adaptor Set for Air Brake Bleeder | 4 pcs.

- for filling and bleeding brake systems through the brake fluid reservoir using brake service machines
- metal made
- uses standard European air connector
- for Air Brake Bleeder BGS 8315 and others

includes the following adaptors:

- adaptor Ø 90 mm, for Mitsubishi, Nissan (Gasoline), Subaru, Suzuki, Volvo S40 und V40
- adaptor Ø 55 mm, for Chrysler, Ford Explorer, Hyundai, Mazda 6, Subaru
- adaptor E20 with free moveable hose:
 - provides unrestricted access to limited spaces,
 - for European vehicles, especially for Ford C-Max, Fiesta, Focus, Galaxy, S-Max
- universal adaptor with fastening chain



Item #		
9152		

Adaptor for Brake Bleeder | E20

- suitable for MAZDA 3, VOLVO C30, S40 since 2004, V50FORD Focus as of 2008, Fiesta until 09.2008, C-Max, Galaxy as of 2006, Kuga, S-Max and other European cars with 46.5 mm filling opening
- with European 6.3 mm (1/4") adaptor
- made of aluminium, with angled hose connector for working in tight spaces



Item #	
9001	

Pneumatic Brake Bleeder Tool

- one-man operation, can also be used on clutch systems
- includes a hose for extracting liquids
- length: 225 mm
- width: 135 mm
- height: 192 mm
- operating pressure: 6 - 12 bar



Item #	Description
8066	Pneumatic Brake Bleeder Tool
8066-1	Bleeding Nipple for Brake bleeder for BGS 8066 / 8080

Bleeding Nipple for Brake bleeder | for BGS 8066 / 8080

- suitable for BGS 8066, 8080
- suitable for brake bleeding valve



Item #
8071-2

Double Hose Adaptor for Brake Bleeder | for BGS 8066

- suitable for BGS 8066
- for bleeding fixed multi-piston callipers, with 2 bleeding valves (such as motorcycles)
- silicone hoses
- incl. 2 bleeding adaptors with hooks
- hose length: 1060 mm - 1060 mm - 100 mm
- hose: internal diameter 3 mm / external diameter 7 mm

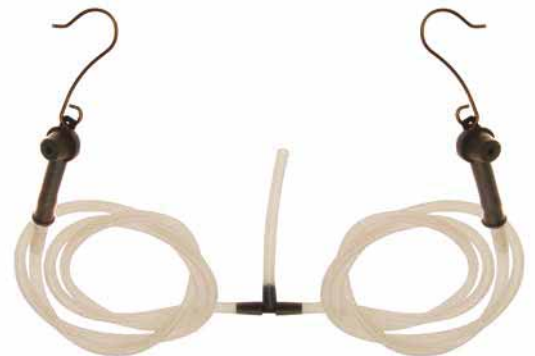

Item #
8066-3

Hose / Tube Connector Kit for Bleeding Diesel Systems

- for bleeding / filling of diesel injection systems
- suitable for hose / pipe connections
- to be used with e. g. BGS 8080, 8066, 3157, 3155
- 90° angled coupling
- straight coupling
- rubber pipe connector
- straight coupling adaptor



Item #
8066-2



Brake

Brake Bleeding Valve

- allows bleeding of brake and clutch systems without a second person
- valve opens automatically when pressing the brake and closes automatically when loosening the brake, this prevents the suction of air
- suitable for scooters, motorcycles, quads, cars, trucks etc.
- blue anodized aluminium



Item #
8403



Brake Bleeder Valve with Fluid Reception Bottle

- for bleeding brake and clutch systems
- non-return valve prevents ingress of air and allows a one-man bleeding
- suitable for scooters, motorbikes, quads, cars
- easy to use
- includes 1 l reception bottle
- 620 mm silicone hose



Item #
8403-1

Brake Bleeding Bottle | 1 l

- plastic bottle 1 l
- with holding chain and hook
- variable length bleeding hose
- bleeding nipple adaptor



Item #
8519

Brake Fluid Refill Bottle | 1 l

- helpful when bleeding of brake systems
- automatic refilling of the brake fluid tank
- with valve and clamp
- container size: 1 litre
- also as replacement for BGS 8080



Item #
8731

Brake Bleeding Hose with Valve | 1.2 m

- for bleeding of brake systems, especially on motorcycles
- made of silicone
- with non-return valve, no second person required when bleeding
- rubber adaptor for connection to the bleed nipple
- length: 1.2 m



Item #
8897



Brake Spanner Set | 6 pcs.

- forged
- brake pipe wrench 6.3 mm (1/4") square x 5/16" open end
- brake pipe wrench 6.3 mm (1/4") square x 10 mm square
- brake pipe wrench 9 mm hexagon x 11 mm hexagon
- brake pipe wrench 8 mm hexagon x 10 mm hexagon
- brake pipe wrench 6.3 mm (1/4") hexagon x 7 mm hexagon
- brake pipe wrench 7/16" open end x 11/32" square
- surface finish: chrome plated



Item #
1240

Brake Pipe Wrench with Ratcheting Function | 10 x 11 mm

- ring ends with ratcheting function
- both sides flexible
- rings can be opened to fit around a pipe
- an internal spring ensures the ring closes securely around the nut
- the more pressure you put on the tools in the driving direction, the tighter the head closes around the nut;
- this prevents slipping over the nut - wrench holds the long side of the nut, so it works also on nuts with damaged corners



Item #
1722

Special Flare Nut Wrench | 175 mm | 10 x 11 mm

- with strengthened hexagon ends
- double offset
- wrench size 1: 10 mm
- wrench size 2: 11 mm
- surface finish: chrome plated

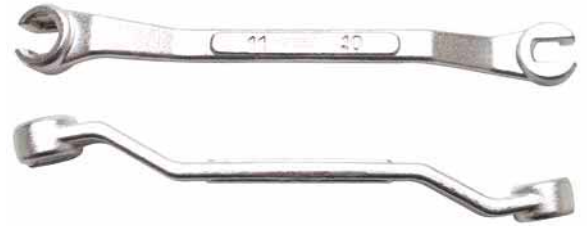

Item #
1760



Double Ring Spanner for Brake Lines and Joints

- especially suitable for brake line fittings
- swivel heads
- surface finish: satin chrome plated



Item #	Description
30412	Double Ring Spanner for Brake Lines and Joints 9 x 11 mm
30413	Double Ring Spanner for Brake Lines and Joints 10 x 12 mm

Brake Line Scraper | 160 x 14 x 6 mm

- for removing dirt or corrosion on the brake line surface
- made of composite plastic, prevents damage to the brake line
- length: 160 mm
- width: 14 mm
- height: 6 mm
- material: polyoxymethylene (POM)



Item #
8864



Brake Bleeder Wrench Set | 8 pcs.

- for easy bleeding of brake systems without removing the wheels
- ratchet wrench makes releasing and tightening easier
- hose remains on bleeding screw while loosening and tightening
- 6 special sockets: 9 x 29 mm - 9 x 75 mm - 10 x 29 mm - 10 x 75 mm - 11 x 29 mm - 11 x 75 mm
- incl. bleeding hose with 4 mm inner diameter



Item #	Description
66512	Brake Bleeder Wrench Set 8 pcs.
66512-1	Reversible Ratchet for BGS 66512
66512-2	Replacement Hose for BGS 66512

Brake Bleeder Wrench Set | 7 - 8 - 9 - 10 - 11 mm | 6 pcs.

- ideal for bleeding break and hydraulic clutch systems
- easy using without removing the wheels
- the spanners seal to the bleeding valve, preventing air from entering the system or brake fluid leaking out of the spanners
- 120 cm silicon hose with non-return valve
- includes 5 brake bleeding wrenches, 12-point, sizes: 7 - 8 - 9 - 10 - 11 mm



Item #		
66514		

Brake Bleeder Wrench Set | 8 - 10 - 11 mm | 4 pcs.

- for easy bleeding of hydraulic clutch systems and brake systems without removing the wheels
- allows one-person bleeding
- consisting of 3 brake bleeding wrenches, 22-point, sizes: 8 - 10 - 11 mm
- 120 cm silicon hose with non-return valve
- suitable for universal bleeder nipples



Item #		
66513		

Brake Bleeder Wrenches | N-Type | 7 - 11 mm

- N-type shape
- ideal for working in hard to reach areas



Item #	Description
1753-7	Brake Bleeder Wrench N-Type 7 mm
1753-8	Brake Bleeder Wrench N-Type 8 mm
1753-9	Brake Bleeder Wrench N-Type 9 mm
1753-10	Brake Bleeder Wrench N-Type 10 mm
1753-11	Brake Bleeder Wrench N-Type 11 mm



Adjuster for Brake and Accelerator Pedal

- needed for wheel alignment and is a practical tool for testing and adjusting brakes and throttle control



Item #
9976

Brake

Tool Tray 2/3: Brake Piston Wind Back Set | 50 pcs.

- for rewinding the brake piston e.g. when replacing the brake pads
- wind-back spindle (clockwise)
- wind-back spindle (counterclockwise)
- pin punches, Ø 5.4 mm
- pin punches, Ø 6 mm, with 3 mm pin
- 6 mm L-type hexagon wrench
- 8 mm L-type hexagon wrench
- impact socket, 6-point, 12.5 mm (1/2"), 19 mm
- impact socket, 6-point, 12.5 mm (1/2"), 14 mm
- bit socket, 12.5 mm (1/2"), 10 mm
- T-Star bit socket (for Torx), 10 mm (3/8"), T45
- 4 counterholding plates
- 35 wind-back adaptors, suitable for most models like BMW, VW, Skoda, Seat, Ford, Honda, Alfa Romeo, Suzuki, Nissan, Toyota, etc.
- width: 378 mm
- height: 32 mm
- depth: 408 mm



Item #		2/3
1102		

Brake Piston Reset Set | 18 pcs.

- for manual resetting of brake pistons
- right threaded and left threaded wind back tool
- suitable for many car models
- includes list of matching car models



Item #	Description
1119	Brake Piston Reset Set 18 pcs.
1119-LEER	Empty Case for BGS 1119

Brake Piston Reset Tool Set | 14 pcs.

- for manual resetting of brake pistons
- right threaded wind back tool
- suitable for many car models
- includes list of matching car models



Item #
1127

Brake

Air Brake Piston Wind back Tool

- for left- & right-side thread - the direction is determined by moving the angled lever at the end of the hydraulic spindle
- fits for all thread pitches
- to be used with BGS 1114, 1117, 1119, 1127
- 6.3 mm (1/4") compressed air connection



Item #
1114-1



Brake Piston Reset Tool Set | pneumatic | 22 pcs.

- universal set for turning and pressing brake pistons on almost all car models
- for air pressure assisted resetting of brake pistons
- hand lever for rotary function, suitable for left and right turns
- also suitable for brake callipers with hand brake function
- suitable for following car models: Alfa Romeo, Audi, Citroen, Fiat, Ford, GM Honda, Jaguar, Lancia, Land Rover, Mazda, Nissan, Peugeot, Renault, Rover, Saab, Seat, Subaru, Toyota, Volvo, VW
- includes 21 resetting adaptors, also 3- and 4-pin adaptor for newer vehicles
- working pressure: 5 to max. 8 bar



Item #
1114



Brake Piston Reset Tool Set | pneumatic | 16 pcs.

- universal set for turning and pressing brake pistons on almost all car models
- for air pressure assisted resetting of brake pistons
- hand lever for rotary function, suitable for left and right turns
- fits for all thread pitches
- suitable for following cars: Alfa Romeo, Audi, Citroen, Fiat, Ford, GM, Honda, Jaguar, Lancia, Land Rover, Mazda, Nissan, Peugeot, Renault, Rover, Saab, Seat, Subaru, Toyota, Volvo, VW, Opel
- includes 15 resetting adaptors, also 3- and 4-pin adaptor for newer vehicles
- working pressure: 5 to max. 8 bar
- 3 brake piston wind back adapters suitable for GM models
- 1 brake piston wind back adapters suitable for Citroen, Honda
- 1 brake piston wind back adapter suitable for Audi / Fiat / Alfa Romeo / Ford / Isuzu / GM / Honda / Jaguar / BMW / Mercedes-Benz / Mitsubishi / Nissan / Rover / Toyota / Volvo / VW
- 1 brake piston wind back adapter suitable for Mazda / Saab / Toyota / Fiat / Alfa Romeo / Honda / GM
- 1 brake piston wind back adapter suitable for 10 mm (3/8")
- 1 brake piston wind back adapter suitable for Nissan / VW Golf
- 1 brake piston wind back adapter suitable for Citroen
- 1 brake piston wind back adapter suitable for Audi / Subaru / Ford / Mini / Honda / Alfa Romeo / Audi / VW / Lancia / Mazda / Nissan / Peugeot / Toyota / VW Golf / VW Passat / VW / Citroen / Fiat / Jaguar / Renault / Saab / Seat
- 1 brake piston wind back adapter suitable for Saab / Honda / Alfa Romeo / Audi / VW / Lancia
- 1 brake piston wind back adapter suitable for Opel
- 1 brake piston wind back adapter suitable for Nissan / Ford
- 1 brake piston wind back adapter suitable for Ford / Mini / Mazda
- 1 brake piston wind back adapter suitable for Renault
- 1 air brake piston wind back tool



Brake

CE

Item #	Description
1117	Brake Piston Reset Tool Set pneumatic 16 pcs.
1117-LEER	Empty Case for BGS 1117

Air Brake Piston Wind back Tool

- for left- & right-side thread - the direction is determined by moving the angled lever at the end of the hydraulic spindle
- fits for all thread pitches
- to be used with BGS 1114, 1117, 1119, 1127
- 6.3 mm (1/4") compressed air connection



Item #
1118



Brake Piston Reset Tool | universal | left + right Thread | 6 pcs.

- for resetting the brake piston when replacing the brake pads
- suitable for most diesel engines
- 1 adjustable 2-pin brake piston adaptor
- 1 adjustable 3-pin brake piston adaptor
- 1 magnetic adaptor plate for mounting standard brake piston adaptors with fixed pins
- 1 counterholding plate
- 1 two-way adaptor driver



Item #
9159

Brake Piston Wind Back Adaptors

- suitable for all BGS brake piston wind back tool sets

Item #	Description
11011	Brake Piston Reset Adaptor 0 for GM
11014	Brake Piston Reset Adaptor 2 for Citroen / Honda / Mercedes
11015	Brake Piston Reset Adaptor 3 for VW / Land Rover / Audi
11016	Brake Piston Reset Adaptor 4 for Alfa Romeo / Fiat / Ford
11017	Brake Piston Reset Adaptor 5 Adaptor 10 mm (3/8")
11018	Brake Piston Reset Adaptor 6 for VW / Nissan / Jaguar
11019	Brake Piston Reset Adaptor 7 for Alfa Romeo / Audi / Citroen
11020	Brake Piston Reset Adaptor 8 for GM
11013	Brake Piston Reset Adaptor 9 for GM
11008	Brake Piston Reset Adaptor A / Z for Renault / BMW Mini
11007	Brake Piston Reset Adaptor E for Ford / Nissan
11009	Brake Piston Reset Adaptor F / G for Opel
11006	Brake Piston Reset Adaptor K for Citroen
11010	Brake Piston Reset Adaptor M for Ford / BMW Mini / Nissan
11012	Brake Piston Reset Adaptor N for Alfa Romeo / Audi / Lancia
1119-1	Brake Piston Reset Adaptor for VAG, Ford, Renault with electric handbrake
1106	Brake Piston Reset Adaptor for Golf V/VI

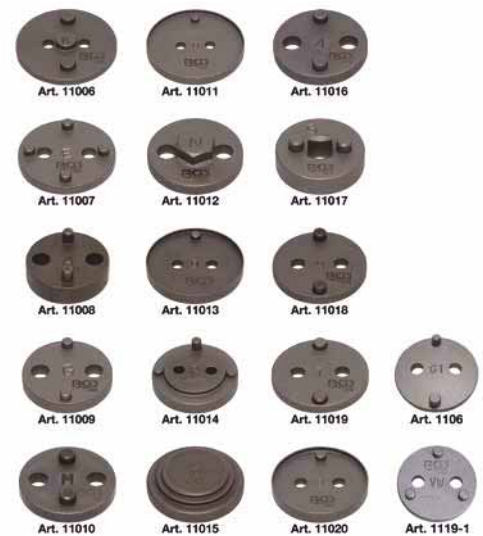

Brake

Pressure Plate

- suitable for BGS 1102, 1119, 1127, 1104

Item #
11000



Spindles for Brake Piston Wind-Back Sets

- replacement for wind-back tool from BGS wind-back-sets
- can be used with all pressure plates contained in BGS sets Nr. 1102, 1104, 1119, 1127

Item #	Description
1120	Spindle for Brake Piston wind-back Set right-turning
1121	Spindle for Brake Piston wind-back Set left turning



Brake Piston Reset Tool | spring loaded

- for winding back brake pistons on rear axle brake callipers with hand brake function
- spring-loaded rotation axis, suitable for the left- and right-hand threaded pistons
- fits all separately available BGS brake piston adaptors and brake piston adaptors in BGS brake piston wind back tool sets

Item #
9395



Brake Piston Reset Tool | universal

- for winding back brake pistons of bigger vehicles
- for eg. Mercedes-Benz S-class, BMW 7-series, Porsche, SUV's
- for fixed caliper brakes with more than two brake pistons

Item #
1123



Brake Piston Reset Tool | universal Type

- universal brake piston resetting tool for pistons which can be reset without turning
- spreading width: 13 - 87 mm



Item #
1126

Brake Piston Reset Tool | with double guide | universal Type

- for pushing back the brake pistons on e.g. front brake callipers
- suitable for most cars and vans
- two guides for very stiff pistons
- made of cast steel with carbon steel spindle



Item #
67309

Brake Piston Reset Tool | with Ratchet Function

- for damage-free resetting of brake pistons
- allows centered, tilt-free resetting
- no damage to seals, pistons and cylinders
- required for maintenance and brake pad replacement
- suitable for almost all vehicle types with floating and fixed callipers without integrated handbrake function
- spindle ratchet mechanism (reversible) reduces the effort
- solid construction with hardened resetting plates
- dip coated handle
- working range from 40 - 68 mm
- length: 270 mm



Item #
1101

Brake Piston Reset Tool | for VW T5

- special tool for VW T5
- with spindle and adapter



Item #
1113

Brake Piston Reset Tool | 10 mm (3/8")

- for turning back the brake pistons on brake systems with hand brake detection
- universal type
- 10 mm (3/8") drive

Item #
1124



Reamer Set | for ABS Sensor Hole

- for cleaning the ABS sensor-mounting holes
- removes debris such as corrosion, dirt and residue of old ABS sensors
- prevents damage to the new sensors and ensures a precise fit

includes the following reamers, suitable for:

- VAG, utility vehicles - Ø 18 mm x 34 mm
- VAG, BMW E36, E46 - Ø 18 mm x 23 mm
- Mercedes A-Class, Ford and Mazda - Ø15 mm x 23 mm
- BMW E38, E39, E52, E60, E61, E63, E64, E65, E66, E67, E70, E71 - Ø14 mm x 322 mm
- Skoda Fabia, Seat Ibiza, Opel Insignia, VW Golf V, Polo 9N, T5 - Ø 10 mm x 29 mm
- swivel head ratchet 6.3 mm (1/4") drive, 123 mm length
- 10 mm HSS drill



Item #
65525

Reamer Set | for ABS Sensors

6.3 1/4

- it is recommended to use the reamers before replacing the ABS sensors
- suitable for Mercedes, Ford, Daewoo, Audi, BMW, Peugeot, Renault, VW and other cars
- reamer Ø18 mm x length 23 mm and Ø15 mm x length 23 mm
- 6.3 mm (1/4") T-handle
- reamers can also be used with 6.3 mm (1/4") ratchet

Item #	Description
65520	Reamer Set for ABS Sensors
65521	Reamer for BGS 65520 Ø 15 mm, length 23 mm
65522	Reamer for BGS 65520 Ø 18 mm, length 23 mm



Repair Kit for Brake Threads | for VAG | M12 x 1.5 | 15 pcs.

- suitable for VAG models
- 1 step drill
- 1 drilling template with pilot
- 1 hand tap
- 1 hexagon wrench
- 1 bearing
- 10 thread sleeves



Item #	Description
8408	Repair Kit for Brake Threads for VAG M12 x 1.5 15 pcs.
8408-1	HSS Drill for BGS 8408 110 x 10 mm for BGS 8408
8408-3	Tap Set M12 x 1.5 for BGS 8408
8408-2	Thread Sleeve M12 x 1.5 for BGS 8408

Repair Kit for Brake Threads | M9 x 1.25 | 16 pcs.

- 10 replacement threads
- 1 step drill
- 1 tap
- 1 L-type wrench
- 1 drilling gauge for VAG, 91 mm
- 1 drilling gauge for Opel, 94 mm
- 1 drilling gauge for Ford, 105 mm
- for thread/pitch: M9 x 1.25



Item #	Description
148	Repair Kit for Brake Threads M9 x 1.25 16 pcs.
148-3	Tap Set M9 x 1.25 for 148
148-2	Step Drill for BGS 148
148-1	Thread Replacers for BGS 148 M9 x 1.25

Universal Repair Set | for Brake Calliper Bleeding Valves | 1/4" & 1/8" NPT

- is used for boring out demolished bleed valves
- the valve is bored out completely including its thread and replaced by a threaded bush with a new bleed valve
- suitable for e.g. Audi, VW, Opel, etc.
- twist drill 6.0 mm, HSS
- twist drill 8.5 mm, HSS
- core drill tool, 11 mm, titanium nitrate surface
- hand tap 1/8" x 27 NPT, HSS
- hand tap 1/4" x 18 NPT, HSS
- countersink 90°, HSS
- bleed valve repair inserts 1/4" NPT (2 pcs.)
- bleed valve repair inserts 1/8" NPT (2 pcs.)



Item #	Description
9346	Universal Repair Set for Brake Calliper Bleeding Valves 1/4" & 1/8" NPT
9346-1	Valve Repair Inserts 4 pcs.

Guide Bolt Repair Set | for Brake Calliper Carriers

- used for repairing faulty inner threads on brake calliper guide bolts in wheel bearing housings / brake calliper carriers
- reduces repair costs to the minimum
- wheel bearing housing and wheel bearing do not need to be replaced
- dismantling of wheel bearing, strut and a wheel alignment are not required
- suitable for models from VAG, Ford and Opel
- 1 twist drill
- 1 tap M10x1.25
- 10 calliper guide bolts



Item #
9347

Brake Calliper Socket Set | 5-point (pentagon) | 5 pcs.

12.5 \square 1/2

- for e. g. disassembly of brake callipers
- includes the following 5-pt. (pentagon) sockets:
- 10 mm pentagon socket
- 12.5 mm pentagon socket
- 14 mm pentagon socket, suitable for brake callipers on Mercedes-Benz, Smart, Opel Astra G and Zafira
- 19 mm pentagon socket, suitable for parking brake on Citroen, Renault, Peugeot
- 10 mm pentagon bit socket, suitable for Girling brake systems



Item #
1112-1



Brake Calliper Special Socket Set | 12.5 mm (1/2") | 3 pcs.

12.5 \square 1/2

- 14 mm pentagon socket fits Opel / Vauxhall (Astra G, Zafira), Mercedes-Benz, Smart
- 19 mm pentagon socket fits Peugeot, Renault
- 10 mm pentagon bit socket for Girling brakes



Item #
1112



Brake Calliper Socket | 10-point | for VAG and Porsche

10 \square 3/8

- required for replacing the brake pads
- suitable for 6-piston fixed brake callipers on Porsche, VW Touareg, Audi Q7
- size: 9 mm 10-pt.
- drive 10 mm (3/8")
- length: 30 mm



Item #
8981



Brake Calliper Sockets | Internal hexagon | extra short

6.3  1/4 10  3/8

- for loosening / tightening axle nuts on brake calipers
- extremely low profile: 24 mm
- **BGS 4995, 7 mm internal hexagon**
with 10 mm (3/8") drive
especially suitable for rear brake caliper bolts
on Mercedes Benz C-Class models
- **BGS 4996, 8 mm internal hexagon**
with 10 mm (3/8") drive
especially suitable for screw connections on rear brake calipers
on Audi A4, A6, A8 models
- **BGS 4997, 8 mm internal hexagon**
with 6,3 mm (1/4") drive
especially suitable for screw connections on rear brake calipers
on Audi A4, A6, A8 models



Item #	Description
4995	Brake Calliper Socket internal Hexagon extra short 7 mm
4996	Brake Calliper Socket internal Hexagon extra short 8 mm
4997	Brake Calliper Socket internal Hexagon extra short 8 mm

Brake

Pentagon Socket Set | 12 mm Drive | 4 pcs.

- for resetting the piston adjuster
- required when changing brake pads
or other work on the brake calliper
- suitable for SAF / Knorr and
brake callipers for other commercial vehicles
- drive: 12 mm external hexagon with magnet
- sizes:
 - hexagon 8 mm
 - hexagon 10 mm
 - Square 8 mm
 - 11-point



Item #
9412

Brake-Calliper Brush | brass | bent | 230 mm

- for cleaning aluminum brake callipers
- soft brass bristles facilitate damage-free cleaning
- silm design allows working in areas with restricted access
- 2 component plastic handle with hanging hole
- size: 90 x 22 mm



Item #
1793-1



Brake Calliper Brush | bent | 230 mm

- for cleaning aluminium callipers
- soft brass bristles facilitate damage-free cleaning
- slim design allows working in areas with restricted access
- 2 component plastic handle with hanging hole
- size: 90 x 22 mm

Item #
1793



Brake Calliper Brush | brass | 220 mm

- for cleaning aluminium brake callipers
- soft brass bristles facilitate damage-free cleaning
- slim design allows working in areas with restricted access
- plastic handle with hanging hole

Item #
1798-1



Brake Calliper Brush | steel wire | 220 mm

- for cleaning brake callipers
- slim design allows working in areas with restricted access
- steel wire, straight
- plastic handle with hanging hole

Item #
1798



Brake caliper file | Square | 260 mm

- for cleaning brake callipers
- all sides with deep and rough diagonally positioned rasps
- helical tothing
- flat hand
- broken angles
- 2-component handle

Item #
1792



Brake Saddle Assembly Tool | for VAG, Porsche | 2 pcs.

- for use on radial brake callipers
- allows safe replacement of the brake pads
- prevents damage to ceramic brake discs
- suitable for:
 - Porsche Cayenne
 - VW Touareg
 - Audi Q7
- to be used as OEM T10439

Item #
8929



Brake Pedal Release Tool | for VAG

- separates brake pedal from brake servo
- suitable for many models from Audi - Seat - Skoda - VW
- to be used as OEM T10159B / T10159A

Item #
9527

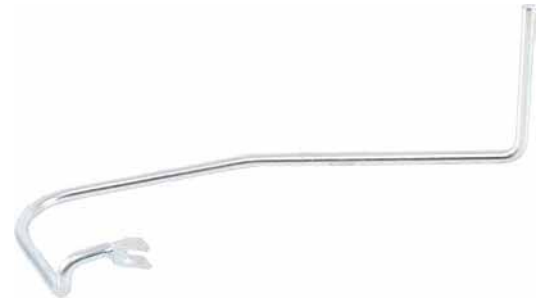

Assembly Hook

- for brake spring and headlight spring assembly
- material: steel, alloyed
- surface finish: black

Item #
8018



Brake Calliper Sealing Groove Cleaner Set | 2 pcs.

- for cleaning the sealing groove of brake callipers
- high degree of hardness, allows scraping of dirt and rust
- includes 2 cleaning tools with different tip shape
- length: approx. 200 mm

Item #
9171



Punch Set for Brakes | 28 pcs.

- especially suitable for where precise work is needed
- without handle (straight type)
- in metal holder
- punch set: Ø 2.4 - 2.8 - 3.2 - 3.6 - 4.0 - 4.4 - 4.8 - 5.25 - 5.6 - 6.0 - 6.4 - 6.7 - 7.1 - 7.5 - 7.9 - 8.3 - 8.7 - 9.1 - 9.5 - 9.9 - 10.3 - 10.7 - 11.1 - 11.5 - 11.9 - 12.3 - 12.7 - 13.5 mm
- length: 123 mm
- material: carbon steel

Item #
2029



L-Type Wrench for Brake Calliper | internal Hexagon 7 mm

- profile: internal hexagon 7 mm

Item #
1122



Brake Lining Wear Indicator Set | Aluminium | 8 pcs.

- for quick assessment of the brake pad thickness on disk brakes
- colour coded
- scale: metric, with indication on each brake lining wear indicator
- measuring range: 2 mm up to 12 mm



Item #
9440



Brake Disc Calliper | 60 mm

- stainless steel
- measuring range 60 mm
- in plastic case



Item #	Description
1937	Brake Disc Calliper 60 mm
1937-LEER	Wood Case for BGS 1937

Brake Disc Calliper | 60 mm

- for measuring the brake disc thickness, tire tread depth etc.
- max. measuring depth: 60 mm
- dimensions: 182 x 115 x 13 mm
- material: aluminium



Item #
8689



Digital Brake Disc Vernier Calliper | 80 mm

- extra-long and slim design
- especially suitable for measuring brake discs without dismantling the wheel
- large and easy-to-read LCD display
- low battery indicator
- automatic power-Off
- measuring arm depth: 28 mm
- measuring range can be switched from inch to metric
- measuring range: 0 - 80 mm (0 - 3.2")
- resolution: 0.01 mm (0,0005")
- resolution: +/- 0.025 mm (+/- 0.001")
- made from hardened stainless steel
- incl. 3 Volt CR2032 battery
- in plastic case



Item #
9177



Digital Brake Disc Vernier Calliper | 140 mm

- measuring range up to 140 mm / 5,5 inch
- hold-function
- digital measurement in mm and inch
- with battery CR2032-3V
- with conversion scale in plastic box

Item #
1943



Brake Disc Vernier Calliper | 200-400 mm

- for measuring the brake disc diameter without disassembling the wheels
- allows quick and efficient identification of the brake system and eliminates the risk of ordering wrong brake parts
- all-purpose
- overall length: 455 mm
- measuring range: 200 - 400 mm

Item #
9392



Brake Drum Tool Kit | 6 pcs.

- brake piston spanner
- brake spring pliers with moveable wheel clamp
- hose clamp
- brake piston clips
- hand brake cable pliers

Item #
1833



Brake Maintenance and Assembly Tool Set | 15 pcs.

- universal set for drum and disc brake systems
- brake spring pliers with movable claw for removing and installing of brake shoe springs
- brake spring pliers for installing and removing the brake shoe recuperating spring, forged type
- brake calliper brush for removal of brake dust and dirt from the brake callipers
- brass brake calliper brush for cleaning of brake dust from aluminium brake callipers
- special tool for brakes for installing and removing spring plates and the holding device of brake linings e.g. on VW, Seat, Skoda, Opel and Renault
- brake calliper file, extra slim style, for removal of brake dust rust and dirt from the brake calliper
- brake line flare nut wrench with enforced 6-pt. openings, straight hexagon slot, 10 x 11 mm
- assembly tool for installing and removing the draw spring, e.g. on Mercedes-Benz, VW LT as of 1997
- brake spring installer for pressure spring of the parking brake
- brake cable spring pliers for the installation and removal hand brake cable
- universal joint bit socket, 10 mm (3/8") drive, internal hexagon 10 mm
- bit socket, length 110 mm, 12.5 mm (1/2") drive, internal hexagon 6 mm
- bit socket, length 100 mm, 12.5 mm (1/2") drive, internal hexagon 7 mm
- bit socket, length 80 mm, 12.5 mm (1/2") drive, internal hexagon 8 mm
- screwdriver, length 265 mm, cross slot drive PH3



Brake



Item #	Description
1818	Brake Maintenance and Assembly Tool Set 15 pcs.
1818-1	Joint Socket 10 mm (3/8") Drive internal Hexagon 7 mm

Brake Shoe Spring Extraction Tool

- for easy disassembly of the retaining spring on brake shoes
- suitable for spring plate diameters of 14 to 20 mm
- easy and safe handling
- diameter 34 mm
- length: 240 mm

Item #
8308



Brake Spring Assembly Tool with Aluminium Handle

- zinc coated
- for assembling and removing braking plate springs

Item #
1135



Brake Spring Installer | for Mercedes-Benz Parking Brake | 140 mm

- especially for Mercedes parking brake
- for disassembly and assembly of spring clips on brakes (rear disk brakes)



Item #
1791



Brake Spring Pliers with Claw | 330 mm

- with movable claw for riveted and glued pads



Item #
1817



Brake Cable Spring Pliers | 215 mm

- for assembling and removing hand brake cables on brake shoes
- joints and fork black finished
- nickel plated handles



Item #
1831



Brake Cable Spring Pliers | 210 mm

- for removing brake drum springs



Item #
1832



Spring Plate Pliers | for Drum Brakes

- for removal of spring plates on brake shoes of drum brakes
- self-opening due to the spring mechanism
- for spring plates from 7-30 mm
- angled shape
- suitable for difficult to reach places



Item #
8642

Brake Drum Gauge | 160 - 360 mm

- suitable for brake drums, sizes between 160 - 360 mm
- for outer and inner measurements
- with fine adjustment

Item #
1939



Holding Tool | for Drum Brake Pistons | 4 pcs.

- facilitates assembly of the brake shoes
- holds the brake piston in the cylinder
- prevents brake fluid leakage
- suitable for brake piston distance 50 - 80 mm

Item #
9028



Radio Removal Tool Set | 32 pcs.

- removal tool set for most brands and makes of auto radios and GPS systems
- 4 P-01 - for Mercedes-Benz, VW, Audi, Becker
- 2 P-02 - for Mercedes-Benz, Porsche, Becker
- 2 P-03 - for VW
- 2 P-04 - for Skoda
- 2 P-05 - for Becker
- 2 P-06 - for Clarion
- 2 P-07 - for PK Clarion
- 2 P-08 - for RK-Kenwood 01
- 2 P-09 - for Sony
- 2 P-10 - for RK-Kenwood
- 2 P-11 - for Fiat Bravo, Brava
- 1 Screwdriver - for BMW
- 1 hexagon key - for BMW, Opel
- 1 set of special hooks for Opel, Grundig, Blaupunkt
- 1 set of special hooks for VW, Audi, Ford
- 1 set of special hooks for Blaupunkt

Item #
8014



Radio Removal Tool Set | 18 pcs.

- for the assembly of radios and GPS systems, for most car types and brands:
 - old and new radios from Blaupunkt
 - old and new radios from Becker
 - radios from Grundig
 - original radios in Porsche models
 - original radios in Mercedes-Benz models
 - original radios in Audi models
 - original radios in Ford models
 - original radios in BMW and Opel models
 - original radios in VW models
 - original radios in new Skoda models
- in plastic pouch



Item #
8011

Radio Removal Tool Set | 2 pcs.

- for the most common car stereo brands
- folds to a handy size

suitable for the following brands:

- P01 - Mercedes-Benz, VW, Audi, Becker, Renault, Alpine
- P02 - Mercedes-Benz, Porsche, Becker
- P03 - VW
- P04 - Skoda
- P05 - Becker
- P07 - Clarion, new models
- P08 - Kenwood 2002
- P09 - Sony
- P10 - Kenwood 98 2001
- P11 - Fiat Bravo, Brava
- P14 - Panasonic
- 1 internal hexagon wrench for BMW
- 1 hook for Fiat, Grundig, Blaupunkt, Ford, PSA, Renault, Alfa, VW, Audi
- 1 hook for Blaupunkt, Peugeot, Clarion



Item #
8247



Airbag Tool Kit | 12 pcs.

- includes 2 special T30 Bits (tamperproof and non-tamperproof) for Torx screws
- for disassembling the air bag unit as well as assembling & disassembling airbag pads

suitable for the following models:

- VW Bora, Golf, Jetta, Lupo, New Beetle, Passat, Polo
- Audi A4, A6
- BMW
- Mercedes-Benz
- Vauxhall
- Renault
- Seat as of 1999
- Škoda Fabia, Oktavia, Superb



Item #	Description
8147	Airbag Tool Kit 12 pcs.
8147-T30	Bit Socket 6.3 mm (1/4") Drive T-Star (for Torx) T30

Cable Splice Release Tool Set | universal | 12 pcs.

- removes wires from vehicle terminal blocks without any damage to the electronics (ABS, air conditioning system, sensors, etc.)
- for round and flat terminal blocks
- suitable for most car types, e.g. VW, Opel, Ford, Mercedes-Benz, BMW, etc.
- protective caps prevent damage to the blades when not in use

1 extraction tool each for:

- round plug contacts Ø 1.5 mm
- round plug contacts Ø 2.3 mm
- round plug contacts Ø 3.5 mm
- standard flat plug contact 1.48 mm
- Micro-timer flat plug contact 1
- Micro-timer flat plug contact 2+3
- Maxi-Power-Timer flat plug contact
- PIT POD flat plug contact
- JPT/SPT3 flat plug contact

- replacement sleeves



Item #	Description
60100	Cable Splice Release Tool Set universal 12 pcs.
60100-CE56	Cable Splice Release Tool CE56
60100-CE91	Cable Splice Release Tool CE91
60100-1	Replacement Sleeve for BGS 60100 3 pcs.

Terminal Tool Set | for VAG, Porsche | 11 pcs.

- removes wires from vehicle terminal blocks without any damage to the electronics (ABS, air conditioning system, sensors, etc.)
- for round and flat terminal blocks
- special set for VAG
- protective caps prevent damage to the blades
- also suitable for some connectors in BMW, Daimler, Chrysler, Fiat, Ford, Honda, Jaguar, Opel, Mazda, Mercedes-Benz, Mitsubishi, Porsche PSA, Renault, Saab, Toyota, Volvo, VAG
- for round contacts with diameter 1.5 / 2.3 / 3.5 mm
- for contacts with one locking lug 6.3 / 0.63 / 1.6 / 2.8 / 5.8 mm
- for contacts with two symmetrical locking lugs in 1.6 / 2.8 / 5.8 / 9.5 mm
- for contacts with two asymmetrical locking lugs in 2.8 mm



Item #
60120

Terminal Tool Set | for MAN, Volvo | 14 pcs.

- removes wires from vehicle terminal blocks without any damage to the electronics (ABS, air conditioning system, sensors, etc.)
- for round and flat terminal blocks
- special set for MAN and Volvo
- protective caps prevent damage to the blades.
- also suitable for some connectors in BMW, Daimler, Chrysler, Fiat, Ford, Honda, Jaguar, Opel, Mazda, Mercedes-Benz, Mitsubishi, Porsche PSA, Renault, Saab, Toyota, Volvo, VAG
- for round contacts with diameters 1.5 / 3.5 / 4.0 / 2.5 / 4.0 mm
- for contacts with one locking lug 2.8 / 5.8 mm
- for contacts with two symmetrical locking lugs in 2.8 / 5.8 / 2.8 mm
- for contacts with multiple locking lugs in 1.5 / 2.5 mm



Item #
60150

Terminal Tool Kit | 23 pcs.

- universal assortment for virtually all vehicles
- for damage-free unlocking of terminals and connectors, e.g. for ABS, climate sensors, radios, PDC, trailer coupling modules, and much more
- faults due to corrosion or connection defects can be repaired quickly
- suitable for round and tab contacts
- indispensable for technicians and vehicle electricians



Item #
60160

Relay Pliers

- for removing and mounting of automotive relays
- especially suitable for tightly plugged relays
- suitable for most relay types
- fibre glass / plastic handles
- self-opening, spring-loaded



Item #	Description
8312	Relay Pliers straight
8313	Relay Pliers 45° offset

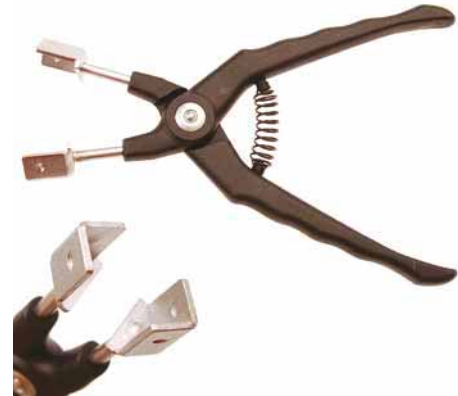

Taillight Removal Tool Set | 2 pcs.

- for effortless, damage-free disassembly of car lights
- universal application for light covers with clips (not for screwed ones)
- non-slip handle provides secure gripping, length: 118 mm
- plastic probes avoids scrapes
- disassembly tool: straight type, length: 198 mm, width: 17 mm, thickness: 1.2 mm, with 0.7 mm plastic probe
- disassembly tool: angular type, length: 205 mm, width: 17 mm, thickness: 1.2 mm, with 0.7 mm plastic probe

Item #
8851



Airbag Removal Tool | for Opel Insignia, Astra

- for releasing the driver airbag
- angled blade allows easy unlocking of the air bag holder, which can be reached through the hole behind the steering wheel
- suitable for e.g. Opel Astra (J), Insignia

Item #
8976



Connector Disassembly Tool | for VAG

- for safe and proper removing of most VAG push & pull connectors e.g. electrical connector on mass air flow sensor (MAF), pressure sensor (MAP), ignition coil pack, headlight, fog light, level sensor, etc.

can be used for following car types:

- VW / Audi / Skoda / Seat / Porsche

Item #
9172



Cigarette Lighter Release Tool for VAG

- for removing power supply sockets (cigarette lighters)
- suitable for the following Audi models, for example: A4 (2001), A4 (2008), Q5 (2008), A6 (2005), Q7 (2007)
- to be used as OEM T40148



Item #
9203

Front Light Adjusting Tool | for VAG

- for adjusting the front head light
- external 12-point, Ø 14.4 mm, with 5 mm guide pin

suitable for:

- Audi A4 (8K), A6 (4G), A5 (8T)
- VW Passat, Touareg



Item #
9205



Cable Installation Piercing Awl | 218 mm

- for piercing rubber seals
- cable can be put through the handle into the hollow the piercing awl
- for cable thicknesses up to Ø 6 cm
- handle type: 2-component handle
- length of awl: 104 mm



Item #
8641



Piercing Awl | 175 mm

- for piercing rubber, plastic, etc.
- hardened tip
- handle type: 2-component handle
- length of awl: 70 mm

Item #
67203



Digital Stroboscopic Gun | for Gasoline Engines

- electronic angle adjustment allows for precise flash of the markers
- especially suitable for engines that have no angle mark on the pulley
- further measurements are possible over the easy-to-read 7-segment display:
 - dwell at 2, 3, 4, 5, 6 and 8-cylinder engines
 - voltage and power loss test
 - engine speed
- firing angle: 0 to 60°
- drive speed: 200 to 9990 rpm
- dwell: 0 - 99.9%



Item #
40106



Digital Stroboscopic Gun | for Gasoline and Diesel Engines

- electronic angle adjustment allows precise flash of the markers
- especially suitable for engines that have no angle mark on the pulley
- further measurements are possible over the easy-to-read 7-segment display:
 - dwell at 2, 3, 4, 5, 6 and 8-cylinder engines
 - voltage and power loss test
 - engine speed
- also used for testing the start of diesel injection
- signal is picked up by a piezoelectric transducer to be mounted on the diesel line
- firing angle: 0 to 60°
- drive speed: 200 to 9990 rpm
- dwell: 0 - 99.9%
- power supply: 12 V



Item #
40107



Automotive Sensor Simulator

- for simulating signals of automotive sensors
- for finding hard-to-diagnose faults

possible outputs:

- DC voltage: 0.1 to 5 volts, increment: 0.1 V
- sine-like signal: 1 Hz to 300 Hz (5 volts), 1 Hz increment at 1 - 100 Hz, 10 Hz increment at 100 - 300 Hz
- rectangular-like signal: 1 Hz to 1 KHz (5 volts), 1 Hz increment at 1 - 100 Hz, 10 Hz increment at 100 - 1000 Hz, for the simulation of e.g. MAP sensors
- resistance: 100 ohm - 20 kohm, for the simulation of temperature sensors
- lambda probe signal, simulating the following 3 signals:
 - 1. permanently rich
 - 2. permanently lean
 - 3. alternating rich/lean
- crankshaft position sensor signal
- camshaft position sensor signal

scope of delivery:

- 1 simulator
- 1 double measuring cable (red/black), 900 mm
- 1 measuring cable (red), 4 mm plugs (stackable), 900 mm
- 1 measuring cable (black), 4 mm plugs (stackable), 900 mm
- 3 measuring adaptor (red), 4 mm round socket to timer socket
- 3 measuring adaptor (black), 4 mm round socket to timer socket
- 3 measuring adaptor (red), 4 mm round socket to timer plug
- 3 measuring adaptor (black), 4 mm round socket to timer plug
- storage bag
- instruction manual



Item #
63404



Electronic Brake Resetting and Diagnostic Device | EPB / SBC

- application:
 - EPB / SBC trouble code reading and clearing
 - SBC / EPB system activation and deactivation
 - inspection of brake systems
 - position of rear brake piston must be set before and after changing brake discs, pads etc.
- suitable for Audi A8 (2004 - 2012), VW Passat (2005 - 2012), Mercedes 211, 221
- 9-V-monobloc battery

accessories:

- instruction manual
- test cable for connecting the tester to vehicle

- length: 209 mm
- width: 107 mm
- height: 37 mm
- display: 128 x 64 pixels
- operating temperature: 0 - 60 °C



Item #
8385



OBD II (EOBD) Trouble Code Reader

- allows reading and deleting OBDII trouble codes
- no trouble code list required, all trouble codes are displayed in plain text
- viewing the freeze frame values is an important feature to locate a fault
- reading of readiness codes indicates if emission systems are ready or not
- enables reading live data, various parameters are shown in real time
- power supply via OBDII cable from the vehicle
- easy to use
- menu languages: German, English
- OBDII error codes = motor control error codes, a reading of comfort and safety systems such as airbags, ABS, radio, heated seats, etc. is not possible



Item #
63311



Tachometer

- digital display
- photoelectric
- measuring range 5 – 99,999 rpm
- accuracy +0.05 % +1d
- in plastic case



Item #	Description
2188	Digital Tachometer
2188-1	Reflector strips for BGS 2188

Ignition-Timing Tester for Classic / Vintage Cars

- for checking the ignition spark



Item #
3030



Hydraulic Drive Shaft Puller Set | 125 - 215 mm

- for pushing out the prop shafts or removing the wheel hub
- strong puller for cars, vans and vehicles with a bolt circle diameter of 125 - 215 mm
- especially suitable for glued or rusty drive shafts
- pressure force of the hydraulic cylinder is 10 t, can be used with impact spindle instead (included)
- quick and easy adjustment of the pulling lefs and diameter
- suitable for wheel hubs with 3, 4, 5, and 6 holes
- hydraulic spindle 10 t, 1 1/2" thread and pressure tip, sliding handle with 22 mm hex drive, length 250 mm
- impact spindle with movable bolt 30 mm hex drive, length 285 mm
- impact wrench with 30 mm hex drive for striking spindle, length 200 mm
- 35 mm spindle extension (for hydraulic ram)
- centering tip for hydraulic spindle
- 101 mm adaptor disc for puller arms and hydraulic spindle
- 5 puller arms
- length: 175 mm



Item #
7681

Wheel Hub Puller with Sliding Hammer | 6 pcs.

- forged type
- for pulling cut the wheel hub
- thread size of inner thread on sliding hammer is 9/16" x 12G
- thread size of inner thread of pulling foot is 5/8" x 18G
- total length with assembled pulling foot is approx. 510 mm
- the different threads can be used with the included adaptor
- weight of sliding hammer: 1600 g



Item #
7745

Drive Shaft Feeder Set | 12 pcs.

- for feeding of drive shafts into the wheel hub
- universally usable by rich adaptation options
- suitable for cars from: VAG, Mercedes, BMW, Porsche, Peugeot, Renault, Opel
- flange nut
- sleeve 1: OD Ø 39 mm, ID Ø 29 mm
- sleeve 2: OD Ø 46 mm, ID Ø 36 mm
- spindle M14 x 1.5 mm, external thread
- spindle M16 x 1.5 mm, inner thread
- spindle M16 x 1.5 mm, external thread
- spindle M18 x 1.5 mm, inner thread
- spindle M20 x 1.5 mm, inner thread
- spindle M22 x 1.5 mm, inner thread
- spindle M24 x 1.5 mm, inner thread
- spindle M27 x 1.5 mm, inner thread
- spindle M30 x 1.5 mm, inner thread



Item #
8262

Drive Shaft Feeder Set | 7 pcs.

- for feeding of drive shafts into the wheel hub
- based in a standardized industrial wheel bearing
- contains 6 pull bushings with different threads sizes

suitable for the following models:

- M16 x 1.5 mm: for Subaru
- M20 x 1.5 mm: for VW Beetle, Touareg - Porsche Cayenne
- M22 x 1.5 mm: for BMW E30, E46
- M24 x 1.5 mm: for BMW E36 - Mercedes W203
- M27 x 1.5 mm: for BMW E32, E34, E38, E39, X5
- M30 x 1.5 mm: for BMW E32, E34, E36



Item #
8245

Hydraulic Drive Shaft Puller | 98 - 125 mm

- hydraulic ram 12 ton
- especially for glued and rusty drive shafts
- fits on 4- and 5-hole hubs with hole circle diameter of 98 to 125 mm
- for wheel bolt size up to M14
- for big cars, SUVs and light trucks
- spindle can be turned by hand or ratchet



Item #	Description
7774	Hydraulic Drive Shaft Puller 98 - 125 mm
7774-3	Puller Feet Thread 1.1/2" x 16 mm for BGS 7774
7774-2	Washers for BGS 7774 5 pcs.
7774-1	Empty Case for BGS 7774

Wheel Hub Puller with Sliding Hammer

- allows the removal of wheel hubs
- fits on 4- and 5-hole hubs with hole circle diameters of 116 to 134 mm
- for big cars, SUVs and light trucks
- 6 kg sliding hammer, total weight 12.7 kg



Item #	Description
7772	Wheel Hub Puller with Sliding Hammer
7772-1	Sliding Hammer Adaptor
7772-2	Sliding Hammer

Wheel Hub Puller with Sliding Hammer | for Ford Transit

- suitable for removal and installation of brake discs on front and rear wheel drive on Ford Transits >2001
- sliding hammer with 6 kg weight
- external thread M24 x 2.0
- incl. impact hammer adaptor, internal thread M24 x 2.0 on internal thread M20 x 1.5
- to be used as OEM 204-345B



Item #	
7776	

Wheel Hub Puller | for Ford Transit | from BGS 7776

- suitable for removal and installation of brake discs on front and rear wheel drive vehicles
- external screw thread M24 x 2.0
- incl. sliding hammer adaptor, internal thread M24 x 2.0 of internal thread M20 x 1.5
- to be used as OEM 204-345B



Item #
7776-1

Wheel Bearing Puller | 4 & 5 hole | hole circle 100 - 115 mm | with Sliding Hammer

- suitable for flanges with 4 and 5 holes
- hole distance 100 to 115 mm
- suitable for M12 wheel bolts
- 4 kg sliding hammer
- thread 5/8" x 18
- length: 570 mm



Item #
7735

Front Hub Puller | 4 & 5 hole | hole circle 100 - 115 mm

- for flanges with 4 and 5 holes
- for wheel bolt size M12
- hole distance 100 to 115 mm

Item #
7733



Pull Adaptor | for sliding hammer

- for use with sliding hammer BGS 7719, 7735, 7745, 7733
- suitable for flanges with 4 and 5 holes
- hole distance: 100 to 115 mm
- suitable for wheel bolt size M12
- internal thread: 5/8" x 18G

Item #
7712



Sliding Hammer | for puller feet

- suitable for puller feet BGS 7712, 7733
- sliding hammer thread 5/8" 18 UNF
- adaptor thread 7/16" 14 UNF
- weight: 2.1 kg

Item #
7719



Wheel Hub Retainer Tool

- for holding the wheel hub when loosening the drive shaft, wheel bearing nut, etc.
- no pressing of the brake pedal during disassembly / assembly of the axle nut
- suitable for four and five stud wheel hubs
- length: 350 mm

Item #
9470



Pliers for Axle Boot Clamps | 235 mm

- with ear holder, prevents loosening of sleeve fasteners
- universal use, works on CV boots, fuel hoses on VAG, Opel, BMW, Mercedes-Benz, Honda, Nissan, Mazda etc.
- for working on Oetiker system ear hose clamps



Item #	
161	

Pliers for Axle Boot Clamps | for use with Torque Wrench

10 $\frac{3}{8}$ "

- forged steel
- suitable for stainless steel hose clamps
- simply adjust to the required torque using a torque wrench on the 10 mm (3/8") socket



Item #
163

Axle Boot Clamp Pliers | for VAG, Mercedes-Benz, Toyota

- suitable for progressively adjustable clamps installed on axle boots on VAG, Mercedes-Benz und Toyota
- to operate step and deaf clips
- special claws for easy application
- automatic opening



Item #	
479	

Thread Repair Kit for Drive Shafts / Prop Shafts | 8 pcs.

- for trimming and cleaning external threads
- to be turned directly on the external hexagon without die holder
- color coding metric / inch
- tap M24 x 1.50 mm - 13/16" x 20 UNEF
- tap M24 x 2.00 mm - 3/4" x 20 UNEF
- tap M22 x 1.00 mm
- tap M22 x 1.50 mm
- tap M20 x 1.50 mm
- tap M20 x 1.25 mm



Item #	Description
1141	Thread Repair Kit for Drive Shafts / Prop Shafts 8 pcs.
1141-LEER	Empty Case for BGS 1141

Propshaft Separator

- for removing the constant-velocity joints on the front drive shafts
- fits for most car models (except for Seat)
- extra wide frame for large joints
- non-slip and adjustable grip jaws
- internal tool width: 99 mm
- internal tool length: 204 mm

Item #
1518

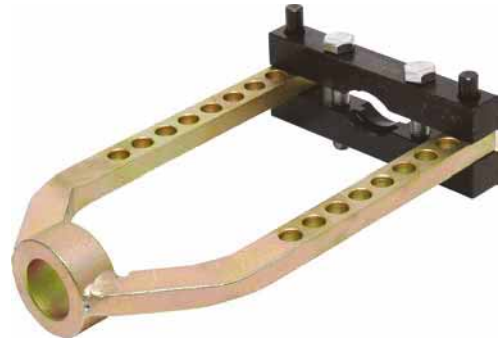

Drive Shaft Removing Tool | for BMW 4WD vehicles

- for removing the drive shaft from the front axle
- suitable for 4WD BMW 535IX, X3 and X5
- makes disassembly much easier
- dip insulated handles

Item #
8292



Drive Shaft Socket | for VAG 4WD

20 **3/4**

- for loosening and tightening the drive shaft nut on the drive shaft
- suitable for drive shaft nuts on 6-speed gearbox 0A3 (4WD)
- to be used as OEM T40097
- to be used on e. g.: Audi A4 2001+, Audi A6 2005+

Item #
8572



Axle Tolerance Testing Tool

12.5 **1/2**

- for locating defects on axles, such as defective ball joints, wheel bearings, etc.
- suitable for fault diagnosis with loaded axle (as in normal operation)
- testing is carried out through visual, acoustical and tactile sense verification
- especially suitable when car is mounted on 4-post lift but also usable on the workshop floor
- with 12.5 (1/2") drive for use with sliding bar
- total length: 355 mm
- dimensions of the plastic coating: Ø 60 x length 265 mm

Item #
8633



Axle Boot Clamp Set | 12 pcs.

- for securing of rubber axle boots on drive shafts
- zinc coated
- can be mounted e. g. with Pliers for Axle Boot Clamps (BGS 161)
- length: 430 mm
- BGS 9451, width: 7 mm
- BGS 9452, width: 9 mm



Item #	Description
9451	Axle Boot Clamp Set 7 mm 12 pcs.
9452	Axle Boot Clamp Set 9 mm 12 pcs.

Universal Axle Boot Set | 4 pcs.

- suitable as a replacement for many axle boots
- allows a cost- and time-saving repair
- 3 steps, joint side diameter approx. 80, 90 and 100 mm (unstretched)
- with inside holding nose on all three steps
- diameter of shaft side approx. 30 mm
- length: approx. 128 mm
- extremely elastic and durable material
- especially suitable for use with BGS 162 boot slider
- includes lubricating grease for all types of drive shaft joints
- multistep boot clips



Item #
164

Wishbone Lever Tool

- to depress the wishbone and other axle parts when removing the drive shaft, when changing the drive shaft boot or the wheel bearing
- facilitates the removal of control arm ball joints from the wheel bearing housing
- also very helpful in the assembly of pre-tensioned control arms
- support adjustable in 3 positions
- neoprene handle for secure grip
- length: approx. 120 cm



Item #
3521

Wishbone Lever Tool | with Chain

- enables convenient lowering of the wishbone
- holds the wishbone in the retracted position
- required for example when replacing the wheel bearing, repair on the strut or the drive shaft
- no risk of injury due to sliding mounting lever
- prevents damage to the ball joints and drive shaft sleeves
- for easy and fast assembly
- low height
- universal use due to adjustable chain
- support surface with anti-slip support
- maximum traction: 500 kg
- total length incl. hook: 1030 mm
- Clamping height: 65 mm to 265 mm
- chain length including hook: approx. 660 mm



Item #
9414

Spring Strut Set | 8 pcs.

12.5  1/2

- contains essential tools for upper piston rod nuts on the shock absorber and for spreading the strut clamp in the pivot bearing
- includes the following spreader sockets:
 - 5.0 mm spreader, 60 mm long, 12.5 mm (1/2") drive
 - 5.5 mm spreader, 48 mm long, 12.5 mm (1/2") drive
- the following special sockets for upper shock absorber nuts:
 - internal Ø 10.5 mm, 3.5 mm pin, 22 mm 6-pt. drive
 - internal Ø 12.5 mm, 3.5 mm pin, 22 mm 6-pt. drive
 - internal Ø 14.5 mm, 5.0 mm pin, 22 mm 6-pt. drive
 - internal Ø 14.0 mm, 2.5 mm mm pin, 22 mm 6-pt. drive
 - internal Ø 15.0 mm, 5.0 mm pin, 22 mm 6-pt. drive
 - internal Ø 12.5 mm x external 15.5 mm, 3 mm pin



Item #
6457



Shock Absorber Tool Kit | 39 pcs.

- for counterholding the piston rod while loosening
- hexagon sockets, long, for loosening 14 - 16 - 17 - 18 - 19 - 21 - 22 - 24 - 27 mm
- 2-tap sockets for loosening: 10.5 - 12.5 - 14.0 - 14.5 mm
- 2-pin locknut inserts for loosening: 10.5x3.5 mm, for Volkswagen
- 2-pin locknut inserts for loosening: 12.5x3.5 mm, for Volkswagen
- 2-pin locknut inserts for loosening: 14.0x2.5 mm, for Mercedes-Benz
- 2-pin locknut inserts for loosening: 14.5x3 mm, for VAG
- 2-pin locknut inserts for loosening: 14.5x5 mm, for Austin
- slot-profile socket for counterholding: 4 - 5.2 - 6 - 6.3 - 7 - 8 - 9 - 10 - 12 mm
- D-profile bits for counterholding: 5 - 10 mm
- hexagon sockets for counterholding: 8 - 9 - 10 - 11 mm
- hexagon bits for counterholding: 5 - 6 - 7 - 8 mm
- slotted bits for counterholding: 3 - 3.5 - 4 mm
- spline bit M12
- T-star (for Torx) bits for counterholding: T50 - T60



Item #	Description
2086	Shock Absorber Tool Kit 39 pcs.
2086-H5	Special counterholding Bit internal Hexagon 5 mm
2086-H6	Special counterholding Bit internal Hexagon 6 mm

Shock Absorber Tool Kit | 18 pcs.

12.5  1/2

- fits most popular vehicle types
- for repair jobs on shock absorbers and for counter holding the shock absorber piston
- 1 push-through reversible ratchet, 12-point 21 mm
- 7 sockets, hexagon, deep, 12.5 mm (1/2") and external hexagon 21 mm, 16 - 17 - 18 - 19 - 21 - 22 - 24 mm
- 3 bit sockets, length 122 mm, 12.5 mm (1/2"), internal hexagon 6 - 7 - 8 mm
- 3 bit sockets, length 122 mm, 12.5 mm (1/2"), special profile (oval), 5x8 - 6x8 - 7.1x9.6 mm, suitable for Porsche Cayenne S, VW Touareg
- 1 bit socket, length 122 mm, 12.5 mm (1/2"), T-star (for Torx) T50, suitable for Opel Astra H
- 1 socket, hexagon, deep, 12.5 mm (1/2"), length 122 mm, 7 mm, suitable for Mercedes Benz Vaneo
- 1 socket, hexagon, deep, 12.5 mm (1/2"), length 122 mm, 8 mm, suitable for BMW
- 1 socket, hexagon, deep, 12.5 mm (1/2"), length 122 mm, 9 mm, suitable for Opel Corsa B, Astra F/G, Vectra B



Item #
2087



Shock Absorber Tool Kit | 21 pcs.

- for loosening of shock absorber nuts
- suitable for most vehicles, incl. Japanese gas shock absorbers
- extension socket
- rotating plate with 39 / 34 mm external hexagon
- rotating plate with 60 mm internal hexagon
- 90° rotation plate, universal
- 120° rotation plate for Japanese cars
- 4 holding plates each with 4-pt. head and round head
- 4 screws M6 x 18
- 4 mm internal hexagon wrench
- 3 sockets for grooved nuts with 22 mm hexagon drive in following sizes:
 - 10.5 mm inner diameter with 3.5 mm pin
 - 12.5 mm inner diameter with 3.5 mm pin
 - 14.5 mm inner diameter with 3.5 mm pin



Item #
8679

Shock Absorber Tool Kit | for Shock Absorbers with Stop Spring | 8 pcs.

- allows an easy mounting and dismounting of shock absorbers with tension stop springs
- the tension stop spring prevents a complete pull-out of the piston rod and makes it difficult to assemble the spring plate (camber plates)
- the tool allows a complete pulling out of the piston rod against the tension stop spring
- fits on most shock absorbers with tension stop springs, on e.g. BMW / MB / Toyota / Nissan / Fiat / Peugeot / Ford, etc.

scope of delivery:

- universal clamping piece with plastic jaw protector
- 2 clamping screws set, short
- intermediate bearing with telescopic pipe receiving thread
- telescopic basic unit with handle
- 1 knob
- T-handle hex. wrench with ball head



Item #
8877

Spreader Sockets for Spring Strut Clamps

12.5 mm 1/2"

- for damage-free spreading of the strut clamps on VAG, BMW, Citroen, Ford, Renault, Japanese cars etc. wheel bearing housings



Item #	Description
6453	Spreader Socket for Spring Strut Clamps 12.5 mm (1/2") Drive 5.5 x 8.2 mm
6454	Spreader Socket for Spring Strut Clamps 12.5 mm (1/2") Drive 5 x 7 mm
6455	Spreader Socket Set for Spring Strut Clamps 12.5 mm (1/2") Drive 5 x 7 mm + 5.5 x 8.2 mm 2 pcs.



Spring Strut Set | 4 pcs.

- for VAG and Mercedes-Benz shock absorber bolts
- 22 mm hexagon drive
- inside Ø 10.5 mm, 3.5 mm pins
- inside Ø 12.5 mm, 3.5 mm pins
- inside Ø 14.0 mm, 2.5 mm pins
- inside Ø 14.5 mm, 5 mm pins



Item #	
1111	

Spring Strut | for VW, Audi | 22 mm Drive

- surface finish: black burnished



Item #	
155	

Shock Absorber Counter holding Wrench | for Shock Absorbers with Oval Pins

- ideal for countering during assembly and disassembly of the rear shock absorber piston rods
- universally usable for all common types of shock absorbers with oval pins
- two different wrench sizes: 5 x 8 mm and 6 x 9 mm
- safer and easier to use than locking pliers
- wrench ends slightly angled, for more loosening space
- length: 182 mm
- surface finish: chrome plated



Item #	
1301	

Shock Absorber Wrench | for Shock Absorber Screwing on Mercedes-Benz

- for loosening the upper shock absorber screwing
- the recess in the front part of the pin wrench allows counterholding of the piston rod
- plastic coated shaft prevents damage to the car painting
- suitable for Mercedes-Benz 211T-Model rear axle (E-Class station wagon)
- for nuts with 3-pin adaptor
- length: 230 mm



Item #	
8307	

Bench Vice Clamping Tool | for Struts

- for clamping MC Pherson struts in bench vices
- facilitates working on spring and shock absorbers
- protective rubber jaws prevent damage to the strut
- suitable for fixed mounting on the workbench
- material: carbon steel (S45)
- surface finish: phosphated



Item #
3150

Spring Compressor Set | 2500 kg

- professional spring compressor for daily workshop use
- for springs with a diameter of 90 to 140 mm
- especially suitable for vehicles with small hole in the spring control arm, down to \varnothing 30 mm e.g. VW Touran, Citroen C3, Skoda Octavia, Peugeot 107
- suitable for double wishbone / multi-link suspension systems
- good fit of the spring due to angled jaws, which increases the safety and functionality
- special socket prevents overloading of the spring compressor
- maximum load: 25000 Nm
- minimum distance: 96 mm
- maximum distance: 220 mm
- maximum spring travel: 124 mm
- 2 tensioning jaws 90 to 120 mm
- 2 tensioning jaws 120 to 140 mm
- special spindle for limited spaces \varnothing 30 mm
- special socket for torque limit



Item #
985

Spring Compressor Set | 1800 kg

- for safe disassembling / assembling of cylindrical spiral springs
- can be clamped in a vice, safe for one-man operation
- max. capacity: 1800 kg
- compressor body: length 500 mm, 5.4 kg
- additional jaws available under BGS 1134-XX
- 1 body
- 2 spring retainers \varnothing 80 - 145 mm
- 2 spring retainers \varnothing 145 - 195 mm
- max. capacity: 18000 N
- clamping depth: 65 - 364 mm



Item #
1144



Spring Compressor Set | 1500 kg

- for safe disassembling / assembling of conical, cylindrical & spherical springs out of McPherson struts
- maximum capacity: 1,500 kg (15,000 N)
- min. clamping depth: 65 mm
- max. clamping depth: 354 mm
- compressor body length: 475 mm
- compressor body weight: 4.7 kg
- weight incl. spring retainers: 10.2 kg
- 1 body
- 2 spring retainers Ø 80 - 145 mm
- 2 spring retainers Ø 145 - 195 mm



Item #	Description
1134	Spring Compressor Set 1500 kg
1134-1	Safety Wire for Spring Compressor products 1134, 1144
1134-10	Spring Support for BGS 1134, 1144 Ø 80 - 145 mm
1134-100	Spring Support Set for BGS 1134, 1144 for Peugeot Break, Citroen C15
1134-108	Spring Support "Plus" for BGS 1134, 1144 with protective insert Ø 80 - 120 mm
1134-110	Spring Support "Plus" for BGS 1134, 1144 with protective insert Ø 80 - 200 mm
1134-20	Spring Support for BGS 1134, 1144 Ø 145 - 195 mm
1134-25	Jaw for left twisted springs for BGS 1134, 1144
1134-30	Spring Support for BGS 1134, 1144 Ø 140 - 170 mm
1134-50	Spring Support for BGS 1134, 1144 Ø 80 - 120 mm
1134-60	Spring Support for BGS 1134, 1144 Ø 80 - 145 mm
1134-70	Jaw for BMW E39/E46 / Renault Megane II for BGS 1134, 1144
1134-75	Jaw for BMW Series 1/2/3/4 Mini One/Cooper/Cooper S for BGS 1134, 1144
1134-80	Jaw for Mercedes-Benz C-Class W203 until YOM 2008 for BGS 1134, 1144
1134-85	Jaw for Mercedes-Benz C-Class W204 / 205 as of 2008 for BGS 1134, 1144
1134-90	Jaw for Mercedes E-Klasse for BGS 1134, 1144
1134-95	Jaw for Renault Twingo 2014 for BGS 1134, 1144



Ball Joint Set | 7 pcs.

- allows disassembly of ball joints in various sizes
- suitable for cars, light trucks and SUVs
- 5 interchangeable forks 20 - 22 - 24 - 27 and 30 mm
- maximum pressure range: 125 mm
- heavy version

Item #
1790

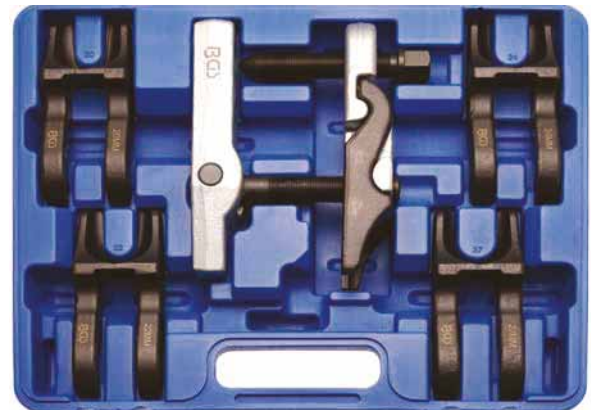

Ball Joint Shifter Set | 23 - 28 - 34 mm | 3 pcs.

- for ejecting the ball joint out of axle legs, drop arms, stabilisers
- ejectors are universally usable, fit e. g. Mercedes-Benz, VAG and Opel
- especially for working in narrow spaces
- suitable only for working on closed joints or joints with centre hole
- sizes: 23x55, 28x55, 34x63 mm

Item #	Description
1813	Ball Joint Ejector Set 23 - 28 - 34 mm 3 pcs.
1813-23	Ball Joint Ejector opening 23 mm
1813-28	Ball Joint Ejector opening 28 mm
1813-34	Ball Joint Ejector opening 34 mm



Fork Type Separator Set | 5 pcs.

- forged execution separator
- fork type, length 300 mm, fork opening 23 mm
- fork type, length 300 mm, fork opening 26,5 mm
- fork typer, length 300 mm, fork opening 36 mm
- fork type, length 300 mm, fork opening 40 mm
- fork type, length 400 mm, fork opening 17 mm

Item #
63800

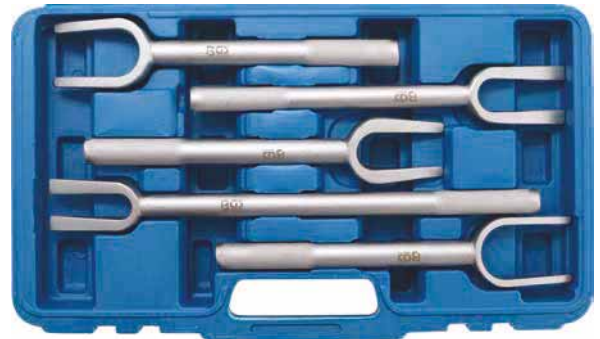

Fork Type Separator Set | 5 pcs.

- with interchangeable fork heads
- for quick release of tie rod ends, steering levers, etc.
- fork openings approx. 17.4 - 23.8 - 28.5 mm
- manufactured from forged carbon steel
- handle for manual use
- adaptor for air hammer use (10 mm shaft)

Item #
1806

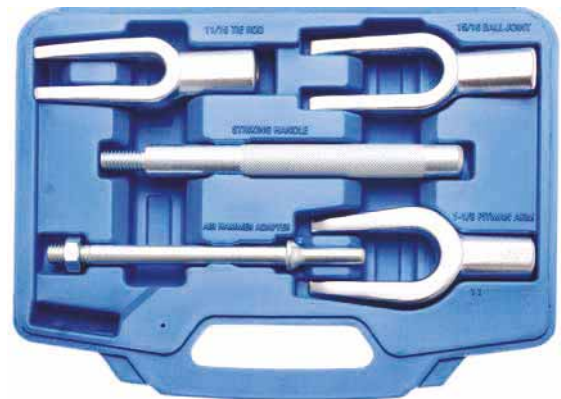

Ball Joint Fork Separator Set | for Air Hammer | 5 pcs.

- for separating ball joints
- includes 5 fork separators: fork opening: 20 - 24 - 30 - 35 - 42 mm
- suitable for air hammer kit e. g. BGS 3515
- high loosening power due to vibration
- shaft diameter 10 mm
- length: 180 mm



Item #
8894

Supporting Joint Tool Set | VW T4

- for assembly and disassembly of the upper suspension joints / guide joints on VW T4 Bus, Multivan, California, etc.
- suitable for: VW T4 front axle
- 1 extractor with hardened spindle, drive: external hexagon 24 mm, opening width 55 mm, inside height 70 mm
- 2 pressure piece adapters for pressing out
- 1 pressure piece adapter for pressing in
- 2 extension plates to adapt the extractor to the joint



Item #
8231

Supporting Joint Tool Set | for Mercedes-Benz

- allows dismantling and mounting of supporting joints
- suitable for Mercedes Benz W211 (E-class) / W220 (S-class) / W230 (SL-class) series
- heavy duty type
- pressure spindle 190 mm with 24 mm drive
- C-clamp with max. 155 mm opening
- 2 compression heads 40 mm and 54 mm
- 3 pressure pieces 22 mm, 33 mm and 57 mm



Item #
8293

Stabiliser Ball Joint Tool | for Supporting Joint Tool Set | for BGS 8293

- this extension tool allows a disassembly and assembly of the ball joints, suitable for Mercedes Benz W211 (E-class) / W220 (S-class) / W230 (SL-class) series
- to be used as OEM 2113230068
- material: S45C steel
- to be used with BGS 8293



Item #
8293-1



Supporting Joint Tool Set | for Volvo

- especially designed for dismounting and mounting of supporting joints in lower control arms (wishbones)
- suitable for following models with control arms made of aluminum and steel: Volvo S60 (2000-2009), V70 (1999-2007), XC70 (1999-2007), S80 (1998-2006), XC90 (2002-2014)
- to be used as OEM 9995796

scope of delivery:

- 1 press tool
- 2 guide bolts
- 3 ball joint adaptors M12x1.75 - M14x1.5 - M14x2.0
- to be used with e.g. the following BGS sliding hammers:
sliding hammer BGS 7772 + adaptor BGS 7772-4
sliding hammer BGS 7719 + adaptor BGS 7719-1



Item #
9420

Supporting Joint Tool Set | for BMW 3-series

- for installing / removing the supporting joints on BMW E36 series
- can also be used for hydro and plastic bushes

scope of delivery:

- disassembly counter holding sleeve, for resting in the opening of the base plate, outer diameter 49.0 mm, inner diameter 40.3 mm
- disassembly pressure sleeve, 68.2 mm outer diameter, 50.7 mm high, 2 opposite recesses 39.8 mm wide, 39.7 mm high
- mounting pressure sleeve, 62.3 mm outside diameter, 35.3 mm high, 2 opposite recesses 34.8 mm wide, 18.3 mm high
- sleeve, 47.5 mm high, 39.7 mm inside diameter, 49.1 mm outside diameter, 35.1 mm inside height, center thread M12 x 1.75 mm



Item #
8482

Ball Joint Puller | for Mercedes-Benz

- for removal and installation of lower ball joints on the wishbone
- suitable for Mercedes Benz models W124, W129, W201
- consisting of pressure frame, disassembly and assembly pressure piece and reducer ring
- allows a much easier renewing of ball joints
- spindle with hexagon drive



Item #
8781

Ball Joint Spreader Tool Set | 7 pcs.

- for spreading the seats of shock absorbers and steering parts
- with 2 exchangeable spreading inserts (5 mm and 8 mm depth) and guide pins 8x10 mm (2x) and 10x12 mm (2x) for the shock absorber seat in the wheel bearing housing when changing the damper, for wishbone ball joint seat when disassembling the suspension strut etc.
- slipping off is avoided by strong guiding bolts that are stuck in the screw holes
- a spindle with 13 mm external hexagon pushes the spreader in the opening, no need to use a hammer
- material fatigue and breakage esp. of aluminium parts is avoided

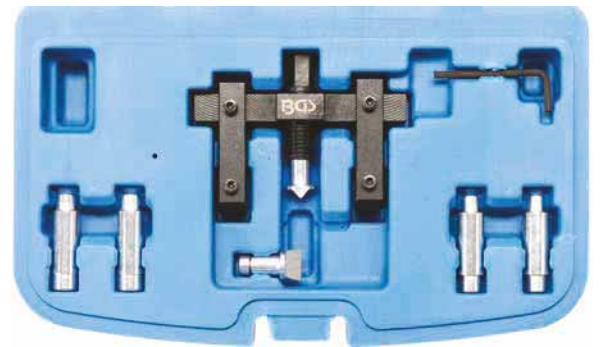

Item #
65592

Ball Joint Separator

- forged carbon steel

BGS 1796

- pulling width: 46 mm
- pulling height: 47 mm
- overall width: 70 mm
- spindle M16 x 1.5 / hexagon 17 mm
- width: 70 mm

BGS 1797

- pulling width: 62 mm
- pulling height: 64 mm
- overall width: 85 mm
- spindle M18 x 1.5 / hexagon 19 mm
- width: 85 mm



Item #	Description
1796	Ball Joint Separator 23 mm
1797	Ball Joint Separator 29 mm

Tie Rod Separator | 18 mm

- forged
- surface finish: galvanised

Item #
1803



Ball Joint Separator | 19 mm

- suitable for many vehicles
- forged
- fork opening: 19 mm
- max. clamping width: 50 mm

Item #
1807



Ball Joint Separator | 20 mm

- universally applicable
- for all vehicle types for removing bearings for separating the ball plug when removing the ball joints
- fork opening: 20 mm
- max. clamping width: 50 mm

Item #
1804



Ball Joint Separator | 20-22 mm

- forged
- clamping range in 2 positions adjustable: up to 30 and 55 mm
- for extracting the ball joints on tie rods and stabilizers
- surface finish: satin chrome plated
- fork opening: 20 - 22 mm

Item #	Description
1795	Ball Joint Separator 20-22 mm
1795-1	Replacement Spindle for Ball Joint Separator



Ball Joint Separator | 21 mm

- universally applicable
- adjustable in 2 steps
- can be used in passenger cars and vans
- heavy design
- for use with 17 mm hexagon socket
- weight: 1.56 kg
- fork opening: 21 mm
- max. clamping width: 80 mm
- min. clamping width: 50 mm



Item #
8410

Ball Joint Separator | 30 mm

- universally applicable
- heavy duty finish with milled jaws
- spindle with ball tip
- for removal of ball joints on cars, SUV and vans
- suitable for operation with impact wrenches
- for use with 22 mm hexagon socket
- length: 190 mm
- width: 150 mm
- height: 43 mm
- weight: 2.9 kg
- fork opening: 30 mm
- max. clamping width: 52 mm



Item #
8411



Ball Joint Separator | hydraulic | 8 t

- gives you a higher separating pressure, especially under narrow space conditions
- fork width 23 mm
- max. clamping width: 56 mm



Item #
8528

Injection Pump Wheel Puller | adjustable opening | 20 - 30 mm

- for removal of e.g. suspension ball joints, tie rod joints, etc.
- this tool is made from special chrome molybdenum / S45C steel for max. torque
- adjustable pressure range up to 70 mm
- surface finish: chrome plated
- fork opening: 20 - 30 mm



Item #
8541

Fork and Mount Type Separators

- manufactured from hardened carbon steel
- zinc coated
- for a quick and secure separation of tie rod ends, pitman arms etc.



Item #	Description
1809	Fork and Mount Type Separator 200 mm Jaw 18 mm
1805	Fork and Mount Type Separator 410 mm Jaw 18 mm
1808	Fork and Mount Type Separator 295 mm Jaw 23 mm



Fork and Mount Type Separator | adjustable | 18 - 42 mm

- knurled and black finish handle, satin chrome plated fork
- opening width: 18 - 42 mm
- for separating ball joints, tie rods etc.
- surface finish: satin chrome plated



Item #	CV 
65550	

Supporting Joint Pin Wrench | for Mercedes-Benz M-Class

20  3/4

- for Mercedes Benz M-class W163 until June 2005 and W164 as of 2005
- for professional changing of the front and rear axle suspension ball joints
- facilitates loosening and tightening counter-nuts of the suspension joints with correct torque
- suitable for the lower suspension joints on front - and rear axle
- 3/4" drive



Item #
5420

Pin Wrench for Suspension Joints | for Citroen / Peugeot

12.5  1/2

- for loosening / tightening of suspension joints
- suitable for models: Citroen BX (9/1982 - 1994), C5, Xantia / Peugeot 305 (7/1982 - 1990), 405 (6/1987), 406, 605, 607 etc.



Item #
5422



Pin Joints Socket | for Mercedes-Benz M-Class

12.5  1/2

- suitable for suspension ball joints on front and rear axles on Mercedes-Benz M-Class W163 and W164
- especially short type



Item #
8575



Ball Joint Tool | for Audi

12.5  1/2

- for loosening tightly fitted ball joints
- turning of ball joint with this tool facilitates dismounting
- suitable for Audi A4, A5, A6, A7, Q5
- 27 mm hexagon with guide bore
- 12.5 mm (1/2") drive



Item #
9031



Ball Joint Puller for Impact Wrench | Ø 39 mm

- suitable for cars, light trucks and SUV
- solid execution for long product life time
- hardened pressure spindle and centering tip
- suitable for impact wrenches

BGS 67216

- opening on the support fork: 23 mm
- opening on the puller housing: 56 mm
- max. pressure range: 59 mm
- 19 mm drive

BGS 67213

- opening on the support fork: 30 mm
- opening on the puller housing: 59 mm
- max. pressure range: 59 mm
- 19 mm drive

BGS 67214

- opening on the support fork: 32 mm
- opening on the puller housing: 70 mm
- max. pressure range: 92 mm
- 26 mm drive

BGS 67215

- opening on the support fork: 39 mm
- opening on the puller housing: 80 mm
- max. pressure range: 94 mm
- 26 mm drive

BGS 67218

- opening on the support fork: 62 mm
- opening on the puller housing: 100 mm
- max. pressure range: 118 mm
- 20 mm (3/4") drive



Gearbox / Axle / Steering

Item #	Description
67216	Ball Joint Puller for Impact Wrench Ø 23 mm
67213	Ball Joint Puller for Impact Wrench Ø 30 mm
67214	Ball Joint Puller for Impact Wrench Ø 32 mm
67215	Ball Joint Puller for Impact Wrench Ø 39 mm
67218	Ball Joint Puller for Impact Wrench Ø 62 mm

Clutch Aligning Tool Set

- universal application for vehicles with a hub diameter of Ø 15.0 - 26.0 mm
- for mounting single and double disc dry clutches
- for centering of clutch discs on cars with and without pilot bearings
- suitable for cars, SUV and small trucks with front, rear and 4-wheel drive
- spindle guide: 55 mm long, M15 x 1.5, mandrel range: 15 mm to 19 mm
- spindle guide: 100 mm long, M15 x 1.5, mandrel range: 19.5 mm to 26 mm
- spindle guide: 150 mm long, M15 x 1.5 thread for small and large cones
- small cone adaptor, spindle inner thread: M15 x 1.5, range: 19 - 30 mm, inner diameter: 20 mm, suitable for 55 mm spindle guide
- large cone adaptor, spindle inner thread: M15 x 1.5, range: 26 - 35 mm, inner diameter: 27 mm, suitable for 100 mm spindle guide
- dual disc adaptor height: 30 mm, cone side: 29 - 49 mm, plate side: 49 - 69 mm, for clutches without pilot bearing
- pilot adaptor Ø 10 - 12 - 14 - 15 - 16 - 17 - 19 - 25 - 27 mm, for clutches with pilot bearing

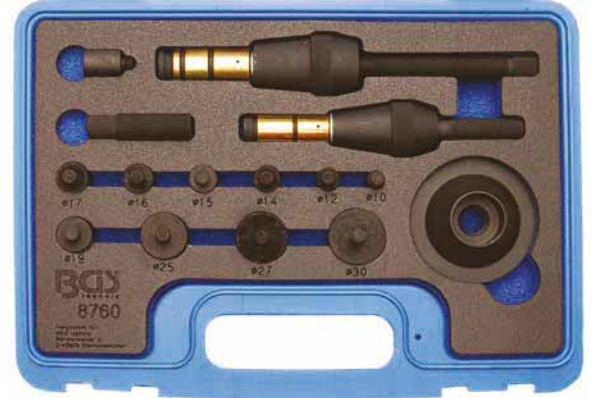

Item #
8760

Clutch Aligning Tool Set

- for clutch discs with 15 to 28 mm clutch hub diameter
- allows an accurate centering of the clutch disc on vehicles with or without pilot bearing
- alignment according to friction surface of the clutch pressure plate
- suitable for most vehicles
- centering sleeve Ø: 12, 14, 15, 16, 17, 18 & 19 mm



Item #
1708

Clutch Aligning Set | 2 pcs.

- universal use for vehicles with a hub diameter of Ø 15.0 mm - 26.6 mm
- for mounting single-disc dry clutches
- centering the clutch disc over the guide bearing is not necessary
- in 2 sizes: 15 - 19 mm and 20 - 26.6 mm



Item #
1709

Clutch Aligning Tool Set | 17 pcs.

- 8 conical centering bushes for clutch discs with hole sizes: 14.5 - 25.5 mm
- 8 adaptors for centering in the crankshaft: 10.8 - 12.2 - 13.5 - 14.7 - 15.8 - 17.1 - 18.3 - 19.9 mm
- centering shaft 145 mm



Item #
1712

Clutch Aligning Tool

- for centering the clutch disc in cars without clutch pilot bearing
- universal use with a hub diameter of 15.0 - 28.0 mm
- continuously adjustable in diameter from 15.0 - 21.0 / 17.0 - 25.0 / 22.0 - 28.0 mm

scope of delivery:

- 1 centering tool with clamping cone
- 2 clamping cones 15.0 - 21.0 / 17.0 - 25.0 mm



Item #
1710



SAC Clutch Tool Set | 38 pcs.

- for fast and professional disassembly and assembly of SAC clutches
- fits on nearly all SAC clutches with 3- and 4-hole pitch from the following models: VAG, MB, Opel, Volvo, Renault etc.
- as e.g. on models:
 - Audi A3, A4, A6, A8
 - VW Passat, Golf, Sharan, Tiguan
 - Ford Mondeo, S-Max, Galaxy, Transit
 - Mercedes-Benz C, E, CLS, S, CLK, SLK, SL
 - BMW 320, 330, 520, 530
 - Alfa Romeo 147, 159, 166
 - Fiat Ulysse, Croma, Ducato
 - Lancia Phedra, Thesis
- 7 coupling aligning mandrels, 12, 14, 15, 16, 17, 18, 19 mm
- 1 pressure spindle
- 1 reset tool
- 1 4-arm traverse
- 1 3-arm traverse
- 1 handle
- 4 securing bolts M6
- 4 securing bolts M7
- 4 securing bolts M8
- 4 nuts for securing bolts M8
- 1 centre punch bore
- 1 centering tool spindle with cone
- 1 basic centering tool clamping nut
- 1 basic centering tool shaft sleeve
- 2 clamping cones
- 4 coupling aligning mandrels 23, 26, 28, 34 mm



Item #
8286

Duplex Clutch Repair Kit | for VAG DSG Transmission

- required for repair of the clutch unit

suitable for following models:

- VW Golf (2004), Golf Plus (2005) with 7 speed gearbox (Code 0AM)
- Audi A3 (2004) with 7 speed gearbox (Code 0AM)
- support bridge to be used as OEM T10323
- puller to be used as OEM T10373
- gange block to be used as OEM T10374
- pressure piece to be used as OEM T10376



Item #
8320

Dual Clutch Tool | for Volvo, Ford, Chrysler, Dodge

- for removing and installing dual clutches
- suitable for Getrag 6-speed dual clutch transmission with code 6DCT450 / MPS6

suitable for following models:

- Volvo C30, C70 (2006), C40 (2004), S60 (2011), S80 (2007), S80L, V40 (2013), V40 Cross Country, V50, V60, V70 (2008), XC60
- Ford Focus (2004), C-Max, S-Max, Galaxy, Mondeo (2007), Kuga
- Chrysler Sebring
- Dodge Avenger, Journey

- to be used as OEM Volvo 9997435 / Ford 308-763



Item #
9023

Reset Tool | for BMW SAC Clutch

- required for the professional assembly and disassembly of SAC clutches

suitable for following models:

- E34, E36, E38, E39, E46, E52, E53, E60, E61, E81, E83, E85, E86, E87, E88, E90 and E91
- can be used in conjunction with BGS 8284
- easy handling, saves time and trouble
- stop screw and adjusting lever, knurled
- to be used as OEM 212180



Item #
8283

Pre-Tensioning Tool | for BMW SAC Clutch

- required for the tension-free assembly and disassembly of SAC clutches
- prevents plate distortion can happen without using a special tool
- suitable for series: E34, E36, E38, E39, E46, E52, E53, E60, E61, E81, E83, E85, E86, E87, E88, E90 and E91
- the resetting of the adjusting ring is possible in conjunction with BGS 8283
- easy handling, saves time and trouble
- knurled locking screw and adjusting lever
- ball bearing mounted pressure piece, to be used as OEM 212170



Item #
8284

Testing Tool for Dual-Mass Flywheel

- suitable for testing of freeplay angle and the clearance on dual mass flywheels (DMF), a checking of the flywheel is recommend because a worn or defective DMF can damage the new clutch
- test can be performed directly on the vehicles if the clutch has been removed
- 2 different claws for locking the flywheel
- rotary angle disc with holder
- dial indicator with holder
- assembly / measuring bolt
- twist lever



Item #
8681

Release Shaft / Bolt Puller

suitable for the following work:

- extracting the clutch release shaft on Fiat Ducato (1994) with pulling clutch
- extracting the chain guide rail bolt on BMW and Mercedes engines
- includes puller body with M8 x 1.25 internal spindle thread
- pull clamp for clutch release shaft
- M6 x 1.0 (M8 x 1.25) bolts for removing the guide rail bolt



Item #
8520

Piston Rod Removing Pliers | for Clutch Master Cylinder

- for quick and easy release of the clutch master piston rod from the clutch pedal
- very useful tool when removing the clutch master cylinder, clutch pedal, pedal support bracket, etc.

suitable for following modells:

- Opel Astra-J, Signum, Vectra-C
- Audi A1 (8X), A3 (8P), A4 (B7), A6 (C6)
- VW Golf (1K1), Passat (3B6), Eos (1F)



Item #
8968



Dual Clutch Tool | for BMW DSG transmission

- for rotating the clutch case
- required when removing or installing the clutch case
- suitable for BMW DKG transmission (GS7D36SG), built in 2008-14 M3, 135i, 335is, M5 (F10), M6 (F12 / F13)
- to be used as OEM 230400



Item #
9276

Brake Band Piston (B1) Assembly Tool Set for Mercedes Automatic Transmission 722.x

- for installing of brake band piston B1
- suitable for automatic transmission: 720.1 / 722.0 / 722.1 / 722.3 / 722.4 / 722.5
- to be used as OEM 201589035900



Item #
9323

Setting Gauge (K1&K2) | for VAG DSG Gearboxes as of 06/2011

- for adjusting the clutch K1 & K2 on VAG DSG transmission as of 06.2011
- supplementary tool for VAG DSG transmission duplex clutch repair kit (BGS 8320)
- to be used as OEM T10466



Item #
9339

Steering Gear Tool Set

- allows easy mounting of rubber bearings and bushings
- suitable for most cars, SUV, Pick Ups, etc.
- 10t hydraulic cylinder
- 2 pressure pieces, length: 28 mm and 95 mm
- 4 pulling spindles, M10x1.5 - M12x1.75 - M14x2.0 - M16x2.0
- 22 assembly bushes, length 40 mm
- 22 assembly bushes, length 110 mm, bush dimensions (external Ø x internal Ø): 26x18, 28x20, 30x22, 32x24, 34x26, 36x28, 38x30, 40x32, 42x34, 44x36, 46x38, 48x40, 50x42, 52x44, 54x46, 56x48, 58x50, 60x52, 62x54, 64x56, 66x58 und 68x60 mm



Item #
8683

Camber Adjusting Tool

- allows one-person adjusting
- reduces the required time
- clamping width: 135 - 175 mm
- 22 mm hexagon spindle
- 3 spindle lengths for a wide range of applications
 - 75 mm for e. g. Seat Toledo VW Jetta, Golf
 - 85 mm for e. g. Seat Cordoba VW Polo from 1995
 - 115 mm for e.g. Chrysler Voyager

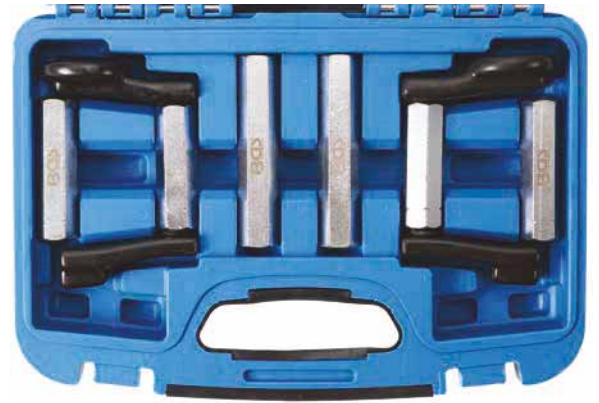

Item #
8700

Track Rod Setting Set

- changing of the tie rod ends is possible without additional alignment
- reduces the workload when changing tie rods
- main unit with clamping device
- 10 and 12 mm caliper, short and long type
- 17 mm calliper for VW
- fixing unit
- caliper for depth measuring

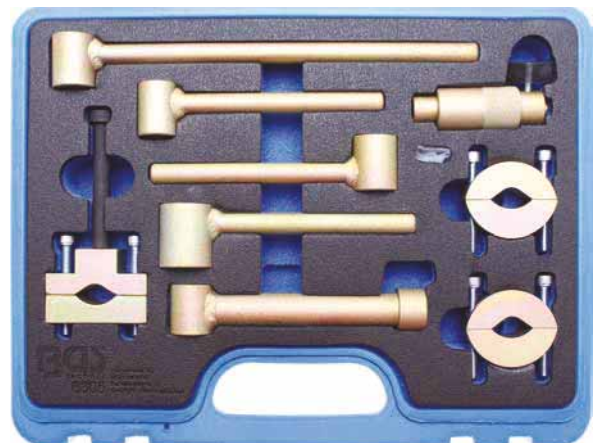

Item #
8305

Camber Setting Tool | for BMW

- allows the adjustment of ambers on the following BMW Models: E38, E39, E46, E53, E60, E61, E63, E64, E65, E66, E67, E81, E83, E85, E86, E87, E90, E91, E92, E93
- tool remains on the spring strut until all screws are tightened, therefore no recalibration required
- made of aluminium



Item #
66151

Tie Rod Wrench | 12.5 mm (1/2 ") Drive | 25 - 55 mm

12.5 1/2

- for renewing round and hexagon tie rods
- suitable for many European, Asian and American vans, SUVs and larger cars
- toothed clamping element prevents slipping
- also suitable for stuck tie rods



Item #	
66535	

Tie Rod Wrench | 12.5 mm (1/2") Drive | 27 - 42 mm

12.5 1/2

- for replacing tie rods
- suitable for inner tie rod end diameters from 27 to 42 mm
- for loosening and tightening
- made of high-strength chrome-molybdenum steel
- allows high torque transmission



Item #	
8796	

Tie Rod Wrench | 12.5 mm (1/2 ") Drive | 32 - 42 mm

12.5 1/2

- for loosening and tightening tie rods
- the tool is attached to the axial joint and fixes itself when loosening or tightening via eccentrically mounted toothed rollers
- small dimensions for tight spaces
- suitable for axial joint diameter 32-42 mm



Item #
66534

Tool Set for Axial Joints | 4 pcs.

12.5  1/2

- for fast and professional changing of the axial joints of cars and light commercial vehicles
- easy assembly of long tie rods because of open construction
- for joint heads Ø 30 - 45 mm
- 3 exchangeable clamping heads for a wide application area (30 - 35, 35 - 40, 40 - 45 mm)
- works with 12.5 mm (1/2") ratchet or 32 mm wrench



Item #	Description
66530	Tool Set for Axial Joints 4 pcs.
66530-2	Clamping Head 35 - 40 mm for BGS 66530

Axial Joint Tool | 28 - 50 mm

12.5  1/2

- for fast and professional changing of the axial joints of cars and light commercial vehicles
- automatic clamping of the joint heads
- easy assembly of long tie rods because of open construction
- saves up to 3 hours of working time
- works with 12.5 mm (1/2") ratchet or 27 mm wrench size



Item #	Description
66526	Axial Joint Tool 28 - 35 mm
66525	Axial Joint Tool 35 - 45 mm
66527	Axial Joint Tool 45 - 50 mm

Clamping Wrench | for Adjusting Track Rods | 14 - 20 mm

- for rusted track rods
- facilitates the track setting
- special mouth mechanism holds track rods from 14 up to 20 mm
- detachable, knurled handle
- length: 390 mm
- surface finish: galvanised, electroplated

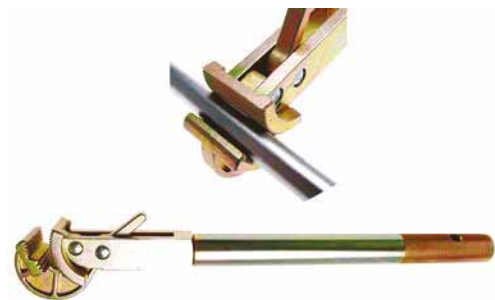

Item #
8267

Clamping Wrench | for Adjusting Track Rods | 40 - 55 mm

- for rusted track rods
- facilitates the track setting
- special mouth mechanism holds track rods from 40 up to 55 mm
- knurled handle, inserted in fastening bolts
- galvanized, zinc coated
- length: 540 mm



Item #
8346

Magnetic Camber Adjustment Tool | with Double Adjustability

- helps to determine the suspension strut angle before disassembly and the adjustment of the same angle after reassembly
- double adjustability: 1st step rough adjustment via 180° clamping mechanism - 2nd step fine adjustment via adjustment screw



Item #
1519

Magnetic Camber Adjustment Tool

- helps to determine the suspension strut angle before disassembly and the adjustment of the same angle after reassembly
- simply attach to the brakedisc with integrated magnets
- adjustable water level included



Item #	Description
1523	Magnetic Camber Adjustment Tool
1523-1	Level for Camber Gauge from BGS 1523
1523-LEER	Empty Case for BGS 1523

Camber / Caster Adjusting Tool | for VW Touareg as of 2003

- for adjusting running gear (camber / caster)
- suitable for VW Touareg as of 2003
- 21 mm 12-point
- to be used as OEM T10188
- satin chrome finish



Item #
8983



Steering Wheel Sleeve Puller | for VW

- is needed to pull the steering shaft sleeve
- when replacing the turn signal / wiper switch unit
- suitable for VW Golf II / III / IV, Jetta, Passat, Polo and Vento since '88
- external hexagon 17.0 mm



Item #
7727

Steering Wheel external Puller | for GM (Opel)

- suitable for Opel models from 2007
- hook foot thickness at the top: 5.5 mm
- hook foot depth: 3.5 mm
- hook length: 12 mm
- hex drive size: SW 17
- clamping depth: 80 mm
- clamping width: 35 mm
- spindle length: 95 mm



Item #	CV	
7739		

Fixing Bolt Set | for VAG Subframe | M12x1.5 | 4 pcs.

- for precisely aligned mounting of the subframe
- Needed e.g. for replacing the rubber bushings and all jobs for which the auxiliary frame (subframe) is removed

suitable for the following models:

- VW Scirocco (2009), EOS (2006)
- VW Golf (2009), Golf Plus (2005)
- VW Jetta (2004 - 2006)
- VW Polo (2002), Fox (2006)
- VW Passat (2006), Passat CL (2009)
- Audi A3 (2004), TT (2007), A4 (2001)
- to be used as OEM T10096



Item #	Description
8306	Fixing Bolt Set for VAG Subframe M12 x 1.5 4 pcs.
8306-LEER	Empty Case for BGS 8306

Fixing Bolt Set | for VAG Subframe | M14x1.5 | 4 pcs.

- for precisely aligned mounting of the subframe
- needed e.g. for replacing the rubber bushings and all jobs for which the auxiliary frame (subframe) is removed
- suitable for VW T5 from 2004
- to be used as OEM T10227



Item #
8715

Clamping Screw Remover | for VAG 4-Wishbone Axles | 6 mm

- suitable for driving out the clamping screws with Ø 6.2 mm as on four-wishbone front axles
- to be used with air hammer kit BGS 3515
- remover 6 mm, length 105 mm
- round shank 10 mm
- length: 190 mm



Item #
8787

Clamping Screw Remover | for VAG 4-Wishbone Axles

- suitable for driving out the clamping screws on four-wishbone front axles on, installed in the Audi A4, A6 and VW Passat
- to be used with air hammer kit BGS 3515
- round shank 10 mm
- 1 release mandrel chisel
- 1 extractor, short
- 1 guide sleeve



Item #
8792

Push Rod Ball point Socket | 12.5 mm (1/2") Drive | Ø 49 mm

12.5  1/2

- for moving and removing of tie rod ends
- suitable for most cars and some trucks
- dimensions of U-shaped opening: 18.5 x 34 mm
- length: 57.5 mm
- internal diameter: 49 mm
- fitting depth: 40 mm



Item #
9156



Steering Wheel Level

- for quick and accurate alignment of the steering wheel
- optimal use in the assembly of steering wheels
- can be used universally for cars, vans and trucks
- increased adjustment range for smaller steering wheel diameter
- material: aluminum

Item #
9977



Wheel Wrench | for Cars | 17mm x 19 mm x 22 mm x 13/16"

- with polished sockets
- hardened and forged
- 16 mm Ø
- hardened
- DIN 899
- arm length: 355 mm
- square 13/16"
- hexagon 17 x 19 x 22 mm
- surface finish: chrome plated

Item #
1455



Wheel Wrench | for Cars | Square | 17 x 19 x 21 x 12.5 mm (1/2")

- chrome plated, hardened
- hardened
- with reinforced middle plate
- according to DIN 3119
- arm length: 355 mm
- square 12.5 mm (1/2")
- hexagon 17 x 19 x 21 mm

Item #
1459



Wheel Wrench, foldable | for Cars | Square | 17 x 19 x 21 x 12.5 mm (1/2")

- higher torque through adjustable joint
- robust design
- foldable
- length 400 mm
- square: 12,5 mm (1/2")
- hexagon: 17 x 19 x 21 mm

Item #
1456



Wheel Bearing Tool Set | 31 pcs.

- universal use on wheel bearings
- allows disassembly and assembly of the wheel hub and the wheel bearings directly on the vehicle
- gentle installation by exerting pressure on the outer bearing ring
- suitable for axle tubes and axles with bearing adjacent to a bund
- pressure plates with diameters of: 50 - 55 - 59 - 63.3 - 66.6 - 70.3 - 71.5 - 73.1 - 73.4 - 74.8 - 77.5 - 81.5 - 83.4 mm
- sleeves with following diameters: 76 - 86 - 91 - 102 mm
- 3 extractor bolts M12 x 1.5
- 1 extractor bolt M14 x 1.5
- spindle 22.2 mm x 300 mm, including thrust bearing (protects against increased friction)
- external hexagon drive 38
- pressure nut 32 x 60 mm
- pressure sleeve Ø 38 x 40 mm
- pressure disk Ø 40 x 3 mm

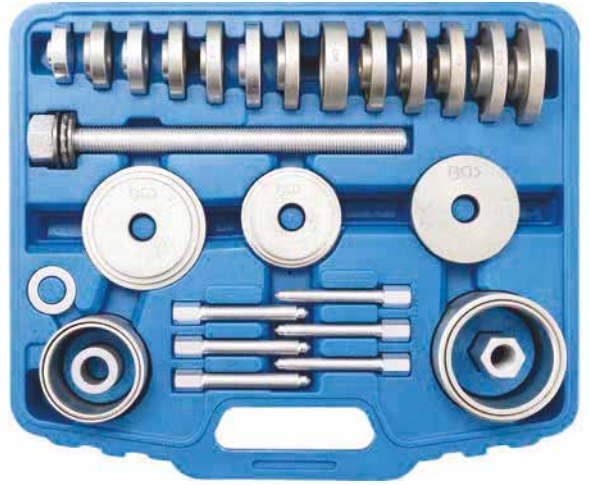

Item #	Description
67301	Wheel Bearing Tool Set 31 pcs.
67301-1	Bearing for BGS 67301
67301-2	Spindle Nut for BGS 67301
67301-3	Spindle for BGS 67301

Pull and Press Sleeve Kit | with 4 Spindles | 26 pcs.

- comprehensive kit for fast and effective removal and installation of wheel bearings & suspension bushes
- reduces the possibility of damaging the bearing and housings
- plates and sleeves can also be used in a common workshop press
- supplied with 4 stepped end plates
- pressure plates: Ø 83 x 20 mm
- 4 screws: M10 x 1.5 - M12 x 1.5 - M14 x 1.5 M16 x 1.5 mm, 450 mm long
- pressure sleeves with outer-Ø 44, 46, 48, 50, 52, 54, 56, 58, 60, 62, 64, 66, 68, 70, 72, 74, 76, 78, 80, 82 mm
- sleeve wall thickness: 5 mm
- sleeve height: 94 mm



Item #	Description
67302	Pull and Press Sleeve Kit with 4 Spindles 26 pcs.
67302-M10	Spindle for BGS 67302 M10
67302-M12	Spindle for BGS 67302 M12
67302-M14	Spindle for BGS 67302 M14
67302-M16	Spindle for BGS 67302 M16
67302-1	Empty Case for BGS 67302

Pull and Press Sleeve Kit | with 4 Spindles | 24 pcs.

- universal type for all car models
- also for assembly or disassembly of silent bearings, rubber- and ball bearings
- also suitable for rubber bushes and rotary shaft seals
- smooth running because of high-quality ball bearing on spindle screw nut
- four 350 mm spindles in M10, M12, M14 and M16
- 20 pressure pads (outer Ø x inner Ø): 44x34 - 46x36 - 48x38 - 50x40 - 52x42 - 54x44 - 56x46 - 58x48 - 60x50 - 62x52 - 64x54 - 66x56 - 68x58 - 70x60 - 72x62 - 74x64 - 76x66 - 78x68 - 80x70 - 82x72



Item #	Description
1514	Pull and Press Sleeve Kit with 4 Spindles 24 pcs.
1514-LEER	Empty Case for BGS 1514
1514-M10	Spindle for Press and Pull Sleeve Kit M10 x 1.5
1514-M12	Spindle for Press and Pull Sleeve Kit M12 x 1.5
1514-M14	Spindle for Press and Pull Sleeve Kit M14 x 1.5
1514-M16	Spindle for Press and Pull Sleeve Kit M16 x 1.5

Wheel Bearing Hub Unit Installing Tools Set | for VAG | Bearing unit Ø 62, 66, 72 mm

- suitable for the following VAG models: Audi A2, VW Lupo / Polo / Fox, Seat Ibiza, Skoda Fabia
 - fits on 62, 66 and 72 mm bearing unit
 - allows mounting directly on the vehicle
 - reduces operating time to the minimum
 - simple and safe handling
 - can also be optionally used with a workshop press
- 1 universal pressure bell
 - 3 pressure pieces
 - 1 spindle unit with ball bearing M20
 - 2 half shells (black) for 72 mm bearing
 - 2 half shells coupling (chrome plated), for 66 mm bearing
 - 2 half shells coupling (anodized), for 62 mm bearing
 - fastening screws for half shells M12 x 1.5
 - fastening screws for half shells M14 x 1.6

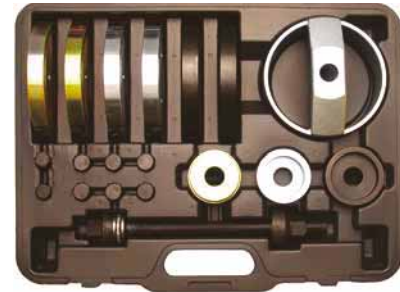

Item #	Description
6250	Wheel Bearing Hub Unit Installing Tools Set for VAG Bearing unit Ø 62, 66, 72 mm
6250-1	Replacement Spindle with ball bearing for BGS 6250

Silent Block Tool Set | for VAG | 18 pcs.

- for replacement of bushes on wishbone / trailing arms, wheel bearing housing, lower wishbone downside / inside
- allows replacement of silent bearings on the vehicle, when installed
- applicable in conjunction with mechanical spindle
- **suitable for the following VAG models:**
 - VW: Golf 5 Plus / Variant / 4-Motion manufactured in 2005-2012, Jetta / Syncro Bj. 2006-2012, Scirocco manufactured in 2009-2012, Beetle manufactured starting from 2012, Eos manufactured in 2006-2012
 - Seat: Altea as of 2004-2012, Leon as of 2006-2012, Toledo as of 2005-2009
 - Audi: A3 / S3 as of 2004-2012, TT / TTS Coupe/Roadster as of 2007-2012
- spherical washers
- adaptor ring
- assembly and disassembly pressure pieces
- assembly centering discs
- centering sleeves and spacer rings
- drive spindle M12 x 1.5 incl. pressure nut

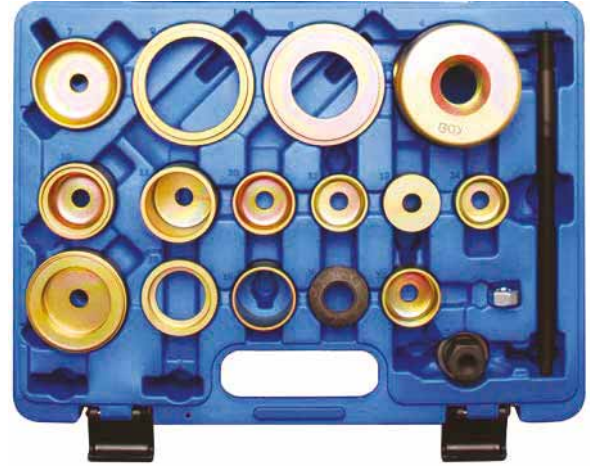

Item #
8778

Silent Block Tool Set | for VW Polo 9N

- for easy and safe removal and replacement of silent blocks on the vehicle
- no removal of the rear axle required, minimizing the workload
- contains spindle, spindle extension, shoulder nut spindle adaptor M10x1.25 made of S45C carbon steel
- spacer, pressure piece, centering ring made from aluminium alloy

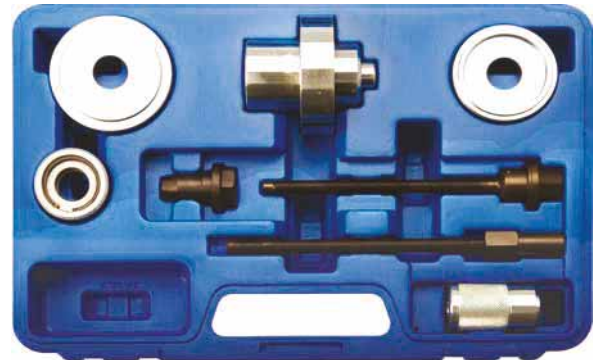

Item #	Description
8253	Silent Block Tool Set for VW Polo 9N
8253-1	Spindle for BGS 8253
8253-2	Spindle Extension for BGS 8253 long version
8253-3	Spindle Nut for BGS 8253

Silent Block Tool Set | for Skoda Fabia, VW Polo

- for proper and quick installation of rubber bushings (silent blocks) on front axle brackets
- suitable for Audi A2, VW Polo IV 9N (2002 - 2005), Skoda Fabia I, Seat Ibiza 6L (2002 - 2006) and Cordoba 2002
- to be used as OEM 3062, 3253/8
- material: steel (S45C)

Item #
8254

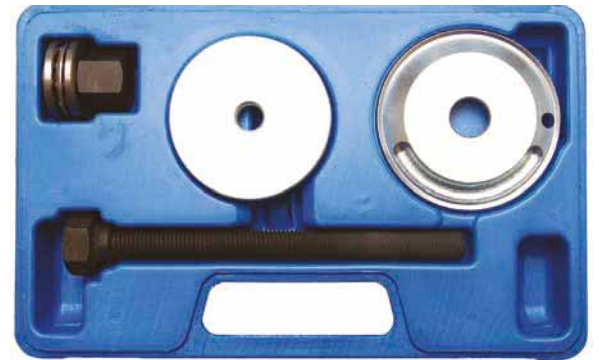

Wheel Bearing Tool Set | for Peugeot, Renault, Citroen

- for replacing wheel bearings on Peugeot, Citroen, Renault models
- includes all tools for disassembly and assembly of wheel bearings

Item #
8739



Wheel Bearing Tool Set | for Audi

- for replacing wheel bearings on VAG models
- suitable for the following models: Audi A3 (8L), A4 (B5), A4 Quattro (B6) rear axle, Audi A6 (4A, 4B), A8 (4D, 4E), TT (8N, 8J), VW Polo (6N), Golf (II, III, IV), Passat, Sharan, T4
- includes all tools for disassembly and assembly of wheel bearings

Item #
8738



Gearbox / Axle / Steering

Wheel Bearing Tool Set | for Mercedes-Benz

- for replacing wheel bearings on Mercedes-Benz cars
- suitable for the following models: Mercedes-Benz 190 (W201), A-class (W168, W169), B-class (W245), C-class (W202, W203), E-class (W210, W124), M-class (W163, W164), S-class (W140), V-class (W639)
- includes all tools for disassembly and assembly of wheel bearings



Item #
8737

Hydraulic Kit for Wheel Bearing Tools | for BGS 8737, 8738, 8739

- in conjunction with the optionally offered wheel bearing tool sets for easy and professional replacing of very tight wheel bearings
- **suitable for:**
 - wheel bearing tool set for Mercedes Benz BGS 8737
 - wheel bearing tool set for VAG models BGS 8738
 - wheel bearing tool set for Peugeot, Citroen, Renault BGS 8739
 - driveshaft assembly tool set for VAG, Mercedes-Benz, BMW, Porsche, Peugeot, Renault, Opel/Vauxhall, etc.
- 2 hydraulic cylinder adaptors
- thrust block
- adaptors
- pressure spindle
- pull spindle
- adaptor plate
- 17T hydraulic cylinder (max. pressure 689 bar/10,000 PSI)



Item #
8788

Wheel Hub Tool Set | for Audi | 90 mm

- facilitates assembly and disassembly of front wheel hubs
- to be used with workshop hydraulic press
- suitable for following Audi models:
 - A4 / S4 Quattro
 - Avant manufactured from 2001 - 2008
 - A6 / S6 Quattro Avant manufactured from 2002 - 2005
 - A8 / S8 Quattro Avant manufactured from 2004 - 2007, R8 manufactured starting from 2007
- 1 pressure plate
- 5 push pins
- 1 pair of disassembly shells
- 1 disassembly pressure piece
- 1 assembly sleeve

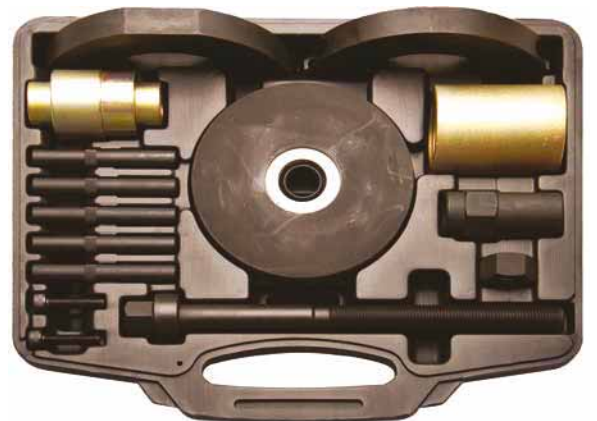

Item #
8709

Wheel Bearing Tool Set | for VAG | wheel Bearing Hub unit Ø 62 / 66 / 72 / 85 mm

- for removing and installing of 62 - 66 - 72 & 85 mm wheel bearing hub units on VAG vehicles
- suitable for following models:
 - Audi A2
 - Volkswagen Lupo, Polo, Fox, Multivan, T6, Transporter, Touareg
 - Skoda Roomster
 - Seat Arosa, Cordoba, Ibiza
- 1 spindle, high-strength, with ball-bearing
- 1 spindle nut
- 3 pairs of mounting shells
- 3 pairs of dismantling shells
- 2 pressure plates
- 6 pressure discs
- 10 pressure bolts
- 4 screws for shells
- 1 hexagon key wrench



Item #
9086

Wheel Bearing Tool Set | for VW

- facilitates assembly and disassembly of wheel hub bearing unit
- high-strength ball bearing fitted spindle
- pressure plate with 8 holes
- 5 pressure bolts
- 1 pair of divided dismantling shells
- 1 dismantling plate
- 1 pair of divided mounting shells
- 1 mounting plate

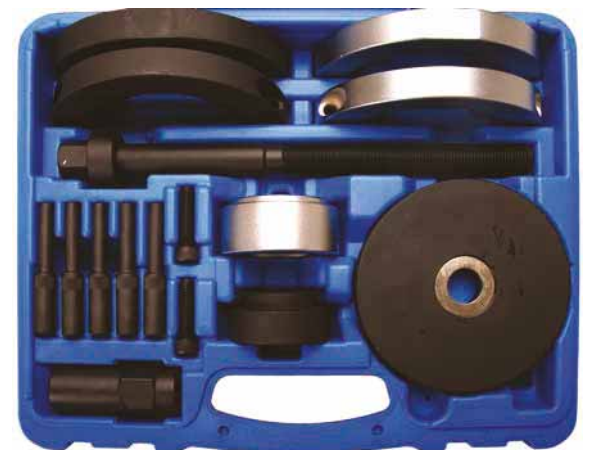

Item #	Description
8321	Wheel Bearing Tool for wheel Bearing Hub Unit for VW 62 mm
8322	Wheel Bearing Tool for wheel Bearing Hub Unit for VW 66 mm
8270	Wheel Bearing Tool for wheel Bearing Hub Unit for VW 72 mm
8324	Wheel Bearing Tool for wheel Bearing Hub Unit for VW 85 mm
8323	Replacement Spindle for BGS 8270, 8321, 8322, 8324

Wheel Hub Puller Tool Set | for Ford, Volvo, Mazda | Ø 78 mm

- facilitates assembly and disassembly of front wheel hub-bearing unit
- suitable for the following models:
 - Ford Focus 2 as of 2004, C-Max as of 2003
 - Volvo C30 as of 2006, C70 Cabriolet as of 2006, S40 as of 2004, V50 as of 2004
 - Mazda 3 (BK) 1.4 / 1.6 / 1.6 Turbo as of 2003
- 1 pressure plate
- 4 pressure bolts
- 2 stop screws
- 1 pair of dismantling shells
- 1 disassembly pressure plate
- 1 pair of mounting shells
- 1 assembly pressure piece
- 1 high-strength ball bearing fitted spindle



Item #
8708

Wheel Bearing Tool Set | for Ford, Land Rover, Volvo | Ø 82 mm

- facilitates assembly and disassembly of wheel hub-bearing unit
- suitable for the following Opel models:
 - Ford Galaxy, S-Max
 - Land Rover Freelander 2
 - Volvo S80, V70, XC60, XC70
- high-strength ball bearing fitted spindle
- pressure plate with 8 holes
- 4 pressure bolts, 8 mm
- 4 pressure bolts, 12 mm
- 1 pair of divided dismantling shells
- 1 dismantling plate
- 1 pair of divided mounting shells
- 1 mounting plate



Item #
9101

Rear Wheel Bearings Tool Set | for VAG | 11 pcs.

- for renewing the plastic and rubber bushes on rear axle when installed
- suitable for the following VAG models:
 - Audi A3 (Bj. 1996 - 2003)
 - Seat Leon (Bj. 1999 - 2006)
 - Seat Toledo (Bj. 1999 - 2006)
 - Škoda Oktavia (Bj. 1996 - 2013)
 - VW Golf 4 (Bj. 1997 - 2006)
 - VW Bora (Bj. 1998 - 2005)
 - VW New Beetle (Bj. 1998 - 2010)
- pressure pieces: Ø 68.7 - 76.6 - 83.8 - 90 - 90.3 - 96.3 - 97.9 mm
- ring Ø 40 mm
- drive spindle M12 x 1.5 with spindle nut



Item #
8779

Rear Axle Bush Tool Set | for VW T5

- for renewing the rear axle bearing
- can be used directly on car, in installed condition
- centering plate with disk and spring
- 2 pressure disks
- adaptor ring
- spindle with spindle nut M14 x 2

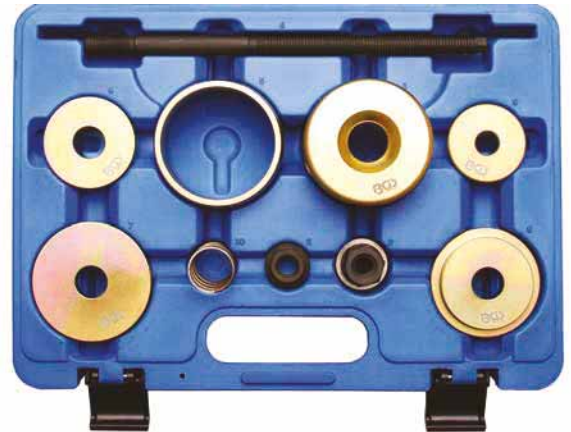

Item #
8780

Rear Axle Bush Tool Set | for VW Golf and Audi A3

- for mounting the rear axle bushes without removing the rear axles
- suitable for Audi A3 (1999 - 2003), Volkswagen Golf IV, Bora (2001 - 2003) 1.4 / 1.6 / 1.8 / 2.0 and 1.9D
- the bushes can be mounted easily using a ratchet wrench or spanner



Item #
8437

Pressure Piece Set | for VW T5 as of 2003 | 4 pcs.

- application: rear-axle suspension arm
- suitable for: VW T5 and T6
- 2 spindle nut M14
- spindle M14 x 2, length: 250 mm
- 22 mm hexagon drive socket
- sleeve Ø 90 x 70 mm
- pressure piece Ø 87 x 64 mm
- step pressure piece Ø 40, 59, 70 mm



Item #
9446



Silentblocks Tool Kit | for Fiat

- used for mounting silentblocks on Fiat rear axles
- suitable for following models:
 - Fiat Stilo (2001 - 2007)
 - Fiat Bravo (as of 2007)
 - Lancia Delta (as of 2008)
- pressure piece with recess and 3 pins
- pressure piece \varnothing 79 x 68 mm
- spindle M12 x 1.75 with bearing nut, length: 255 mm
- 19 mm hexagon drive socket



Item #

8464

Silent Bearing Tool Set | for BMW E38, E39 | 7 pcs.

- for differential suspension bushes at rear axle
- material: steel (S45C)
- spindle M14 x 2 (long), M12 x 1.75 (short), length: 300 mm
- 10 mm drive
- nut 22 mm drive
- bell, inner \varnothing : 60, 70 mm, outer \varnothing : 80 mm, length: 70 mm
- spindle pressure washer, outer \varnothing : 67 mm, thickness: 25 mm
- thrust washer, inner \varnothing : 27 mm, outer \varnothing : 70 mm, thickness: 16 mm
- spindle pressure washer, outer \varnothing : 48 mm, thickness: 16 mm
- axial deep groove ball bearing, outer \varnothing : 42 mm
- profile disc, inner \varnothing : 50 mm, outer \varnothing : 80 mm



Item #

6456

Silent Block Tool Set | for BMW

- disassembly / assembly of the ball joints in rear wheel carrier, suitable for the following BMW models:
 - 5-series E39 / E60 / E61 / E70
 - 6-series E63 / E64
 - 7-series E38 / E65 / E66 / E67
 - 8-series E52
- disassembly / assembly of the ball joints and rubber bearings in the trailing arm, suitable for the following BMW models:
 - 3-series E36 / E46 / E83
 - 5-series E39 / E60 / E61 / E70
 - 6-series E63 / E64
 - 7-series E38 / E65 / E66 / E67
 - 8-series E31 / E52
 - Z4-models E85 / E86
- disassembly / assembly of the rubber bush in rear axle carrier (bottom), rear transmission screw, suitable for the following BMW models:
 - 3-series E36 / E46 / E83
 - 8-series E31
 - Z4-models E85 / E86
- disassembly / assembly of the rubber bearings in the rear transmission suspension front and rear, suitable for the following BMW models:
 - 1-series E81 / E87
 - 3-series E36 / E46 / E83 / E90 / E91 / E92 / E93
 - 5-series E60 / E61
 - 6-series E63 / E64
 - 7-series E38 / E65 / E66 / E67
 - 8-series E31
 - Z4-models E85 / E86
 - MINI Cooper S R53
- spindle M12 x 1.5 with bearing nut, length: 225 mm
- 24 mm hexagon drive socket
- disc, 48, 55, 65 mm
- bell, inner Ø: 47 mm, outer Ø: 55 mm, length: 72 mm
- bell, inner Ø: 50 mm, outer Ø: 64 mm, length: 70 mm
- bell, stepped, inner Ø: 36, 40 mm, outer Ø: 45 mm, length: 30 mm
- bell, stepped, inner Ø: 47, 53 mm, outer Ø: 58 mm, length: 43 mm
- bell, stepped, inner Ø: 47, 53 mm, outer Ø: 58 mm, length: 61 mm
- bell, inner Ø: 32 mm, outer Ø: 46 mm, length: 26 mm
- bell, inner Ø: 46 mm, outer Ø: 55 mm, length: 32 mm
- bell, inner Ø: 47 mm, outer Ø: 51 mm, length: 35 mm
- bell, flattened, inner Ø: 47 mm, outer Ø: 55 mm, length: 32 mm
- disc, stepped, flattened, inner Ø: 57 mm, outer Ø: 70 mm, thickness: 13 mm
- sleeve, 1/3 open, inner Ø: 59 mm, outer Ø: 70 mm, length: 55 mm



Item #
8579

Rear Axle Bushings Tool | for BMW 5 & 7 series

- for renewing the rear ball joint bushes
- assembly and disassembly
- suitable for BMW 5-series (E39), 7-series (E38)
- high-strength spindle
- hexagon nut with collar
- external hexagon drive: 26 mm
- dismantling pressure sleeve
- dismantling holding sleeve, with bearing
- assembly holding sleeve
- mounting pressure sleeve



Item #
8486

Wishbone Hydro Bearings Tool Set | for MINI

- for replacing the bush on the front axle wishbone
- no need to remove the wishbone
- suitable for MINI One, Cooper, Cooper S(R50, R52, R53, R55, R56)
- to be used as BMW OEM 315150
- spindle M18 x 1.5 - M16 x 1.5, length: 190 mm
- spindle nut M18, mounted type
- 27 mm hexagon drive socket
- bell, inner Ø: 67 mm, outer Ø: 79 mm, length: 75 mm
- thrust washer, internal thread M16 x 1.5, outside diameter: 66 mm
- thrust washer, inside Ø: 68 mm, outside Ø: 80 mm
- thrust washer, flattened, inner thread M16 x 1.5, outer Ø: 80 mm

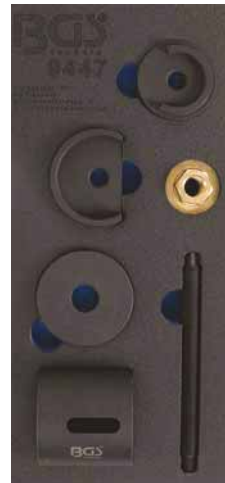

Item #	 
9447	

Wishbone Bushing Tool | for MINI

- for easy removal / installation of the front control arm bush without removing the control arm
- suitable for MINI One, Cooper, Cooper S (2001), R50 / R53 Chassis W10 / W11 / W17
- to be used for BMW OE 31126757551
- spindle M16 x 2, M12 x 1.75
- spindle nut M16
- 24 mm hexagon drive socket
- ball bearing 51103
- sleeve, inner Ø: 67 mm, outer Ø: 79 mm, length: 75 mm
- disc, inner Ø: 17 mm, outer Ø: 78 mm
- thrust washer, flattened, internal thread M12 x 1.75, outside diameter: 77 mm
- thrust washer, flattened, inner Ø 68 mm, outer Ø: 77 mm
- thrust washer, internal thread M12 x 1.75, outer Ø: 65 mm



Item #
8842

Rear Axle Bush Tool Set | for BMW E36, E46, E85

- for easy and gentle replacing of rear axle bushes on BMW models E36, E46, E85
- consists of disassembly and assembly pressure pieces, ball bearings, high-strength spindle

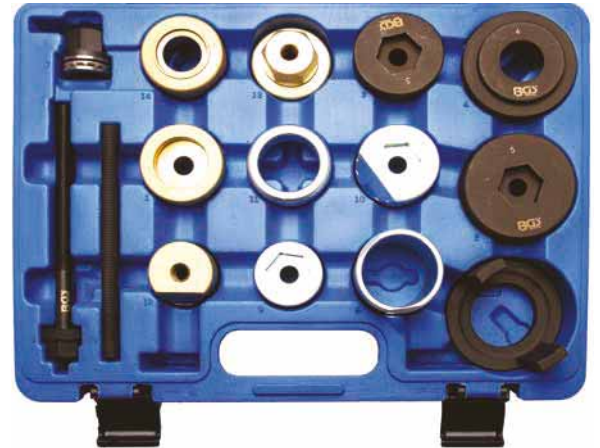

Item #
8776

Rear Axle Bush Tool | for BMW X 5

- for removal and installing of the rear axle carrier rubber bushings
- allows renewing of the bushes without removing of the carrier
- suitable for BMW X5 E53



Item #
8845

Trailing Arm Bushing Tool Set | for BMW

- prevents damage to new bushings
- disassembly of the trailing arm is not required
- facilitates mounting and reduces installation time
- contains: disassembly and assembly pressure piece, counter holding sleeve, counter holding sleeve plate, mounting ring and tool for tensioning the bushing
- suitable for BMW (manufactured after 2007) E85, E89, E92



Item #
8716

Rear Axle Bush Tool Set | for Renault Laguna II

- for removal, installation and alignment of rear axle bushes on Renault Laguna II
- high-strength ball bearing fitted spindle

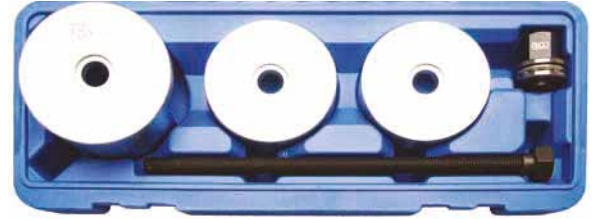

Item #
8770

Rear Axle Bush Tool | for Ford Mondeo

- for removing and installing the sub frame bushes on rear axle (for bodywork)
- suitable for Ford Mondeo MK3 01-07 estate and limousine



Item #
8843

Trailing Arm Silent Block Tool Set | for Ford / Mazda / Volvo

- for replacing the rear trailing arm silent bush (Ø 60 mm) directly on vehicle, dismantling of the trailing arm is not required
- no need to replace the complete trailing arm
- suitable for the following models:
 - Ford Focus 1998 - 2004
 - Ford Focus II starting from 2004
 - Ford C-Max 2003 - 2007
 - Ford Kuga starting from 2008
 - Mazda 3 starting from 2003
 - Mazda 5 starting from 2005
 - Volvo C30 starting from 2006
 - Volvo S40 II starting from 2004
 - Volvo V50 starting from 2004



Item #
9444



Front Wheel Bearings Puller | for Ford Transit

- for removal of the front wheel bearing unit and for removing the wheel hub
- allows renewing of the bearing without replacing the wheel hub
- puller with retaining key
- screw set (5 pcs.)
- pressure plate (large)
- pressure plate (small)
- spindle with hexagon drive



Item #	Description
8707	Front Wheel Bearing Puller Set for Ford Transit
8707-1	Puller Feet for Front Wheel Bearing Puller for BGS 8707 for Ford
8707-2	Spindle for front wheel bearing Puller for BGS 8707 for Ford

Bearing Ring Removal Tool | for Ford Transit (as of 2006)

- for removing the inner bearing ring on wheel hub
- suitable for Ford Transit with front wheel drive
- half shells, to grip the bearing ring
- 3 connecting bolts, to connect the half-shells with tool (BGS 8707)
- screw / nut / washer set for connecting the half shells



Item #	Image	Quantity
9220		1/3

Rear Trailing Arm Bush Tool | for Ford Fiesta / Ka

- for removing / installation of the rear trailing arm bush
- suitable for Ford Fiesta / Ka (from 1996)
- can be used directly on vehicle, without removing the trailing arm
- spindle
- spindle nut
- pushing cup
- reception cup
- insertion cup
- spindle nut with bearing



Item #
8846

Front Wishbone Bush Tool | for VAG

- for the removal / installation of the rear bush on the front lower wishbone
- can be used without removing the wishbone
- suitable for the following models: Seat Cordoba III (2003), Skoda Fabia (2000), VW Polo IV (2002)
- spindle nut with 24 mm hexagon drive



Item #
8589

Silent Block Tool | for VAG Rear Axle

- for changing the knuckle silent blocks on rear axle
- requires less manual power due to ball bearing
- suitable for the following vehicles:
 - Audi A3
 - VW Eos, Caddy III, Golf V, Jetta III, Passat, Tiguan, Touran, Sharan
 - Seat Altea, Leon, Toledo, Alhambra
 - Skoda Oktavia, Superb, Yeti



Item #
8952

Wishbone Bushing Tool | for Mercedes-Benz W410

- for renewing the rear control arm bushing
- suitable for all Mercedes-Benz W170 (SLK) and W202 (C-Class) models



Item #
8734

Wishbone Bushing Tool Set | for Mercedes-Benz W210

- for renewing the rear control arm bushing
- suitable for all Mercedes-Benz models of the E-class W210



Item #
8733

Wishbone Bushing Tool | for Mercedes-Benz W170 / W202

- for renewing the rear control arm bushing
- suitable for all Mercedes-Benz W170 (SKL) and W202 (C-class) models



Item #
8735

Wheel Bearing Tool Set | for Mercedes-Benz | 4 pcs.

- for removing / installing the rear wheel bearing and rear axle flange on Mercedes-Benz types W124, 129 201, 202



Item #
64100

Rear Axle Adjusting Tool Set | for Mercedes-Benz | 3 pcs.

- for adjusting the rear axle tracking
- suitable for the hard-to-reach adjustment screws
- quick and precise work that does not take much time and effort
- without this tool the precise adjustment of the tracking is almost impossible
- suitable for Mercedes-Benz C-Class (W203) & S-Class, also for older models with under body panels and vehicles with level sensors
- twice angled
- 2 interchangeable spline bits M10 & M12



Item #	
9372	

Rear Trailing Arm Bush Tool | for BMW E36 / E46

- suitable for BMW 3-series (E36, E46, E46 Compact)
- for removing original bushes and removing & installing new style slotted bushes
- hardened



Item #
8480

Rear Wishbone Bush Tool Set | for Ford, Mazda, Volvo

- for disassembly and assembly of the rear trailing arm bushes
- removal and installation can be done directly on the car
- for the following models:
 - Ford Focus MK1 / MKII (as of 1998 - 2007), Kuga (before 2008), C-Max (as of 2007)
 - Mazda 3 saloon / hatchback (BK) (2003 - 2008), Mazda 5 (CR, CW), Mazda MPV (2005)
 - Volvo V50 estate / hatchback (2004 - 2012), Volvo S40 MK2 saloon (2003 - 2012)



Item #
8849

Trailing Arm Bush Tool Set | for Opel Vectra

- for removing and installing the rear upper and lower bushes on trailing arm suspensions
- suitable for following models: Opel (Vauxhall) Vectra 1.6, 1.8, 2.0 (1995-) and 2.5 (1996-)
- can be used directly on car, without removing the trailing arm
- nut with thrust bearing



Item #
8875

Silent Block Tool Set | for Opel / Vauxhall | 5 pcs.

- enables dismantling and assembly of the rear axle silent block directly on the vehicle without removal of the rear axle
- suitable for the following Opel / Vauxhall models:
Astra H (2004-2014), Meriva B (2010-), Zafira B (2005-2014)
- can be used on silent blocks with the following OE part numbers:

- Opel: 5402637, 0402952, 402952
- Vauxhall: 13110418, 13267215
- GM: 13110418, 13267215
- AUTOMEGA: 3054020637, 3004020952, 300402952
- JP Group: 1250101100
- Monroe: L24843
- Swag: 40930604
- Triscan: 850024843



Item #
9423

Rear Axle Guide Bushing Tool | BMW 5 & 7 SERIES

- allows replacement of rear axle guide bushings (ball bushes)
- suitable for models E39 und E38
- assembly pressure plate
- disassembly pressure plate
- spindle and counterholding sleeve



Item #
8481

Trailing Arm Bushing Tool Set | for BMW rear axle | 10 pcs.

- for replacing the trailing arm bushings and trailing arm in wheel carrier bushing
- suitable for BMW models 1 and 3 (2004 - 2012) series: E81 / E82 / E83 / E85 / E86 / E87 / E88 / F20 / E90 / E91 / E92 / E93
- split bush compressor to be used as OEM 334450
- camber arm mounting extraction / insertion tool to be used as OEM 334460
- trailing arm mounting extraction / insertion tool to be used as OEM 334480



Item #
8829

Silent Block Tool Set | for Ford Mondeo rear axles | 6 pcs.

- for replacing the individual bushes in the rear axle trailing arms
- removal of trailing arm, brake or axle parts is not required
- suitable for Ford Mondeo built from 2000 - 2007
- spindle with M12 x 1.75 thread

Item #
64111



Bearing and Bush Driver Set | 52 pcs.

- suitable for mounting of bearings, sealing rings and rubbers
- particularly useful when used with a hydraulic press
- mounting pads in following sizes: 18 to 65 mm (1 mm steps) and 74 mm 12 mm Ø bore
- 180 mm metal handle for use with hammer
- material: carbon steel

Item #
8467



Bearing and Bush Driver Set | XXL | 21 pcs.

- suitable for mounting bearings and sealing rings
- particularly useful when used with a hydraulic press
- 17 mounting pads Ø 70 to 150 mm (5 mm steps)
- 273 mm metal handle for use with a hammer
- material: carbon steel

Item #
8736



Bearing and Bush Driver Set | Nylon | 36 pcs.

- for non-damage mounting of bearings and sealing rings
- suitable for most bearings
- 33 nylon and 3 metal mounting sleeves
- pressure piece sizes: 10-26 mm / 10-30 mm / 10-35 mm / 12-28 mm / 12-32 mm / 12-37 mm / 15-32 mm / 15-35 mm / 15-42 mm / 17-35 mm / 17-40 mm / 17-47 mm / 20-42 mm / 20-47 mm / 20-52 mm / 25-47 mm / 25-52 mm / 25-62 mm / 30-55 mm / 30-62 mm / 30-72 mm / 35-62 mm / 35-72 mm / 35-82 mm / 40-68 mm / 40-60 mm / 40-90 mm / 45-75 mm / 45-85 mm / 50-80 mm / 50-90 mm
- pressure disk sizes 45-100 mm / 50-110 mm

Item #
8670



Bearing and Bush Driver Set | 10 pcs.

- for flush fitting and centering bearing rings and tapered roller bearings
- incl. one pin and pressure pieces with the following external diameters: 40 - 44 - 50 - 59 - 63 - 65 - 72 - 76 - 81 mm
- reception 14 mm

Item #	Description
1522	Bearing and Bush Driver Set 10 pcs.
1522-10	Handle from BGS 1522

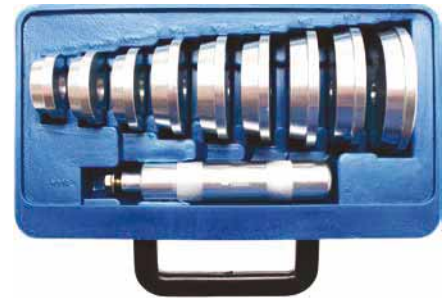

Bearing and Bush Driver Set | 16 pcs.

- made from aluminium
- 3 drift pins: Ø 11 - 16 - 21 mm
- 13 pressure pieces:
 - 10 mm internal diameter x 12 mm external diameter
 - 12 mm internal diameter x 14 mm external diameter
 - 14 mm internal diameter x 16 mm external diameter
 - 15 mm internal diameter x 17 mm external diameter
 - 16 mm internal diameter x 18 mm external diameter
 - 18 mm internal diameter x 20 mm external diameter
 - 19 mm internal diameter x 21 mm external diameter
 - 20 mm internal diameter x 22 mm external diameter
 - 22 mm internal diameter x 24 mm external diameter
 - 25 mm internal diameter x 27 mm external diameter
 - 26 mm internal diameter x 28 mm external diameter
 - 28 mm internal diameter x 30 mm external diameter
 - 30 mm internal diameter x 32 mm external diameter

Item #
1524

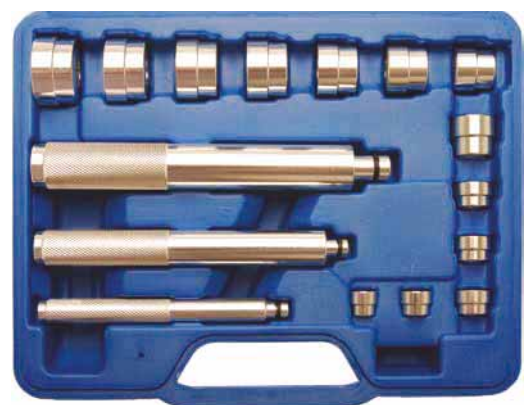

Inner Wheel Bearing Puller Set | 40 - 62 mm | 8 pcs.

- allows removal of the flat-fitting bearing inner ring of the wheel hub
- universally applicable for most vehicle types and bearing inner rings with 40 - 45 mm ring diameter
- 4 pullers: 40 - 45 mm / 45 - 51 mm / 55 - 61 mm / 50 - 55 mm
- 2 ring wrenches
- main body
- spindle M20 x 1.5



Item #
7763

Bearing Inner Ring Puller | 68 mm

- for removing of e.g. inner wheel bearing rings on wheel hubs
- the bearing rings usually remain on the wheel hubs when disassembling the wheel bearing
- clamping device presses puller feet safely behind the component to be removed
- pressure piece diameter: 25 x 30 mm
- pulling width: 68 mm
- puller depth 60 mm



Item #
9331

Pressing Frame

- M18 spindle suitable for impact wrench use
- can be used with hydraulic ram BGS 7721-X
- max. pressing width: 220 mm
- frame dimensions: 340 x 185 mm
- distance from spindle to frame: 80 mm
- suitable for use with pull and pressure sleeve sets BGS 1514



Item #	Description
3051	Pressing Frame
3051-LEER	Empty Case for BGS 3051

Body and Fender Repair Kit | hydraulic | 10 t

- for special operations on car bodies
- for pressing, clamping and spreading of body parts
- maximum pressure: 10 t
- packed in carrying case with wheels
- pressure cylinder, length: 385 - 540 mm
- pressure cylinder extensions, length: 125, 250, 455, 685 mm
- spreader, 115 mm leg
- pressure plate, 165 x 95 mm
- pressure piece, round, Ø 50 mm
- pressure piece, roof-shaped
- pressure piece with round and tapered profile
- rubber ball, Ø 80 mm
- 80 mm side-thrust piece (mounting on piston)
- 80 mm side-thrust piece (mounting on cylinder)

Item #	Description
1689	Body and Fender Repair Kit hydraulic 10 t
1689-leer	Empty Case for BGS 1689
1689-1	Hydraulic Pump for BGS 1689 10 t
1689-2	Hydraulic Cylinder for BGS 1689 10 t.

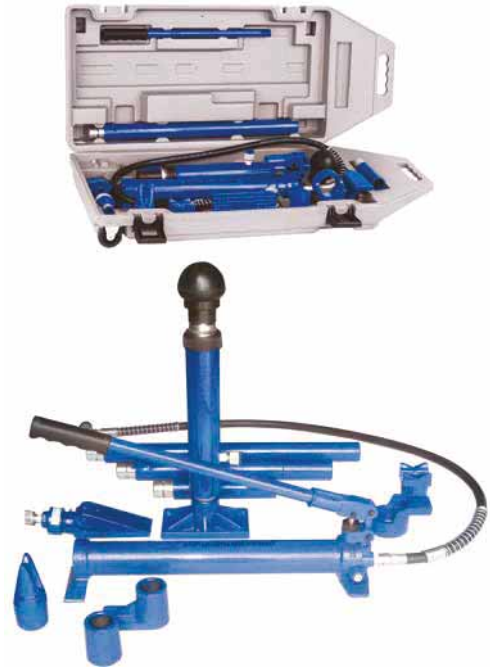

Body and Fender Repair Kit | hydraulic | 4 t

- for straightening work on car bodies
- for pressing, clamping and spreading of body parts
- maximum pressure: 4 t
- 350 mm hydraulic pump length
- 75 mm hydraulic cylinder pressing width
- in plastic case

Item #	Description
1688	Body and Fender Repair Kit hydraulic 4 t
1688-1	Hydraulic Pump for BGS 1688 4 t
1688-2	Hydraulic Cylinder for BGS 1688 4 t.
1689-3	Spreader for BGS 1688, 1689 4 t
1688-4	Rubber Pressure Head for BGS 1688
1688-LEER	Empty Case for BGS 1688



Folding bench | 600 mm

- for folding of metal sheets up to 600 mm width and 1.2 mm thickness
- support for mounting in a bench vice
- with angle stop and angle measurement

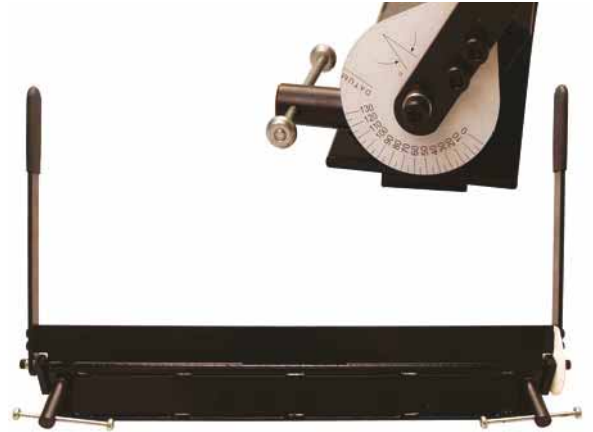

Item #
8687

Fender Flaring Tool

- for expanding the fender size
- is often required when lowering the vehicle and changing the wheel-tire combination
- telescopic boom arm with 180° swiveling pressure roller
- suitable for 4- and 5- bolt wheel hubs
- suitable for M12 wheel nuts/screws and cars with pitch circle diameters from 95 to 120 mm
- weight: 7.5 kg



Item #
3525

Cycle and Fender Crimp Pliers | 310 mm

- for edge coiling of sharp fender inner edges, preventing damage to tires when cushioning
- plastic jaws for smooth application
- is required for e.g. lowered vehicles or when changing the wheel/tire combination
- a dismantling of wheels can be omitted in most cases
- length: 310 mm



Item #
8682

Combination Edge Setter and Folding Pliers | straight | 280 mm

- for seaming sheet metal
- maximum jaw width 60 mm
- handle dip insulated
- length: 280 mm

Item #
6160



Combination Edge Setter and Folding Pliers | 45° offset | 280 mm

- for removing sheet metal
- maximum jaw width 60 mm
- handle dip insulated
- length: 280 mm

Item #
6161



Combination Edge Setter and Folding Pliers | 90° offset | 280 mm

- for seaming sheet metal
- maximum jaw width 60 mm
- handle dip insulated
- length: 280 mm

Item #
6162

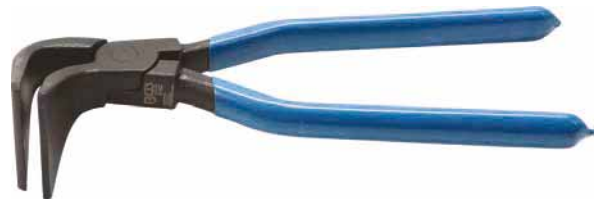

Edge Setter Pliers | for Metal Sheets up to 1 mm

- self opening
- crimping capacity: 13 mm
- for reducing metal sheet edges up to 1 mm
- for car body repairs
- comfortable and robust rubber handle
- max. power transmission with min. effort
- length: 300 mm
- jaw width: 22 mm

Item #
6140



Hole Punch Pliers Folded Workpieces

- self opening
- 5 mm matrix
- for punching straight and bevelled sheets up to 1.25 mm material thickness
- throat 40 mm
- special pliers for punching and retracting folded workpieces
- length: 280 mm

Item #
6141



Combination Edge Setter / Hole Punch Pliers

- self opening
- flexible jaw, 5 mm punch
- for setting edges in sheets up to 1 mm thickness and for punching holes in sheets for spot welding operations
- length 285 mm
- jaw size: 13 mm deep
- jaw width: 22 mm

Item #	Description
6120	Combination Edge Setter / Hole Punch Pliers
6121	Spare Punch for Punch Pliers
6122	Spare Punch for Beveling and Punch Pliers 6 mm



Claw for Car Body Alignment | 120 mm | two directions of pull | max. 5 t, side 3 t

- no twisting by safety device
- claw width: approx. 120 mm with 15 mm center opening
- clamping depth: 32 mm
- length: 180 mm

Item #
2900

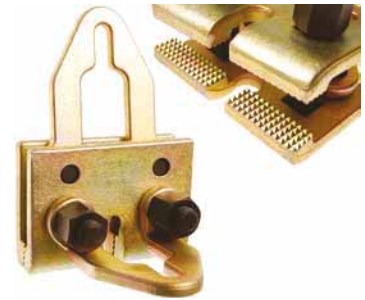

Claw for Car Body Alignment | 120 mm | one pulling direction | max. 5 t

- no twisting by safety device
- claw width: approx. 120 mm with 15 mm center opening
- clamping depth: 32 mm
- length: 180 mm

Item #
2901

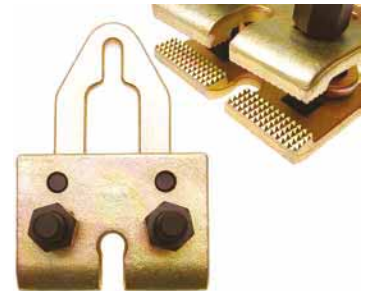

Claw for Car Body Alignment | 45 mm | one pulling direction | max. 5 t

- no twisting by safety device
- with extra big mouth
- claw width: 45 mm
- clamping depth: 40 mm
- holding power of the claw is higher when pulled
- 35 x 40 mm eyelet opening
- length: 230 mm

Item #
2902



Claw for Car Body Alignment | 35 mm | one pulling direction | max. 3 t

- no twisting by safety device
- claw width: 35 mm
- clamping depth: 60 mm
- holding power of the claw is automatical higher when pulling
- 35 x 40 mm eyelet opening
- length: 220 mm

Item #
2903

**Car Body Alignment Claw | 43 mm | two directions of pull | max. 5 t, side 2 t**

- no twisting by safety device
- claw width: 43 mm
- clamping depth: 22 mm
- holding power of the claw is automatical higher when pulling
- 35 x 42 mm eyelet opening
- length: 210 mm

Item #
2904

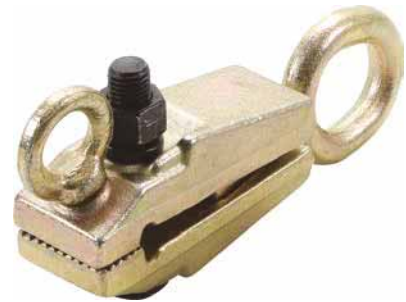
**Car Body Alignment Claw | 43 mm | one pulling direction | max. 5 t**

- no twisting by safety device
- claw width: 43 mm
- clamping depth: 22 mm
- holding power of the claw is automatical higher when pulling
- 35 x 42 mm eyelet opening
- length: 210 mm

Item #
2905

**Claw for Car Body Alignment | 90° | 36 mm | one pulling direction | max. 2 t**

- no twisting by safety device
- claw type: 2 clamp jaws 90°, 2x 20 mm
- claw width: 36 mm
- clamping depth: 29 mm
- holding power of the claw is automatical higher when pulling
- 35 x 40 mm eyelet opening
- length: 190 mm

Item #
2906



Claw for Car Body Alignment | 90° angled | 40 mm | one pulling direction | max. 2 to.

- no twisting by safety device
- claw type: 90° angled
- claw width: 40 mm
- clamping depth: 28 mm
- fixed eyelet
- (25 x 35) x 50 mm eyelet opening
- length: 165 mm

Item #
2907



Body Repair Set | 7 pcs.

- heavy duty hickory handles
- 3 panel beating hammers
- 4 panel irons

Item #	Description
1672	Body Repair Set 7 pcs.
1672-1	Body Hammer round, flat Head / tip, tapered fin
1672-2	Body Hammer round, flat Head / square, flat Head
1672-3	Body Hammer round, flat Head / straight, horizontal fin
1672-4	Hand Anvil wedge shape curved
1672-5	Hand Anvil ledge shape
1672-6	Hand Anvil small radius
1672-7	Hand Anvil large radius



Ball Pein Hammers

- special dent removal head shape
- fibre glass shaft
- with rounded cross and rounded peen

Item #	Description
3870	Ball Pein Hammer 225 g
3871	Ball Pein Hammer 450 g
3872	Ball Pein Hammer 700 g
3873	Ball Pein Hammer 900 g



Bumping Hammer | 225 g

- for removing dents without distortion
- 3-piece hammer face, flexible
- material handle: wood
- head weight: 225 g

Item #
1676



Car Body Repair Hammer | Ø 38 mm | 225 mm

- chequered hammer face for removing dents without distortion
- length: 310 mm
- material handle: hickory
- head weight: 225 g

Item #
1675



Hand Grinder | 105 x 210 mm

- for clamping sandpaper
- extra holding holes on the sides for comfortable grip
- fixing clamps on both sides

Item #
1638



Panel Beating Iron | "3-IN-1"

- ideal for dent removal

Item #
1685



Contour Gauge | 250 mm

- for quickly copying and transferring bodywork contours
- useful for for carpenters and for modelling
- side metal holder for optional attachment of second gauge
- with 4 magnets on the reverse
- max. measuring depth: 30 mm
- max. measuring width: 250 mm
- length: 260 mm
- width: 282 mm

Item #
8025



Contour Gauge | metal | 125 mm

- for quickly copying and transferring bodywork contours
- useful for for carpenters and for modelling
- max. measuring depth: 30 mm
- max. measuring width: 125 mm
- material: metal

Item #
8149



Gap Gauges Set | 3 pcs.

- useful for body work such as fitting doors, fenders and other body parts and for the adaptation and installation of car windows and body parts
- adaptation to body by pivoting, ball-bearing construction
- includes 3 gauges with 10 gauge blades each, 1 mm thickness
- with mounting suction cup and flexible gooseneck



Item #
8763

Car Body File Frame

- adjustable
- for 350 mm files, sold without file
- aluminium diecast



Item #
3216

Body File Sheets

- different surfaces



Item #	Description
3217	Body File Sheet coarse half-round milled 350 x 35 x 4 mm
3217-1	Body File Sheet fine radially milled 350 x 35 x 4 mm
3217-2	Body File Sheet coarse obliquely milled 350 x 35 x 4 mm
3217-3	Body File Sheet fine obliquely milled 350 x 35 x 4 mm

Assembly Tool Set for Parking Sensor Holders

- for replacing defective parking sensor holders or for punching holes in unprepared plastic bumpers
- hole punch Ø 18.2 mm
- hole punch Ø 26.0 mm
- locator pin, red
- locator pin, silver
- holding fixture, 4 pcs.
- HSS twist drill Ø 10.2 mm



Item #
9088



Plastic Repair Set | with Gas Soldering Iron

- for repairing plastic parts, e.g. bumpers, wheel inner fenders, headlight housings, engine covers, motorcycle paneling, etc.
- with different welding rods, for use on following plastics:
 - Acrylic-Butadiene-Styrene (ABS), polypropylene (PP), polyethylene (PE) and Polystyrene (PS)
 - polypropylene (PP)
 - polyethylene (PE)
 - polystyrene (PS)
- 1 soldering iron
- 2 welding heads, 9 mm / 12 mm
- 1 screwdriver, 3 x 50 mm
- 1 cleaning brush
- 1 cleaning rod
- 3 stainless steel meshes for reinforcement, 100 x 60 mm
- 6 welding rods for ABS plastic, length 170 mm
- 6 welding rods for PS plastic, length 170 mm
- 6 welding rods for PE plastic, length 170 mm
- 6 welding rods for PP plastic, length 170 mm

Item #
9388



Consumables | for plastic Repair Set BGS 9388

- accessory kit for plastic repair set with gas soldering iron BGS 9388
- 2 welding heads, 9 mm and 12 mm
- 1 screwdriver, 3 x 50 mm
- 1 cleaning brush
- 1 cleaning rod
- 3 stainless steel meshes for reinforcement, 100 x 60 mm
- 6 welding rods for ABS plastic, length 170 mm
- 6 welding rods for PS plastic, length 170 mm
- 6 welding rods for PE plastic, length 170 mm
- 6 welding rods for PP plastic, length 170 mm

Item #
9389



Windshield Removal Tool Kit | 14 pcs.

- ideal for the correct disassembly of glued front windscreens as well as most rear and side screens
- for cutting the vinyl adhesive and urethane around windshields
- 600 mm weather strip cutting knife
- 300 mm weather strip cutting knife
- replaceable blade pinchweld scraper, 300 mm (3 pcs., 1.25 - 1.5 - 2 cm)
- extra wide pinchweld scraper
- triangle wire on roll, 22 m
- 2-piece wire gripping handles
- windshield removal tool
- hexagon wrench
- wire feeder tool
- trim pad remover
- windshield moulding release tool

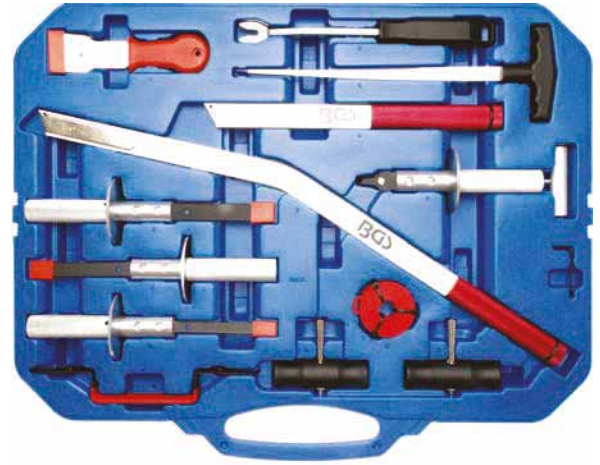

Item #
69500

Windshield Removing Tool Set

- for professional removing of glued car windshields
- wire pull system with deflection pulley
- 150 mm suction discs with hand pump provide a firm grip on the windshield
- cutting wire reel with 10 mm (3/8") drive
- max. suction head capacity: 50 kg (per head)
- to be used with e.g. window cutting wire (BGS 8583)



Item #
69505

Windscreen Assembly Set | 5 pcs.

- for windcreens with conventional rubber seal
- roll handle for easy redirecting the rope
- ball handle 210 mm, angled for non-destructive lifting of the sealing rubber
- hook handle 210 mm, 45° angled
- hook handle 270 mm, 90° angled, facilitates the installation of the sealing rubber
- guide handle 220 mm, for tracking the installation rope
- installation rope 6.0 m



Item #
8002



Windscreen Removal Set | 7 pcs.

- for glued windscreens
- panel-removal tool with handle, 275 mm
- piercing awl, 330 mm
- handles for cutting wire | 2 pcs.
- cutting wire, 180 cm
- double hook handle, 240 mm
- pull scraper with handle and pull rope



Item #
8004



Tool for Removing glued Car Windows

- hardened blade
- with drawstring
- handle material: aluminium



Item #	Description
7999	Tool for Removing glued Car Windows
8001	Spare Blade for BGS 7999

Pull Handles for Windscreen Cutting Wire | 2 pcs.



Item #
8003



Square Window Cutting Wire | 50 m

- rust-proof
- for use with handles for windscreen cutting wire BGS 8003 and windscreen removal set BGS 8022
- suitable as replacement wire for e.g. BGS 69500, 8003, 8004 , 8022



Item #
8006

Window Cutting Wire | knotted | 25 m

- flexible
- for cutting out glued windows
- braided from 3 stainless steel wires
- length 25 m
- thickness 0.9 mm
- suitable as replacement wire for e.g. BGS 69500, 69505, 8003, 8004 , 8022



Item #
8583



Windshield Seal Nylon Cutting Wire | 50 m

- for damage-free cutting of glued windshields
- excellent cutting performance, comparable to conventional metal-cutting wires
- soft and flexible for preventing damage to painted and sensitive surfaces
- especially suitable for windshield removing tool set (BGS 69505)
- can also be used as OEM tool VAS 861 001 / 1A
- diameter: 1.3 mm
- length: 50 m



Item #
9115



Windscreen Removal Tool Set | 4 pcs.

- 2 handles
- 22 m triangle windscreen cutting wire, stainless
- 1 internal hexagon key for adjusting the wire



Item #
8022



Molding Installer Tool

- for easy installation of moulding / rubber strips on car windows
- moulding / rubber strips are pulled through the pane by nylon roller, allows tight strip installation
- acrylic made holder for control during assembly



Item #
8860

Wire-through Testing Probe | with T-Handle

- stainless steel tube for pushing through the cutting wire
- length: 100 mm
- handle material: aluminium

Item #
67200

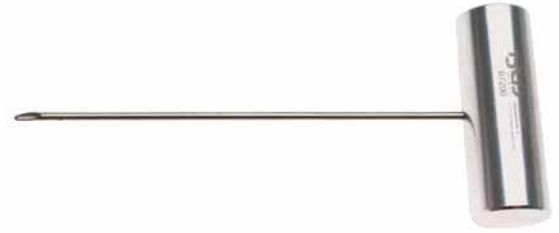

Cutting Wire Insertion Tool | for Windscreen removal

- for counterholding the cutting wire inside the car
- suitable for all glued car windshields
- long angled shaft reduces the risk of damaging the car interior
- ergonomically shaped handle
- wire is clamped by screw
- blade length: 130 mm

Item #
67201

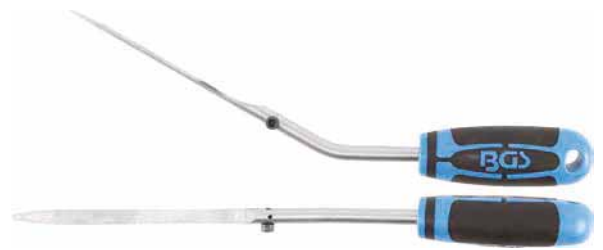

Parting Awl | 330 mm

- adapts to curved surfaces, making it easier to insert wires in vehicles with deep cockpits
- for powerful piercing of the disc seal and threading the cutting wire
- wire insertion is made easier by the fork opening
- slotted head
- spring steel blade
- T-handle for easy operation
- length: 330 mm

Item #
67202



Dashboard Protector | 4 pcs.

- to protect the dashboard when e.g. removing the windshield
- with handle
- made of high-strength plastic
- protection panel, slightly rounded lip, (W x L) 265 x 205 mm
- protection panel, straight, (W x L) 265 x 205 mm
- protection panel, slightly rounded lip, (W x L) 455 x 305 mm
- protection panel, straight, (W x L) 455 x 305 mm

Item #
7685



Windshield Carrying Tool Cart

- extremely useful for transporting / storing windows and tools
- 3 shelf levels, plate size: 500 x 380mm
- dimensions (W x D x H): 685 x 435 x 940 mm
- 4 rubber pads for safe storing of windshield
- 4 swivel castors, 2 with brakes
- 2 handles
- made of lightweight plastic
- max. weight capacity: 50 kg



Item #
8789

Windshield Installation Frame | with Swivable Suction Cups

- especially suitable for disassembly/assembly of larger windshields
- 4 suction cups with hand-operated vacuum pump (Ø 150 mm)
- movable suction cups for adaptation to the windshield bulge
- frame dimensions: 1310 x 280 mm
- suction cup diameter: 150 mm
- max. weight of windshield: 80 kg
- aluminum frame



Item #
8817

Windshield Holder

- tubular steel construction
- ideal for storing windshield while removing or applying adhesive material etc.
- foldable to save space during storage
- soft wrapped upper frame for secure holding of windscreen
- frame width: 1005 mm
- frame depth: 570 to 800 mm
- frame height: 600 to 900 mm (depending on the setting of frame depth)
- max. capacity: 50 kg



Item #
8380

Windshield Holder | with Suction Pads

- ideal for storing windshield while removing or applying adhesive material etc.
- for front and rear windows, side windows and others
- foldable to save space during storage
- 4 suction pads for secure holding of windscreen (Ø 130 mm)
- max. load: 25 kg
- height: 950 mm
- support point distance: 710 x 620 mm



Item #
8460

Suction Lifter Set | 3 pcs.

- incl. ratchet strap
- 2 twin suction lifters (BGS 8000) and ratchet strap
- for easy transport, assembly and removal of windscreen and rear window
- max. load per twin suction lifter: 60 kg



Item #
7997



Rubber Suction Lifter | extra strong | Ø 200 mm

- with sturdy handle
- for lifting, carrying and holding
- with release button
- diameter: 200 mm
- max. rated load capacity: 80 kg



Item #
7983

Triple Rubber Suction | aluminium | Ø 115 mm

- is required for lifting and mounting of windshields
- max. rated load capacity 95 kg
- suction cup diameter: 115 mm
- toggle lever suction device



Item #
7996

Double Rubber Suction | aluminium | Ø 115 mm

- is required for lifting and mounting of windshields
- max. rated load capacity 80 kg
- suction cup diameter: 115 mm
- toggle lever suction device



Item #
7993

Twin Suction Lifters | ABS | with flexible Heads | Ø 120 mm | 390 mm

- with quick release lever
- with recess for ratchet strap
- length: 390 mm
- diameter: 120 mm
- max. rated load capacity: 70 kg



Item #
8000



Rubber Twin Suction Lifter | ABS | Ø 120 mm | 325 mm

- fixed cups for flat windows
- with quick release lever
- diameter: 120 mm
- max. rated load capacity: 60 kg



Item #
7991

Suction Lifter | Metal | Ø 115 mm

- with quick release lever
- diameter: 115 mm
- max. rated load capacity: for up to 45 kg



Item #
7995

Rubber Suction Lifter | ABS | Ø 115 mm

- with quick release lever
- ideal for lifting windows, body repair, etc.
- diameter: 115 mm
- max. rated load capacity: 40 kg

Item #
7998



Rubber Suction Lifter | ABS | Ø 55 mm

- with quick release lever
- ideal for removing little body dents etc.
- diameter: 55 mm
- max. rated load capacity: 5 kg

Item #
7987



Denting Iron Set | 23 pcs.

- suitable for removing dents
- includes irons with round, flat, point and ball heads
- made of 5 to 14 mm round stainless steel
- 45° up to 135° bent heads
- length: 250 mm to 1150 mm
- PVC dipped handles
- in aluminium transport case
- with strip holders for denting irons

Item #	Description
1642	Denting Iron Set 23 pcs.
1642-LEER	Aluminium empty Case for BGS 1642

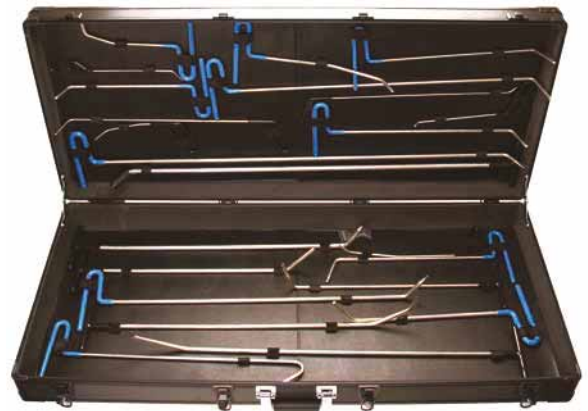

Denting Iron Set | 30 pcs.

- suitable for removing dents, ideal even with hail damage
- allows repair of dents without painting
- no need to disassemble car body parts
- disassembly of panels is rarely necessary
- repair costs can be kept low, no painting cost
- set consists of all bumping tools needed in various lengths and shapes
- made of stainless and carbon steel
- also contains air inflating pillow, trim strip wedge and other parts



Item #
1639

Denting Iron Set | 8 pcs.

- for the removal of dents in a car's body without damaging the finish
- ideal for removing small dents and damaging caused by hail
- made of stainless steel
- various head forms
- delivered in a handy carrying case
- 2 half-round bars 210 / 220 mm
- 1 round bar 420 mm
- 1 half-round pointed bar 600 mm
- 2 angled ball-headed bars 460 / 1000 mm, plastic head with M5 x 0.81 thread
- 1 pointed bar 500 mm
- 1 special-type hooked bar 1070 mm

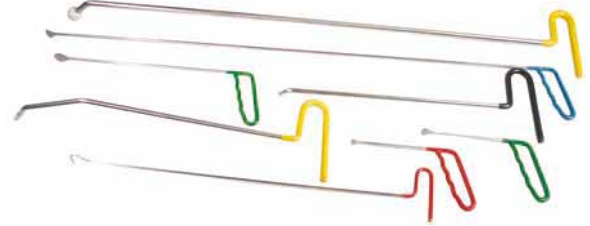

Item #	Description
1659	Denting Iron Set 8 pcs.
1659-KÖPFE	Plastic Replacement Heads for Denting Iron Set M5 x 0.8 mm for BGS 1659 3 pcs.
1659-LEER	Bag for BGS 1659 blue

Vacuum Body Repair Set with Sliding Hammer (with hand Pump)

- when using the pump the hammer creates a vacuum and causes the vacuum pad to hold firmly on to the body and dents can now easily be removed by working the sliding hammer
- no air compressor needed
- 3 replaceable strainers: Ø 70 mm, Ø 100 mm, Ø 125 mm
- Slide hammer weight: 1100 g



Item #
8703

Pro Dent Repair Set

- suitable for repair of minor dents
- painting and filling work are unnecessary
- no colour differences
- reduces time and cost
- 9 dent pads in various sizes and shapes
- special adhesive glue sticks with very good performance
- sliding hammer for pulling out hard dents
- pulling unit with rubberized feet for slight dents on flat surfaces
- plastic scraper for gentle removal of dent pads

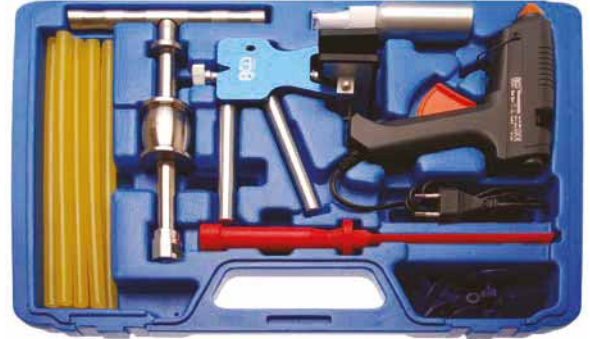

CE

Item #	Description
865	Pro Dent Repair Set
867	Spare Glue Stick for BGS 865, 8057 10 pcs.
865-1	Extractor for BGS 865
865-2	Spray Bottle for BGS 865
865-3	Sliding Hammer for BGS 865

Dent Repair Pads | for BGS 865 | 12 pcs.

- suitable for BGS 865
- also suitable for BGS 865-6 and 865-7

includes the following pads:

- round, adhesive surface convex: Ø 15 - 20 - 25 mm
- round, adhesive surface straight: Ø 32 - 36 - 42 mm
- oval, adhesive surface straight: 23 x 34 - 28 x 41 - 33 x 48 mm
- rectangle, adhesive surface straight: 20 x 30 - 23 x 35 - 32 x 49 mm

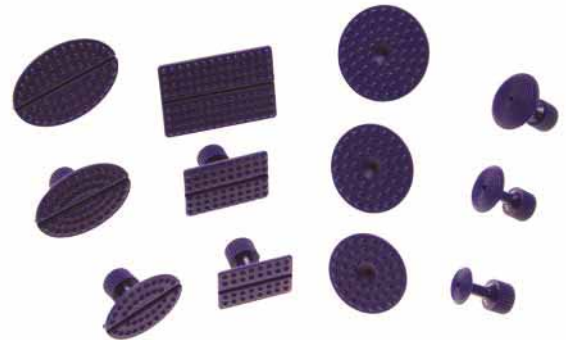

Item #
874

Dent Repair Handle

- to removing dents
- suitable for dent repair pads BGS 874



Item #
865-7

Dent Repair Sliding Hammer Set

- 460 mm sliding hammer with adaptor head for pads,
- sliding hammer weight: 180 g
- adaptor head thread: M12 x 1.75
- material: aluminum, anodised

includes the following pads:

- round, adhesive surface convex: Ø 15 - 20 - 25 mm
- round, adhesive surface straight: Ø 32 - 36 - 42 mm
- oval, adhesive surface straight: 23 x 34 - 28 x 41 - 33 x 48 mm
- rectangle, adhesive surface straight: 20 x 30 - 23 x 35 - 32 x 49 mm



Item #
865-6

Dent Removal Pen

- for pushing out small dents, e.g. hail damage, etc.
- made of plastic, front rounded

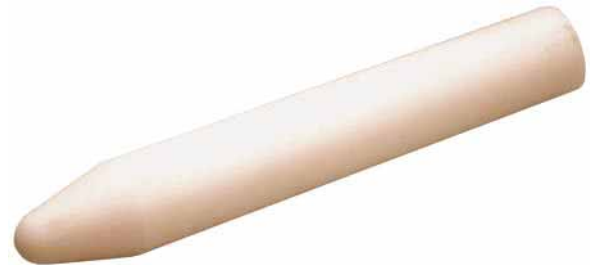

Item #
8684

Dent Repair Set | 12 pcs.

- for pushing out small dents, e.g. hail damage, etc.
- 2 Retainer plates 155 mm long
- 1 aluminium handle 90 mm long
- 1 aluminium handle 130 mm long
- with following interchangeable heads:
 - 1 cylinder form Ø 16 mm, 56 mm long
 - 1 cylinder form, tapered, Ø 6 mm, 56 mm long
 - 1 wedge shape, round, 8 x 16 mm, 56 mm long
 - 1 wedge shape, square, 8 x 16 mm, 56 mm long
 - 1 wedge shape, round, 4 x 16 mm, 56 mm long
 - 1 wedge shape, square, 4 x 16 mm, 56 mm long
 - 1 conical, sharp, 56 mm long
 - 1 conical, round, 56 mm long
- material: plastic



Item #
9411

Hook Set for Dent Repair Rods | 10 pcs.

- for supporting of dent rods
- can be used with BGS 1639, 1642 and 1659
- material: stainless steel



Item #
8713

Aluminium Dent Removal Pen with replaceable Tips | 100 mm

- for painless dent repair
- with 4 exchangeable tips
- length can be reduced to 70 mm using the spacer



Item #
9155



Silicon Water Remover | 300 mm

- for removing of water on all even surfaces, such as windshields
- soft silicone, very gentle to surfaces
- width: 300 mm



Item #
8855



Body-Edge Protection | magnetic | 2 pcs.

- for body edge protection during polishing or lacquering
- with magnetic base to ensures easy handling
- dimensions: 153 x 88 mm
- includes 2 pieces
- material: polypropylene (PP)

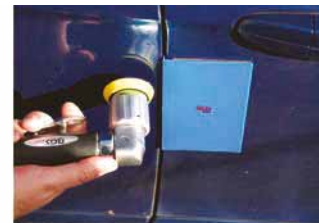

Item #
8508



Fixing Plate for Smart Repair / bump reflector | white | with lighting

- indispensable tool for paintless dent removal
- ideal for detecting dents and bumps, for example after hail damage
- Projecting of strips onto the paint to easily locate bumps
- 3 lines of aluminium, SMD LED strips, light colour: 6200K
- black & white striped lens cover (270 x 155 mm)
- anodized aluminium shield
- with suction cup and articulated arm (gooseneck / individually adjustable) for trouble-free use on the vehicle
- power supply: 12 V (cigarette lighter)
- cable length: 5 m



Item #
9147



Reflectorboard for Smart Repair | yellow

- board size 200 x 240 mm
- 350 mm articulated arm with 70 mm suction cup



Item #
865-4

Reflectorboard for Smart Repair | white

- board size 200 x 240 mm
- 350 mm articulated arm with 70 mm suction cup

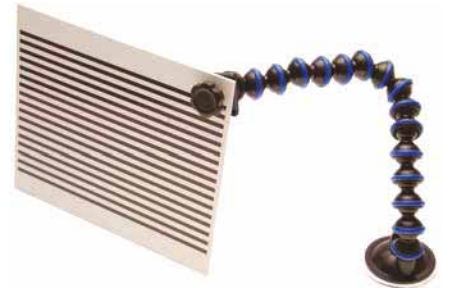

Item #
865-5

Dent Mirror | Ø 800 mm

- ideal for better identification of dents and bumps, e.g. hail damage, stone-chipping or small parking damages
- asymmetric lines for precise detection of minor deformations
- suitable for mobile use, folds in seconds
- in practical storage pouch Ø 300 mm
- with plastic handle



Item #
9597

Door Hinge Mounting Tool Set

- for disassembly and assembly of door hinges, also suitable for other work in tight spaces
- includes the following bits with retaining ball and hexagon drive: for Spline screws M8, M10 and M12, as well as for T-Star screws T30, T40, T45 and T50
- offset bit wrench with 2 different heads
- reversible ratchet



Item #
8415



Door Hinge Tool Set | 8 pcs.

- especially assorted for working on VW/Mercedes-Benz/ Porsche/Audi door hinges:
- 1 Screwdriver T30 (length 360 mm)
- 1 T-handle Screwdriver T 20 (length 240 mm)
- 1 reversible bit ratchet (length 240 mm)
- 5 bits T-Star T40 - T45, spline M4 - M8 - M10



Item #
3539



Door Adjusting Lever

- for adjusting the side door gap dimensions of passenger cars, vans and trunk lids of hatchback cars
- is locked for adjusting on the lock pin and the door lock trap
- incl. locking pins in different sizes (storage space in handle)
- material: special steel
- surface finish: chrome-plated



Item #
3548

Door Adjusting Tool | 660 mm

- for cars and small trucks
- length: 660 mm



Item #
3538

Door Pin Removing Tool | 370 mm

- for the installation and extension of car door pins
- extra heavy duty finish, 16 mm
- this tool guarantees a quick and secure assembly of car doors
- impactors available under BGS 1801
- length: 370 mm

Item #
1800



Door Pin | 5 x 115 mm

- for door pin removal tool BGS 1800

Item #
1801



Door Handle Clip Pliers | 220 mm

- allows you to remove the window crank clips
- prevents damage to the door panel
- anti-slip coated handle
- riveted jaws
- Handle dip insulated
- length: 220 mm

Item #
3542

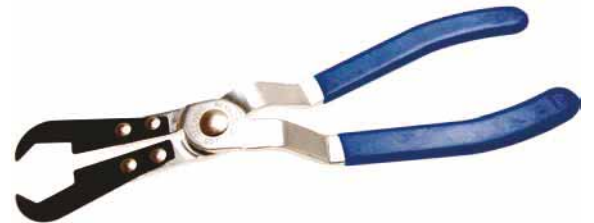

Window Lift and Door Handle Clip Removing Tool | 270 mm

- hardened
- prevents damaging the door trim

Item #
3543



Emergency Car Opening Set

- sold only to authorised workshops
- universally applicable
- heavy duty modelPacked in a wallet

Item #
3546



Air Inflating Pillow Set | 5 pcs.

- for damage-free spreading e. g. door frames for emergency opening
- hand pump with valve
- consisting of:
 - 1 pad, kidney shape, dimensions: 320 x 150 mm
 - 1 pad 190 x 60 mm
 - 1 pad 160 x 40 mm
 - 1 pad 160 x 160 mm
 - 1 hand pump with hose length: 350 mm

Item #
3547



Air Inflating Pillow

- for damage-free spreading e.g. door frames for emergency opening
- hand pump with valve
- 1 pad - thickness 2 mm (airless), 70 mm (inflated)
- 1 hand pump with hose length: 350 mm
- length: 160 mm
- width: 160 mm

Item #
3544



Door Handle Tool for Renault Megane, Scenic

- for removing/installation of the front door locking cylinder
- disassembly of the door panel is not necessary
- suitable for Renault Megane, Scenic, Fluence
- length: 165 mm

Item #
8816



Door Handle Dismantling Tool for VW

- for fast and simple loosening of the locking hook which is difficult to reach when removing door handles without a locking cylinder
- to be used as VW OEM T10389
- blade length: 170 mm

Item #
8910



Locking Clamp for Hood and Trunk Openers

- for locking hood and trunk openers when the gas springs are not working
- maximum opening width 10 mm



Item #
2790



Telescopic Support Rod | 1100 - 1800 mm

- for supporting of the luggage compartment lid, lower engine covers, exhaust pipes, etc.
- telescopic steel tube with quick-action lock
- tiltable support plate with rubber pad
- with quick release for easy removal
- with 2 replaceable support heads
- max. load capacity: 37 kg
- length: 1100 - 1180 mm



Item #
9333

Telescopic Stand for Engine or Trunk Lid

- adjustable from 530 to 1200 mm
- for easy alignment of trunk lid and hood
- can be locked in many positions by turning the telescopic rods
- only a few centimetres more opening width can make working more convenient
- also useful when changing the original openers or dampers and during car body repair jobs
- rubber feet on both ends prevent slipping away
- low weight, made from aluminium



Item #
8246



Claw Socket for Mercedes Ignition Lock Rosette

- for dismantling of ignition locks
- to be used as OEM 210589000700
- suitable for Mercedes-Benz: W129, W140, W202, W210, W220, W203, W209, W211, W204



Item #
62675



Wiper Arm Puller Set | universal | 13 pcs.

- universally applicable
- with sliding hammer and ejection arbor
- 2-arm gear puller, suitable for following cars: Audi, BMW, Chrysler-Jeep, Citroen, Fiat, Ford, Honda, Hyundai, KIA, Land Rover, Mazda, MG-Rover, Nissan, Peugeot, Porsche, VW, MAN, MB, Scania
- allows trouble free disassembly of all current wiper arms
- perfect on rusty and stuck wiper arms
- helps protect nozzles inside the wiper arm by using the sliding hammer
- 1 x 2 arm puller
- 1 sliding hammer
- 1 pressure spindle
- socket 1: for Alfa-Romeo, Audi, BMW, Citroen, Fiat, Ford, Honda, Jaguar, Mazda, MG-Rover, MB, Mitsubishi, Opel, Peugeot, Renault, Seat, Skoda, Volvo, VW, Mercedes-Benz
- socket 2 fits Alfa-Romeo, Audi, BMW, Citroen, Fiat, Ford, Honda, Hyundai, Jaguar, Land Rover, MB, Opel Peugeot, Renault, Saab, VW, Mercedes-Benz
- socket 3: for Alfa-Romeo, Audi, BMW, Fiat, Citroen, Ford, Mazda, MB, Mitsubishi, Opel, Peugeot, Smart, Volvo, VW
- socket 4: for Citroen, Hyundai, MB, Opel, Mercedes-Benz
- socket 5: for Alfa-Romeo, Audi, BMW, Jaguar, Land Rover, Mazda, MB, Volvo, VW
- socket 6: for Citroen, Ford, Peugeot
- socket 7: for Audi, BMW, Land Rover
- socket 8: for Audi, BMW, Citroen, Chevrolet, Daewoo, Daihatsu, Fiat, Ford, Land Rover, Mazda, MB, Mitsubishi, Porsche, Skoda, Smart, Suzuki, Toyota, Volvo, VW

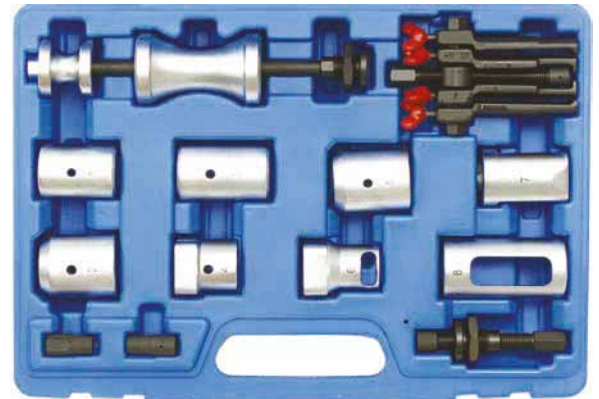

Item #	Description
65700	Wiper Arm Puller Set universal 13 pcs.
65700-1	Windscreen Wiper Arm Puller from BGS 65700 universal 15 - 55 mm

Front Wiper Repair Kit | for VW Golf IV, Audi A3, Seat, Skoda

- for repairing rusted wiper arm shafts
- replacement of wiper arm mechanism is not required
- saves repair costs

Item #
8631



Rear Window Washer Repair Kit | for VAG

- minimizes repair coast and allows professional drilling out of nozzle residues from the wiper arm shaft and of brass pipe out of wiper motors
- guide bushing for mounting on wiper axle
- 3 drills, of which 2 with guide holders
- 10 plastic pipes as brass pipe replacement
- suitable for the following VAG models: VW Golf IV, Passat, Sharan, Audi A4, Ford Galaxy, Seat Alhambra

Item #
8632



Windscreen Wiper Arm Puller | 26.5 mm | for Audi Q7

- allows easy and gentle dismantling of the wiper arms
- opening size: 26.5 mm

Item #
7792



Windscreen Wiper Arm Puller | 15 mm | for Audi

- suitable for Audi A3, A4, A5, A6
- allows easy and gentle dismantling of the wiper arms
- opening size: 15 mm

Item #
7793



Windscreen Wiper Arm Puller | for Honda, Opel, VW

- suitable for VW Lupo and Polo, Opel Astra G, Zaphira B, Corsa C, Vectra C, Honda Jazz, CRV, FRV etc.
- allows easy and gentle dismantling of the wiper arms

Item #
7794



Windscreen Wiper Arm Puller | for BMW, VW

- suitable for BMW 5-series E39 and 7-series E38 up to 2005, VW Golf and Passat up to 2005
- allows easy and gentle dismantling of the wiper arms
- puller depth 32 mm
- claw opening: 24 mm

Item #
7795



Windscreen Wiper Arm Puller | 16 mm

- for removing the windshield wiper arms

Item #
9974



Pole Terminal and Wiper Arm Puller | 2-arm

- adjustable and suitable for most car and truck types



Item #
7743



Windscreen Wiper Arm Puller | for Ford, Mercedes-Benz, Seat

- suitable for Ford Galaxy, Seat Alhambra Mercedes A and B classes as of 2005, VW / Audi with internal wiper nozzle
- allows easy and gentle dismantling of the wiper arms
- with brass tip for ejection tool
- puller depth 45 mm



Item #
7796



Windscreen Wiper Arm Puller | for Porsche, VW

- suitable for: VW Touareg, Porsche Cayenne and other SUVs, Ford Galaxy, Seat Alhambra
- allows easy and gentle dismantling of the wiper arms
- max. puller width 60 mm
- puller depth 43 mm



Item #
7797

Wiper Arm Puller for Rear Window Wiper, VAG

- especially for removal of VAG rear wiper arms



Item #
9967



Windscreen Wiper Arm Puller | universal

- for removing of front and rear wiper arms
- brass pressure sleeve prevents damage to the thread
- 360° rotatable puller arms
- handwheel, no additional tool required
- chrome-plated base, press sleeve brass made hardened spindle



Item #
7798



Windscreen Wiper arm pullers

- prevents damage to the bodywork and the windscreen wiper arm
- fine thread
- height 85 mm
- fits BMW



Item #	Description
9965	Windscreen Wiper Arm Puller 15 mm for BMW
9965-1	Brass Pressure Piece for BGS 9965

Windscreen Wiper Arm Puller | 15 - 30 mm | for BMW

- suitable for e.g. following BMW models: E12 - E21 - E23 - E24 - E28 - E30 - E30C - E31 - E32 - E32/3 - E34 - E36 - E36/2 - E36/3 - E36/5 - E36/7 - E36/C - E38 - E38/3 - E39 - E39PL - E46 - E46/16 - E46/2 - E46/3 - E46/5 - E46/C - E52 - E53 - E60 - E65 - E66 - E67 - E85
- adjustable puller claw opening

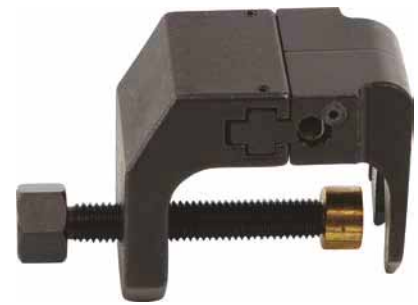

Item #
9966

Windscreen Cleaning Nozzle Adjusting Tool | for Opel

- for adjusting the nozzles at the front windscreen
- suitable for e.g. Opel Astra J (as of 2010), Insignia (as of 2009)



Item #
9148



Windshield Wiper Adjustment Tool

- for checking / adjusting the angle between the windshield wiper arm and the windshield
- suitable for all hook style wiper arms (not suitable for new aero style arms)
- to be mounted at the front of the wiper arm and the angle can be adjusted with a wrench
- Measuring range: ± 15 degrees
- to be used as VAG OEM 3358A, for example



Item #
9419



Trim Strip Wedge / Scraper Set | 27 pcs.

- for removal of trim, paneling, etc.
- allows a damage-free disassembly, even on painted surfaces
- wide range of application through different scraper and removal tool profiles, such as:
 - scraper with trim guide
 - slotted lever, angled and straight
 - disassembly lever, angled and straight, in different widths

Item #
8611



Car Interior Lining Set | 11 pcs.

- various plastic levers for a safe and reliable assembly and disassembly of car lining, plastic clips, rear view mirrors etc.
- especially designed for narrow and hard to reach working conditions
- fibreglass reinforced plastic
- in plastic bag

Item #
1327



Assembly Wedge Set | 5 pcs.

- made from special hard plastic / nylon
- for working on car interior lining, cover panel, dashboard, trim strips

Item #
63250



Trim Strip Set | various Shapes | 5 pcs.

- manufactured from high end special plastic
- various shapes for working on trim strips, rubber gaskets, interior, door trims, switches, etc.
- length: 160 - 200 mm

Item #
3027



Special Clip Remover Set | 5 pcs.

- slip guard handles
- U-Notch Chisel (internal 8.2 mm / external 31.5 mm)
- V-Notch Chisel 38 mm (internal 4-12.5 mm / external 31.5 mm)
- U-Notch Chisel 13 mm (internal 6.15 mm / external 12.8 mm)
- V-Notch Chisel 13 mm (internal 1-4.4 mm / external 12.8 mm)
- U-Notch Chisel 38 mm, long bended type (internal 8.4 mm / external 31.4 mm)



Item #
1328



Interior Lining and Clip Removal Tool Set

- for fast and easy dismantling of car interior linings
- adapts to versatile applications because of 3 different sizes (4, 8 and 10 mm)
- and two different lengths (235 mm and 495 mm)
- ergonomic handle
- with hanging hole



Item #
1326

Plastic Chisel Set 6 pcs.

- suitable for removing of e.g. panels, glued trim parts and wheel weights
- made of plastic, prevents damage
- blue chisels are flexible and suitable for softer work
- black chisels are stiffer and suitable for tougher work
- handle end is designed to be used with a hammer
- 1 flathead chisels 175 mm, blue
- 1 flathead chisels 175 mm, black
- 1 round head chisels 127 mm, blue
- 1 round head chisels 127 mm, black
- 1 flathead chisels 127 mm, blue
- 1 flathead chisels 127 mm, black



Item #
368



Edge Protection and Sealing Rubber Loosener

- for easy disassembling of door seals and edge protection rubber
- made of 1 mm strong, inelastic steel sheet, with dip coated handle
- 180° folded, 18 mm grip edge, width: 57 mm
- length: 190 mm
- width: 130 mm



Item #
1330



Panel Removal Wedge Set for VW | 3 pcs.

- for dismantling e.g. door panels, under-seat drawers, etc.
- suitable for VW EOS, Polo, Passat, etc.
- to be used as VW OEM: T10383 - T10383/1 - T10383/2



Item #
8920

Trim Strip Wedge with Hole | 100 x 45 mm

- for damage-free removal of trim strips
- length: 100 mm
- width: 45 mm
- material: plastic
- **BGS 3029**
 - length: 185 mm
 - width: 25 mm
- **BGS 3032**
 - length: 100 mm
 - width: 45 mm



Item #	Description
3029	Trim Strip Wedge with Hole 100 x 45 mm
3032	Trim Strip Wedge 185 x 25 mm

Doorclip / Rivet Pliers | 230 mm

- revolving head 0 - 90°
- for opening and/or loosening two-piece rivets (plastic clips on motorcar doors and car body components)



Item #
3545



Panel Clip Pliers | 190 mm

- for removing body clips
- with 35° offset head, specifically for hard on reach places
- suitable for common clips at newer vehicle models such as Honda, Toyota, GM, Ford, etc.
- spring loaded opening mechanism for ease of use
- made of heat treated steel
- PVC dipped handles



Item #	
8934	

Door Trim Pliers

- for loosening plastic clips on door trims, bumper straps, etc.
- black finish jaw manufactured from hardened sheet steel
- also suitable for the release of bumper rubber etc.



Item #	
3192	

Door Trim Removing Tool | 245 mm

- for removal of trim strips on car bodies
- can be used for nearly all brands
- Slot width 7.5 mm
- Slot length 13 mm
- opening size: 7.5 mm



Item #	
3092	

Door Trim Removing Tool

- for removal of trim strips on car bodies
- can be used for nearly all brands
- **BGS 3104**
 - slot width: 7 mm
 - slot length: 10 mm
 - opening size: 16 mm
 - length: 235 mm
- **BGS 3193**
 - slot width: 6 mm
 - slot length: 13 mm
 - opening size: 19 mm
 - length: 240 mm



Item #	Description
3104	Door Trim Removing Tool 235 mm
3193	Door Trim Removing Tool 240 mm

Hook Set | 4 pcs.

- is needed for e.g. laying of cables, cushions, etc.
- all hooks with tip
- piercer (straight), hook 90° angled, hook with round head, double angled hook
- 2-Komponenten-Griff

Item #
8451



Assembly Tool Set | 220 mm | 2 pcs.

- straight and bent (45° and 90°) tips
- length: 220 mm

Item #
8015



O-Ring Hook Set | 5 pcs.

- incl. magnetic pick up tool

Item #
8035



Assembly Hook

- for brake spring and headlight spring assembly
- material: steel, alloyed
- surface finish: black

Item #
8018



Interior Cladding Hooks | universal

- especially useful for stuck linings
- T-handle for easy pulling
- offset head with 9 mm opening
- by 485 mm length also suitable for deep-seated fastenings
- universally applicable for all types

Item #
8285



Seal Removing Hook Set | 3 pcs.

- S-shaped hooks e. g. for loosening rotary shaft seals
- 90° hooks e. g. for loosening O-rings
- small hook tool



Item #
8405



Hook Set for Disassembly of Mercedes Dashboards | 2 pcs.

- suitable for many Mercedes Benz models: W107, W116, W123, W124, W126, W140 and W210
- for easy removal of the instrument panel
- made from stainless steel

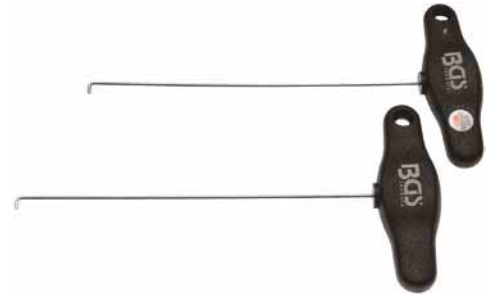

Item #
69510

Pipe Wrench | for Mercedes-Benz W204 bumpers | 6.3 mm (1/4")

6.3 mm 1/4"

- 10 mm hexagon pipe wrench
- length: 160 mm
- surface finish: chrome-plated



Item #
8479

Lead Perlon Cable | 15 m x 3 mm

- for installing antenna cables etc.



Item #
1990



Air Conditioner Tool Set

- contains all tools for fittings on air conditioning systems
- a useful supplement for BGS 8036
- special sockets for 2.2 and 3.2 mm fixed throttles
- 2 special 8-pt. sockets 12 and 15 mm, 6.3 mm (1/4") drive
- bits for loosening e.g. TS-star flanges (for Torx Plus): TS10, TS15, TS20, TS25, TS27, TS30 and TS40

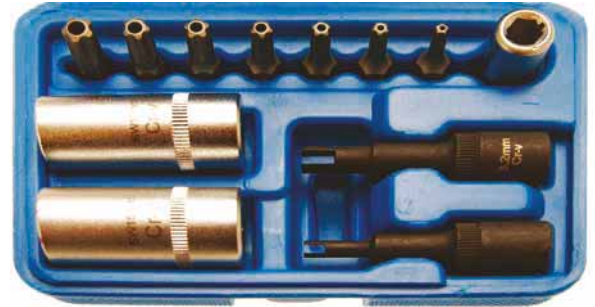

Item #
2275



Sliding Hammer for Air Conditioner Dryer Units

- allows easy disassembly of the dryer housing cap
- is required during renewing of the dryer cartridge
- suitable for cover with M5 female thread



Item #
9061

Radiator Pressure and Cooling System Tester | Refilling System included | 28 pcs.

- suitable for all standard vehicles
- measuring range: 0 - 2.5 bar
- same parts as in BGS 8027 and additionally adaptors for following cars:
 - Mercedes-Benz A-class
 - BMW E60, E63, E64, E65
 - VW Sharan 1.8, 2.8
 - Toyota RAV 4, Previa
- also contains an additional alternator maintenance kit for cleaning the alternator and refilling cooling liquid



Item #	Description
8098	Radiator Pressure and Cooling System Tester Refilling System included 28 pcs.
8098-1	Cooling System Charger
8098-2	Rubber Adaptor for BGS 8098
8098-3	Replacement Hose for BGS 8098
8098-20	Adaptor 20 for BGS 8027, 8098 for Saab Ecopower
8098-21	Adaptor 21 for BGS 8027, 8098 for Fiat, Opel, Saab
8098-22	Adaptor 22 for BGS 8027, 8098 for BMW
8098-LEER	Empty Case for BGS 8098

Radiator Pressure and Cooling System Tester, Refilling System included | 18 pcs.

- suitable for all standard vehicles
- measuring range: 0 - 2.5 bar, accuracy +/- 2 %
- contents as per table below

Item #	Description
8027	Radiator Pressure and Cooling System Tester 18 pcs.
8027-LEER	Empty Case for BGS 8027
8027-1	Pump for BGS 8027, 8098
8027-2	Thermometer for BGS 8027, 8098
8027-3	Adaptor No. 3 for BGS 8027, 8098 for Buick, Chevrolet, Chrysler, Dodge, Jeep, Mercedes-Benz, Oldsmobile, Pontiac
8027-4	Adaptor No. 4 for BGS 8027, 8098 for Ford, Honda, Hyundai, Lexus, Mazda, Mercedes-Benz, Mitsubishi, Nissan, Peugeot, Subaru, Suzuki, Toyota
8027-5	Adaptor No. 5 for BGS 8027, 8098 for Acura, Chevrolet, Dodge, Eagle, Honda, Isuzu, Lexus, Mercedes-Benz, Mitsubishi, Suzuki, Toyota
8027-6	Adaptor No. 6 for BGS 8027, 8098 for Daewoo, Ford, Jaguar, Jeep, Land Rover, Mercedes-Benz, Pontiac, Porsche, Saab
8027-7	Adaptor No. 7 for BGS 8027, 8098 for Alfa Romeo, Citroën, Fiat, Mini, Peugeot, Renault, Saab
8027-8	Adaptor No. 8 for BGS 8027, 8098 for VW
8027-9	Adaptor No. 9 for BGS 8027, 8098 for Audi, BMW, Porsche, VW
8027-10	Adaptor No. 10 for BGS 8027, 8098 for BMW
8027-11	Adaptor No. 11 for BGS 8027, 8098 for Audi, VW
8027-12	Adaptor No. 12 for BGS 8027, 8098 for Ford Mondeo, Land Rover, Opel, Ssangyong
8027-13	Adaptor No. 13 for BGS 8027, 8098 for Chrysler, Mercedes-Benz
8027-14	Adaptor No. 14 for BGS 8027, 8098 for Ford
8027-15	Adaptor No. 15 for BGS 8027, 8098 for Ford, Mazda
8027-16	Adaptor No. 16 for BGS 8027, 8098 for Mercedes-Benz
8027-17	Adaptor No. 17 for BGS 8027, 8098 for BMW
8027-18	Adaptor No. 18 for BGS 8027, 8098 for VW
8027-19	Adaptor No. 19 for BGS 8027, 8098 for Toyota
8027-30	Connector R123, R124 for BGS 8027, 8098 black
8027-31	Connector R123/R125 for BGS 8027, 8098 blue
8027-32	Plastic Wrench for BGS 8027, 8098
8027-33	Hose for Item 8027, 8098



Cooling System / Heating / Air Conditioning

Cooling System Bleeding and Filling Tool | 6 pcs.

- for the straight forward bubble-free filling of coolant systems, at the same time testing for leaks by negative pressure
- universal version with quick-action coupling
- gauge with rubber protection (accuracy +/- 2 %)
- rubber head adjusts to nearly all car types
- cone adaptor diameter: 15 to 44 mm

Item #	Description
1773	Cooling System Bleeding and Filling Tool 6 pcs.
1773-3	Test Adaptor with Dial Gauge for BGS 1773



Cooling System Bleeding and Filling Tool | 6 pcs.

- for simple refilling and bleeding of cooling systems by negative pressure
- safe filling of all hollow space
- allows a vacuum tightness test on the cooling system
- with adaptor for most car types
- suitable for most radiators / expansion tanks
- 1 main device
- 1 filling valve
- 1 extension hose
- 1 cone adaptor
- 2 expansion cones



Item #
9502

Universal Radiator Test Set | 5 pcs.

- for pressure tests of cooling systems to find leakages
- 4 expanding cone adaptors, no additional expensive adaptors needed
- suitable for most vehicles
- dimensions of the cone adaptors min. / max.:
 - 17 mm - 24,0 mm
 - 28 mm - 31,5 mm
 - 37 mm - 39,5 mm
 - 47 mm - 48,5 mm
- pump with colour-coded gauge 0 - 2.4 bar (0 - 35 psi), quick coupler and pressure release valve



Item #
8096

Universal Cooling System Test Adapter

- for quick adaptation
- spreading rubber suitable for 30 - 35 mm openings
- including 3 rubber adapter rings for 35-40, 40-45, and 45-50 mm openings
- fits on BGS 8027, 8027-1 and 8098
- made of anodised aluminium

Item #	Description
8599	Universal Cooling System Test Adapter 30 - 50 mm
8599-1	Rubber for Universal Cooling System Test Adapter 35 - 40 mm
8599-2	Rubber for Universal Cooling System Test Adapter 40 - 45 mm
8599-3	Rubber for Universal Cooling System Test Adapter 45 - 50 mm



Universal Coolant Filling Set | 7 pcs.

- quick, clean and easy way to fill cooling system during the bleeding process
- versatile, suitable for many reservoir types
- with shut-off valve
- adaptor Ø 31 - 35 - 40 and 45 mm



Item #
8627

Refractometer

- optical tester with various functions:
 - testing of density of battery acid: 1.1 to 1.4 kg/l
 - testing of coolant water anti-freeze (subdivides into ethylene and propylene): 0 ° to -50 ° C
 - testing ethanol and alcohol-based (SRF1) screen washer fluids: 0 ° to -40 ° C
 - testing urea AdBlue® (AUS32)
- adjustable ocular
- precision +/- 5 %
- in storage box
- refractometer
- pipette
- adjustment screwdriver
- microfibre cloth



Item #	Description
1824	Refractometer
1824-1	Replacement Flap for Refractometer from BGS 1824

Exhaust Pipe Expander Set | 3 pcs.

- for expanding of previously heated pipes
- allows the installation of new exhaust pipes on old exhaust parts
- expander 1, spreading width range from 31 to 44 mm
- expander 2, spreading width range from 39 to 61 mm
- expander 3, spreading width range from 54 to 87 mm



Item #	Description
129	Exhaust Pipe Expander Set 3 pcs.
127	Exhaust Pipe Expander 31 - 44 mm
120	Exhaust Pipe Expander 39 - 61 mm
128	Exhaust Pipe Expander 54 - 87 mm

Ratcheting Tube Cutter for Exhaust Pipes | 28 - 67 mm

- fits pipes Ø 28 - 67 mm
- cutting depth 3 mm
- ratchet has 60 teeth, 6° between each click



Item #	Description
66250	Ratcheting Tube Cutter for Exhaust Pipes 28 - 67 mm
66251	Replacement Axle for Cutting Wheel for BGS 66250
66255	Standard cutting wheel for BGS 66250
66250-1	Stainless Steel Cutting Wheel for BGS 66250

Chain Pipe Cutter | 250 mm

- for cutting tubes made of steel, copper, PVC and aluminum up to a diameter of about 85 mm
- re-adjustable during cutting action via butterfly nut
- chain length: 250 mm



Item #	Description
134	Chain Pipe Cutter with HSS Chain 250 mm
130	Spare Chain for Pipe Cutter BGS 134
133	Chain Pipe Cutter 250 mm
133-Kette	Spare Chain for Pipe Cutter for BGS 133

Impact Oxygen Sensor Loosening Wrench

- for loosening of oxygen sensors
- suitable for e. g. air hammer BGS 3515
- 10 mm shank diameter
- suitable for oxygen sensors with hexagonal profile, 22 mm



Item #
8791

Oxygen Sensor Socket Set | 14 pcs.

12.5 \square 1/2

- oxygen sensor socket, 12,5 mm (1/2") drive, 30 mm, 12-point, length 80 mm: for Bosch, General motors, Mercedes-Benz
- oxygen sensor socket, 12,5 mm (1/2") drive, 27 mm, hexagon, length 80 mm: for all types of cars
- oxygen sensor socket, 12,5 mm (1/2") drive, 28 mm, 12-point, length 80 mm: for Volvo, Scania, HGV
- oxygen sensor socket, 12,5 mm (1/2") drive, 21 mm, 12-point, length 85 mm: for Ford, VAG
- oxygen sensor socket, 12,5 mm (1/2") drive, 27 mm, 12-point, length 85 mm: for BMW, Fiat, Ford, Peugeot
- oxygen sensor socket, 12,5 mm (1/2") drive, 22 mm, 12-point, length 80 mm: for all types of cars
- oxygen sensor socket, 12,5 mm (1/2") drive, 27 mm, 12-point, length 110 mm: for PSA
- oxygen sensor socket, 12,5 mm (1/2") drive, 22 mm, 12-point, length 110 mm: for Audi, BMW, Mercedes-Benz, VW, Volvo
- oxygen sensor socket, 12,5 mm (1/2") drive, 22 mm, 12-point, length 150 mm: for BMW
- oxygen sensor socket, 12,5 mm (1/2") drive, 20 mm, hexagon, length 80 mm, slotted: for all types of cars
- oxygen sensor socket, 12,5 mm (1/2") drive, 19 mm, 12-point, length 80 mm: for VW, Audi, Seat
- oxygen sensor socket, 12,5 mm (1/2") drive, 17 mm, 12-point, length 80 mm: for BMW, Mercedes-Benz, Renault
- oxygen sensor socket, 12,5 mm (1/2") drive, 22 mm, 12-point, length 50 mm, offset drive: for all types of cars
- oxygen sensor socket, 10 mm (3/8") drive, 22 mm, hexagon, length 30 mm, offset drive: for all types of cars



Engine & Attachments

Item #
1149



Oxygen Sensor Socket Set | 7 pcs.

10 \square 3/8 12.5 \square 1/2

- for assembly of oxygen sensors, radiator thermo switches and diesel injection nozzles
- 29 x 90 mm, 12,5 mm (1/2") drive, slot 7 mm
- 22 x 90 mm, 10 mm (3/8") drive, slot 20 mm
- 22 x 74 mm, 10 mm (3/8") drive
- 27 x 78 mm 12-point, 12,5 mm (1/2") drive, window 28 mm
- 22 x 80 mm, 10 mm (3/8") drive, slot 9 mm
- 22 mm offset, 10 mm (3/8") drive, slot 8 mm
- 22 mm offset, 12,5 mm (1/2") double-4-point drive, slot 11 mm

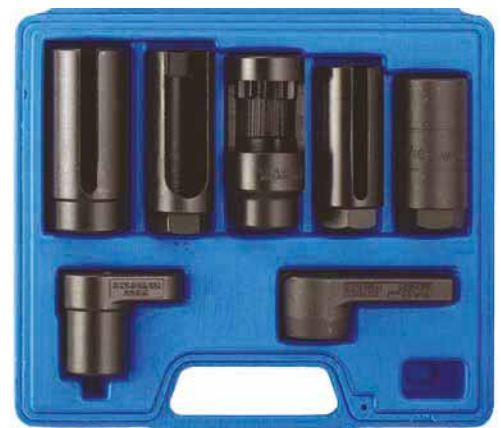

Item #	Description
1140	Oxygen Sensor Socket Set 7 pcs.
1140-22	Oxygen Sensor Socket angled 12.5 mm (1/2") double 4-point Drive 22 mm 11 mm slot
1140-27	Oxygen Sensor Socket 12.5 mm (1/2") Drive 27 mm 12-point, 28 mm window
1148	Oxygen Sensor Socket 10 mm (3/8") Drive 22 mm x 90 mm 20 mm slot
1140-LEER	Empty Case for BGS 1140

Oxygen Sensor Socket | 12.5 mm (1/2") Drive | 22 mm

12.5  1/2

- deep and slotted finish
- wrench size: 22 mm
- length: 90 mm



Socket for Oxygen Sensor | 10 mm (3/8") Drive | 22 mm

10  3/8

- wrench size: 22 mm



Oxygen Sensor Socket | 12.5 mm (1/2") Drive | 22 mm

12.5  1/2

- slot width 13 mm
- slot length 115 mm
- wrench size: 22 mm
- length: 150 mm
- outside diameter: 30 mm



Thermo Switch Socket | 12.5 mm (1/2") Drive | 29 mm

12.5  1/2

- extra deep, slotted finish
- socket size 29 mm for VW and Audi
- no damage of the thermo switch
- length: 78 mm
- surface finish: black burnished



Special Spanner for Exhaust Gas Temperature Sensor | 19 mm | for VAG | 3 pcs.

- for disassembly / assembly of exhaust gas temperature sensors
- suitable for e.g. following VAG engines: 1.8l TFSI - 2.0l TFSI - 2.0l FSI - 1.6l CRTdi - 2.0l Common Rail
- wrench size: 19 mm
- to be used as OEM T10395/8.../10

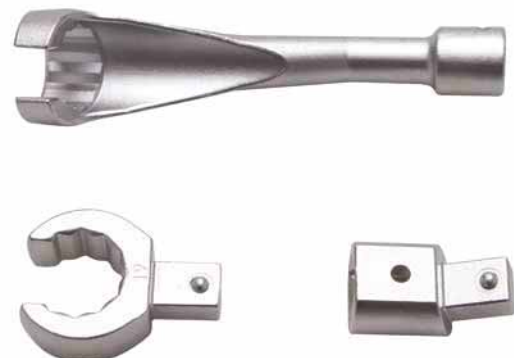
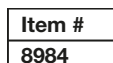

Exhaust Gas Recirculation Valve Disassembly Tool | for Hyundai and Kia

- for destruction-free dismantling of EGR / AGR valves
- sliding hammer with special claw
- suitable for Hyundai / KIA 2.0 & 2.2L diesel R engines installed in the Hyundai Tucson (as from 2009), ix35 (as from 2009), Santa Fe (as from 2009), Maxcruz (as from 2009) and KIA Sportage (R) (as from 2010), Sorento (R) (as from 2010), Carnival (as from 2010)



Item #
9472

Exhaust Pipe Spring Compressor | for VAG

- for VAG



Item #
1142



Exhaust Clamp Pliers | 305 mm

- for expanding of exhaust pipe clamps when changing the exhaust pipe
- suitable for: Citroen, Peugeot and Renault etc.
- 4 locking positions for easy working
- opening width: 20 - 60 mm



Item #
8250



Exhaust Pipe Hook

- for removing rubber straps on the exhaust system
- hook diameter: 6 mm
- length: 300 mm
- surface finish: chrome plated

Item #
121



Exhaust Rubber Hook Set | 2 pcs.

- for removing and mounting of exhaust rubbers
- dip coated T-handless

Item #
8440



Exhaust Pipe Rubber Ejection Pliers | 285 mm

- facilitates removal of rubber hangers
- 25° opening angle for easy operation

Item #
8256



Exhaust Pipe Rubber Ejection Pliers | 360 mm

- simplifies the removal of exhaust pipe rubbers
- heavy version
- especially suitable for vans and big cars
- with self-centering movable pin

Item #
8258



Diesel Injector Removal Kit | 10 pcs.

- for pulling out hard to remove diesel injectors
- to be used with optional sliding hammers BGS 7772-2, 7772, 7776
- 6 adaptors for installation in the injector thread:
 - inside thread M20x1.5 to inside thread M14x1.0
 - inside thread M20x1.5 to external screw thread M17x1.0
 - inside thread M20x1.5 to external screw thread M18x1.5
 - inside thread M20x1.5 to external screw thread M20x1.0
 - inside thread M20x1.5 to external screw thread M25x1.0
 - inside thread M20x1.5 to external screw thread M27x1.0
- 3 pulling claws with inside thread M18x1.5 and claw width 12, 13 and 16 mm
- ball head adaptor M18x1.5 to M18x1.5
- 10 mm internal hexagon bit socket with hole for the disassembly of the ring nut of the nozzle needle

Item #
7777



Injector Puller Hook

- for removing hard to remove injectors
- M18 x 1.5 female thread

- **BGS 7777-1**
 - jaw distance: 12 mm (inside)
 - jaw height: 17 mm
 - 75 mm inner distance between claw and the connection of the sliding hammer
- **BGS 7777-2**
 - jaw distance: 13 mm (inside)
 - jaw height: 15 mm
 - 96 mm inner distance between claw and the connection of the sliding hammer
- **BGS 7777-3**
 - jaw distance: 16 mm (inside)
 - jaw height: 15 mm
 - 96 mm inner distance between claw and the connection of the sliding hammer



Item #	Description
7777-1	Injector Puller Hook 12 mm
7777-2	Injector Puller Hook 13 mm
7777-3	Injector Puller Hook 16 mm

Ball Joint Adapter | M18 x 1.5

- suitable for following tools:
 - injector puller hook BGS 7777-1, 7777-2, 7777-3
 - universal puller BGS 7777-5
- internal screw thread M18 x 1.5 of external screw hook thread M18 x 1.5



Item #
7777-4

Pulling Hook, Heavy Duty Type, for Sliding Hammer | for BGS 7772, 7772-2, 7776

- for pulling out ball joints from the wheel bearing housing, straightening work on car bodies, etc.
- hook dimensions: approx. 170 x 140 x 30 mm
- M18 x 1.5 internal thread
- when using the slide hammer BGS 7772, 7772-2, 7776 the adaptor BGS 7771-1 (M18 x 1.5 outside to M20 x 1.5 inside) is required
- we recommend using the ball joint adapter BGS 7777-4



Item #
7777-5

Injector Removal Hook & Adaptor Set

- for easier removal of stubborn injectors with a sliding hammer
 - suitable for e. g., Common Rail injectors in the following vehicles:
 - Citroen C5 / Jumpy / Xsara, Opel, Renault F9Q
 - Fiat Ducato JTD
 - Peugeot 206 / 307 / 406 / Boxer (2.0 / 2.2 / 2.3 HDI)
 - Mercedes-Benz CDI (not A-class / Sprinter / Vito)
- 4 adaptors for attaching to the external injector thread
 - inner thread M25x0.50 to inner thread M18x1.5
 - inner thread M25x0.75 to inner thread M18x1.5
 - inner thread M27x1.00 to inner thread M18x1.5
 - inner thread M16x1.50 to inner thread M18x1.5
- 4 hooks for attaching to the injector body, claw width: 12 / 13,5 / 16 / 26 mm inner thread M18x1.5 for connecting a sliding hammer
- 1 sliding hammer adaptor, inner thread M20x1.5 to outer thread M18x1.5 for attaching the dismantling hooks & adaptors to BGS sliding hammers (BGS 7772, 7772-2, 7776)



Item #		
9457		

Injector Removal Kit | 6 pcs.

- for pulling out stuck common rail injectors
- adaptor inside thread M20 x 1.5 to inside thread M14 x 1.5
- adaptor inside thread M20 x 1.5 to external screw thread M17 x 1.0
- adaptor inside thread M20 x 1.5 to external screw thread M20 x 1.0
- adaptor inside thread M20 x 1.5 to external screw thread M25 x 1.0
- adaptor inside thread M20 x 1.5 to external screw thread M27 x 1.0
- 10 mm internal hexagon bit socket with hole for retaining ring of injector needle



Item #	Description
7771	Injector Removal Kit 6 pcs.
7771-1	Thread Adaptor from BGS 7771 M14 x M20 x 39 mm
7771-2	Disassembly Adaptor from BGS 7771 M17 x M20 x 52 mm
7771-3	Disassembly Adaptor from BGS 7771 M20 x M20 x 49 mm
7771-4	Disassembly Adaptor from BGS 7771 M25 x M20 x 41 mm
7771-5	Disassembly Adaptor from BGS 7771 M27 x M20 x 41 mm

Injector Socket | 12.5 mm (1/2") Drive | Internal Hexagon 10 mm

12.5 1/2

- for loosening of the retaining ring of injectors
- is needed for injector disassembly
- with 7.5 mm bore



Item #		
4478		

Diesel Injector Puller Tool | 3 pcs.

- suitable for Mercedes-Benz CDI engines, series OM611, OM612, OM613
- sliding hammer (1.85 kg, length: 470 mm)
- thread adaptor for mounting on the injector internal thread M27 x 1.0 (injector side), internal thread M16 x 1.5 (sliding hammer side)
- extractor claw: M16 x 1.5 female thread (sliding hammer side), 12.2 mm claw distance / 15.5 mm claw height, 75 mm distance from connector of sliding hammer to extractor claw, 113 mm total height of extractor claw
- total length with threaded adaptor 500 mm
- total length with 570 mm claw

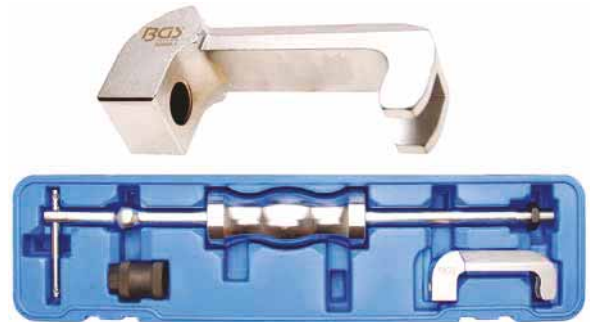

Item #	Description
62005	Diesel Injector Puller Tool 3 pcs.
62005-1	Injector Disassembly Claw

CDI Injector Extractor Set | 8 pcs.

- extra short, only 225 mm
- suitable for e.g. Bosch injectors built in BMW, Mercedes-Benz CDI engines OM 611, 612, 613 etc.
- total length: 350 mm injector pulling claw, 13 mm pulling claw opening with internal thread M12 x 1.75
- injector tension bolt with external thread M17 x 1.0 & external thread M14 x 1.5 for ball joint adapter
- injector sleeve with internal thread M27 x 1.0 & male thread M14x1.5 for ball joint adapter
- adapter with external thread M12 x 1.75 for pull claw & external thread M10 x 1.5 for slide hammer
- adapter with external thread M12 x 1.75 for pull claw & external thread M14 x 1.5 for ball joint adapter
- ball joint adapter with internal thread M14 x 1.5 for pulling claw / tension bolt / tension sleeve & external thread M10 x 1.5 for slide hammer
- sliding hammer sliding bolt, Ø 14 mm with internal thread M10 x 1.5 for adapters
- ball joint adapter & male thread M14 x 1.5 for handle
- handle length 74 mm, Ø 26 mm with internal thread M14 x 1.5
- sliding hammer weight 1730g with 14 mm bore

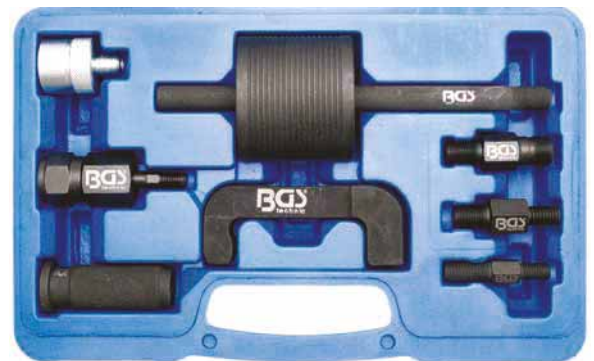

Item #	Description
62635	CDI Injector Extractor Set 8 pcs.
62635-1	Injector Disassembly Claw for BGS 62635
62635-2	Adaptor for BGS 62635 M27 x 1.0
62635-3	Ball Joint Adaptor for BGS 62635 M10 x M14

Injector Socket Set | 4 pcs.

12.5 1/2

- for removing the electrical unit of injectors
- deep sockets with wide cut-out
- fits the most popular injectors in modern vehicles
- sizes: 25 - 27 - 29 and 30 mm



Item #	
8351	

Injector Seat and Shaft Cleaning Set

- for cleaning of the injectors seats and glow plugs shafts
- 4 cleaning brushes
- brush holder
- 3 injector seat cutters
- cutter guide
- seal puller
- brush holder extension

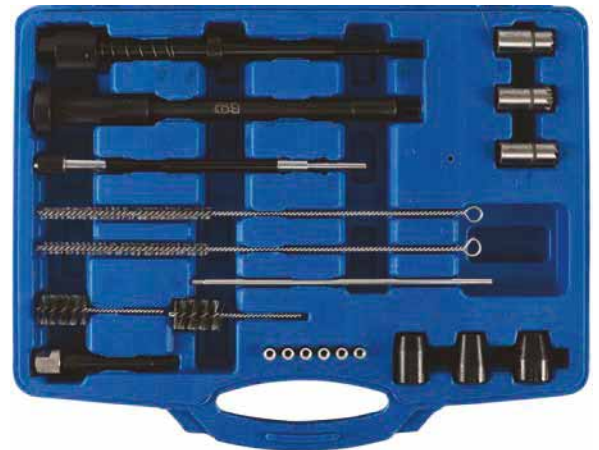

Item #
8723

Injector Sealing Surfaces Cutter Set | 9 pcs.

- milling cutter made of HSS steel
- for cleaning the sealing seats on the cylinder head or on the injector
- 1 universal milling cutter for injectors 15 x 19 mm
- 1 milling cutter 17 x 17 mm for BMW, PSA, Renault, Ford, Delphi and Bosch injectors
- 1 milling cutter 17 x 17 mm for Mercedes-Benz CDI
- 1 milling cutter 17 x 19 mm for Bosch injectors in Mercedes-Benz CRD
- 1 angled milling cutter 17 x 21 mm for FIAT and IVECO
- 1 injector seat cleaner 19 mm with external hexagon 19 mm
- 1 guide pin with external hexagon 19 mm, length: 172 mm
- 1 socket with T-handle, hexagon | 19 mm, length: 160 mm
- 1 L-type wrench, internal hexagon 2.5 mm



Item #
62604



Injector Sealing Cutter Set for CDI engines | 5 pcs.

- for reworking the injector seat when removing the injectors
- 19 mm external hexagon pilot
- 15 x 19 mm reamer fits various makes and models
- 17 x 17 mm reamer fits BMW, PSA, Renault
- 17 x 19 mm reamer fits for Mercedes-Benz CDI
- 17 x 21 mm offset reamer fits for Fiat, Iveco



Item #
62605

Grinder for 15 mm Injector Nozzle Face Cleaner

- suitable for Mercedes-Benz CDI
- for cleaning nozzle face area and nozzle chamber before changing/ replacing the injection nozzle or if nozzle has a leak
- turn manually and apply soft pressure for clean fit of the cylinder head and the nozzle and for cleaning the nozzle chamber
- can also be used with 13 / 17 mm sockets
- 15.5 mm grinding head diameter for nozzle shaft and fitting the nozzle in the cylinder head
- grinder length: 230 mm
- 20.0 mm grinding head diameter for nozzle cleaning at the nozzle
- length of grinding head is 35 mm



Item #
62606

Diesel Nozzle Extractor for Bosch and Lucas

- facilitates the extraction of diesel nozzles
- suitable for e.g. Bosch and Lucas nozzles with internal thread M8 x 0.75 and M12 x 1.5 / external screw thread M14 x 1.5
- length: 230 mm
- weight: 1000 g



Item #
8571

Special Wrench for Injection Lines | for BMW | 12.5 mm (1/2") Drive

- facilitates the disassembly / assembly of Diesel injection pipes on injectors and other pipe fittings
- includes special wrenches for the following injection pipes, for example:
 - 14 mm for BMW
 - 17 mm for BMW, Opel 2.5TD, Mercedes-Benz
 - 19 mm for Mercedes-Benz
- 12.5 mm (1/2") drive
- length: 119 mm
- satin chrome plated
- on socket rail



Item #	Description
8450	Pipe Wrench Set, open 12.5 mm (1/2") Drive 14 - 17 - 19 mm
8433	Special Wrench for Injection Lines for BMW 12.5 mm (1/2") Drive 14 mm
8432	Special Wrench for Injection Lines for BMW, Opel 2.5TD, Mercedes-Benz 10 mm (3/8") Drive 17 mm
8434	Special Wrench for Injection Lines for BMW, Opel 2.5TD, Mercedes-Benz 12,5 mm (1/2") Drive 17 mm
8435	Special Wrench for Injection Lines for Mercedes-Benz Drive 12.5 mm (1/2") 19 mm

Double Ring Spanner, Open | for Diesel Injector Pipes | 17 mm

- open double ring spanner, offset and angled
- surface finish: satin chrome plated
- profile: 12-point
- for hard to reach places
- suitable for most diesel engines
- wrench size: 17 mm



Item #	 
8291	

Injector Puller | for Mercedes-Benz CDI Engines

- suitable for Mercedes-Benz CDI engines 611, 612, 613 ff.
- for loosening injectors from the cylinder head
- no more disassembling of the cylinder head necessary
- striking weight 2.0 kg



Item #
1678

Sockets for Diesel Injectors

12.5  1/2



Item #	Description
2538	Socket for Diesel Injectors 12.5 mm (1/2") Drive 22 mm
2539	Socket for Diesel Injectors 12.5 mm (1/2") Drive 27 mm



Pre-Chamber Socket for Mercedes-Benz CDI

- 12.5 mm (1/2") drive multi-spline socket 1.5 x 58 mm
- allows changing of the diesel pre-chamber
- fits on MB engines from 1989
- suitable for engines with the following codes: 601, 602, 602.91, 603, 604, 605, 606, 661, 662
- to be used as OEM 603589000900 / 603589010900
- surface finish: phosphated

Item #	 
5430	



Special Wrench for Injection Lines | for Mercedes-Benz | 10 mm (3/8") Drive | 14 mm 10 3/8

- wrench size: 14 mm
- profile: 12-point
- surface finish: satin chrome plated
- length: 85.5 mm

Item #
8469



Injector Puller | for BMW

- for pulling out stuck common rail injectors
- disassembly of the cylinder head is not necessary
- support on the cylinder head allows high extraction forces
- suitable for BMW engines M47TU, M57, M57TU
- 2 support feet 115 mm
- 2 support feet 140 mm
- supporting bridge with ball bearing
- spindle M16, one side M17 thread, for mounting in the injector
- 29 mm socket for disassembling the electric unit
- internal 6-pt wrench for removing the injector needle

Item #
8782



HDI Injector Puller

- allows the extraction of Bosch and Siemens HDI injectors
- disassembly of cylinder heads is not necessary
- suitable for most vehicles with PSA 2.0 HDI DW10, DW12 engines, also on Toyota, Mazda, Hyundai
- high traction is reached by pulling the cylinder head
- 2 ball bearing puller spindles for injectors with different internal thread diameter
- 2 open sockets for removal of the electric unit
- high performance support frame with spindle bearings

Item #
8349



Engine & Attachments

Puller for Common Rail Injectors

- suitable for e. g.: Mercedes-Benz CDI engines 611, 612 and 613
- for pulling out stuck common rail injectors
- special tool construction allows to pull injector with high force
- heavy version



Item #	Description
8237	Puller for Common Rail Injectors
8237-29	Socket, Hexagon slotted 29 mm

Injector Puller | for Mercedes-Benz CDI engines | 4 pcs.

- suitable for assembling and disassembling tightly fit common rail injectors
- suitable for e. g. Mercedes-Benz CDI engines 611, 612 and 613
- suitable for working in confined spaces due to the low support cylinder diameter
- special tool construction allows to pull injector with high force
- 1 injector socket set, 12.5 mm (1/2") drive, internal hexagon 10 mm
- 1 protection ring for mounting under the pull-out sleeve
- 1 socket 29 mm, slot opening: 50 mm, drive: 22 mm
- 1 pulling spindle / pull-out sleeve, external hexagon drive: 21, 22 mm, slot opening: 85 mm



Item #
8244

Extractor for Common Rail Injector Needles

- the 3-jaw puller allows a safe removal even of stuck injectors
- it is not necessary to drill a hole into the injector needle, thus even injector needles, which rotate when drilling a hole can be removed



Item #
8309



Adjustment & O-Ring Mounting Tool Set for VAG Pump-Nozzle Unit

- allows precise positioning of the pump /nozzle unit and a damage-free installation of the O-rings
- not correctly installed pump/nozzle units present a risk of damage to the cylinder head and the pump/nozzle unit

suitable for following VAG Pump/Nozzle engines:

- 5 cyl. & 10-cyl. VW Phaeton, Touareg as of 2003, T5 as of 2004, etc.
- 4 cyl. VW Golf, Touareg, Audi A3 from 2004, etc.
- setting gauge, steel made, to be used as OEM T10210
- O-ring mounting sleeve, brass made, to be used as OEM T10056/1
- O-ring mounting sleeve, brass made, to be used as OEM T10056/2
- O-ring mounting sleeve, brass made, to be used as OEM T10056/3
- O-ring mounting sleeve, brass made, to be used as OEM T10164/1
- O-ring mounting sleeve, brass made, to be used as OEM T10164/2



Item #
8954

FSI Nozzle Assembly/Disassembly Set

- suitable for VW, Audi, Seat, Skoda with direct injection engines and engines with pump-injector units
- to be used as OEM tool kit T10133 + T10163
- puller for dismantling FSI injectors, use as T10133/1
- puller claw for dismantling FSI injectors, use as T10133/2
- sliding hammer, use as T10133/3
- cone for mounting the combustion chamber rings use as T10133/53
- calibration tools for mounting the combustion chamber rings, use as T10133/6, T10133/7, T10133/8
- built-in pin for mounting the FSI injectors, to be used as T10133/9
- extractor for dismantling pump-injector units



Item #
68345

Injector Removal Tool | for Air Hammers

- for disassembly of hard to remove injectors
- special construction with pulling rod and sliding clamp for extracting injectors with air hammers
- suitable for pneumatic hammer BGS 3515, injector dismantling claw from BGS 7777 and separate claws 7777-1, 7777-2, 7777-3
- material: S45C / Cr-Mo steel
- overall length: 510 mm
- handle length: 110 mm



Item #
9308



Injector Gasket Puller | 350 mm

- especially developed for extracting burnt in copper sealing washers from the injector shaft
- helps to avoid damages to the cylinder head
- slim construction with conical tip, knurled handle and sliding weight

Item #
62630-1



Injector Gasket Puller | 230 mm

- for removal of hard to loosen copper rings in the injector shaft of injection engines

Item #
62630



Injector Seat and Shaft Cleaning Set

- allows efficient cleaning of injector ports, injector nozzle ports in cylinder heads and injector seats
- suitable for a wide range of vehicles
- helps to avoid blow-back due to poorly seated injectors
- 3 steel wire brushes
 - brass coated
 - for removing combustion residues on injector ports
- 2 silicone nylon brushes
 - for cleaning injector seat surfaces in the cylinder head
 - provides a smooth surface on injector seat
- 1 extension bar with quick-action chuck for brushes
- 6 injector bore sealing plugs for sealing the combustion chamber during the cleaning process
- 1 mounting / disassembly rod for inserting / removing the sealing plug
- 1 steel wire brush for cleaning nozzle holes in the cylinder head

Item #
9324



Glow Plug Shaft Cleaning Brush

- for professional cleaning of the glow plug shaft
- cleaning of the shaft is recommended before installation of new glow plugs
- steel brush length: 105 mm, Ø 9 mm
- length: 310 mm

Item #
8561



Injector Extractor Set | for BMW Petrol Direct Injection

- allows easy removal of injectors and is required for installing fuel injector seals on e.g. following engines:
 - BMW N54 (6-cylinder), N63 (V8)
 - MINI N14 (4-cylinder), N18 (4-cylinder)
- sliding hammer with adaptor
- long bolt, 120 mm length
- short bolt, 70 mm length
- tapered cone, to be used as OEM 130195
- assembly sleeve with large diameter, to be used as OEM 130192
- assembly sleeve with medium diameter, to be used as OEM 130193
- assembly sleeve with small diameter, to be used as OEM 130194



Item #	
9017	

Fuel Injector Nozzle Tool Set | for BMW

- for removing / installing fuel injectors
- required for installing new injector seal rings and injectors

suitable for the following BMW models:

- 135is (2008-2010)
- 335 (2007-2010)
- 335xi (2007-2010)
- 535i (2008-2010)
- 535xi (2008-2010)
- 550i GT (2010-2013)
- 750i (2009-2013)
- 750Li (2009-2013)
- X3 3.0i (2007-2010)
- X5 (2011-2013)
- X5 3.0i (2008-2010)
- X6 (2008-2013)
- petrol injector tool for BMW N53 / N54 to be used as OEM 130180
- petrol injector tool for BMW N55 to be used as OEM 130270
- petrol injector tool for BMW N20 / N55 to be used as OEM 130320
- petrol injector tool for BMW N63 to be used as OEM 2249115
- injector tool, to be used as OEM 135250
- injector seal ring mounting tool set, to be used as 130190 / consisting of the following three tools:
 - injector seal ring mounting sleeve (Ø big), to be used as OEM 130192
 - injector seal ring mounting sleeve (Ø middle), to be used as OEM 130193
 - injector seal ring mounting sleeve (Ø small), to be used as OEM 130194
 - injector seal ring mounting cone, to be used as OEM 130195

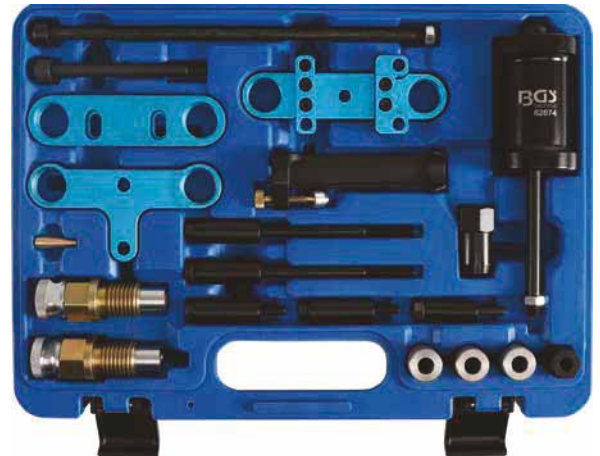

Item #
62674

Fuel Injector Tool for BMW

- for removing and mounting of fuel injector nozzles
- suitable for BMW inline cylinder turbo charged engines with direct injection from 2009
- to be used as BMW OEM 130270



Item #
62671

Injector Alignment Tool for Ford Duratorq | 2 pcs.

- for aligning the injectors to the fuel lines
- it is essential to have the injectors correctly aligned to avoid the risk of a fractured pipe
- suitable for Ford Duratorq engines 2.0 / 2.2 / 2.4 DI / TDCI / TDDI, built in Ford Mondeo 2000-2007 / Ford Transit 2000-2006 / Jaguar X-Type
- metal bar allows aligning of two injectors at the same time, to be used as OEM 303-678
- adjustable tool for aligning injectors, to be used as OEM 303-711



Item #
8884



Injector Puller | for Chrysler 2.5 & 2.8 CRD

- for extracting burnt and tightly stuck injectors
- suitable for Chrysler 2.5 / 2.8 CRD 16-valve VM engines



Item #
8771



Injector Sealing Plug Set | 12 pcs.

- for sealing the injector prior to pressure loss test on the engine
- protects the injector from contamination and adhesion when the fuel line is removed
- 6 lock nuts M12 x 1.50 (with inside sealing cone)
- 6 lock nuts M14 x 1.50 (with inside sealing cone)
- for Opel, Mazda, Ford, Mercedes-Benz and others
- for injectors from: Siemens, Bosch, Denso, Delphi





Item #
9540

Tool Tray 1/6: Thread Repair Kit | for Injector Fastening Screws | 10 pcs.

- suitable for Mercedes-Benz CDI engines
- for reaming the broken-off expansion bolt & repairing the M6 thread in the cylinder head
- time saving as the replacement of the cylinder head and the removal of injectors and valve covers is not necessary
- damaged thread is reworked to size M8 x 1
- 1 twist drill 6 mm, with adjusting ring for drilled depth
- 1 step drill 7 to 8 mm, with adjusting ring for drilled depth
- 1 guide sleeve for 6 mm twist drill
- 1 tap M8 x 1
- 1 assembly tool for threaded inserts
- 5 threaded inserts, inner thread M6 x 1 / outer thread M8 x 1



Item #		
9538		

Common Rail Diagnosis Kit | with 24 Adaptors

- flow back volume can be determined via glass tubes or measuring cups
- determination of the runback volume via glass tubes or measurement cartridges
- for common rail engines, up to 6 injector nozzles
- suitable for various injector brands
- includes 24 adaptors for Denso C3, C1, Siemens C3, Delphi, Bosch

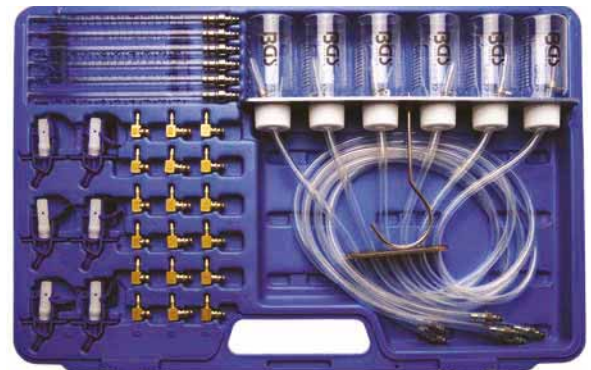

Item #
8102

Common Rail Diagnosis Kit

- flow back volume can be determined via glass tubes or measuring cups
- determination of the runback volume via glass tubes or measurement cartridges
- suitable for various injector brands



Item #	Description
8101	Common Rail Diagnosis Kit
8101-1	Replacement Tubes with Adaptor for BGS 8101 6 pcs.
8101-2	Plastic Bottle for BGS 8101, 8102
8101-LEER	Empty Case for BGS 8101

Adaptor for BGS 8101 | for Bosch, Denso, Siemens (Common Rail Diesel)

- to be used on injector nozzles together with common rail diagnosis kit BGS 8101
- addaptors fit all systems such as Siemens, Bosch, Denso etc.



Item #
8103

Injector Nozzle Tester

- tester contains gas canister, hand lever and pressure gauge with rubber protection
- for testing of injector nozzles
- suitable for all diesel injector nozzles (except CDI pump-injector elements)
- several characteristics of the injector nozzles can be tested:
 - opening pressure
 - spraying pattern
 - tightness of the nozzle
 - gas spraying pattern
 - acoustic control (sound pattern)
- pressure gauge up to 400 bar
- connecting hose and 3 adaptors included M12 x 1.5 mm, M14 x 1.5 mm and M17 x 0.75 mm
- large base with adaptation
- fuel tank made of plastic with integrated fine filter



Item #
62655

Injector Nozzle Tester

- for precise adjusting of the injection pressure and for checking the opening pressure of the nozzles, spraying shape, tightness
- includes two adaptors M12 x 1.5 & M14 x 1.5 and gauge up to 600 bar



Item #	Description
62650	Injector Nozzle Tester
62650-1	Plastic Container with Cover for BGS 62650
62650-2	Connector for BGS 62650 M12 x 1.5
62650-3	Connector for BGS 62650 M14 x 1.5

Pliers Set for Loosening Fuel Line Connectors | 3 pcs.

- suitable for Fiat, Ford, Opel, Peugeot, Renault, Citroen, VW



Item #	
8012	

Fuel Line Pliers | 230 mm

- for opening and closing fuel line clutches
- for removal and replacement of hose clip connections on in-line fuel filters
- a must-have when changing the fuel filter unit and repairing the engine
- used for Volkswagen VW-Audi, Fiat, GM, Opel, Mercedes-Benz (e. g. M class petrol engine) etc.



Item #	
8260	

Release Pliers for Fuel Pipes and Fuel Filters on VW, Fiat, Opel etc.

- for quick and easy separating of gasoline quick locks
- suitable for quick coupler fuel filters and similar connections
- for all quick coupler that are separated by pressure on the outer ring
- electroplated surface
- handle dip coated



Item #	
8274	

Removal Pliers for Fuel Lines

- for connections with rest tongues, such as those between fuel line and fuel filter
- suitable for VW, Audi, Volvo, Citroën, Fiat, Alfa and others
- angled head allows work in narrow spaces

Item #
66101



Pliers for Removing Fuel Lines with Quick Couplers

- for removing fuel lines with quick couplers on filter units, and fuel tank breather

suitable for the following models:

- Fiat, Alfa Romeo, Lancia 1.3, 1.9, 2.4 I Diesel
- Opel Vectra C 1.9, Signum 1.9, Astra H 1.3, Astra H 1.9 Diesel, Corsa C, Combo, Meriva 1.3 Diesel, Corsa B, Astra F, Astra G, Vectra B, Omega B Petrol
- Chrysler Neon 1.8, Stratus 2.0 and 2.5
- Renault passenger cars since 1997

Item #
8314



Pipe Connector Removing Kit | 22 pcs.

- removing and disconnecting tools for pipe connectors
- for air conditioning, fuel, air and oil pipes
- fits nearly all brands

Item #
8036



Pipe Connector Loosening Clip Set | 7 pcs.

- for pipes Ø 1/4", 5/16", 3/8", 1/2", 5/8", 3/4", 7/8"
- for quick connecting sleeves in air conditioning systems and fuel lines
- on PVC display board

Item #
8009



Fuel Pipe Wrench Set | for BMW | 2 pcs.

10 \square $\frac{3}{8}$ 12.5 \square $\frac{1}{2}$

- required when disassembling / assembling injection nozzles
- especially designed for BMW engines N54, N63 and S63, also suitable for many other vehicle models
- compact design for use in confined spaces
- side opening allows 180 degree rotation
- includes the following socket sizes:
 - socket, 12-pt, slotted, 17 mm, 12.5 mm (1/2") drive
 - socket, 12-pt, slotted, 14 mm, 10 mm (3/8") drive



Item #
9461



Fuel Line Tool for MINI Cooper

- for loosening the low pressure fuel feed line that supplies the high pressure fuel pump

suitable for following MINI Cooper S models:

- Clubman, JCW (R55), engine N14/18 (2008-03.2012)
- Hatchback, JCW (R56), engine N14/18 (2007-03.2012)
- Convertible, JCW (R57), engine N14/18 (2009-03.2012)
- Coupe, JWC (R58), engine N14/18 (2012-03.2012)
- Roadster, JWC (R59), engine N14/18 (2012-03.2012)
- Countryman, JWC (R60), engine N18 (2011-03.2012)
- to be used as OEM 130250



Item #
9153



Fuel Line Disconnecting Tool | for BMW

- facilitates the separation of fuel line connections
- made of anodised aluminium
- suitable for 3-series built during 1999 to 2005 and X5



Item #
66150



Tank Sensor Wrench, adjustable | 24 mm Drive

- all-purpose, adjustable from 75 to 160 mm
- for removing and tightening the plastic ring on fuel tank sender units



Item #
1001



Spanner Set for Fuel Tank Senders

- for assembly and disassembly of the plastic retaining rings of the fuel tank sender unit
- 5 different shaped pairs of clamping arms allow use on a variety of fuel tanks
- can be used for diameters of 75-160 mm, 80-122 mm and 110-170 mm
- can be used with 2 and 3 arms
- 24 mm drive



Item #
8355

Tank Sensor Wrench, adjustable | 12.5 mm (1/2") Drive

12.5  **1/2**

- all-purpose, adjustable from 80 to 199 mm
- suitable for most models of Mercedes, BMW, Audi, Volkswagen, Citroen, etc.
- for removing and tightening the plastic ring on fuel tank sender units



Item #
9376

Universal 3-Arm Tank Sensor Wrench | 89 - 170 mm

- for loosening and tightening the mounting ring on tank sensors
- allows working in tight spaces
- diameter: adjustable from 87 to 170 mm
- drive 19 mm hexagon



Item #
9063

Tank Sensor Wrench for VAG

- for dismantling of tank sensor units
- special profile with 99 mm diameter
- length: 390 mm



Item #
8535

Fuel Tank Wrench Set for Mercedes-Benz

- for loosening and tightening the fuel sensor

scope of delivery:

- Mercedes-Benz 129, 140, 230
- Mercedes-Benz 163, 203, 209, 211, 219
- Mercedes-Benz 202, 208



Item #
8749

Tool for Fuel Sensor Retaining Ring on VAG and Porsche

12.5 1/2

- for removing and installing the locking ring on tank level sensors
- 120 mm internal diameter with 3 slotted teeth
- to be used as OEM T10202 (3087)

suitable for following models as of year 2000:

- Audi A3, A4, A6, A7, A8, Q3, Q7, R8, TT
- VW Polo, Beetle, Golf, Golf Plus, Jetta, Eos, Scirocco, Passat, Passat CC, Sharan, Touran, Tiguan, Touareg, Phaeton, Caddy, Transporter
- Porsche Cayenne
- 12.5 mm (1/2") drive



Item #
8969

Spline Socket for Mercedes Diesel Engine Injection Pumps | 33 teeth

12.5 1/2

- for assembly and disassembly of the injector pump

suitable for the following Mercedes-Benz engines:

- OM 601 2.0 l / 2.2 l / 2.3 l
- OM 602 2.5 l / 2.9 l
- OM 603 3.0 l / 3.5 l
- OM 605 2.5 l
- OM 606 3.0 l
- OM 615 2.0 l / 2.2 l
- OM 616 2.4 l
- OM 617 3.0 l

- length: 56 mm



Item #
5350



Special Socket for Diesel Filters | 27 mm

12.5  1/2

- hexagon model
- overall height: 44 mm
- milled, 17 x 20 mm
- suitable for 2.0/2.2 HDI engines on Citroen, Ford, Lancia, Land Rover, Volvo, Peugeot

Item #
8630



Diesel Filter Removal Tool Kit | for Opel / Fiat

- prevents damage to the fuel filter housing
- clamping device for clamping the filter housing in a bench vice
- special wrench allows easy disassembly of the housing cover
- suitable for:
 - Opel engines DA13, Z13DT, Z13DTH, Z13DTJ, Z19DT, Z19DTL, Z19DTH (not for Corsa-D and Meriva as of 2007)
 - Fiat-/Lancia engines 1.3 16V MJTD, 1.3 16V JDT, 1.9 8V JTD, 2.0 8V JDT, 2.2 16V JTD, 2.3 16V JDT, 2.8 JTD 3.0 16V JDT (only for vehicles with fuel filter insert)

Item #
8553



Fuel Filter Wrench

10  3/8

- diameter 109 mm
- especially designed for installing and removing Citroen, Peugeot and Renault fuel filters

Item #
8416



Special Wrench for Fuel Filters on HDI Engines

- suitable for Peugeot, Renault, etc., with HDI engines
- 10 mm (3/8") drive
- for filter caps with Ø 108 mm with 46 grooves

Item #
8290

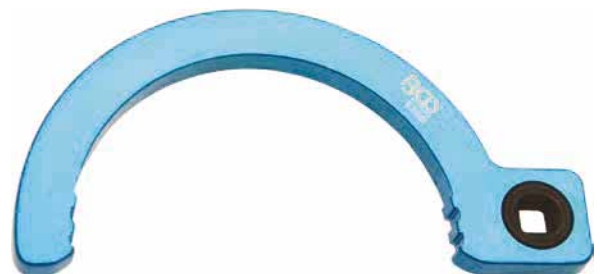

Diesel Fuel Filter Wrench for Volvo

10 3/8"

- for removing and installing fuel filters on Volvo Diesel engines
- suitable for
 - Volvo C30, C70, S40, S60, S80, V50, V60, V70, XC60, XC70, XC90
 - VW Crafter 5-cylinder diesel since 2006
- 10 mm (3/8") drive
- to be used as OEM Volvo 9997084, VW T50011



Item #
9021



Fuel Filter Tool for Diesel JTD / CDTi / DDiS / TiD / VCDi / HdI

- for changing the fuel filter insert on Chevrolet, Citroen, Fiat, Saab, Suzuki, Opel
- with following engines:
 - 1.3 JTD / CDTi / DDiS
 - 1.9 JTD / CDTi / TiD
 - 2.0 VCDi / HdI / JTD
 - 2.2 HdI / JTD
 - 2.8 HdI / JTD
 - 3.0 HdI / JTD



Item #
8935

Diesel Filter Wrench for VW 2.0 TDI

- special design for renewing of the diesel filter on Audi / VW / Skoda / Seat 2.0l TDi
- material: chrom molybdenum steel/S45C steel
- surface finish: satin chrome plated



Item #
8870

Fuel Filter Tool for VAG 1.4 / 1.9 / 2.0 TDI

- required for assembling the fuel filter housing cover when e. g. replacing the filter cartridge
- ensures an equal and distortion-free pressing of the housing cover into the sealing seat
- when assembling the filter cover without this tool there is the danger that the filter cap twists and the filter unit is leaking
- suitable for Audi, VW, Seat, Skoda diesel vehicles with UFI fuel filter unit



Item #
9212

Nozzle Gauge | 0.45 - 1.50 mm | 20 pcs.

- to check nozzles for damage
- Ø 0.45 - 0.50 - 0.55 - 0.60 - 0.65 - 0.70 - 0.75 - 0.80 - 0.85 - 0.90 - 0.95 - 1.00 - 1.05 - 1.10 - 1.15 - 1.20 - 1.25 - 1.30 - 1.40 - 1.50 mm

Item #
3041

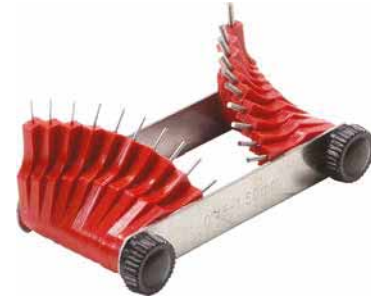

Carburetor Screwdriver with Drive Shaft

- facilitates the adjustment of carburettor kits, particularly suitable for work in tight spaces such as motorcycles
- suitable for slotted screws
- slot size: 1 x 5 mm
- adjustable depth stop 0 - 5.5 mm
- marked, lockable knurled sleeve for detecting the range of rotation
- length: 470 mm

Item #
4842



Diesel Bleeding / Primer Kit | 12 pcs.

- for bleeding the low pressure side on diesel fuel systems
- is required when renewing diesel filters and pumps or other components of the diesel injection system
- prevents defects of high pressure pumps (CDI) which frequently occur during renewing filters without manual filling
- includes 6 different adaptor hoses and hand pump with valve
- suitable for vehicles of the following brands: Ford, PSA, Opel, Fiat, Rover, Land Rover, Renault, Mercedes-Benz

Item #	Description
8819	Diesel Bleeding / Primer Kit 12 pcs.
8819-1	Tool Tray, empty: for BGS 8819



Hose / Tube Connector Kit for Bleeding Diesel Systems

- for bleeding / filling of diesel injection systems
- suitable for hose / pipe connections
- to be used with e. g. BGS 8080, 8066, 3157, 3155
- 90° angled coupling
- straight coupling
- rubber pipe connector
- straight coupling adaptor

Item #
8066-2



Socket Set for Bosch Distributor Injection Pumps | 5 pcs.

12.5  1/2

- is required when replacing, setting, disassembling and assembling Bosch diesel distributor injection pumps
- suitable for 3-point screw heads
- socket for EDC pump covers (1996-2003) on Bosch VP 37 distributor pumps
 - 6.3 mm (1/4") drive / external hexagon 15 mm socket, 3-point, 7 mm
- socket for Bosch distributor injection pumps (Bosch OEM No. 098661750)
 - 6.3 mm (1/4") drive - external square 12.5 mm (1/2") socket, 3-point, 12.6 mm
- socket for cover screws on distributor pumps
 - 12.5 mm (1/2") drive socket, 3-point, 13 mm
- socket for central screw (high pressure side) on Bosch VE and VP distributor pumps
 - 12.5 mm (1/2") drive socket, 3-point, 26 mm
- socket for pressure control valves on Bosch VP37 distributor pumps
 - 12.5 mm (1/2") drive with 2 surfaces, 12.4 mm



Item #	
9175	

Socket Set for Bosch Distributor Injection Pumps

12.5  1/2

- is required when replacing, setting, disassembling and assembling Bosch Diesel distributor injection pumps
- socket, 3-pt., 14 mm, for cover screws on distributor pumps, 12.5 mm (1/2") drive
- socket, 3-pt., 26 mm for central screw (high pressure side) on Bosch VE and VP distributor pumps, 12.5 mm (1/2") drive
- socket, with 2 areas, 12.4 mm pressure control valve on Bosch VP37 distributor pumps drive, 12.5 mm (1/2") drive



Item #	 
8827	

Sockets for Bosch Injection Pumps | 3-pt | 7 / 12.6 mm

- for loosening the triangle head screws in the flow controller cover
- suitable for Bosch common rail and TDI injection pumps
- sizes: 7 and 12.6 mm



Item #	
8953	

CNG Cylinder Valve Wrench

- for disassembly of gas cylinder valves

Item #	Description
64200	CNG Cylinder Valve Wrench for Fiat Multipla I
64201	CNG Cylinder Valve Wrench for Fiat Multipla II, Punto / Citroen C3
64203	CNG Cylinder Valve Wrench for Opel Zafira II, Combo
64204	CNG Cylinder Valve Wrench for Citroen C3 (small Valve)
64205	CNG Cylinder Valve Wrench for Citroen C3 (large Valve)
64206	CNG Cylinder Valve Wrench for Fiat Panda, Grande Punto
64207	CNG Cylinder Valve Wrench for VW Touran, Caddy, Passat
64208	CNG Cylinder Valve Wrench for Type NGT
64202	CNG Cylinder Valve Wrench for Opel Zafira I



Alternator Tool Set | 30 pcs.

10 $\frac{3}{8}$ 125 $\frac{1}{2}$

- for removing belt pulleys on alternators
- includes special bits, wrench and bit sockets
 - socket for 3-hole bolts, hole 28 mm, 3x 4 mm pins, 38
 - socket for 4-hole bolts, hole 26 mm, 4x 4 mm pins, 15
 - internal hexagon sockets with a through-hole for counterholding bits: 15 x 28 - 19 x 28 - 20 x 28 - 22 x 28 - 22 x 22 - 17 x 17 - 22 x 28 mm
 - multi-point sockets with a through-hole for counterholding bits: 33Z x 15 mm - 33Z x 17 mm - 33Z x 22 mm
 - bit sockets T-Star (for Torx) with 12.5 mm (1/2") drive: T50 x 200 mm - T50 x 145 mm
 - bit sockets internal hexagon (for Torx) with 12.5 mm (1/2") drive: M10 x 200 mm - M10 x 145 mm
 - bits 75 mm long, 10 mm drive: T-Star (for Torx) T40 - T50, spline (for XZN) M8 - M10, internal hexagon 8 mm - 10 mm
 - 12 mm ratchet wrench
 - bit sockets to be used with ratchet wrenches T50 x 65 mm, spline (for XZN) M10 x 65 mm
 - 12.5 mm (1/2") drive bit sockets: T50 x 115 mm - spline (for XZN) M10 x 115 mm with 33-tooth attachment
 - 10 mm (3/8") drive bit socket: spline (for XZN) M10 x 90 mm



Item #	Description
4248	Alternator Tool Set 30 pcs.
4248-4	33-tooth Attachment external Hexagon Drive for BGS 4248 15 mm
4248-2	Special Bit for Dismantling Belt Wheels on Alternators T-Star (for Torx) M50 x 64 mm
4248-3	Special Bit for Dismantling Belt Wheels on Alternators Spline (for XZN) M10 x 64 mm

Alternator Bit and Socket Set | 23 pcs.

- special bit set with alternator combination sockets (also for air conditioning compressors), for assembly and disassembly of the freewheel pulley
- multi-tooth 15 mm, 33 tooth, Ø17.5 mm socket
- multi-tooth 15 mm, 33 tooth, Ø19.5 mm socket
- multi-tooth 22 mm, 33 tooth, Ø19.5 mm socket
- adapter for pulley wrench, 19 mm and 28 mm
- adapter for pulley wrench, 22 mm and 28 mm
- 3-pin adapter, external hex drive 38 mm
- 4-pin adapter, external hex drive 17 bits, length 70 mm, hexagon 10 mm drive, hexagon H10 mm
- bits, length 75 mm, external hexagon drive 10 mm (3/8"), hexagon socket 8 and 10 mm, bits length 75 mm, external hexagon drive 10 mm (3/8"), spline (for XZN) M8 and M10
- bits, length 75 mm, external hexagon drive 10 mm (3/8"), T-star (for Torx) T40 and T50 bit adapter with retaining ball, square 12.5 mm (1/2") drive hexagon socket 10 mm (3/8") bit socket for alternator, external hex drive 12 mm, spline (for XZN) M10
- bit socket, length 90 mm, 10 mm (3/8") drive, spline (for XZN) M10
- bit socket, length 110 mm, 12.5 mm (1/2") drive, spline (for XZN) M10
- bit socket, length 140 mm, 12.5 mm (1/2") drive, spline for XZN) M10
- bit socket, length 110 mm, 12.5 mm (1/2") drive, T-star (for Torx) T50
- Special insert, external hex drive 17 mm
- special socket, external hex drive 21 mm
- special socket, external hex drive 22 mm and 28 mm
- incl. adapter for BMW, Fiat, Ford, Mercedes-Benz, Opel / Vauxhall, Porsche, Renault, Toyota, VAG etc.



Item #
4247



Alternator Bit/ Bit Socket Set | 12.5 mm (1/2") | 13 pcs.

12.5 1/2

- special bit set with alternator combination wrenches (also air conditioning compressor) for assembling belt pulleys
- spline pulley key, 15 mm, 33 teeth, bored
- spline pulley key, 22 mm, 33 teeth, bored
- adapter for pulley wrench 22 and 28 mm
- 4-pin adapter, 17 mm drive
- bits, length 75 mm, external hexagon 10 mm (3/8") drive, internal hexagon H8 and H10 mm
- bits, length 75 mm, external hexagon 10 mm (3/8") drive, spline (for XZN) M8 - M10
- bits, length 75 mm, external hexagon 10 mm (3/8") drive, T-Star (for Torx) T40 and T50
- bit socket for alternator, 12.5 mm (1/2") drive, spline (for XZN) M10
- bit socket for alternator, 12.5 mm (1/2") drive, T-Star (for Torx) T50
- bit adaptor with retaining ball, 12.5 mm (1/2") drive - internal hexagon 10 mm (3/8")
- includes adaptors for VW, Audi, Seat, BMW, Mercedes-Benz, Ford



Item #	Description
4246	Alternator Bit/ Bit Socket Set 12.5 mm (1/2") 13 pcs.
4246-LEER	Empty Case for BGS 4246

Alternator Tool Set | 4 pcs.

- for disassembly of alternators
- T-star (for Torx) bit T50, 64 mm long with 12 mm external hexagon and retaining ball
- spline bit M10 (for XZN), 64 mm long with 12 mm external hexagon and retaining ball
- 33 tooth bit with 15 mm external hexagon
- ratcheting ring spanner 12 mm

Item #	CV	
4249		



Alternator Bit Socket | 12.5 mm (1/2") Drive | T-Star (for Torx) T50

12.5 1/2

- for e. g. Mercedes-Benz A-class
- 33 tooth pulley holder
- profile: T-Star (for Torx) T50
- length: 110 mm

Item #	CV	
4240		



Alternator Bit Socket | 12.5 mm (1/2") Drive | Spline (for XZN) M10

12.5 1/2

- for VW, Audi, Skoda, Seat, Porsche BMW, Ford, Mercedes-Benz
- 33 tooth pulley holder
- profile: Spline (for XZN) M10
- length: 110 mm

Item #
4245



Flywheel Locking Tool Set | for BMW

- for locking of the crankshaft
- for locking the flywheel (crankshaft) when loosening the flywheel screws, loosening the crankshaft pulley screws or other jobs where a locking of the crankshaft is required
- suitable for following BMW engines: M47T2, M47TU, M57T2, M57TU, M67, N45, N45T, N46, N46T, N51, N52, N53, N54, W17
- to be used as OEM 118180, 118182, 118183, 118184, 118185

Item #
8573

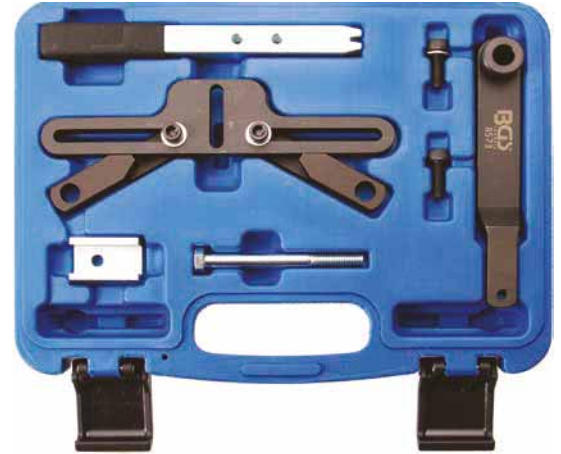

Engine Timing Tool Set | for MINI | 13 pcs.

- for engine codes W10, W11, N14
- suitable for following car models: MINI One, Cooper, Cooper S, Cooper S JC Cooper S JCW (series R50-52-53-55-56-57)
- camshaft assembling / disassembling
- crankshaft locking tool, to be used as OEM 119551 and 119552
- crankshaft locking tool, to be used as OEM 119590
- chain tensioner tool to, be used as OEM 119340

Item #
62618

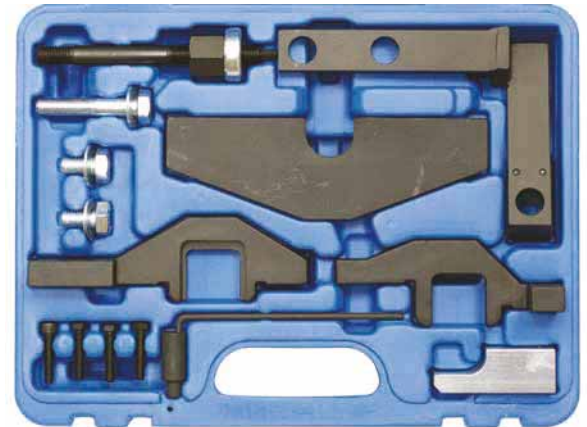

Engine Timing Tool Set | for BMW, MINI, PSA

- for aligning the new and old version of balance shafts
- prevents noncircular engine running by misaligned balance shafts
- is required when renewing timing chain, crankshaft sealing ring, replacing the cylinder head gasket, etc.

suitable for the following models:

- BMW 1.6 (N40 / N45 / N45T, B16, B16A, B16AC) 1.8 / 2.0 (N42 / N46 / N46T) 2.0 / 3.0 (N51 / N52 / N52-Component / N53 / N54)
 - PSA 1.4 / 1.6 16V (EP3 / EP6 / EP6DT / EP6DTS)
 - MINI 1.4 / 1.6 (N12 / N14)
 - locking tools for old and new version of balance shaft
 - crankshaft locking tool
 - locking pin for chain tensioner
- to be used as OEM 115140, 119280, 119330



Item #
8710

Engine Timing Tool Set | for MINI, PSA | 10 pcs.

- is needed for replacing the cylinder head sealing and engine timing

suitable for the following models:

- MINI One, Cooper HB, Cooper (R55-56) engine N12
- Citroen C4 (manufactured between 2008 and 2009), C4 Picasso (manufactured between 2008 and 2009)
- Peugeot 207 (manufactured between 2006 and 2009), 207CC (manufactured between 2007 and 2009), 308 (manufactured between 2001 and 2009)
- engines: 1.4 / 1.6 VTi, EP3 (8FS) EP6 (5FW), EP6C 1.6 THP, EP6DT (5FX) EP6DTS(5FY)
- crankshaft locking tool to be used as OEM 119590 / 0197-BZ
- camshaft locking tool to be used as OEM 119540 / 0197-A1 / 0197-A3
- chain tensioner to be used as OEM 119340 / 0197-M

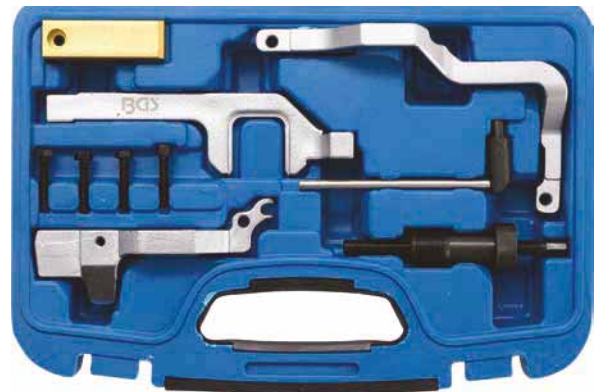

Item #
8302

Engine Timing Tool Set | for BMW M52, M54, M60, M62

- for adjusting and checking the engine timing
- suitable for the following BMW models: 320 E46 - 323 E46 - 325 E46 - 328 E46 - 330 E46 - 520 E39 - 520 E60 - 520 E39 - 523 E39 - 525 E39 - 525 E60 - 528 E39 - 530 E34 - 540 E34 - 535 E39 - 530 E39 - 530 E60 - 728 E38 - 730 E65 - 730 E35 - 730 E32 - 735 E38 - 740 E32 - 740 E38 - X3 E83 - X5 E53 - Z3 - Z4 E85
- camshaft adjusting tool (M52, M54), to be used as OEM 11 6 150
- vanos tool (M52, M54), to be used as OEM 11 3 450
- camshaft adjusting tool cyl. 1-4 (M60, M62), to be used as OEM 11 2 445 / OEM 11 2 441
- camshaft adjusting tool cyl. 5-8 (M60, M62), to be used as OEM 11 2 442 / OEM 11 2 446
- chain tensioner (M52, M54), to be used as OEM 11 4 220
- chain tensioner (M60, M62) to be used as OEM 11 4 230
- crankshaft adjusting tool, to be used as OEM 11 2 300
- adaptor (M52, M54)
- tensioner pin (M60, M62)



Item #
8534

Engine Timing Tool Set | for BMW N43

- for checking and adjusting the engine timing
- suitable for the following BMW models:**
- 1 (E81 - E82 - E87 - E88) 2006 - 2012
 - 3 (E90 - E91 - E92 - E93) 2006 - 2012
 - 5 (E60 - E61) 2007 - 2010
 - motorcodes: N43 (B16A/AA) - N43 (B20A) - N43 (B20AA) - N43 (B20AY) - N43 (B20KO) - N43 (B20UO)
 - tool for chain tensioner
 - camshaft locking tool
 - balance shaft locking tool
 - crankshaft locking tool
- to be used as OEM 113340 - 118690 - 118691 - 118692 - 118693 - 119340 - 119341 - 119342 - 118710 - 118711 - 118712 - 118700 - 115120



Item #
8570

Engine Timing

Engine Timing Tool Set | for BMW N47, N47S, N57

- for adjusting and checking the engine timing
- is required while dismantling and mounting the camshaft, replacing the timing chain and cylinder head gasket
- suitable for BMW Diesel engines with engine codes N47 - N47S - N57 - N57S, installed in the following vehicles:
 - 116d 118d 120d 123d, series E81 E82 E87 E88 F20
 - 316d 318d 320d 325d 330d series E90 E91 E92 E93 F30
 - 520d 525d 530d 530d GT 535d 535d GT M550d, series E60 E61 F07 F10 F11
 - 640d series F12
 - 730d 740d 750d, series F01
 - X1 1.8d 2.0d 2.3d, series E84
 - X3 1.8d 2.0d 3.0d, 3.5d series E83 F25
 - X5 3.0d 4.0d M5.0d, series E70
 - X6 3.0d 4.0d M5.0d, series E71
- crankshaft turning tool, to be used as OEM 116480
- camshaft locking tool, to be used as OEM 118760
- pump sprocket support sleeve, to be used as OEM 118740 / 118741 / 118742
- crankshaft pulley locking tool, to be used as OEM 115320



Item #
8724

Double Vanos Adjustment Tool Set for BMW M52TU / M54 / M56

- for setting the vanos units on BMW M52TU / M54 / M56 engines
- VANOS setting tool, to be used as OEM 116150
- pressure connection, to be used as OEM 113450
- secondary sprocket mounting device, to be used as OEM 116180



Item #		
8743		

Engine Timing Tool Set | for BMW N62, N73

- for checking and adjusting the engine timing

suitable for the following BMW models:

- E60, E61, E63, E64, E65, E66, E53
- 540i, 545i, 550i, 645i, 650i, 735i, 740i, 745i, 750i, 760i, X5
- with engines of the series:
 - N62 B40A, B44A, B48B (manufactured between 2003 and 2010)
 - N62 B44A, B48B (manufactured between 2003 and 2010)
 - N62 B36A, B40A, B44A, B48B
 - N73 B60A (manufactured between 2002 and 2008)
 - N62 B44A, B48A (manufactured between 2003 and 2007) Holder to use as OEM 119463
- timing chain tensioner, to be used as OEM 119340
- intake camshaft lock, to be used as OEM 119461
- exhaust camshaft lock, to be used as OEM 119462
- crankshaft lock, to be used as OEM 119451
- wheel segment, to be used as OEM 113460
- spacer, to be used as OEM 119452
- socket, to be used as OEM 119454
- special ring with pointer, to be used as OEM 119453
- crankshaft pin, to be used as OEM 119190



Item #
8746

Engine Timing Tool Set | for BMW M42, M50

- for adjusting the engine timing after e. g. changing the timing chain or cylinder head gasket
- suitable for BMW engines M42 and M50
- camshaft locking tool
- flywheel locking tool
- to be used as OEM 113240 and 112300



Item #	
8747	

Engine Timing Tool Set | for BMW M60 / M62

- for adjusting the engine timing after changing the timing chain and cylinder head gasket, for example
- suitable for BMW engines M60 and M62
- camshaft locking tool
- flywheel locking tool
- to be used as OEM 112441, 112442, 112445, 112446, 112300, 113390



Item #
8748

Camshaft Bearing Cap Tool | for BMW N51 / N52

- for installation of the exhaust camshaft bearing strip
- is used when replacing the camshaft
- to be used in combination with BGS 62619
- press-down tool, 2-cylinder, to be used as OEM 114 461
- 2 M7 screws, to be used as OEM 114 462
- 6 thrust pieces, to be used as OEM 114 463

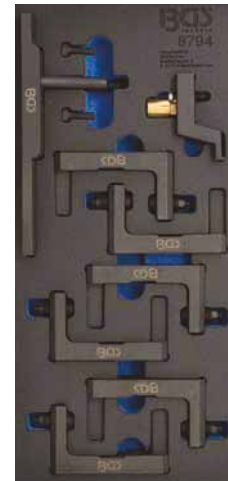

Item #
8794

Engine Timing Tool Set | for BMW N42, N46, N46T

- for adjusting / checking the engine timing and vanos unit

suitable for the following BMW models:

- E81 (116i / 118i / 120i) E87 (118i / 120i)
- E88 (120i) E46 (316i / 316ti / 316i / 318ci / 318ti)
- E90 (318i / 320i) E91 (318i / 320i) E92 (320i)
- E93 (320i) E60 (520i) E83 (X3 2.0) E85 (Z4 2.0)
- pre-tensioning tool, to be used as OEM 119340
- sensor gear alignment tool, to be used as OEM 119350
- inlet camshaft locking tool, to be used as OEM 119292
- exhaust camshaft locking tool, to be used as OEM 119291
- flywheel locking pin, to be used as OEM 115120
- camshaft alignment tool, to be used as OEM 119270
- screw for camshaft locking tool, to be used as OEM 119293
- crankshaft locking tool, to be used as OEM 119190

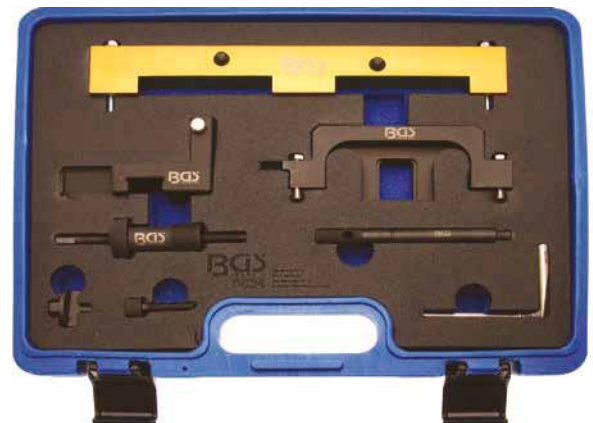

Item #
8834

Engine Timing Tool Set | for BMW, Land Rover V8

- for adjusting and checking the engine timing
- required for e. g. working on valve drive and renewing the cylinder head gasket

suitable for the following models:

- BMW 530i (1994 - 1995), 540i (1997 - 2003), 740i (1993 - 1995), 740iL (1993 - 2001), 840Ci (1995 - 1996), X5 (2000 - 2003)
- Rover Range Rover with M60, M62 and M62TU V8 engines
- exhaust camshaft locking tool (cyl. 1-4), to be used as OEM BMW 112445 | Rover LRT 12-223/2
- inlet camshaft locking tool (cyl. 1-4), to be used as OEM BMW 112441 | Rover LRT 12-223/1
- inlet camshaft locking tool (cyl. 5-8), to be used as OEM BMW 112442 | Rover LRT 12-223/3
- exhaust camshaft locking tool (cyl. 5-8), to be used as OEM BMW 112446 | Rover LRT 12-223/4
- fixing tools for camshaft locking tools (A-D)
- crankshaft alignment pin to be used as OEM 112300
- timing chain pre-tensioner, to be used as OEM 113390



Item #		
9071		

Crankshaft Pulley Holder and Rotating Tool Set | for BMW 2.5D

- for rotating the diesel engine crankshaft and holding the crankshaft pulley while loosening or tightening the middle pulley bolt
- allows safe and damage-free removing and installation of crankshaft pulleys
- suitable for 2.5 l diesel engines, built in BMW models: 325, 330, 335, 525, 530, 535, 730
- engine codes: M57N256D2, M57306D3, M57306D4, M57306D5, M57D30A, M57N206D3, M57N2306D3, M57N306D2, M57N306D3, M57N306D5, N57N306D2, N57N306D3
- crankshaft pulley holding tool, to be used as OEM 117222, 117223, 117221
- crankshaft rotating tool, to be used as OEM 116480



Item #		
9309		

Crankshaft Holding Tool | for BMW N47 / N57

- for locking the crankshaft
- to be used as OEM 114320
- required when replacing the secondary drive chain
- supplementary tool for engine timing tool set for BMW BGS 8724

Item #
9422



Engine Timing Tool Set | for BMW 1.6

- suitable for timing chain driven petrol engines with vanos, engine codes N40, N45, N45T (B16)
- for the following BMW models: 116 1.6 i E81/ E 87316 1.6 i E46 / E90316 1.6 Ci E46316 1.6 ti E46
- crankshaft timing pin to be used as OEM 119190
- timing chain pre-tensioning tool to be used as OEM 119340, 119341
- camshaft alignment tool (inlet) to be used as OEM 117252
- camshaft alignment tool (exhaust) to be used as OEM 117251
- vanos setting tool, to be used as OEM 117260



Item #
62614

Engine Timing Tool Set | for BMW Diesel | 13 pcs.

- suitable for the following models:
 - BMW 1, 3, 5, 6, 7, X3, X 5 (E34-36-38-39-66-83-90-91-92-93 series)
 - Landrover Range Rover, Freelander
 - Rover 75, MG, MG ZT
 - Vauxhall / Opel Omega-B
- engine codes:
 - M41, M51, M47 M47 TU/T2, M57 TU/T2 2.0l/3.0l 1998-2008
 - 204D3 / Td4, Td 6
 - M47R
- timing chain counterholder, to be used as OEM BMW 113360 / Range Rover LRT-12-115
- camshaft locking tool, to be used as OEM BMW 116321 (116320) / Opel KM6267
- holder for camshaft locking tool, to be used as OEM BMW 116322 (116320)
- injection pump puller (long), to be used as OEM BMW 135120
- injection pump puller, to be used as OEM BMW 135120 / Range Rover LRT-12-119
- injection pump puller (short), to be used as OEM BMW 135191, 135192 (135190) / Opel KM6270
- threaded ring, to be used as OEM BMW 135191, 135192 (135190) / Opel KM6270
- camshaft locking tool, to be used as OEM BMW 113320 / Rover LRT-12-112
- crankshaft locking pin, to be used as OEM BMW 115180
- crankshaft locking pin, to be used as OEM BMW 116080
- tensioner locking pin, to be used as OEM BMW 113340 / Range Rover LRT-12-114 / Opel KM-823
- crankshaft locking pin, to be used as OEM BMW 112300 / Range Rover LRT-12-108

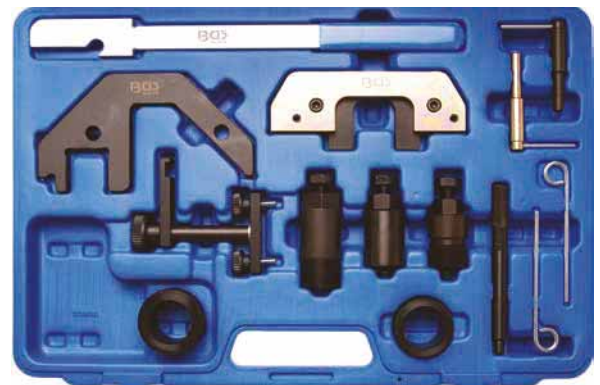

Item #	Description
62616	Engine Timing Tool Set for BMW Diesel 13 pcs.
62616-2	Camshaft Locking Tool for BMW for BGS 62616

Engine Timing

Engine Timing Tool Set | for BMW Petrol Engines | 26 pcs.

- for engine codes N42, N46, B18/-A, B20/-A/-B
 - suitable for the following models:
 - BMW 1, 3, 5, X3, Z4 (E87-46-60-85-83-90-91 series)
 - for camshaft assembling / disassembling
 - valve timing of camshafts
-
- clamps for intermediate lever, to be used as OEM 119310
 - bearing bridge holder, to be used as OEM 119320
 - thumbscrew, to be used as OEM 119302
 - eccentric shaft holder, to be used as OEM 119301
 - camshaft locking tool, to be used as OEM 119290
 - camshaft locking tool (inlet), to be used as OEM 119302
 - clamping tool, to be used as OEM 119340
 - spring holder, to be used as OEM 119390
 - camshaft sensor tool, to be used as OEM 119350
 - fastening screw, to be used as OEM 119390
 - camshaft rotation key, to be used as OEM 119270
 - crankshaft locking tool (straight), to be used as OEM 112300
 - mounting bolts 3x, to be used as OEM 119320
 - fastening screw, to be used as OEM 119290
 - camshaft locking tool, to be used as OEM 119290
 - crankshaft locking tool (angled), to be used as OEM 119190
 - mounting bolts, to be used as OEM 119320
 - setting tool for balancer shaft to be used as OEM 119330



Engine Timing

Item #	Description
62617	Engine Timing Tool Set for BMW Petrol Engines 26 pcs.
62617-14	Camshaft Locking Tool for BMW N42 / N46 for BGS 62617

Engine Timing Tool Set | for BMW N51, N52, N52K, N53, N54, N55

- for engine codes: N51, N52, N52K, N53, N54, N55
- contains important tools, e. g.: camshaft assembling / disassembling, timing belt change, checking and adjustment of valve timing

suitable for the following models:

- E60 523i ,523Li, 525i, 525Li, 525xi, 528i,528xi, 530i, 530Li, 530xi, 535i, 535xi
 - E61/E63 523i, 525i, 525xi, 530i, 530xi, 535xi, 630i
 - E64/E65 630i, 730i
 - E66/E70 730Li, X5 3.0Si
 - E81/E82 130i, 135is
 - E93 325i, 328i, 330i, 335i
 - E83 X3 2.5i, 2.5Si, 3.0i, 3.0Si
 - E85/E86 Z4 2.5i, 2.5Si, 3.0i, 3.0Si, Z4 3.0Si
 - E87/E90 130i ,323i, 325i, 325xi, 328i, 328xi, 330i, 330xi, 335i, 335xi
 - E91 323i, 325i, 325xi, 328i, 328xi, 330i, 330xi, 335i, 335xi
 - E92 323i ,325i, 325xi, 328i, 328xi, 330i, 330xi, 335i
-
- flywheel locking tool, to be used as OEM 110300
 - camshaft locking tools, to be used as OEM 114280, 114281, 114282, 114283
 - camshaft wheel adjusting tool, to be used as OEM 118520
 - camshaft wheel adjusting tool, to be used as OEM 112904



Item #
62619

Engine Timing Tool Set | for BMW N63

- for adjusting the engine timing when replacing timing chain, cylinder head repair, replacing the cylinder head gasket, etc.
- crankshaft locking tool, to be used as OEM 118570 / 119190
- camshaft locking tool, to be used as OEM 119890
- thumbscrew, to be used as OEM 119891
- depressing bar, to be used as OEM 119892
- snap gauge for intake and exhaust camshaft, to be used as OEM 119893
- spacer, to be used as OEM 119894



Item #
62627

Engine Timing

Engine Timing Tool Set | for BMW S54 | 8 pcs.

- for checking and setting camshaft timing when installing vanos adjustment unit on S54 engines
- suitable for the following models:
 - BMW M3 convertible (00-06), Sports Coupe (99-06), CSL Sport Coupe (03-04)
- to be used as OEM 119140, 119130119170, 117340, 115100, 17160, 112300, 110480



Item #
62634

Engine Timing Tool Set | for BMW N20, N26 | 10 pcs.

- for checking and setting camshaft timing when e. g. working on the valve train, renewing the cylinder head gasket, etc.
- suitable for the following BMW models:**
- 320i (F30) (2.0L N20B20) since 2012
 - 328i (F30) (2.0L N20B20) since 2012
 - X1 xdrive20i, sdrive20i (E84) (2.0L N20B20) 2010-2012
- to be used as OEM 83302212831, 83302212830, 83302219548, 119340



Item #	Description
62637	Engine Timing Tool Set for BMW N20, N26 10 pcs.
62637-1	Empty Case for BGS 62637

Engine Timing Tool Set | for BMW N13, N18

- for checking and setting camshaft timing when e. g. working on the valve train, renewing the cylinder head gasket, etc.
- suitable for the following BMW models:**
- 114i (F20) (N13B16) since 07/2012
 - 116i (F20) (N13B16) since 09/2011
 - 316i (F30) (N13B16) since 11/2012
 - 118i (F20) (N13B16) since 09/2011
 - 320i EfficientDynamics (F30) (N13B16) since 11/2012
- to be used as BMW OEM 117440, 119340, 496709, 119590, 2299362



Item #
62672

Engine Timing Tool Set | for BMW M62 Vanos

- for checking and adjusting the engine timing
- suitable for e. g. following engine series: M62B35 - M62B44 - M62TUB44
- vanos valve socket, to be used as OEM 11 6 42
- chain tensioner tool, to be used as OEM 11 7 380
- rotating tool, to be used as OEM 11 6 440
- transmitter wheel tool set, to be used as OEM 11 6450, consisting of:
 - transmitter wheel tool for cylinder 1 to 4, to be used as OEM 11 6 451
 - transmitter wheel tool for cylinder 5 to 8, to be used as OEM 11 6 452
- camshaft locking tool for cylinder 1 to 4, to be used as OEM 11 2 445 / 11 2 441
- camshaft locking tool for cylinder 5 to 8, to be used as OEM 11 2 442 / 11 2 446
- chain tensioner, to be used as OEM 11 3 390
- crankshaft locking tool, to be used as OEM 11 2 300



Item #
8602

Tool Tray 1/3: Engine Timing Tool Set | for BMW S65

- for adjusting the engine timing, when replacing the timing chain, cylinder head gasket, etc.
- suitable for following models with S65 engines: BMW M3 E90 / E92 / E93 (>2007) Wiesmann MF4 (>2009)
- camshaft adjusting tool (inlet), to be used as OEM 11 9 971
- camshaft adjusting tool (exhaust), to be used as OEM 11 9 972
- crankshaft locking tool, to be used as OEM 11 5 320
- vanos adjusting tool, to be used as OEM 11 5 370
- chain tensioner locking tool, to be used as OEM 11 5 290
- 6 mounting screws for camshaft adjusting tools



Item #	
9458	

Crankshaft Rotating Tool | for BMW M52 / M54 / M56

12.5 1/2

- for holding the crankshaft pulley while loosening or tightening the middle pulley bolt
- allows safe and damage-free removal / installation
- to be used as OEM 116480



Item #
8742

Belt Pulley Counterholding Wrench | for BMW M52TU / M54 / M56

- for holding the crankshaft pulley while loosening or tightening the middle pulley bolt
- allows safe and damage-free removal / installation



Item #
8744

Belt Pulley Counterholding Wrench | for BMW M52TU / M54 / M56

- for holding the crankshaft pulley while loosening or tightening the middle pulley bolt
- allows safe and damage-free removal / installation
- to be used with 12.5 mm (1/2") ratchet, sliding T-bar, etc.



Item #
8745

Balance Shaft Adjusting Tool | for BMW N40 / N42 / N45 / N46

- for adjusting the balancer shaft



Item #
8832

Fuel Injector Tool | for BMW N20 & N55

- for disassembly and assembly of fuel injectors on gasoline direct injection engines N20 and N55



Item #
8907

Intermediate Lever Spring Tool | for BMW

- for disassembly and assembly of pressure springs on the valve intermediate lever
- suitable for BMW engines N20, N51, N52, N52K, N52T, N55
- ensures quick, easy and safe handling of these high-force springs
- to be used as OEM 114270



Item #
8921

Water Pump Holder | for BMW M60, M62, M62TU

- for holding the water pump hub during removal of the fan clutch
- each side of the tool is applicable to different models
- side 1 for engine M60 / M62 / M62TU [V8]
- side 2 for engine M10 / M20 / M30 (32 mm fan clutch)



Item #
9223

Assembly Tool for injection Pump wheel | for BMW

- holds the sprockets during the assembly of the injection pump
- suitable for BMW engines M47 / M47T2 / M47TU / M57 / M57TU
- suitable for series: E46 (318D-320D) (1988 - 2005) and E60, E61 (318TD-320TD-525D-530D-530-535) (2000 - 2006)



Item #
62050



Timing Chain Pre-Tensioning Tool | for BMW N63

- is required when setting the engine timing
- an adjustment of the engine timing without this tool may lead to incorrect setting
- to be used as OEM 119900



Item #
62626

Balance Shaft Adjusting Tool | for BMW N20

- for fixing the balancer shaft and holding chain sprocket
- to be used for repairing the chain and sprocket wheel drive

- 1 balancer shaft locking pin to be used as OEM 2212825
- 1 chain sprocket holder to be used as OEM 2318117
- 2 screws PH3 M6 x 1,0 hex drive size 10 (length: 26mm)

Item #
9442



Engine Timing Tool Set | for Chrysler 2.5 CRD

- for setting and checking the engine timing

suitable for the following models:

- Chrysler Voyager, Grand Voyager R2516C, R2516L, R2816K engines
- Jeep Cherokee (2001 - 2008) 2.5 / 2.8 engines
- LDV Maxus (2005 - 2008) VM2516L engines
- camshaft locking pin (inlet) to be used as OEM VM1052
- camshaft locking pin (exhaust) to be used as OEM VM1053
- flywheel locking pin (Voyager, Grand Voyager 2.5 / 2.8 and LDV Maxus) to be used as OEM VM1068 / VM1089
- flywheel locking pin (Jeep Cherokee 2.8) to be used as OEM VM1080
- flywheel locking pin (Jeep Cherokee 2.5) to be used as OEM VM8873
- tensioner wrench to be used as OEM VM9660
- balancer shaft locking pin
- flywheel locking pin

Item #
8500



Engine Timing Tool Set | for Chrysler, Jeep, Dodge 2.8l Diesel

- for checking / setting the engine timing

suitable for the following Chrysler models:

- Grand Voyager
- Jeep Cherokee
- Wrangler
- Dodge Nitro
- engine codes: VM64C, ENS, ENS (51C), 49C, 50C, ENS VM10D, ENS VM11D
- camshaft locking tool, to be used as OEM VM9991
- crankshaft locking tool, to be used as OEM VM9992

Item #
9379



Engine Timing Tool Set | for Mercedes-Benz / Chrysler

- includes tools for adjusting the camshaft and locking the crankshaft (flywheel)

suitable for the following models:

- Mercedes-Benz 190 / C / CLK / E / S / SL / SLK / G / M / Vito / Sprinter / Viano / PT Cruiser / Grand Cherokee

petrol engines:

- 1.8 / 2.0 / 2.2 / 2.3 / 2.5 / 2.8 / 3.0 / 3.2 / 3.3 / 4.2 / 5.0 / 6.0
- with engine codes 102 / 111 / 104 (except for AMG) / 119 / 120

diesel engines:

- 2.0D / 2.2D / 2.3D / 2.5D / 2.5DT / 2.9D / 2.9TD / 3.0D / 3.0DT / 3.5D / 3.5DT / 2.0 CDi / 2.2 CDi / 2.3 CDi / 2.7 CDi / 3.2 CDi / 3.5 CDi / 3.9 CDi / 4.0 CDi / 2.2 CRD / 2.7 CRD
- with engine codes 601 / 604 / 605 / 611 / 646 / 612 / 602 / 603 / 606 / 612 / 613 / 646 / 647 / 648 / 628 / 603 / 613 / 628 / 648 / 646 / 602 / 603 / EDJ
- flywheel locking tool, incl. 2 x M6 x 90mm bolts, to be used as OEM 601589024000, 8933
- flywheel locking tool, to be used as OEM 112589034000
- camshaft locking pin set, to be used as OEM 602589004000, 8929



Item #		
9326		

Engine Timing Tool Set | for MINI, Citroen, Peugeot 1.6l Diesel

- for checking / adjusting the engine timing

suitable for the following models with 1.6 diesel engine:

- MINI / MINI Clubman, R55 / R56 / R57 series
- Citroen C2 / C3 / C4 / C5 / Grand Picasso / Berlingo (MK3) / Xsara Picasso
- Peugeot 206 / 206cc / 207 / 207cc / 1007 / 307 / 308 / 308cc / 3008 / 5008 / Partner (MK3)
- engine codes: W16D16 (9HZ), W16D16UO, or 9HZ / 9HX / 9HY (DV6TED4)
- crankshaft locking pin, to be used as OEM PSA 0194A / BMW 119790
- timing pin for camshaft / high pressure pump, to be used as OEM PSA 0194B / BMW 110300
- flywheel holding tool, to be used as OEM 119850 / 119851 / 119852



Item #
9214

Engine Timing Tool Set | for Fiat, Lancia, Alfa Romeo

- special socket, 12.5 mm (1/2") for disassembling the phase adjuster
- 23 custom fit timing tools for inlet camshaft and exhaust camshaft
- prevent distortion of camshafts and allow setting them in mounting position for the timing belt
- locking tools are numbered and have different colours to avoid mix-up
- can also be used for exact positioning of the crankshaft using the TDC setting plug and an optional micrometer (BGS 1938-1, not contained in this set).

suitable for the following models:

- Fiat Bravo 1.4 12V, 2.0 20V - Brava 1.4 12V, 2.0 20V - Marea 2.0 20V, Coupe 1.8 16V, Barchetta 1.8 16V, Punto 1.8 16V
- Lancia K5 2.0 20V - 4 cyl. VIS engines as of 1996 - Delta 1.8 16V Step A - Dedra 1.8 16V Step A - Y10 1.4 12V
- Alfa Romeo 145 1.4, 1.6 16V Step A - 146 1.4, 1.6 16V Step A - 147 1.6 16V Step A - 147 105 HP - 147 1.6 eco 103 HP - 155 1.4, 1.6 16V Step A - 156 1.6 16V Step A - 156 1.8, 2.0 16V - 156 2.0 JTS - 166 2.0 - GTV 2.0 JTS - Spider GT 2.0 JTS 16V 165 HP
- camshaft locking tool, to be used as OEM 1 825 041 000, 1 825 042 000, 1 860 096 100, 1 860 819 000, 1 860 847 000, 1 860 892 000, 1 860 899 000, 1 870 797 000
- holder for gauge for adjusting piston TDC (gauge is required), to be used as 1 860 895 000, 1 895 879 000, 1 825 013 000
- socket for phase adjuster, to be used as OEM 1 822 110 000, 1 852 161 000

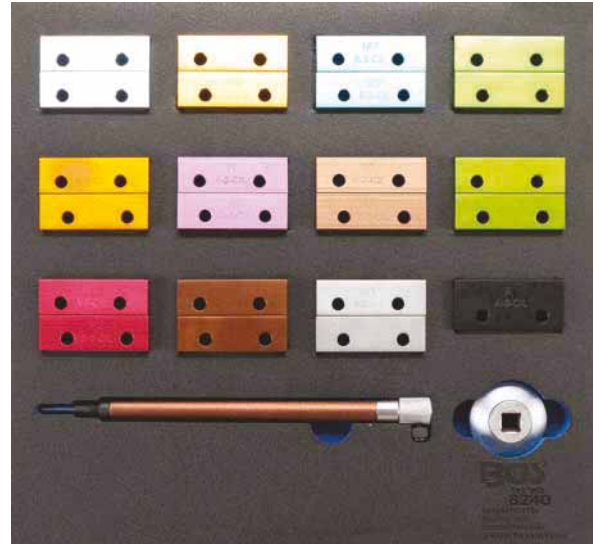

Engine Timing

Item #	
8240	

Engine Timing Tool Set | for Alfa Romeo 1.4, 1.6, 1.8, 2.0 Twin-Spark

- for adjusting the engine timing during timing belt replacement, cylinder head repair, replacement of the cylinder head gasket, etc.
- suitable for Alfa Romeo models 145 / 146 / 147 / 155 / 156 / 166 / Spider / GTV
- suitable for Twin Spark engines 1.4 / 1.6 / 1.8 / 2.0 l 16V Twin Cam, engine codes 162.01 / 322.01 / 323.01 / 323.10 / 335.03 / 671.06 / 672.04 / 676.01
- timing belt tensioning tool, to be used as OEM 1822149000
- balancer shaft belt tensioning tool, to be used as OEM 1822154000
- camshaft setting tool (purple), to be used as OEM 1825042000
- camshaft setting tool (blue), to be used as OEM 1825041000



Item #
8786

Camshaft Locking Tool Set | for Alfa Romeo 147 1.6 105 HP

- to check and adjust the camshaft timing
- required when replacing the timing belt

suitable for:

- Alfa Romeo 147 1.6 105 HP
- inlet and exhaust camshaft locking tool to be used as OEM 1870797000

Item #	
9216	

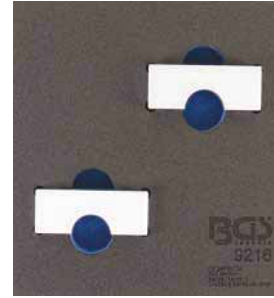

Camshaft Locking Tool Set | for Alfa Romeo 2.0 JTS

- to check and adjust the camshaft timing
- required when replacing the timing belt

suitable for Alfa Romeo:

- 156
- GT
- GTV
- Spider 2.0 JTS (165 HP)
- engine codes: 937A1000, 932A2000
- balance shaft clamping tool, to be used as OEM 1822154000
- belt tensioning tool, to be used as OEM 1822149000
- inlet camshaft locking tool, to be used as OEM 1860856001
- outlet camshaft locking tool, to be used as OEM 1860831002

Item #	
9217	

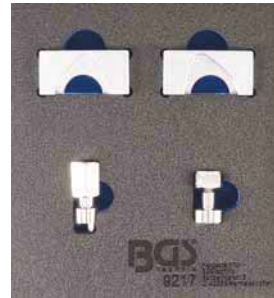

Camshaft Locking Tool Set | for Alfa Romeo / Lancia 3.0I V6 24V

- for checking / adjusting the engine timing
- to be used as OEM 1825040000

suitable for:

- Alfa Romeo / Lancia 3.0L V6 24V
- camshaft locking tool for inlet cam cylinder 1
- camshaft locking tool for outlet cam cylinder 1
- camshaft locking tool for inlet cam cylinder 6
- camshaft locking tool for outlet cam cylinder 4

Item #	
9227	



Engine Timing

Camshaft Locking Tool Set | for Alfa Romeo 1.6l 16V

- for checking / adjusting the engine timing
- to be used as OEM 1870734000

suitable for:

- Alfa Romeo 145/146/147/156 1.6 16V (Step"A")
- camshaft locking tool for inlet cam cylinder 2
- camshaft locking tool for outlet cam cylinder 3

Item #		1 6
9264		



Camshaft Locking Tool Set | for Alfa Romeo 1.8l / 2.0l 16V

- for checking / adjusting the engine timing
- to be used as OEM 1825041000

suitable for:

- Alfa Romeo 147 /156
 - 1.8 16V (140 HP) / 1.8 16V (144 HP)
 - 2.0 16V (150 HP) / 2.0 16V (155 HP)
- camshaft locking tool for inlet cam cylinder 2
- camshaft locking tool for outlet cam cylinder 3

Item #		1 6
9265		



Camshaft Locking Tool Set | for Alfa Romeo 2.0l 16V JTS

- for checking / adjusting the engine timing
- to be used as OEM 1870859000

suitable for:

- Alfa Romeo 147 / 156 / 166 / GTV / Spider GT with 2.0 16V JTS (165 HP) engine
- camshaft locking tool for inlet cam cylinder 2
- camshaft locking tool for outlet cam cylinder 3

Item #		1 6
9266		



Camshaft Locking Tool Set | for Alfa Romeo 1.6l ECO

- for checking / adjusting the engine timing
- to be used as OEM 1870797000

suitable for:

- Alfa Romeo 147 (937) 1.6L 77KW ECO Twin Spark
- camshaft locking tool for inlet cam cylinder 3
- camshaft locking tool for outlet cam cylinder 2

Item #		1 6
9268		

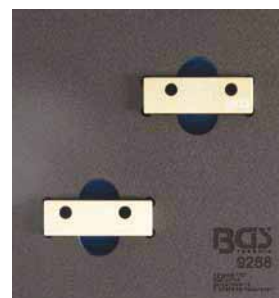

Camshaft Locking Tool | for Fiat, Lancia 1.4 12V

- for locking of camshafts when setting the engine timing
- to be used as OEM 1860899000

suitable for the following models:

- Fiat Bravo, Brava, Lancia Y10 1.4 12V
- engine codes: 182A3.000, 182A5.000

Item #		1 / 6
9225		



Camshaft Locking Tool Set | for Fiat, Lancia 1.8l 115 HP

- for checking / adjusting the engine timing
- to be used as OEM 1860875000

suitable for the following models:

- Fiat Bravo/Brava/Marea 1800 16V 115 HP
- Lancia Delta/Dedra 1800 16V 115 HP
- camshaft alignment tool for inlet cam 2nd cylinder
- camshaft alignment tool for inlet cam 3rd cylinder

Item #		1 / 6
9261		



Camshaft Locking Tool Set | for Fiat, Lancia, Alfa Romeo 1.8l 130 HP

- for checking / adjusting the engine timing
- to be used as OEM 1860847000

suitable for the following models:

- Fiat / Lancia / Alfa Romeo 1.8L 16V 130 HP
- camshaft locking tool for inlet cam cylinder 2
- camshaft locking tool for outlet cam cylinder 3

Item #		1 / 6
9262		



Camshaft Locking Tool Set | for Fiat 2.0l 20V

- for checking / adjusting the engine timing
- to be used as OEM 1860892000

suitable for the following models:

- Fiat Bravo/Brava/Marea 2.0L 20V 5-cylinder
- camshaft locking tool for inlet cam cylinder 3
- camshaft locking tool for outlet cam cylinder 2

Item #		1 / 6
9263		

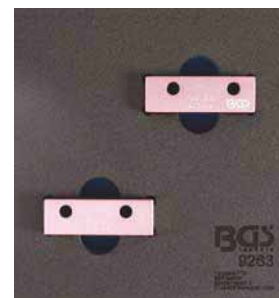

Camshaft Locking Tool Set | for Fiat, Lancia 1.8l 16V

- for checking / adjusting the engine timing
- to be used as OEM 1870697000

suitable for the following models:

- Fiat Coupe / Barchetta / Punto (HJT) / Barchetta (HJT)
- Lancia Delta / Dedra Step"A"
- camshaft locking tool for inlet cam cylinder 2
- camshaft locking tool for outlet cam cylinder 3

Item #	
9267	



Camshaft Locking Tool Set | for Lancia K 2.0l 20V

- for checking / adjusting the engine timing
- to be used as OEM 1860961000

suitable for the following models:

- Lancia 2.0L 20V 5-cylinder VIS (manufactured after 1996)
- camshaft locking tool for inlet cam cylinder 2
- camshaft locking tool for outlet cam cylinder 3

Item #	
9226	



Camshaft Locking Tool Set | for Lancia 2.4 20V

- for checking / adjusting the engine timing
- to be used as OEM 1860818000

suitable for the following models:

- Lancia 2.4L 20V 5-cylinder (manufactured before 1996)
- camshaft locking tool for inlet cam cylinder 3
- camshaft locking tool for outlet cam cylinder 2

Item #	
9229	



Camshaft Locking Tool Set | for Lancia 2.0 VIS 4 Cylinder

- for checking / adjusting the engine timing
- to be used as OEM 1860819000

suitable for the following models:

- Lancia Kappa 2.0, 2.4 20V (1994-1997)
- camshaft locking tool for inlet cam cylinder 3
- camshaft locking tool for outlet cam cylinder 2

Item #	
9228	



Engine Timing Tool Set | for Fiat, Lancia

- for locking the flywheel and crankshaft
- adjusting the crankshaft
- adjusting the camshaft
- locking the fuel injection pump shaft
- pulling off the crankshaft pulley
- tensioning of the timing belt
- to be used as OEM 1 860 847 000, 1 860 875 000, 1 870 697 000, 1 860 895 000, 1 895 879 000, 1 860 898 000, 1 860 992 000, 1 860 992 000, 1 863 000 (8mm), 1 860 771 000, 1 860 161 000, 1 860 874 000, 1 860 874 000, 1 860 876 000, 1 860 845 000, 1 860 876 000, 1 860 965 000, 1 860 901 000, 1 860 905 010, 1 860 987 000, 1 860 985 000

Item #	Description
8148	Engine Timing Tool Set for Fiat, Lancia
8148-13	Gauge Adaptor for BGS 8148
8159-16	Tensioner Wrench for Fiat
8159-17	Gauge to determine the Piston height
8159-6	Camshaft Locking Tool for Fiat, Alfa, Lancia 2 pcs.



Engine Timing Tool Set | for Fiat, Ford, Opel, Suzuki 1.3l Diesel

- for checking and adjusting the engine timing

suitable for the following models:

- Fiat
 - Punto 1.3 JTD Multi-Jet 188A9.000, manufactured between 2003 and 2007
 - Panda 1.3 JTD Multi-Jet 169A1.000, 188A8.000, manufactured between 2003 and 2009
 - Idea 1.3 JTD Multi-Jet 199A3.000, 188A9.000, manufactured between 2004 and 2006
 - Doblo 1.3 JTD Multi-Jet 188A9.000, manufactured between 2004 and 2006
 - Doblo Cargo 1.3 JTD 188A9.000, manufactured between 2004 and 2006
- Opel/Vauxhall:
 - Agila 1.3 CDTi Z13DT, manufactured between 2003 and 2008
 - Corsa-C 1.3 CDTi Z13DT, manufactured between 2003 and 2007
 - Combo-C 1.3 CDTi Z13DT, manufactured between 2003 and 2009
 - Corsa-D 1.3 CDTi Z13DTH, Z13DTJ, manufactured between 2006 and 2009
 - Astra-H 1.3 CDTi Z13DTH, manufactured between 2004 and 2009
 - Tigre-B 1.3 CDTi Z13DT, manufactured between 2004 and 2009
 - Meriva 1.3 CDTi Z13DT, Z13DTJ, manufactured between 2004 and 2009
- Suzuki:
 - Ingis 1.3 CDTi Z13DT, manufactured between 2003 and 2009
 - Wagon 1.3 CDTi Z13DT, manufactured between 2003 and 2009
 - Swift 1.3 CDTi Z13DT, manufactured between 2003 and 2010
- Ford Ka 1.3 TDCi
- counterholding tool for crankshaft pulley, to be used as Fiat Ford OEM 1871000200 - Ford OEM 303-1469 - Opel/Vauxhall OEM KM-662-C
- crankshaft adjustment tool, to be used as Opel / Vauxhall OEM EN 46785 OEM KM 955, Suzuki 09912-38300
- camshaft adjustment tool, to be used as Fiat OEM 1871000900 / 1860985000 - Ford OEM 303-1472, Opel (Vauxhall) OEM EN 46781 - Suzuki OEM 09917-68610
- chain tensioning lever, to be used as Fiat OEM 1870900400
- crankshaft locking tool, to be used as Fiat OEM 1870900300 - Ford OEM 303-1468
- camshaft adjustment tool, Fiat 8 mm

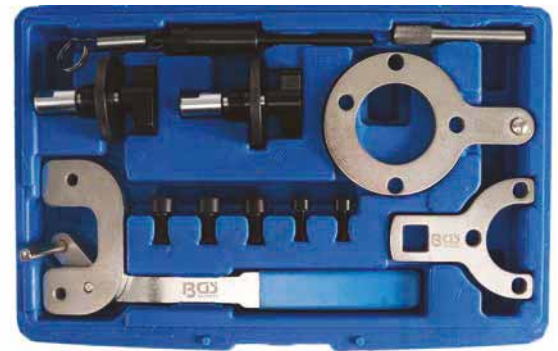

Item #

8669

Engine Timing Tool Set | for Fiat 1.2 16V

- for checking and adjusting the engine timing
- suitable for the following models:
 - Fiat 500 1.2 (2007) - Brava 1.2 - Bravo 1.2 16V (1995 - 2002) - Grande Punto 1.2, Idea 1.2, Idea 1.2 16V - Marea 1.2 , Marea Weekend, Marengo 1.2 - Palio Weekend 1.2 16V (1993 - 1999) - Punto 1.2 (1993 - 1999) - Punto Classic 1.2 16V (1999) - Stilo 1.2
 - Lancia Ypsilon 1.2 16V (1996 - 2003)
 - engine codes: 176B9.000, 169A4.000, 182B2.000, 188A5.000
- piston height adaptors (2 x), to be used as OEM 1860992000
- camshaft adjusting tools (2 x), to be used as OEM 1860985000
- tensioner pulley wrench, to be used as OEM 1860987000



Item #
8725

Engine Timing Tool Set | for Fiat, Peugeot, Citroën 1.8, 2.0 8V Petrol

- for checking the engine timing
- suitable for engine codes LFW, RFU, RGX, RFW
- crankshaft locking tool 6 mm
- camshaft locking tool 10 mm
- camshaft locking pins 2x
- timing belt tensioning tool
- to be used as OEM 0132Q, 0132QZ, 0132Z, 0132R, 1053AA, 1053AB, 1053ZY, 0153G, 4507TA, 4507TB, 5711TA, 7014TN, 9767.27, 7014TM, 0132X, 0132X1Z, 4507T, 4507TJ, 1860755000, 1860161000, KM955



Item #
8740



Engine Timing Tool Set | for Fiat 1.7, 1.9 Diesel

- for adjusting the engine timing on Fiat engines 176B3.000, 176A3.000, 176A5.000, 149B1.000, 160A6.000, 160A7.000, 160D1.000, 230A2.000, 230A3.000, 230A4.000, 280 A1.000
- suitable for Fiat models Punto 1.7D / TD, Tipo 1.9D, Ducato 1.9D / TD, Tempra 1.9TD with adjustable camshaft sprocket
- camshaft locking tool, to be used as OEM 1860932000
- camshaft locking tool, to be used as OEM 1860934000
- camshaft locking tool, to be used as OEM 1860931000
- crankshaft locking tool, to be used as OEM 1860933000

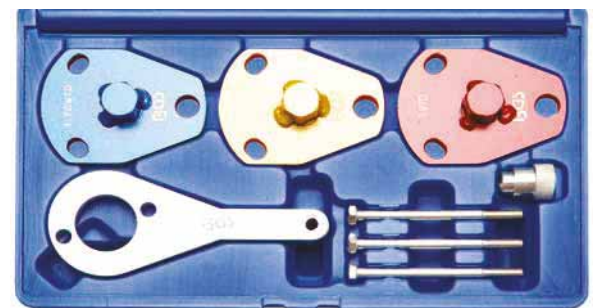

Item #
8741

Engine Timing Tool Set | for Alfa Romeo, Lancia, Fiat 0.9

- for adjusting the engine timing when e. g. replacing timing chain, cylinder head repairs, etc.

suitable for the following models with the engine code 312A2000:

- Alfa Romeo Mito 2012
- Fiat 500 2010
- Fiat Panda 2012
- Fiat Punto 2012
- Lancia Ypsilon 2012
- crankshaft locking pin to be used as OEM 2000035300
- belt pulley locking pin to be used as OEM 2000035200
- camshaft locking plate to be used as OEM 2000035100

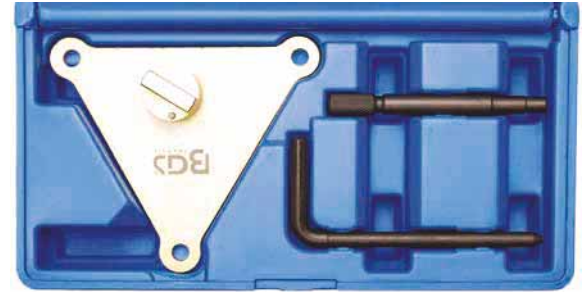

Item #
8815

Engine Timing Tool Set | for Fiat, Opel, Alfa 1.9/2.4l 16V Diesel

- for adjusting the engine timing when e.g. changing the timing belt, cylinder head repairs, etc.

suitable for the following engines:

- Opel 1.9 CDTi Z19DT, Z19DTH, Z19DTJ
- Alfa-Romeo 1.9 and 2.4 L diesel with engine codes: 323.02, 371.01, 342.02, 325.01, 362.02, 182B9.000, 937A2.000, 937A3.000, 192A5.000, 192B1.000, 937A4.000, 937A5.000, 939A2.000, 939A1.000, 939A7.000, 939A8.000, 839A6.000, 841C.000
- Fiat 1.9 and 2.4 L diesel with engine codes: 182B4.000, 182B9.000, 185A6.000, 186A6.000, 186A8.000, 186A9.000, 188A2.000, 188A7.000, 188B2.000, 192A1.000, 192A3.000, 192A5.000, 192A8.000, 192A9.000, 192B4.000, 192B5.000, 198A2.000, 198A3.000, 198A6.000, 199A5.000, 223A7.000, 937A5.000, 939A1.000, 939A2.000, 939A3.000, 939A7.000
- crankshaft locking tool to be used as OEM Opel EN-46788 / Fiat 1.860.905.000 / 1.860.905.010
- flywheel locking tool to be used as OEM Fiat 1.860.898.000
- camshaft locking tool to be used as OEM Opel EN-46789 / Fiat 1.870.896.900
- locking pin Ø 3.7 mm x 70 mm to be used as OEM Opel KM 6130 / KM 6349



Item #
62665

Engine Timing Tool Set | for Fiat, Alfa Romeo, Lancia 1.2 16V, 1.4 16V, T-Jet

- for adjusting the engine timing during timing belt replacement, cylinder head repair, replacement of the cylinder head gasket, etc.
- suitable for Alfa Romeo, Fiat and Lancia 1.2 16V / 1.4 16v / 1.4 T-Jet
- engine codes e. g. 169A3000, 179B9000, 182B2000, 188A5000, 192B2000, 198A1000, 198A4000, 199A6000, 199A8000, 843A1000
- crankshaft locking tool (with screws M6x30 and 3 pcs. M8x16), to be used as OEM 2.000.004.500
- camshaft adjusting tool (1 pair), to be used as OEM 1.860.985.000
- adjusting tool for piston height, to be used as OEM 1.860.992.000
- adjusting tool for timing belt tensioner, to be used as OEM 1.860.987.000
- locking tool for camshaft sprockets (with screw M8x30), to be used as OEM 2.000.015.800



Item #	Description
62666	Engine Timing Tool Set for Fiat, Alfa Romeo, Lancia 1.2 16V, 1.4 16V, T-Jet
62666-1	Crankshaft Locking Tool for Fiat, Alfa, Lancia

Engine Timing Tool Set | for Fiat 1.4 12V

- for checking and setting the engine timing

suitable for the following Fiat models:

- Brava
- Bravo
- Marea Weekend
- Lancia Ypsilon
- engine codes: 182 A3.000, 182 A5.000
- camshaft alignment tool, to be used as OEM 1860 899 000
- crankshaft alignment tool, to be used as OEM 1860 901 000
- bolts for crankshaft adjusting tool, to be used as OEM 1 860 901 000



Item #
9213

Engine Timing Tool Set | for Ford | 4 pcs.

- suitable for fuel engines 1.25 L, 1.4 L, 1.6 L, 1.8 L, 2.0 L, e. g. for Zetec, Zetec SE, etc.
- crankshaft timing tool to be used as OEM 303-748, 999-7152, 21-259, 303-574, 21-163, 303-620, 999-7201, 49J E02 024, 303-507, 21-210
- camshaft alignment plate to be used as OEM 303-376, 303-376B, 999-7151



Item #	Description
8215	Engine Timing Tool Set for Ford 4 pcs.
8215-1	Camshaft Locking Tool for Ford

Engine Timing Tool Set | for Ford

contains tools for:

- locking the flywheel
- locking the crankshaft, camshaft, pump shaft
- locking the fuel injection pump shaft
- extracting the crankshaft pulley
- tensioning the timing belt
- includes adjusting gauge for camshaft, crankshaft, pump shaft
- complete classification chart for vehicle types and scope of application included
- suitable for the following Ford engines:
 - 1.4, 1.6 16V, 1.7, 1.8 16V, 2.0 16V (also Zetec)
 - 1.4, 1.6, 1.8, 1.9 D/TD/TDCi
- to be used as OEM 21-162, 21-162B, 303-367, 303-376, 23-059, 310-085, 21-168, 303-393, 23-020, 23-047, 23-020, 21-163, 303-620, 23-019, 21-210, 303-507, 21-251, 303-698, 21-262, 303-734, 23-029, 303-1061, 23-058, 310-084, 21-105, 21-262, 303-734, 21-168, 303-393, 21-263, 303-735 / Mazda 49JE01061 / Audi 3359, T10008, T10050, 2065A / Seat 3359, T10008, T10050, 2065A / Skoda 3359, T10008, T10050, 2065A / Volkswagen 3359, T10008, T10050, 2065A

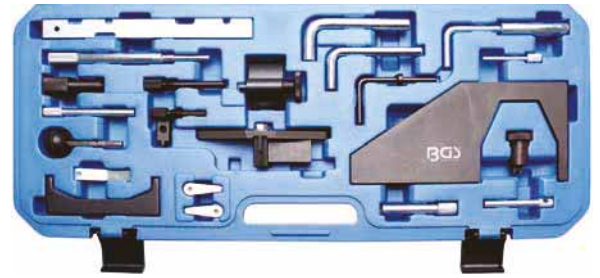

Item #	Description
8156-2	Crankshaft Locking Tool for Ford for BGS 8156
8156	Engine Timing Tool Set for Ford
8156-3	Injection Pump Locking Tool for Ford for BGS 8156 15.4 mm
8156-4	Crankshaft Locking Tool for Ford for BGS 8156
8156-5	Crankshaft Locking Tool for Ford for BGS 8156
8156-6	Locking Pin for Ford for BGS 8156 8.2 mm
8156-12	Feeler Gauge for Ford for BGS 8156
8156-14	Crankshaft Locking Tool for Ford for BGS 8156 12.7 mm
8156-17	Camshaft Holding Tool for Ford for BGS 8156
8156-18	Hand Wheel for Ford for BGS 8156
8156-19	Crankshaft Locking Tool for Ford for BGS 8156

Engine Timing Tool Set | for Ford Focus | 5 pcs.

- for replacing the cam belt on Ford Focus 1.6 TI-VCT engines, engine code HXDA (2003-2007) and 2.0 TDCi with engines codes G6DA, G6DB, G6DC 2003-2007
- camshaft sprocket holding tool to be used as OEM 303-1097
- tensioner pulley locking pin to be used as OEM 303-1054
- flywheel timing pin to be used as OEM 303-1059, 303-1270, 0188X, 999-7121
- crankshaft timing pin to be used as OEM 303-748, 999-7152, 21-259
- camshaft sprocket locking tool to be used as OEM 303-735, 999 7122, 0187B, 0189B, 0132AJ1, 21-263, 0188M, MOT 1430, 303-1277, 0194B



Item #
8218

Engine Timing

Engine Timing Tool Set | for Ford 2.0, 2.4 TDCi | TDDi

- for locking or positioning of the cam, injection pump and crankshaft
- needed for chain changes, engine repairs and work on the injection pump
- suitable for Ford 2.0, 2.4 16V TDCi and TDCi engines, installed in e. g. Mondeo, Transit (2001 - 2004) etc.
- for engine code FMBA/B, D5BA, ABFA, D3FA, F3FA, D2FA, D4FA, F4FA
- to be used as OEM 303-675 (21-234), 303-681 (21-240) and 303-698 (21-251)



Item #
8317

Engine Timing Tool Set | for Fiat, Ford, Lancia 1.2, 1.4 8V

- facilitates changing of the timing belt and allows checking of the engine timing on following cars:
 - Fiat 500 (07-12), Doblo/Cargo (05-10), Grande Punto (07-12), Idea (04-12), Linea (07-11), Panda EVO2, Punto EVO (09-12)
 - Lancia Ypsilon (06-11), Musa (05-12)
 - Ford Ka (09-12)
- with engines:
 - Fiat 1.2/1.2 Dualogic, 169A4.000, 188A4.000 (only EVO2), 199A4.0001.4/1.4 Bi-Fuel LPG / 1.4 Natural power CNG, 199A7.000, 350A1.000
 - Lancia 1.4/1.4 Bi-Fuel LPG, 350A1.000
 - Ford 1.2 Duratec, 169A4.000 (FP4)
- crankshaft locking tool, to be used as OEM 2.000.004.500 on Fiat/Lancia and OEM 303-1480 on Ford
- camshaft setting tool, to be used as OEM 2.000.004.400 on Fiat/Lancia and OEM 303-1479 on Ford
- camshaft sprocket locking tool, to be used as OEM 2.000.004.200 on Fiat/Lancia and OEM 303-1477 on Ford
- camshaft cover aligner, to be used as OEM 2.000.004.300 on Fiat/Lancia and OEM 303-1478 on Ford
- tensioner adjuster, to be used as OEM 1.860.987.000 on Fiat/Lancia



Item #
8578

Engine Timing Tool Set | for Ford 2.0 Ecoboost

- for adjusting the engine timing on chain driven 2.0L petrol direct injection engines with variable valve timing
- installed in the Galaxy / Mondeo / S-MAX / Focus models
- engine codes TNWA / TNBA / TPWA / MGDA / XQDA
- crankshaft locking tool, to be used as OEM 303-748
- camshaft alignment plate (up to 05.2011), to be used as OEM 303-1504
- camshaft alignment plate (after 05.2011), to be used as OEM 303-1565
- alignment tool for crankshaft position sensor, to be used as OEM 303-1521
- 2.5 mm tensioner locking pin

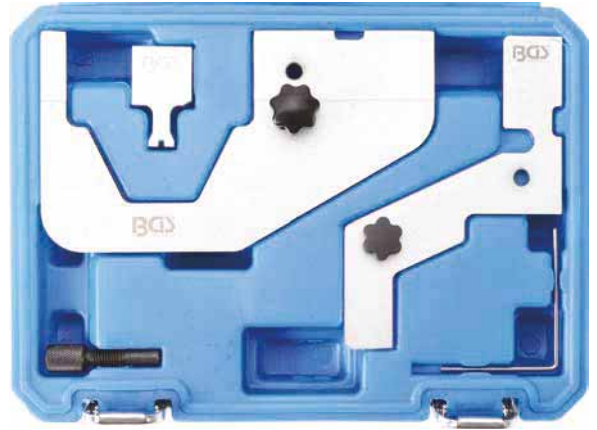

Item #
8874

Crankshaft Locking Tool | for Ford Transit 2.2

- suitable for Ford Transit 2.2 manufactured before 2006
- for locking crankshaft and flywheel
- allows the TDC sensor position to be set after working on cam chain drive system
- crankshaft locking tool to be used as OEM 303-1587
- flywheel locking tool to be used as OEM 21-251 / 303-698
- timing pump locking pin to be used as OEM 0188H / 1860965000



Item #
8896

Chain Housing Cover Alignment & Pump Sprocket Removal Tool Set | for Ford 1.8 TDDi / TDCi

- for alignment of chain housing cover and for removing of high pressure pump sprocket
- during works on high pressure pump chain, for example
- tools are complementary for engine timing tool set BGS 8156

suitable for the following models:

- Focus 1.8 TDCi (2004 - 2011)
 - engine codes: KKDA, KKDB
- C-Max 1.8 TDCi (2003 - 2007)
 - engine codes: KKDA, BHPA, HCPA
- Tourneo Connect 1.8 TDCi (2002 - 2013)
 - engine codes: HCPA, HCPB (2002 - 2006), RWPA, R2PA, P7PA, P9PA, R3PA (2006-2013), P9PB, RWPC (2009 - 2013)
- Tourneo Connect 1.8 TDdi (2002 - 2006)
 - engine code: BHPA
- Mondeo 1.8 TDCi (2007 - 2010)
 - engine codes: FFBA, QYBA, KHBA
- Mondeo 1.8 TDCi ECOnetic (2008 - 2010)
 - engine code: KHBA
- Transit Connect 1.8 TDCi (2002 - 2013)
 - engine codes: HCPA, HCPB (2002 - 2006), RWPA, P7PA, R2PA, P9PA, R3PA (2006 - 2013), P9PB, RWPC (2009 - 2013)
- Transit Connect 1.8 TDdi (2002 - 2006)
 - engine code: BHPA
- chain housing cover alignment tool, to be used as OEM 303-652 (21-230)
- high pressure pump sprocket disassembly tool, to be used as OEM 303-095 (23-067)



Item #		1 / 6
9387		

Engine Timing Tool Set | for Ford 1.0, 3-cylinder EcoBoost

- for checking / adjusting the engine timing
- suitable for Ford engines 1.0L 3-cylinder, with 74 KW / 88 KW / 92 KW / 103 KW, installed on e.g. Fiesta / Focus / B-MAX / EcoSport
- Engine codes M1DD / M1JA / M1JC / M1JE / M1JHM1JJ / M1DA / M2DA / M2DB / M2DC / SFDBSFJA / SFJB / SFJC / SFJD /
- camshaft fixing tool, to be used as OEM 303-1605 (x 2)
- camshaft adjuster setting tool, to be used as OEM 303-1606 (x 2)
- crankshaft locking pin, to be used as OEM 303-1604
- flywheel locking tool, to be used as OEM 303-1602, 303-393A, 21-168
- idler fixing pin, to be used as OEM 303-1054



Item #		1 / 3
9072		

Belt tensioner Wrench | Ford Duratorq Engines

- suitable for Ford Duratorq 2.0 / 2.2 (TDDI / TDCI) engine codes: D5BA / D6BA / HJBA / HJBC / FMBA / N7BA / QJBB / QJBA



Item #
8533

Crankshaft Locking Pin | for Ford Zetec, Duratec Engines

- suitable for Ford Zetec SE and Duratec 1.25, 1.4, 1.6l engines, installed in Fiesta, Fusion and Focus
- to be used as Ford OEM 303-748, 21-259, Mazda OEM 49J E02 024, Volvo OEM 999 7201



Item #
8671



Engine Timing Tool Set | for Ford Duratorq 2.0, 2.4 Diesel

- is needed when working on timing chain, cylinder head, etc.
- includes flywheel, pump, camshaft and chain tensioner locking pins to be used as OEM 21-234, 21-251
- suitable for Ford Mondeo and Transit 2.0 I / 2.4 I Duratorq 16V (TDDi and TDCi), engine codes ABFA, D2FA, D3FA, D5BA, D6BA, D0FA, FIFA, F3FA, F4FA, FMBA/B, FXFA, H9FA, H9FB, HJBA/B, HJBC, HJBE, JXFA, N7BA/B, PHFA, SDBA



Item #
8672



Engine Timing Tool Set | for Ford TDCi, PSA Hdi, Mazda D 1.4, 1.6

- for setting the engine timing when replacing the cylinder head gasket, camshaft, etc.

suitable for the following engines:

- Citroen 1.4Hdi DV4TD (8HT/8HW/8HX/8HZ), 1.4Hdi DV4TED4 (8HV/8HY), 1.6Hdi DV6TED4 (9HY/9HZ), 1.6Hdi DV6ATED4 (9HW/9HX), 1.6Hdi DV6UTED4(9HU)
- Mazda 1.4CiTD F6JA, F6JB 1.6CiTD Y6
- Peugeot 1.4Hdi DV4TD (8HT/8HW/8HX/8HZ), 1.4Hdi DV4TED4 (8HV/8HY), 1.6Hdi DV6TED4 (9HY/9HZ), 1.6Hdi DV6ATED4 (9HW/9HX), 1.6Hdi DV6UTED4(9HU)
- Ford 1.4TDCi F6JA, F6JB, F6JC, F6JD 1.6TDCi G8DA, G8DB, HHDA 1.6TDCi HHDB, HHJA, HHJB, HHJD
- Volvo 1.6D D4164T
- flywheel locking bolt, to be used as OEM PSA 0194-C, Ford 303-734 (21-262), Volvo 999-7169, Mazda 49 JE02 020
- crankshaft & high pressure pump locking pin, 2 pcs., to be used as OEM PSA 0194-A, Ford 303-732 (21-260), Volvo 999-7233, Mazda 49 JE02 018
- camshaft locking pin, to be used as OEM PSA 0194-B, Ford 303-735 (21-263), Volvo 999-7122, Mazda 49 JE02 021



Item #
8673



Diesel Pump Sprocket Puller | for Ford

- for pulling off the diesel pump sprocket
- suitable for Ford Transit 2.2 TDCI engine (Puma) as of year 2011

Item #
8974



Camshaft Sprocket, Pump Wheel Extractor | for Ford

- can also be used for pulling off the impeller
- suitable for the following engine codes: F8M, F8Q, J8S, S8U, S9U
- 90 x 65 mm

Item #
66350



Engine Timing Tool Set | for Land Rover, Jaguar V8

- for adjusting and checking the engine timing
- required for e.g. working on valve drive and renewing the cylinder head gasket

suitable for 3.2, 3.5, 4.0, 4.2, 4.4L engines in the following models:

- Jaguar XJ8 (97-09), engine AJ26 AC, BC, LC, 1B, 5G, SB
- Jaguar XJR (97-09), engine AJ27 KB, CC, MA, 2B, 9G, TB
- Jaguar S-Type (99-08), engine AJ28 KC, CE, MB, 3B, HB, PC
- Jaguar XF (08-09), engine AJ34 3.5, DC, NB, 1G, HG
- Jaguar XK8 (97-09), engine RB, EC, NC
- Jaguar XKR (98-09), engine GB, PA
- Range Rover (new) (06-09), 4.2L engine (428 HP)
- Range Rover (05-09), 4.2L engine (428 HP)
- Land Rover Discovery III (05-09)
- flywheel locking pin (silver), to be used as OEM 303-531
- flywheel locking pin (gold), to be used as OEM 303-645
- 2 camshaft setting plates, to be used as OEM 303-530
- camshaft gear holding tool, to be used as OEM 303-532
- 2 tensioner wedges, to be used as 303-533
- primary tensioner locking pin, to be used as OEM T40011
- setting tool for VVT unit, to be used as OEM 303-654
- tensioner depress pin



Item #		
9006		

Engine Timing Tool Set | for Jaguar, Land Rover 5.0 V8

- for adjusting and checking the engine timing
- required for working on valve drive and renewing the cylinder head gasket
- suitable for following models with 5L V8 engine: X150–XK(10MY), X250–XF(10MY), X351–XJ(10MY)
- camshaft alignment tools, to be used as OEM 303-1445
- crankshaft timing pin, to be used as OEM 303-1447
- flywheel locking tool, to be used as OEM 303-1448
- camshaft turning tool, to be used as OEM 303-1452
- timing chain pre-tensioning tool, to be used as OEM 303-1482



Item #		
9009		

Engine Timing Tool Set | for Jaguar, Land Rover, Ford, Citroën 2.0, 2.2, 2.4, 3.2 Diesel

- for adjusting and checking the engine timing
- required for e. g. working on the valve drive and renewing the cylinder head gasket

for the following models:

- Ford Mondeo (2000 - 2007), Transit (2000 - 2011)
- Citroen Relay (2006 - 2011), Jumper III
- Fiat Ducato (2006 - 2011)
- Jaguar X-Type (2001 - 2010)
- Land Rover Defender (2007 - 2011)
- Peugeot Boxer III (2006 - 2011)
- LDV Convoy (2002 - 2006)
- with DURATORQ (PUMA) diesel engines
- 2.0L engine codes: ABFA, D3FA, D5BA, D6BA, F3FA, F1FA, FMBA, HJBA, HJBB, HJBC, HJBE, N7BA, N7BB
- 2.2l (chain driven high pressure pump), engine codes: QJBA (BG), QJBB, QJBC, QJBD
- 2.2l (camshaft driven high pressure pump), engine codes: 4HM, 4HU, 4HV, P8FA, P22DTE, QVFA, QWFA
- 2.4L with engine codes: 244DT, DOFA, D2FA, D2FB, D4FA, F4FA,FXFA, H9FA, H9FB, HE FA, HFFA, JXFA, PHFA, ZSD 424
- 3.2l with engine code: SAFA (only engine timing)
- engine cover aligner, to be used as OEM 303-682
- engine cover / crankshaft seal tool, to be used as OEM 303-679A
- high pressure pump sprocket retaining tool, to be used as OEM 303-1151
- high pressure pump removal tool, to be used as OEM 303-249
- flywheel locking pin, to be used as OEM 303-675
- flywheel locking pin, to be used as OEM 303-698
- 3-piece locking pin set, 6 mm
- tensioner locking pin, 2 mm



Item #		
9010		

Engine Timing Tool Set | for Land Rover, Jaguar 2.7

- for adjusting and checking the engine timing
- required for working on valve drive and renewing the cylinder head gasket

suitable for the following models:

- Jaguar S-Type TDVi (2004 - 2009)
- Land Rover TDV6 Discovery
- Range Rover Sport TDV6 (2004 - 2006)
- engine code 276DT
- flywheel locking tool (manual) to be used as OEM 303-1116
- flywheel locking tool (automatic) to be used as OEM 303-1117
- camshaft sprocket alignment tool, to be used as OEM 303-1132
- camshaft sprocket alignment pins, 2 pcs., to be used as OEM 303-1126 (PSA 0195H)



Item #		
9005		

Engine Timing Tool Set | for Jaguar, Land Rover 2.7, 3.0 TD V6

- for adjusting and checking the engine timing
- required for working on the valve drive and renewing the cylinder head gasket

suitable for the following models:

- Citroen C5 III (2007 - 2009), C6 (2005 - 2009)
- Jaguar S-Type (2004 - 2008), XF (2008 - 2012), XJ (2010 - 2012), XJ6 (2005 - 2010)
- Range Rover Sport (2005 - 2009)
- Peugeot 407 (2004 - 2009), 407 Coupe (2006 - 2009), 607 (2004 - 2011)
2.7TD V6 / TDVi (276DT) 2.7D HDi (DT17BTED4) (UHZ) 3.0D HDi (D20CTED4) (X8Z) 3.0D SD V6 / TD V6 (306DT) (AJ-V6D)
- flywheel locking tool (manual), to be used as OEM (Rover) 303-1116
- flywheel locking tool (automatic), to be used as OEM (Rover) 303-1117
- camshaft sprocket alignment tool, to be used as OEM (Rover) 303-1132
- camshaft sprocket alignment pins, 2 pcs., to be used as OEM (Rover) 303-1126, (PSA) 0195H
- coolant pump locking pin, to be used as OEM (PSA) 0195-C
- flywheel locking tool, to be used as OEM (PSA) 0195-K
- tooth belt holding clip, to be used as OEM (PSA) 0188-K



Engine Timing

Item #	
9008	

Camshaft Locking Tool | for Rover, MG

- suitable for Rover- and MG models
- length: 44.5 mm
- width: 33.5 mm
- height: 15 mm



Item #	
1764	

Timing Chain Mounting Tool Set | for Mercedes-Benz Engine 651 | 10 pcs.

- prevents skipping of chain and moving of camshaft sprockets when replacing the timing chain
- removing of camshaft sprockets is not required
- allows precise positioning

suitable for the following models:

- Mercedes-Benz engine OM 651 series
- timing chain guide tool, to be used as OEM 60831800
- camshaft locking tool, to be used as OEM 60831830
- crankshaft turning tool, to be used as OEM 60831810
- camshaft rotation key, to be used as OEM 60831820

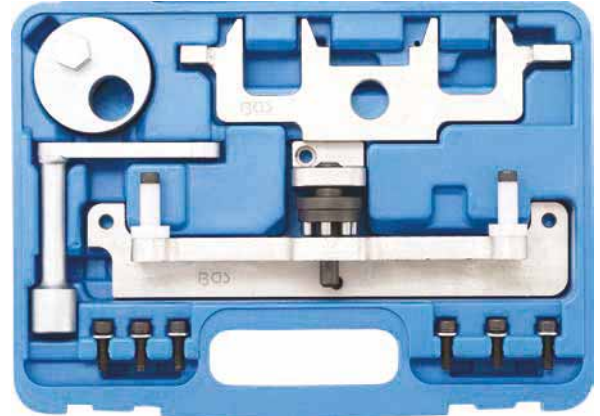

Item #
9378

Engine Timing Tool Set | for Mercedes-Benz M271

- is required when changing the timing chain
- suitable for the following Mercedes-Benz models: CLK 200K (W209), C 180K, C200K, C 230K (W203), C Sportcoupe C 160K, C 180K, C 200K, C 230K, E 200K (W211), SLK 200K (R171), C 180K (W204), CLC 180K, CLC 200K, C 180 CGI, C 200CGI, C 250CGI (W204), E 200CGI, E 250CGI (W212, C207)
- suitable for engines with the following engine codes: M271 E18ML (02-), DE18ML (03-05), E16ML (08-), DE18LA (09-)
- holding device for timing chain, to be used as OEM 271589014000
- camshaft locking tool, to be used as OEM 271589006100
- locating pin, to be used as OEM 271589001500
- timing chain tool, to be used as OEM 271589003100



Item #	Description
62623	Engine Timing Tool Set for Mercedes-Benz M271
62623-1	Tool Tray 1/3, empty for Item 62623

Engine Timing Tool Set | for Mercedes-Benz M112 + M113

- required for works on timing chain or adjusting the engine timing
- holds left & right side camshaft in adjusting position

suitable for the following models with M112 or M113 engine:

- Mercedes-Benz C-class 240/280 (202) (1997-)
- Mercedes-Benz C-class 240/320 (203) (2000-)
- Mercedes-Benz CL 500 (215) (1999-2006)
- Mercedes-Benz CLK 320/430 (208) (1997-2003)
- Mercedes-Benz CLK 240/320/500/55AMG (209) (2002-2006)
- Mercedes-Benz CLS 500/55AMG (219) (2004-2006)
- Mercedes-Benz E-class 240/280/320/430 (210) (1997-2002)
- Mercedes-Benz E-class 240/320/500/E55AMG (211) (2003-2006)
- Mercedes-Benz M-class ML320/350/430/500/55AMG (163) (1997-2005)
- Mercedes-Benz M-class 500 (164) (2005-2007)
- Mercedes-Benz S-class 280/320/350/430/500 (220) (1998-2005)
- Mercedes-Benz SL 280/320/500 (129) (1998-2002)
- Mercedes-Benz SL 350/500/55AMG (230) (2001-2008)
- Mercedes-Benz SLK 320K (170) (2000-2004)
- Mercedes-Benz SLK 55AMG (171) (2004-2010)
- Mercedes-Benz R-class 500 (2006-2007)
- Mercedes-Benz Viano 3.0/3.2/3.5 (2003-2008)
- Mercedes-Benz Vito 123 (639) (2004-2008)
- Chrysler Crossfire (SRT-6) (2003-2007)
- camshaft locking tool (right-side), to be used as OEM 112589003200
- camshaft locking tool (left-side), to be used as OEM 112589013200
- camshaft rotation key, to be used as OEM 112589000100



Engine Timing

Item #		
9215		

Engine Timing Tool Set | for Mercedes-Benz M270, M274, M133

- for setting and checking the engine timing
- allows holding down and fixing of the camshaft

suitable for the following models:

- Mercedes-Benz A-class (W176) as of 2012, model A180 / A200
- Mercedes-Benz B-class (W246) as of 2011, model B180 / B200
- to be used as OEM 270589006100

Item #
62628



Engine Timing Tool Set | for Mercedes-Benz M276, M157, M278 | 12 pcs.

- for adjusting the camshaft in the adjustment position

suitable for the following Mercedes-Benz models:

- CL 500 / 63 AMG (C 216) 2010–2013
- S 500 / 63 AMG (C 217) as of 2014
- CLS 300 (C 218) as of 2012
- E 300 / 350 / 400 (C/A 207) as of 2011
- CLS 350 / 400 / 500 / 63 AMG (C/X 218) 2011–2014
- SLK 350 (R 172) as of 2011
- SL 350 / 400 / 500 / 63 AMG (R 231) as of 2012
- S 500 PLUG-IN HYBRID (V 222) as of 2014
- ML 300 / 350 / 500 / 63 AMG (W 166) as of 2011
- C 400 (W 205) as of 2014
- E 400 HYBRID (W 212) as of 2012
- G 63 AMG (W 463) as of 2012
- E 300 / 350 / 400 / 500 / 63 AMG (W/S 212) as of 2011
- C 350 (W/S/C 204) as of 2011
- S 350 / 500 / 63 AMG (W/V 221) as of 2010
- S 400 / 63 AMG (W/V 222) as of 2013
- R 350 BlueEFFICIENCY (W/V 251) as of 2012
- GL 450 / 500 (X 166) as of 2012
- GLK 350 (X 204) as of 2011

- to be used as OEM 276589004000, 276589014000

Item #
62632



Engine Timing

Engine Timing Tool Set | for Mercedes-Benz OM651

- for adjusting the cam and crankshafts

suitable for the following Mercedes-Benz models:

- A-class W176 180/200/220 CDI
- B-class W246 200/220 CDI
- C-class W/S/C 204 180/200/220/250 CDI
- C-class W205 220/250
- CLA C117 200/220 CDI
- CLS C/X 218 220/250
- E-class W/S 212 200/220/250 CDI
- E-class C/A 207 220/250 CDI
- E-class W212 250/300 BlueTEC
- GLA X156 200/220 CDI
- GLK X 204 200/220/250 CDI
- ML W166 250
- SLK R172 250 CDI
- Sprinter W906 210/310/510/213/313 CDI
- Sprinter W906 513/216/316/416/516 CDI
- V-class W/V 447 200/220/250 CDI
- Viano W/V 639 2.0/2.2CDI
- Vito W/V 639 110/113/116 CDI
- camshaft alignment tool, to be used as OEM 65158 901 4000
- crankshaft rotating tool, to be used as OEM 65158, 900, 4000

Item #
62633



Diesel Pump Locking Pin | for Mercedes-Benz

- for locking Bosch inline diesel pumps in mounting position
- to be used as OEM 601 589 05 21 00
- suitable for Mercedes-Benz 200D / TD, 250D / TD, 300D / TD
- engines: 601.912 / 602.912 / 602.962 603.913 / 606.910 / 603.963



Item #
8905

Camshaft Holding Tool | for Mercedes-Benz 272 / 273 Engines

- for locking the left intake camshaft in place
- required when servicing the camshaft chain drive
- to be mounted with threaded bolt on cylinder head

suitable for the following models:

- Mercedes-Benz engines 272, 273
- C, CL, CLK, E350, E550, S400, S550, SL550, SLK280, SLK300, SLK350, G550, GL450, GL550, GLK350, ML350, ML450, ML550 und R350 models (2005-2012), 164.156, 164.172, 164.186, 164.195, 164.871, 164.886, 171.454, 171.456, 171.458, 203.052, 203.054, 203.056, 203.087, 203.092, 204.054, 204.056, 204.081, 204.087, 204.956, 204.987, 207.356, 207.372, 207.456, 207.472, 209.356, 209.372, 209.456, 209.472, 211.056, 211.072, 211.087, 211.090, 211.256, 211.287, 212.056, 212.072, 212.087, 212.090, 212.287, 216.371, 216.386, 219.372, 221.171, 221.186, 221.195, 230.471, 251.156, 251.165, 463.236, 463.237



Item #
8227

Engine Timing Tool Set | for Opel

- for adjusting timing when e. g. when replacing the cylinder head gasket

suitable for the following Opel engines:

- Z19DT - Z19DTH (OHC and DOHC) Vectra C, Signum 2004
- Z13DT Corsa, Combo 2004
- Z22SE Astra G, Vectra C, Zafira, Signum, Speedster Vx220 2000 - 2004
- petrol 1.0 12V - 1.2 - 1.4 16V (X10XE, Z10XE, Z10XEP, X12XE, Z12XE, Z14XEP) Corsa, Agila, Astra, Meriva
- diesel 2.0 - 2.2 Ecotec (X20DTL, X20DTH, X22DTH) Astra, Caravan, Zafira, Vectra, Omega, Sintra, Frontera
- partly suitable for identical engines from Renault and Saab

scope of delivery:

- water pump locking tool, to be used as OEM KM-J-43651
- flywheel locking tool, to be used as OEM 911
- crankshaft locking tool, to be used as OEM EN-46788, KM 952, KM 929, EN-46785
- camshaft locking tool, to be used as OEM KM 852, KM 853, KM 6148, EN-46789, KM 6340, EN-46781
- camshaft adjustment gauge, to be used as OEM KM 932, KM 953
- flywheel locking tool, to be used as OEM KM 6333
- camshaft alignment tool, to be used as OEM KM 933
- injection pump locking tool, to be used as OEM KM 927
- belt tensioner locking tool, to be used as OEM KM 955
- chain tensioner locking tool, to be used as OEM KM 955
- adjustment gauge for the camshaft speed sensor, to be used as OEM KM 954

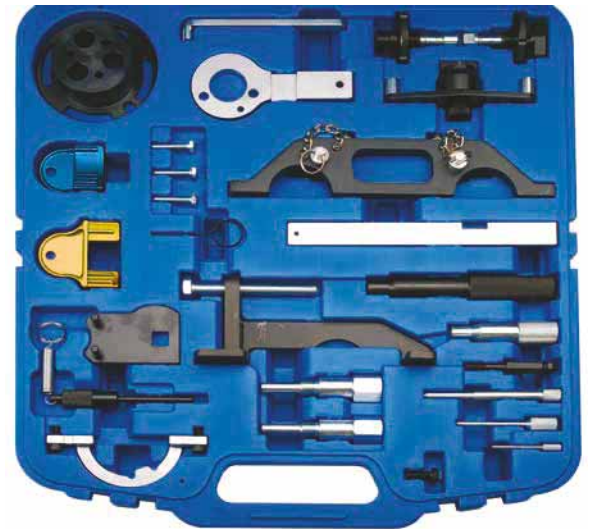

Engine Timing

Item #	Description
8151-1	Water Pump Locking Tool for Opel for BGS 8151
8151-2	Camshaft Locking Tool for Opel for BGS 8151
8151-3	Camshaft Locking Tool for Opel for BGS 8151
8151-6	Adjusting Ruler for Pick-Up Disk for Opel for BGS 8151
8151-8	Crankshaft Locking Tool for Opel for BGS 8151
8151-10	Locking Pin for Timing Chain Tensioner for Opel for BGS 8151
8151-12	Camshaft Locking Tool for Opel for BGS 8151
8151-17	Crankshaft Locking Tool for Opel for BGS 8151
8151-19	Addition for Crankshafts Locking Tool for Opel for BGS 8151
8151-22	Tensioner Locking Tool for Opel

Engine Timing Tool Set | for Opel Ecotec V6

- engine timing tool set for Opel/Vauxhall Ecotec V6 engines with multiple valve technique
- includes all necessary tools for clamping / locking the crankshaft and camshaft

suitable for the following Opel models:

- Calibra 2.5 V6 (1993 - 1998)
- Cavalier 2.5/2.6 V6 (1993 - 1995)
- Omega B 2.5/2.6 V6 (1994 - 2003)
- Omega B 3.0/3.2 V6 (1994 - 2003)
- Signum 3.2 V6 (2003 - 2005)
- Sinatra 3.0 V6 (1996 - 1999)
- Vectra A/B/C 2.5/2.6/3.2 V6 (1993 - 2005)
- crankshaft fixer tool, to be used as OEM KM-800-10
- camshaft setting gauge, to be used as OEM KM-800-20
- locking tool, to be used as OEM KM 800-30
- right camshaft locking tool, to be used as OEM KM-800-1
- left camshaft locking tool, to be used as OEM KM-800-2
- E-type socket, 12.5 mm (1/2") drive, E20 for return pulley
- combination spanner, angled, 30 mm



Item #
1779

Engine Timing Tool Set | for Opel 1.0, 1.2, 1.4

- for changing the timing chain and other jobs on the valve train, working on the intake and exhaust camshafts, fixing the crankshaft

suitable for the following Opel models:

- 1.0, 1.2, 1.4 (1997 - 2007)
- Agila (Z10XE, Z12XE, Z10XEP, Z12XEP)
- Corsa B (X10XE, X12XE)
- Astra G, H (X12XE, Z14XEL, Z14XEP)
- Corsa Combo C (X10XEP, X12XEP, Z14XEP)
- Meriva (Z14XEP)
- Tigra B (Z14XEP)
- Agila, Corsa 1.0 12V, 1.2 16V
- camshaft adjusting ruler
- crankshaft locking pin
- pulse disc adjusting tool
- timing chain tensioner pin

- to be used as OEM KM953, KM952, KM954, KM955

Item #
8303



Engine Timing Tool Set | for Opel 1.6, 1.8

- contains tools for locking the camshaft and crankshaft
 - suitable for 1.6 and 1.8L engines with timing belt, installed in Opel / Vauxhall, Chevrolet, Fiat, Alfa Romeo (2003-2012), e. g. Astra G / H, Corsa D, Insignia, Meriva, Signum, Vectra C, Zafira B (2003-2011)
 - suitable for Chevrolet Cruze, Orlando 1.4 - 1.6 - 1.8 and Fiat Croma, Alfa Romeo 159 with engines 939A4.000
 - camshaft locking tool
 - camshaft sprocket locking tool
 - locking pins
 - flywheel holding tool
- to be used as OEM tool KM-6628-A, 2000012000KM-6340, 2000012100KM-6333KM-6625, 2000012800KM-6349, KM 6130KM-911

Item #
8697



Engine Timing Tool Set | for Opel, GM 2.0, 2.2 Ecotec Diesel

- for setting the engine timing

suitable for the following models:

- Opel Vectra 2.0 turbo diesel
- Opel Sintra 2.2 turbo diesel
- Opel Zafira 2.0 turbo diesel
- Opel Frontera 2.2 turbo diesel
- Saab 9-3 2.2 turbo diesel
- engine code X20DTL X20DTH X22DTH Y22DTR
- adjustment wrench with bracket, to be used as OEM Opel KM933 / Saab 8395394
- injection pump timing pin to be used as OEM Opel KM927 / Saab 8395337
- crankshaft setting pin to be used as OEM Opel KM929 / Saab 8395352
- camshaft setting plate to be used as OEM Opel KM932 / Saab 8395386

Item #
8785



Engine Timing Tool Set | for Opel 1.2, 1.4

- for adjusting the engine timing

suitable for the following Opel/Vauxhall models:

- Adam 1.2 LWD 1.4 L2Z 1.4 LDD (2012)
- Ampera 1.4 LUU/A14XFL (2011)
- Astra-J 1.4 LDD/A14XER 1.4 LDD/A14XEL 1.4 LUJ/A14NET 1.4 LUJ/A14NEL 1.4 LUJ/A14NET (2009)
- Corsa-D 1.0 A10XEP 1.2 A12XEL 1.2 A12XER 1.4 A14XEL - 1.4 A14XER -1.2 A12XER 1.4 A14NEL (2009)
- Insignia 1.4 LUJ/A14NET (2011)
- Meriva-B 1.4 LDD/A14XER 1.4 LUJ/A14NET 1.4 LUH/A14NEL (2010)
- Mokka 1.4 LUJ/A14NET (2012)
- Zafira-C Tourer 1.4 LUJ/A14NEL 1.4 LUJ/A14NET (2011)
- Aveo 1.2 L2Q/A12XEL 1.2 LDC/A12XER 1.2 LWD/A12XEL 1.4 LDD/A14XEL 1.4 LDD/A14XER (2011)
- camshaft sensor disc setting tool to be used as OEM EN-49977-100
- intake camshaft adjusting tool to be used as OEM EN-49977-200
- camshaft sensor positioning tool to be used as OEM EN-49978
- chain tensioner pin 4 mm to be used as OEM KM-955-1
- belt tensioner pin 2.5 mm to be used as OEM KM-955-2
- 2 camshaft locking tools to be used as OEM KM-952 / 953-A



Engine Timing

Item #
8857

Engine Timing Tool Set | for Opel Vectra, Signum, Zafira

- for checking the timing on engine 2.2 l 16V engines with timing chain

suitable for the following Opel models:

- Astra G (2000 - 2006)
- Speedster (Vauxhall) VX220 (2000 - 2006)
- Vectra B, C (2000 - 2008)
- Signum (2003 - 2008)
- Zafira A, B (2000 - 2008)
- with engine codes: Z22SE, Z22YH
- camshaft locking tool, to be used as OEM KM-6148
- locking pin for chain tensioner, to be used as OEM KM-6077, Saab 8396392
- crankshaft counterholder, to be used as OEM Opel KM-J-38122-A, KM-956-1, Alfa 2192261000
- water pump locking tool, to be used as OEM Opel EN-43651, KM-J-43651, Alfa 2000012000

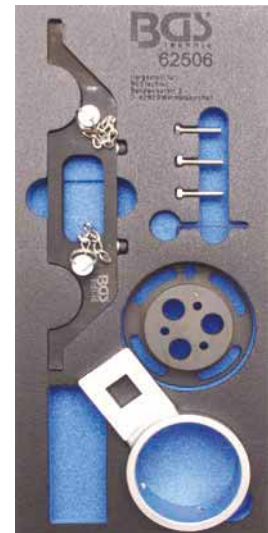

Item #
62506



Engine Timing Tool Set | for Opel (Vauxhall), Saab, Chevrolet 2.0l / 2.4l

- for adjusting engine timing when replacing timing chain, etc.
- suitable for 2.0 L & 2.4 L twin cam turbo charged petrol engines

suitable for the following models:

- Vauxhall (Opel) Astra, Insignia, Antara
- Chevrolet Captiva, HHR, Malibu
- Saab 9-5

with engines:

- OPC, OPC/VXR, Turbo, E85, Turbo T-Bi

engine codes:

- 2.0L > LHU, A20NFT, LTG, A20NHT, LDK, A20NHT
- 2.4L > A24XE, A24XF, LE5, LE9
- crankshaft pulley alignment tool, to be used as OEM EN-48585
- flywheel holding tool, to be used as OEM EN-43653, J43653
- tensioner retaining pin 2.5 mm, to be used as OEM EN-955-10, KM 955
- tensioner locating pin 4.0 mm, to be used as OEM EN-955-20, KM 955-20
- tension plunger resetting tool, to be used as OEM EN-45027-1, J-45027-1
- tension plunger holder, to be used as OEM J45027-2, EN45027-2, EN-45027
- camshaft locking tool (left side), to be used as OEM EN-49212, EN-49212-1
- camshaft locking tool (right side) to be used as OEM EN-49212, EN-49212-2
- camshaft adjuster holding tool, to be used as OEM EN-48953



Engine Timing

Item #		
9394		

Engine Timing Tool Set | for Opel, Chevrolet 2.0 CDI

- suitable for 2.0L common rail diesel engines with codes: Z20DM, Z20DMH, LLWZ20DMH, RA420, Z20SI, Z20S3, Z20S4, Z20S5
- for changing the timing belt and checking the engine timing
- holds camshaft and crankshaft in the correct position
- camshaft locking tool to be used as OEM EN-48245
- crankshaft locking tool to be used as OEM EN-48246



Item #
66202

Camshaft Locking Tool Set | for VAG, Ford, Opel, Saab

- all purpose set for many models

scope of delivery:

- camshaft locking tool for Opel Calibra, Omega, Sintra, Vectra -1.8 / 2.0, to be used as OEM KM-852, 18G1570
- camshaft locking tool for Opel Calibra, Omega, Sintra, Vectra -1.4 / 1.6, to be used as OEM KM-853
- locking tool for right camshaft for Saab 900, 900 -2.5 / 3.0, Opel Calibra, Sintra, Vectra -2.5/3.0, to be used as OEM KM-800-2
- locking tool for left camshaft for Saab 900, 900 -2.5 / 3.0, Opel Calibra, Sintra, Vectra -2.5/3.0, to be used as OEM KM-800-1
- crankshaft toothed belt wheel locking tool for TDI pump injection engines for VW, Skoda, Seat and Ford, to be used as VAG T10050
- flywheel locking tool for Citroen, Fiat and Peugeot, to be used as OEM 153A, 6012T, 9765.54
- flywheel holding tool for Isuzu 1.5 and 1.7 diesel, Opel 1.6 / 1.7 diesel engines, Opel 1.2 / 1.4 / 1.6 / 1.8 / 2.0 OHC petrol engines, to be used as OEM KM-517-B



Item #	Description
1775	Camshaft Locking Tool Set for VAG, Ford, Opel, Saab
1769	Camshaft Locking Tool for Opel Astra, Vectra, Omega, Frontera, Sintra
1770	Camshaft Locking Tool for Opel Astra, Corsa, Vectra
1775-LEER	Empty Case for BGS 1775

Water Pump Wheel Holder | for Opel Ecotec Engines

- suitable for Opel engines 2.2 L 16V / Z22SE
- holds the timing chain and gear in place while removing and installing the water pump on GM Ecotec engines
- holding the sprocket prevents loss of timing or damage to the engine
- special half-moon design allows easier access to the water pump gear bolts
- uses access cover bolts to hold the tool in place



Item #
8420

Camshaft Locking Tool | for Opel 1.6 / 1.8 I

- contains important tools for controlling and adjusting the engine timing
- suitable for Opel Astra G/H, Corsa D, Insignia, Meriva, Signum, Tigra, Vectra C, Zafira B (2003-2012) with engine codes A16LET, A16XER, Z16LEL, Z16LER, Z16LET, Z16XE, Z16XE1, Z16XEP, Z16XER, Z18XER, A18XER
- also suitable for Alfa Romeo 159, Fiat Croma with engine code 939A4.000
- camshaft locking tool, to be used as OEM KM-6340, EN-6340, 2000012100
- tensioner locking pin, to be used as OEM KM-6333, EN-6333



Item #
8721



Water Pump Adjusting Wrench | for Opel

- for turning the water pump, adjusting the timing belt tension
- suitable for Opel OHC petrol engines e. g. 1.2-1.3-1.4-1.6 l
- 12.5 mm (1/2") drive



Item #	Description
8971	Water Pump Adjusting Wrench for Opel 39 mm
8972	Water Pump Adjusting Wrench for Opel 41 mm
8973	Water Pump Adjusting Wrench for Opel 46 mm



Engine Timing Tool Set | for Peugeot, Citroen (PSA)

- for setting and checking the engine timing
- **suitable for the following car models:**
 - Citroën AX, Berlingo, BX, C5, C15, C25, Dispatch, Evasion, Jumper, Jumpy, Relay, Saxo, Synergie, Visa, Xsara, Xantia, XM, XJR, ZX, etc.
 - Peugeot 106, 205, 306, 405, 406, 605, 806, J5, Boxer, Expert, Partner, Solara, Talbot Expres, Talbot Horizon, etc.
 - PSA gasoline engines 1.9 - 1.1 - 1.4 - 1.6 - 1.8 - 1.9 - 2.0 - 1.6 - 1.8 - 2.0 - 2.2 16V (turbo and twin camshaft)
 - PSA diesel engines 1.4 - 1.5 - 1.7 - 1.8 - 1.9 - 2.1 - 2.5 D / TD / TDI - 1.4 - 1.6 - 2.0 - 2.2 HDI
- also suitable for identical engines in Fiat, Ford, Nissan, Renault, Rover, Toyota, etc.

Item #
8850

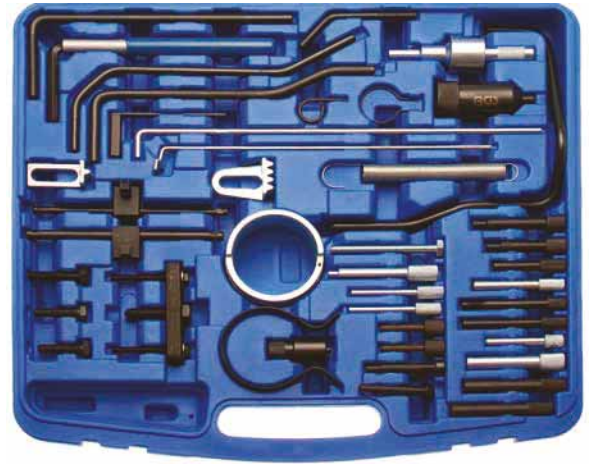

Engine Timing

Engine Timing Tool Set | for PSA

- for adjusting the engine timing while e. g. replacing the timing belt
- suitable for the following models:
 - Citroen, Peugeot 16V petrol engines, e.g. 1.8 / 2.0 16V with engine code EW (XU + TU) (incl. HPI engine) e.g. C5, 206, 306, and 406
 - Citroen, Fiat, Peugeot, Toyota 1,9D / 2,0D / 2,2D, engine code DW8 / DW10 / DW12 HDI (XUD+TUD)
 - also suitable for similar types of engine in Toyota and Fiat
- 8 camshaft locking pins, to be used as OEM 0189-L, 7014-TM, 5711-TC, 9041-TZ, 0132AJ2, 0188M, 4533-TAC2, 0132-AB, 4527-TS2, 5711-TD
- 2 camshaft / crankshaft locking pins, to be used as OEM 0132R, 4507-TB, 9767.27
- 1 crankshaft-ribbed drive puller, to be used as OEM 0188P/P2, 7015T
- 11 crankshaft locking pins, to be used as OEM 0153N, 0188D, 0188Y, 0288D, 7099-TM, 0118X, 0189-B, 0188-H, 0132AJ2, 4533TAC1, 0189-A, 0189AZ, 0118X, 0132Q, 5711-TA, 7017-TR, 0153G, 0153Y, 0153N, 0188D
- 2 flywheel locking tools, to be used as OEM 0132QZ, 4507-TA, 0189-C
- 2 flywheel locking tools, to be used as OEM 0134AF, 0188F, 9044-T, 0153A, 6012T, 9765-54, 9044
- 1 injection pump adjusting pins, to be used as OEM 4527-TS1
- 1 adjusting pin, to be used as OEM 0194B
- 1 drive belt retaining clip, to be used as OEM 0132.AK, 0153-AK, 0187-J, 0188-K, 4533-TAD
- 4 clamping tools, to be used as OEM 7017-TW, 188J2, 0178E, 5711TE, 0178J/J2, 4507-TJ, 0132X, 0132X1Z, 9767.89

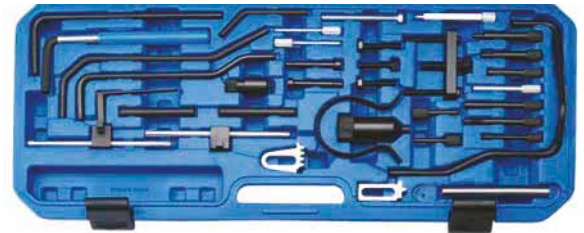

Item #	Description
8152	Engine Timing Tool Set for PSA
8152-19	Crankshaft Locking Tool for Peugeot, Citroën for BGS 8152
8152-30	Crankshaft Locking Tool for Peugeot, Citroën for BGS 8152

Engine Timing Tool Set | for Fiat, PSA

- for adjusting the engine timing
- suitable for Fiat engines: 2.2 JTD 4HV - 2.3 JTD F1AE0481D 120HP - 2.3 JTD F1AE0481D 127HP - 3.0 JTD
- suitable for PSA engines: Puma 22DT 4HV 100HP - Puma 22DT 4HV 120HP - F30DT

- crankshaft sealing ring installation and extraction tool to be used as OEM 2000016900, 303-679 / 303-679A, 0198D
- crankshaft locking tool, to be used as OEM 2000018700 303 -1587
- holding/turning tool for crankshaft, to be used as OEM 2000018400 / 2000010000, 303-1177
- flywheel locking tool, to be used as OEM 2000019200
- centring tool control casing, to be used as OEM 2000017000, 303/-682, 0198G
- crankshaft locking pin, to be used as OEM 2000017100, 303-698 / 21-251, 0198A
- camshaft locking pin, to be used as OEM 2000016500, 0198.B2
- holding and turning tool, to be used as OEM 1860815000, 0191-2K
- oil pump gauge, to be used as OEM 2000016700, 303-705 / 303-1093, 0198H
- water sensor tool, to be used as OEM 2000017300
- flywheel locking tool, to be used as OEM 1860846000
- crankshaft locking pin, to be used as OEM 99360615, 2000018200, 0191-2A
- camshaft locking tool, to be used as OEM 99360614, 0191-2B
- camshaft locking tool, to be used as OEM 1860617000, 2000018200

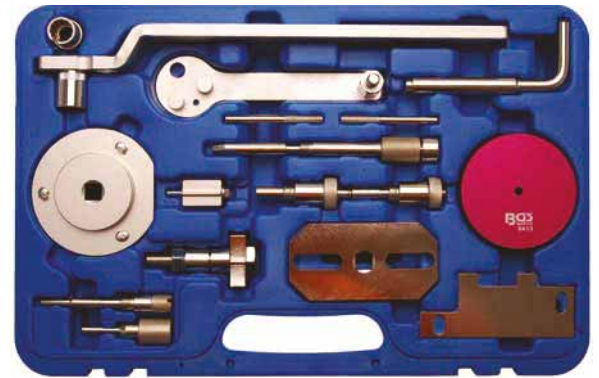

Engine Timing

Item #
8413

Engine Timing Tool Set | for PSA 1.8, 2.0 16V Petrol

- contains important tools for checking and adjusting the engine timing after replacing the timing belt and engine repairs

suitable for the following models:

- Citroen C5 1.8/2.0 HPi (2002 - 2005) Xsara 2.0 16V (2002 - 2005) Xsara, Picasso 1.8/2.0 16V (2002 - 2005)
- Peugeot 406 1.8 16V (2000 - 2004), 807 2.0 16V (2002 - 2005)
- engine codes 6FZ (EW7J4) FRN (EW10J4 / L4 / 5) RLZ (EW10D)

- tensioner locking tool, to be used as OEM 0189S2
- tool for tensioner, to be used as OEM 0178E, 5711TE, 178J/J2
- tool for tensioner, to be used as OEM 0188J2
- adjustment tool for clamping unit, to be used as OEM 0189S1
- locking pins, to be used as OEM 0132AB / 0194A / 0178D
- locking pin, to be used as OEM 0194B
- locking pin, to be used as OEM 0188M
- locking pin, to be used as OEM 0189B
- flywheel locking tool, to be used as OEM 0189R
- locking tool for tensioner, to be used as OEM 7017TR / 0153U
- adjustment tool for crankshaft wheel, to be used as OEM 0188AH

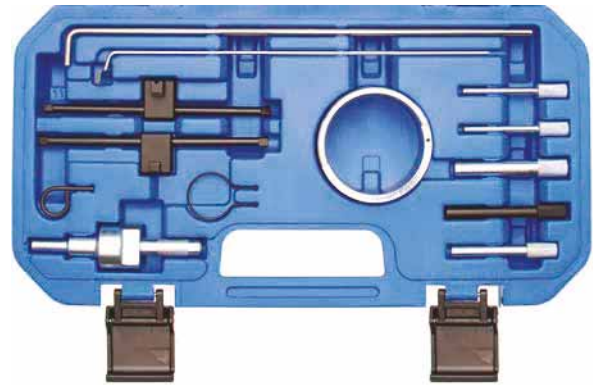

Item #
62622

Engine Timing Tool Set | for Peugeot, Citroën 1.0, 1.2 Vti

- for checking / adjusting the engine timing
- is required for working on the camshaft drive, renewing the cylinder head gasket, etc.

suitable for the following models with 1.0/1.2VTi engines:

- Peugeot 208 / 2008 (2012 to 2014)
- Citroen C3 (III)
- engine codes EBO (ZMZ), EB2 (HMZ)
- flywheel locking tool, to be used as OEM 0109-2B
- camshaft adjustment tool, to be used as OEM 0109-2A

Item #
8978



Engine Timing Tool Set | for Fiat Ducato, Peugeot Boxer, Citroën Jumper 2.3 D JTD, 3.0 JTD, HDi

suitable for the following models:

- Citroën Relay/Jumper III
- Fiat Ducato
- Iveco Daily (03-10), Daily/EcoDaily (09-11)
- Peugeot Boxer III (06-12)
- 2.3D, 2.3 JTD F1AE0418A, F1AE0481B, F1AE0481C, F1AE0418D, F1AE0481F, F1AE0481FA, F1AE0481G, F1AE0481H, F1AE0481HA, F1AE0481N, F1AE0481UA, F1AE0481VA
- 3.0JTD F1CE0481A, F1CE0481B, F1CE0481D, F1CE0481F, F1CE0481H, F1CE3481M
- 3.0HDi F30DTE, F1CE0481D, F1CE3481DM, F1CE3481N

- 2 camshaft locking pins
- 1 crankshaft locking pin
- 2 camshaft locking pins
- 1 crankshaft locking pin

- to be used as OEM Fiat 99360187, 99360614, 99360615, 1860617000, 1860815000, 20000180200 / Citroën /Peugeot 0191-2A, 0191-2B, 0191-2J, 0191-2K



Item #
8422



Engine Timing Tool Set | for Rover, Peugeot, Ford, Volvo 2.0, 2.2l D

- allows inspection and adjustment of engine timing

suitable for the following models:

- Peugeot 807 (05-11), 407 (05-11), 607 (05-09), engine DW10UTED4 (RHK), DW10BTED4 (RHR)DW12BTED4 (4HS), (4HP), (4HT), (4HR)
- Citroën C4 (04-10), C5 II (04-10), engine DW10BTED4 (RHR)
- Land Rover Freelander (06-10), engine DW12BTED4, 224DT
- Volvo S40 (03-10), V50 (06-10), C70 (06-10), S80 (07-10), C30 906-10), V70 (07-10), engine D420T 2.0D
- Ford S-Max 2.2 (08-10), Galaxy 2.2 (08-10), Mondeo 2.2, 2.0 (07-10)
- engine codes: QXBA(2.2), QXWA(2.0), QXBB(2.0), Q4BA(2.2), QXWA(2.0), QXWB(2.0), AZBA(2.0), AZBC(2.0), AZWA(2.0)

- camshaft locking tool, to be used as OEM PSA 0188.M, Ford 303-735, 303-1277, Volvo 999-7122
- crankshaft locking tool, to be used as OEM PSA 0188.X, Ford 303-1059, 303-1270, Volvo 999-7121
- flywheel locking tool, to be used as OEM PSA 0188.F, Ford 303-393A (303-393-01, 303-1272, Volvo 999-7119/7120)



Item #
8529

Engine Timing Tool Set | for PSA 2.5, 2.8 l Diesel

suitable for the following models:

- Citroen, Peugeot, Fiat, Iveco Traffic (80-00), Master (80-07), Mascot (99-07)
- Fiat, PSA, Renault Daily (91-05), Turbo Daily (94-00), Relay / Jumper (01-02) Boxer (00-06), Arena (97-01), Movano (98-03)
- 2 locking pins
- flywheel locking pin
- holding tool for timing belt tensioner
- to be used as OEM Fiat 1 870 667 000, 1 870 765 001, 1 860 617 000 / Renault MOT861, MOT1054, MOT863 / Opel KM6031 / Ford 21-260, 303-732 / Peugeot 0132AB, 5711TD, 4527TS2, 0178D, 0194A, 119790 / Citroen 0132AB, 5711TD, 4527TS2, 0178D, 0194A, 119790 / Mazda 49 JE 02018, 0991246510 / Volvo 999-7169



Item #
8418

Camshaft Locking Tool | for 1.3l PSA Diesel

- for holding the camshaft when loosening and tightening the camshaft sprocket bolts
- required for works on camshaft drive
- suitable for Citroën, Peugeot, Fiat, Ford, Alfa Romeo 1.3 JTD
- recommended add-on for use with timing tool set BGS 8669
- to be used as Ford OEM 303-1475 / Fiat OEM 1871008600



Item #
9146

Engine Timing Tool Set | for Porsche Boxster, 911

- for checking the engine timing

suitable for the following Porsche models:

- Porsche Boxster (986 / 987) 2.5L (as of 1998), 2.7L (as of 2000), 3.2L (as of 2000)
- Porsche 911 (996 / 997) 3.6L (as of 2002), 3.4L (as of 2002)

- push pin / extension, to be used as OEM 9602
- aligning tool, to be used as OEM 9608
- TDC setting pin, to be used as OEM 9595
- camshaft locking tool, to be used as OEM 9612
- camshaft support, to be used as OEM 9611
- camshaft holding tool, to be used as OEM 9634



Item #
8836

Tool Tray 1/3: Engine Timing Tool Set | for Porsche Panamera, Cayenne V8 | 8 pcs.

- to check and adjust the camshaft timing
- is required when changing the cylinder head gasket, replacing the camshaft, etc.
- camshaft gauges suitable for Panamera / Cayenne as of 2008, to be used as OEM 9678/1
- camshaft gauges suitable for Cayenne, to be used as OEM 9678
- auxiliary chain tensioner suitable for Cayenne as of 2008, to be used as OEM 9683/1
- 27 mm socket, 10 mm (3/8") drive, 30 mm length, suitable for Cayenne, to be used as OEM 9714
- crankshaft aligning tool, to be used as OEM 9595/1



Item #	Description
8835	Tool Tray 1/3: Engine Timing Tool Set for Porsche Panamera, Cayenne V8 8 pcs.
8835-1	Tool Tray 1/3, empty for Item 8835



Engine Timing Tool Set | for Porsche 911 (996, 997)

- to check and adjust the camshaft timing
- is required when renewing the cylinder head gasket, changing the camshaft, etc.
- 1 camshaft holding tool, suitable for engine M96/03, to be used as OEM 9685
- 1 camshaft locking tool, suitable for engines M97/01 & M96/03, to be used as OEM 9686
- 2 locking pins, suitable for engines M97/01 & M96/03, to be used as OEM 9595 / 9595/1

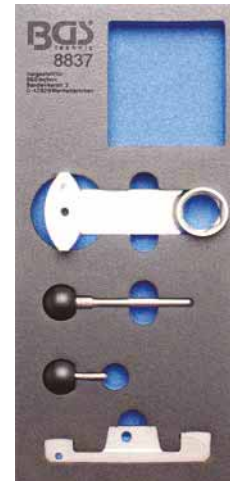

Engine Timing Tool Set | for Porsche Macan 3.0S / 3.6 Turbo

- is required when changing the timing chain, replacing the cylinder head gasket, etc.
- supplementary set to BGS 8835

suitable for the following models:

- Porsche Macan 3.0S / 3.6Turbo
- engine codes: MCT.M / MCT.L
- camshaft alignment tools, to be used as OEM 9861

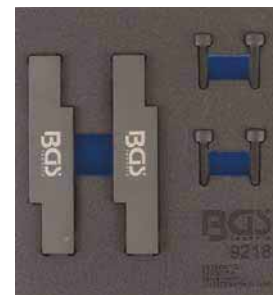

Engine Timing Tool Set | for Renault

- flywheel - crankshaft locking tools
- tools for adjusting the camshaft, pumpshaft
- fuel injection pump shaft
- pulling off the crankshaft pulley
- tensioning the timing belt
- includes adjusting gauge for camshaft, crankshaft, pumpshaft
- to be used as OEM tools MOT1348, MOT1312, MOT1135 -01, MOT1384, MOT1337, MOT1496, MOT910-1, MOT910, MOT861, MOT863, MOT1054, MOT1318, MOT1489, MOT1340, MOT1386, MOT1490, MOT1490-1, KM6031

suitable for the following Renault models:

- petrol 1.4, 1.6, 1.8, 2.0 l, each with 16 valves
 - 2.5 l 20V with double camshaft
 - petrol 1.2, 1.4, 1.6, 1.7, 1.8, 2.0, 2.2 l
 - diesel 1.9, 2.5, 2.8 l
- also to be used for Opel Arena/Movano and Volvo V/S 40

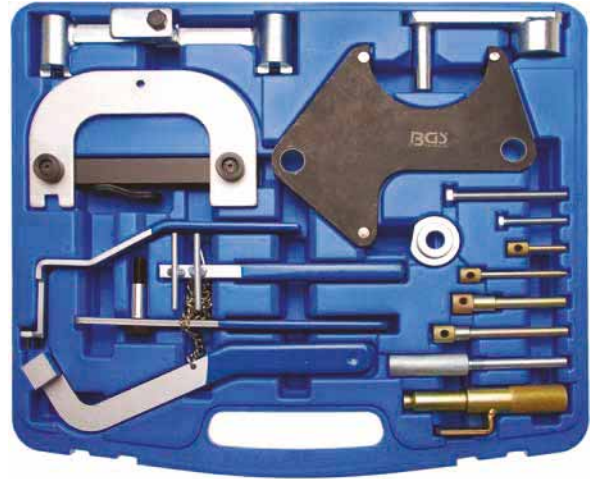

Item #	Description
8154	Engine Timing Tool Set for Renault
8154-1	Camshaft Tool for Renault for BGS 8154
8154-2	Crankshaft Locking Tool for Renault for BGS 8154
8154-4	Flywheel Fastening Clips for Renault for BGS 8154
8154-11	Camshaft Locking Tool for Renault 1.4 / 1.6 16v for BGS 8154
8154-15	Clamping Tool for Renault for BGS 8154
8154-LEER	Empty Case for BGS 8154

Engine Timing Tool Set | for Renault, Opel, Nissan | 12 pcs.

- for positioning and locking the crankshaft and camshaft when repairing the timing belt and engine

suitable for the following models:

- Renault Avantime (2005 - 2007) - Clio (2001 - 2008) - Espace (2000 - 2008) - Kangoo (2000 - 2008) - Laguna (1999 - 2001) - Laguna II (2004 - 2007) - Master (2000 - 2006) - Megane (1999 - 2008) - Modus (2004 - 2008) - Scenic (1999 - 2008) - Traffic (2001 - 2008) - Twingo (2007 - 2008)
- Nissan Almera N16 (2002 - 2006) - Interstar (2002 - 2006) - Kubistar (2003 - 2008) - Micra K12 (2003 - 2008) - Note (2006 - 2008) - Primastar (2002 - 2007) - Primera P12 (2003 - 2007) - Qashqai (2008 - 2009)
- Opel Movano (2000 - 2008) - Vivaro (2001 - 2008)
- engine codes: 1.5 (K9K), 1.9 (F9Q), 2.2 (G9T), 2.5 (G9U)
- inlet camshaft locking tool to be used as OEM KM6205 (MOT1534)
- exhaust camshaft locking tool to be used as OEM KM6204 (MOT1537)
- injection pump locking tool to be used as OEM MOT1538
- 5-piece clamping tool set to be used as OEM MOT1543
- locking pin to be used as OEM MOT1430
- crankshaft locking pin to be used as OEM MOT1536



Item #
62505

Engine Timing Tool Set | for Nissan, Renault, Opel

- for adjusting the engine timing

suitable for the following models:

- Nissan Primaster (2008 - 2009), Qashqai (2008 - 2009), X-Trail (2007 - 2008) with engine codes M9R 780, 830, 832, 833
- Renault Koleos (2008 - 2009), Laguna (2005 - 2008), Megane (2007 - 2008), Scenic (2008 - 2009), Trafic (2007 - 2008), Vel Satis (2008 - 2009) with engine codes M9R 700, 721, 724, 740, 742, 446, 760, 761, 780, 802, 803, 805, 830, 832, 833
- Vauxhall, Opel Vivaro (2007 - 2008) with engine codes M9R 780, 782, 784
- crankshaft pulley holding tool, to be used as OEM Renault/Nissan EN-48334, Opel KM-956-1
- camshaft adjusting tool, to be used as OEM Renault MOT1769, Opel & Nissan EN-48332
- camshaft gear alignment tool, to be used as OEM Renault MOT1773, Opel & Nissan EN-48331
- crankshaft adjusting tool, to be used as OEM Renault MOT1766, Opel & Nissan EN-48330
- chain tensioner locking tool 2.96 mm
- belt tensioner locking tool

Item #
8421



Camshaft Locking Tool | for Renault 1.8 / 2.0 16V

- for locking the camshaft gears
- to be used as MOT 1509-01, 1509
- suitable for Renault Laguna II (2001 - 2009), Megane II (2002 - 2009), Scenic (2002 - 2009)
- with engine codes 700, 701, 712, 713, 714, 715, 720, 721, 722, 722, 730, 732, 736, 738, 740, 741, 744, 746, 747, 760, 761, 762, 763, 764, 765, 766, 767, 770, 771, 773, 774, 774, 775, 776, 784, 786, 787, 790, 792, 794, 797, 830, F4P, F4R

Item #
8577



Engine Timing Tool Set | for Renault, Opel, Volvo, Mitsubishi, Chrysler

- for adjusting the engine timing on Renault petrol and diesel engines

suitable for the following models:

- Renault:
 - Clio (1990-2013), Espace / Grand Espace (1996-2002), Extra / Rapid / Express (1991-2002), Kangoo (1998-2009), Laguna (1994-2001), Megane (1995-2003), Scenic (1996-2003), Modus / Grand Modus II (2004-2013), Safrane (1992-2001), Trafic (1997-2000), Master II (2000-2003), Twingo (2000-2013), Wind (2011-2013)
- Opel:
 - Arena (1997-2001), Movano-A (1999-2006), Vivaro (2001-2007)
- Volvo:
 - S40 (1996-2004), V40 (1996-2004)
- Mitsubishi:
 - Carisma (2001-2005), Space Star (2000-2006)
- Chrysler:
 - Cherokee (1984-1995), Wrangler (1988-1995)

engine codes:

- E7F 1.2: 700, 704, 706, 708, 750
- D4F 1.2 16v: 702 / 704 / 706 / 708 / 712 / 714 / 716 / 722 / 728 / 730 / 740 / 742 / 764 / 772 / 780 / 782 / 784 / 786
- E7J 1.4: 601 / 624 / 626 / 634 / 635 / 710 / 711 / 716 / 718 / 719 / 754 / 756 / 757 / 764 / 780
- F3P 1.8: 674 / 676 / 678 / 710 / 712 / 714 / 720 / 724 / 755 / 758 / B670 / Q7 / R7 / S724
- F7P 1.8 16v: 720 / 722
- F8Q 1.9D/Di/Turbo: 600 / 606 / 620 / 622 / 624 / 630 / 632 / 644 / 646 / 648 / 662 / 672 / 676 / 678 / 680 / 682 / 684 / 692 / 696 / 714 / 722 / 724 / 730 / 732 / 776 / 784 / 786 / 788 / 790 / B640
- F9Q 1.9D dTi: F9Q1 / F9Q2 / 710 / 716 / 717 / 720 / 722 / 730 / 731 / 734 / 736 / 744 / 760 / 762 / 770 / 774 / 780 / 782 / 790 D4192T / D4191T2 D4192T3 / D4192T4
- F3R 2.0: 611 / 722 / 723 / 742 / 750 / 751 / 752 / 768 / 769 / 791 / 796 / 797 / 798
- J7R 2.0: 732 / 733 / 734 / 735
- F7R 2.0 16V: 700 / 714 / D710
- J7T 2.2 16V: 760 / 761
- G8T 2.2D/Turbo: 706 / 714 / 716 / 740 / 752 / 760 / 790 / 792 / 794

- camshaft locking tool, adjustable for DOHC engines
- high pressure diesel pump locking pin, to be used as OEM Mot.910
- tensioner spanner, to be used as OEM Mot1135-01
- crankshaft locking pin, to be used as OEM Mot.1318
- crankshaft locking pin, to be used as OEM Mot.1054
- crankshaft locking pin, to be used as OEM Mot.910



Item #

9367

Engine Timing Tool Set | for Renault, Volvo, Ford 16V, 20V Petrol Engines

- contains important tools for adjusting the engine timing
- 1.6 - 1.8 - 1.9 - 2.0 - 2.3 - 2.4 - 2.5 l DOHC engines

suitable for the following models:

- Renault Laguna (built 1996 - 1999), Safrane (built 1996 - 2001) with the engine codes: N7Q 704, 710, 711 N7U 700, 701
- Ford Kuga (02/2008-), Focus ST RS (07/2004-), S-Max (03/2006-), Galaxy (03/2006-), Mondeo (02/2007-) with the engine codes: JZDA, HYDB, HYDC, HUWA
- Volvo 850 (built 1992 - 1997), C70 (built 1998 - 2002), S40 (built 1996 - 2004), V40 (built 1996 - 2004), S60 (built 2001 - 2005), S70 (built 1997 - 2000), S80 (built 1999 - 2005) with the engine codes: B4164 S/S2, B4184 S/S2/S3/S9/S10, B4194 T/T2, B4204 S/S2/T/T2/T3/T5, B5202 FS, B5204 FT/T2/T3/T4/T5, B5234 T3/T4/T5/T6/T7/T8/T9, B5244 S/S2/SG/SG2/T3/T4/T5/T7, B5252 FS, B5254 T/T2/T4
- camshaft locking tool, to be used as OEM MOTMOT1337, 999-5452, 303-1178
- tensioner pulley wrench, to be used as OEM MOT1348
- flywheel locking tool, to be used as OEM MOT1340, 999-5451, 303-1182



Item #
8417

Engine Timing Tool Set | for Renault 1.5, 1.9 DCI

- for changing the timing belt
- suitable for Renault Laguna, Kangoo, Clio with 1.5, 1.9 DCi-engines
- crankshaft locking pin, to be used as OEM MOT 1489
- camshaft / crankshaft timing pin, to be used as OEM 0194B, 999-7122, 21-263, MOT 1430, 0187B, 0189B, 607589011500
- TDC timing pin, to be used as KM603 OEM, MOT 1054 MOT 861 MOT 863



Item #
8145



Locking Tool for Injection Pump Sprocket | for Renault

- for locking the injection pump sprocket for timing belt replacement and other works when dismantling of the timing belt is required
- suitable for the following models: Renault Clio, Megane, Laguna, Kangoo with 1.9 TDi, engine code: F9Q
- to be used as OEM 1200-01



Item #
8407

Locking Pin Set | for automatic Belt Tensioner

- suitable for locking belt tensioners
- locking pin Ø 1.9 - 1.7 - 1.5 - 1.4 - 1.25 - 0.8 mm
- length of pins: 47 mm
- made of spring steel
- on aluminum hook



Item #
8438



Tool Tray 3/3: Engine Timing Tool Set | for Renault, Nissan, Opel, Volvo

- for checking and adjusting the engine timing

suitable for the following models:

- Renault: Clio 1-2-3-4, Clio Sport 1-2-3, Mégane 1-2-3, Master 1-2, Mégane Scénic 1-2-3, Vel Satis 1-2, Avantime, Kangoo 1-2-3, Laguna 1-2-3, Espace 1-2-3, Trafic 1-2, Wind, Modus, Twingo, Koleos
- Dacia: Logan, Duster, Sandero, Dokker
- Nissan: Note, Qashqai, Micra, Interstar, Primastar, Kubistar, Almera, Primera
- Opel: Vivaro, Movano
- Volvo: S 40, V 40

suitable for gasoline and diesel engines:

- 1.2 - 1.2 16V - 1.4 - 1.4 16V - 1.5DCI - 1.6 - 1.6 16V, 1.6D - 1.7 - 1.8 - 1.8 16V - 1.9TD - 1.9 - 1.9DCI, 1.9DTI - 1.9CDTI - 2.0 - 2.0 16V - 2.1TD - 2.2, 2.2DCI - 2.2DTI - 2.2TD - 2.5DCI - 2.5CDTI - 2.5TD - 2.8D
- camshaft locking tools, to be used as OEM MOT 1496, MOT 1750, MOT 1337, MOT 1534, KM-6205, MOT 1537, KM-6204
- camshaft gear adjusting tool, to be used as OEM MOT 1490-01
- crankshaft locking pins, to be used as OEM MOT 1054, KM-6031, KV113 B0280, MOT 1489, KV113 B0130, MOT 1340, MOT 910, MOT 1318, MOT 1489, MOT 1337, MOT 1536, KM-6203, MOT 1054
- tensioning tools, to be used as OEM MOT 1348, MOT 1312, MOT 1384, MOT 1135-01, MOT 1543, KM-6234, KV113 B0360, MOT 1386
- screw M6 x 45 mm
- screw M8 x 80 mm
- high pressure injection pump locking pins, to be used as OEM MOT 1538, MOT 1200-01



Item #
4134



Tool Tray 3/3: Engine Timing Tool Set | for Fiat, Ford, Citroën, Peugeot

- for adjusting the engine timing when renewing the tooth belt, replacing the cylinder head gasket, etc.

suitable for the following models:

- Fiat Ulysse, Scudo, Ducato
- Lancia Zeta, Phedra
- Ford Fiesta, Fusion, Focus, Focus C-Max
- Citroen C15, C1, C2, C3 Pluriel, C4, C4 Picasso, C5, C6, C8, DS3, DS4, DS5, Xantia, Xsara, Xsara Picasso, Evasion, Berlingo, Jumpy, Jumper, Saxo, ZX, XM, Evasion, AX
- Peugeot 107, 1007, 206 cc, 207, 208, 306, 307 cc, 308, 406, 407, 508, 607, 806, 807, Partner, Expert, Boxer, 206, 106, 605, 205, 405
- Lancia / Fiat 2.0 & 2.2 JTD

suitable for engines:

- DW12TED4 (4HW), DW10ATED (RHT/RHV/RHW/RHX/RHZ)
- Ford 1.4 / 1.6 Duratorq TDCI
Motorcodes: F6JA, F6JB, F6JC, G8DA, G8DB, HHDA, HHDB, HHJA, HHJB
- Citroen / Peugeot 1.0 / 1.1 / 1.4 / 1.6 / 1.6 16V, 1.4 / 1.6HDI / 1.8 / 1.8 16V / 2.0 / 2.0 Turbo, 1.9D / 2.0HDI / 2.2HDI / 1.8 16V / 2.0 16V
- flywheel puller, to be used as OEM 0188-P2, 0188-P, 174, 7015-T
- tensioner pulley locking levers, to be used as OEM 0188-J1, 0188-J2
- tensioner pulley locking pins, to be used as OEM 0188-Q2, 0188-AH, 0189-S2
- timing belt retaining clip, to be used as OEM 0132-AK, 0188-AK, 0189-K, 0153-AK, 4533-TAD, MOT 1436
- flywheel locking pins, to be used as OEM 0153-N, 0188-Y, 7014-TJ, 7099-TM, 9797-34, 0188-D, 7017-TM, 0132-P, 4507-TL, 7017-TR, 0153-M, 0178-C, 0178-D, 7014-TM, 9767-94, 0189-B, 21-163, 0132-AJ1, 0153-G, 0188-M, 0189-J, 4533-TAC1, 5711-TA, 0189-L, 0189-C, 0189-R, 0153-U, 7019-T, 0132-Q, 0132-QZ, 4507-TA, 9767-27, 0132-X, 0188-Q1, 4507-TJ, 9767-89
- tensioner pulley locking pins, to be used as OEM 4200-TH, 0117-AR
- tensioning tool, to be used as OEM 0178-E
- flywheel locking tool, to be used as OEM 0153-A, 6012-T, 9765-54, 0134-AF, 0134-Q, 0188-F, 9004-T
- pulley locking lever, to be used as OEM 0606-A1-A2
- tensioner pulley adjusting tool, to be used as OEM 0189-S1



Engine Timing

Item #		
4135		

Tool Tray 3/3: Engine Timing Tool Set | for Ford, VAG, Mazda, Volvo

- for checking and adjusting the engine timing

suitable for the following models:

- Audi 80, A1, A2, A3, S3, A4, A5, A6, TT, Q5
- Seat Arosa, Ibiza, Cordoba, Leon, Toledo, Alhambra, Altea, Inca (99-04)
- Skoda Fabia, Octavia, Superb
- VW Lupo, Polo, Fox, Golf, Bora, Jetta, Golf Plus, Passat, Beetle, Touran, Sharan, Caddy, Caddy Maxi, Transporter, Golf VI Cabrio, Tiguan
- Ford Galaxy

petrol engines:

- 1.2 TSI / 1.4 / 1.4 TSI / 1.6 16V / 1.2 9V-12V 3-Zyl., 1.4 / 1.6 FSi (camshaft timing chain), 1.8 / 1.8 16V / 1.8T / 2.0 16V / 2.0 FSi / TFSI (timing belt)

diesel engines:

- 1.2 / 1.4 / 1.9 / 2.0 TDI PD, 1.9 TDI 75-90-110, 1.9 SDI 75-90-110, 1.9 TDI 105-130-150, 2.0 TDI DPF 140-170, 2.5 TDI V6
- camshaft locking & adjusting tools, to be used as OEM 3458, T30094, T10016, T10074, T10074, MP1-1312, T10098, T20038, 3418, T10123, T10121, T10120, T10252, T10171, 2065-A, 21-105
- crankshaft locking & adjusting tools, to be used as OEM 3242, T40069, T30052, T40026, T10414, T10100, T10340, T10341
- injection pump locking & adjusting tools, to be used as OEM 3359, T20102, 2064, U20003
- chain tensioner, tooth belt tensioner & drive belt tensioner tools, to be used as OEM 23-058, 310-084, T10008, 2065A, T10008, U40021, T10092, T40011, T10060, T10060A, T00115, T10264, T40098, 303-1054, T10115, T10092, T40011, T00115, T10264, T40098
- chain tensioner / crankshaft sprocket holder, to be used as OEM 3366, T20018, T20044
- crankshaft sprocket aligning tool, to be used as OEM 23-059, 310-085, T10050
- lever / wrench for tensioning the tooth belt, to be used as OEM 3387, U30009A, 2587, MATRA V.159, 3387, T10020
- locking bracket, to be used as OEM MP1-1312, T10098, T20038
- support guides, to be used as OEM OEM 3369, T30092, 3411
- TDC indicator, to be used as OEM T10170
- dial test indicator, to be used as OEM VAS6079



Engine Timing

Item #		
4136		

Tool Tray 3/3: Engine Timing Tool Set | for Fiat, Alfa, Lancia, Opel, Suzuki, Ford

- for checking and adjusting the engine timing

suitable for the following models:

- Alfa Romeo 145 / 146 / 147 / 155 / 156 / 159 / 166 /
- Spider / GTV / TS / GT / Crosswagon Q4
- Fiat Punto / Grande Punto / Brava / Bravo / Marea / Weekend / Stilo / Doblo / Cargo /
- Idea / Panda / Multipla / Palio / Stilo / 500
- Lancia Lybra / Ypsilon / Thesis / Musa
- Opel Corsa / Agila / Meriva / Combo / Vectra / Zara / Astra / Insignia / Signum 1.9 CDTI
- Suzuki Ignis / Swift / Wagon R+
- Ford Ka

engines:

- 1.2 8V / 1.2 16V / 1.4 16V / 1.6 16V / 1.6 MultiJet / 1.9 JTD / 1.9 JTD 16V / 1.9 MultiJet / 1.9 CDTI / 2.0 MultiJet / 2.4 JTD 20V / 2.4 JTD / 1.3 JTD MultiJet / 1.3 CDTI / 1.3 TDCI / 1.9 CDTI
- camshaft locking & adjusting tools, to be used as OEM 1860874000, 1860874000, 1860985000, 1825041000, 1825041000, 1825042000, 1825042000, 1860847000, 1860847000, 2000004300, 1871000900, 2000004400, 2190754400, 1870896900
- crankshaft & flywheel locking tools, to be used as OEM 1860161000, 1860905000, EN-46788, 1860771000, 1860898000, 1860863000, 1870900300, 1860703000, 2190754500, 2000004200, 2190754200, 1860905000, 2000004500, 2190754500
- injection pump adjusting tools, to be used as OEM 1860965000
- tensioning tools, to be used as OEM 1860876000, 1860987000, 1860845000, 1860876000, 1870900400
- TDC indicators, to be used as OEM 1860992000, 1895443000



Engine Timing

Item #		
4137		

Tool Tray 3/3: Engine Timing Tool Set | for Fiat, Alfa, Lancia, Opel, Suzuki, Ford

- for checking and adjusting the engine timing

suitable for the following models:

- Opel Corsa B/C / Combo / Tigra / Agila / Tigra B / Meriva / Astra F/G/H / Astravan / Speedster VX220 / Zafira A/B / Vectra B/C / Signum / Omega B / Sintra / Frontera A/B / Astravan / Kadett / Ascona / Omega / Monterey / Antara / Croma / Speedster VX220
- Chevrolet & Daewoo Epica / Captiva / Nubira / Lacetti / Evanda
- Saab 9-3 / 9-5 (98-04)
- Alfa 145 / 146 / 147 / 156 / 159 / 166
- GT / Crosswagon Q4
- Fiat Punto / Grande Punto / Bravo / Brava / Marea Weekend / Stilo / Doblò/Cargo / Multipla Idea / Panda
- Lancia Ypsilon / Musa / Lybra / Thesis
- Suzuki Ignis / Swift / Wagon R+
- Ford Ka

engines:

- 1.0 12V / 1.0 16V / 1.2 16V / 1.4 / 1.6 / 1.2-1.4 16V (chain) / 2.0 / 2.0 Turbo / 2.2 DI / 2.0-2.2 16V / 1.6 16V / 1.8 16V / 2.0 16V / 2.2 16V / 1.3 JTD MultiJet / 1.3 CDTI / 1.3 TDCI / 1.6 MultiJet / 1.9 JTD / 1.9 MultiJet / 2.4 JTD / 1.9 CDTI / 2.0 MultiJet / 1.5 D / 1.5 TD / 1.7 D / 1.7 TD / 1.6-1.7 D / 3.0 TD / 3.1TD / 2.0-2.2-2.4 TD / 2.0-2.2 DI / 2.0 TDCI / 2.0 D VCDI / 2.2 16V (DOHC)
- adjusting wrench, to be used as OEM KM-933
- injection pump locking pin, to be used as OEM KM-927
- flywheel & crankshaft locking tools, to be used as OEM KM-929 / KM-952 / EN-46785 / KM-951 / 1860905000 / 1860905010 / EN-46788 / KM-911 / EN-46785 / 1860703000 / EN-48246 / 1870900300 / 303-1468
- tensioner tools, to be used as OEM KM-955 / KM-6130 / KM-6349 / KM-6349 / 1870900400 / 1871000200



Item #		
4138		

Tool Tray 3/3: Engine Timing Tool Set | for Ford, VW, Seat, Mazda, Volvo

- for checking and adjusting the engine timing

suitable for the following models:

- Ford Fiesta, Fusion, Courier, Escort, Focus, Focus C Max, Puma, Mondeo, Sierra, Cougar, Galaxy, C-Max, Orion, Tourneo Connect, Transit, Transit Connect
- VW Sharan
- Seat Alhambra
- Mazda 121
- Volvo S40, V50

gasoline engines:

- 1.2 / 1.25 / 1.4 / 1.6 / 1.6 / 1.7 / 1.8 / 2.0 16V / 1.6 TI-VCT / 1.6 SCTI

diesel engines:

- 1.6 Duratorq TDCI / 1.8D / 1.8TD / 1.8 DI (98-04) / 1.8 TDCI (01-04) / 1.6D / 1.9TDI / 2.5D TCI / 1.9TDI / 2.5D/TCI / 1.4TDCI / 1.6TDCI / 1.8D / 1.8TCI / 1.8TDDI / 1.8TDCI / 1.8D Turbo / 1.9TDI PD / 2.0TDCI / 2.2TDCI / 2.5D / 2.5D Turbo / 2.0 / 2.2 / 2.4 Duratorq TDCI 16V / 1.4TDCI / 1.6D 8V / 1.6D 16V

scope of delivery:

- camshaft adjusting tools, to be used as OEM 21-105, 303-1061, 21-162B, 303-367, 303-376, 323-029
- injection pump adjusting tools, to be used as OEM 2064, 23-047, 310-055, U20003, 21-260, 303-732, 23-020, 21-238, 303-679A, 303-1151
- flywheel / crankshaft locking tool, to be used as OEM 303-1060, 0132-AB, 0178-D, 21-151, 0194-B, 21-263, 303-735, 49JE02021, 21-234, 21-251, 0194-C, 21-262, 303-734, 21-163, 303-620, 21-210, 21-123, 21-234, 21-251, 303-675, 303-698
- camshaft sprocket puller, to be used as OEM 21-229, 303-651
- feeler gauge



Item #		
4139		

Engine Timing Tool Set | for Hyundai, Mitsubishi

- includes important tools for checking engine timing and changing timing tooth belt

suitable for the following models:

- Hyundai 1.6 / 1.8 / 2.0 / 2.4 Twin Cams and Mitsubishi 1.8 to 3.5 16V and V6
- Mitsubishi Colt ('89-'95), Lancer ('89-'95), Carisma ('96-'05), Galant 93-03, Sigma ('91-'96), Eclipse-91-95, 300DTG ('93-'00), Space Star ('99-'06) with engines 1.8 16V GDI (4G63, 4G94); 2.0 16V GDI (4G63, 4G94, 6A12) 2.4 GDI (4G64, 4G69); 3.5 GDI V6 (6G74) 2.5 V6 (6G73, 6a13); 3.0 V6 (6G72)
- Hyundai Lantra ('91-'96), Sonata ('93-'01), Trajet ('00-'05), Santa Fe 6.1
- with engines G4-N, G4-CP, 4JP, G4-P-, G4-R-, G4-JS



Item #	
8530	

Engine Timing Tool Set | for Toyota, Mitsubishi

- suitable for Toyota, Mitsubishi and identical models
- important kit when working on the engine, e.g. timing belt, basic motor settings, camshafts, etc.
- handle puller, to be used as OEM 09330-0021
- gear tool, to be used as OEM 09278-54012
- drive tool for crankshaft pulley, to be used as OEM 09223-15030
- holding tool for pulley / crankshaft, to be used as OEM 09213-54015 screws for holding tool 09213-54015
- holding tool for pulley / crankshaft, to be used as OEM 09213-14010 screws for holding tool 09213-14010
- puller C set SST, to be used as OEM 09951-50013
- cross-piece 150 mm 7, to be used as OEM 09951-05010
- slider, 2 pcs. 29, to be used as OEM 09952-05010
- bolt 100 27, to be used as OEM 09953-05010
- bolt 150 28, to be used as OEM 09953-05020
- 8 pulling arms, M5 to M8 OEM 09954-05011 to 05080
- adaptor no. 1, M10 x 1.25; 2 pcs., to be used as OEM 09555-05010
- adaptor no. 1, M10 x 1.5; 2 pcs., to be used as OEM 09555-05020
- adaptor no. 1, M12 x 1.25; 2 pcs., to be used as OEM 09555-05030
- adaptor no. 1, M12 x 1.5; 2 pcs., to be used as OEM 09555-05040
- supplement connection piece, to be used as OEM 09957-04010
- holding tool for pulley / crankshaft, to be used as OEM XB990757
- belt tensioner tool, to be used as OEM XD998738
- holding tool for pulley / crankshaft, to be used as OEM XD998767

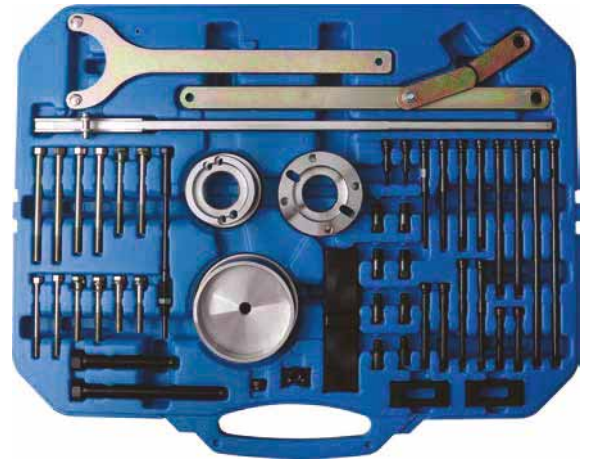

Engine Timing

Item #
68310

Diesel Fuel Pump Timing Set | 10 pcs.

- for an accurate adjustment of several different fuel injection pumps e. g. Bosch VE, Kikki, Lucas, CAV-Roto, Nippon Denso
- measuring adapter for piston height adaptor M14, to be used as OEM T10170
- measuring adapter, long M8
- measuring adapter, short M8
- measuring adapter, short M10
- probe, to be used as OEM 999-5382
- extension, length 99mm
- extension, length 40.8mm
- mounting bracket (CAV)
- thread adaptor M8
- thread adaptor M10
- dial test indicator, to be used as OEM KM-571-A , 3313, VAS6079





Item #	Description
8157	Diesel Fuel Pump Timing Set 10 pcs.
8157-1	Gauge for BGS 8157 Ø 41 mm

Camshaft Sprocket Locking Tool Set | universal

- for locking camshaft sprockets when renewing the tooth belt
- suitable for engines with 1, 2 or 4 camshafts (V-engines), also suitable for locking between camshaft sprocket and diesel injection pump sprockets on certain diesel engines
- universal application on vehicles of the following manufacturers:
 - Audi, Alfa Romeo, Chrysler, Citroen, Ford, Honda,
 - Hyundai, Isuzu, Land Rover, Lexus, Mazda,
 - Mitsubishi, Peugeot, Renault, MG, Seat, Skoda,
 - Subaru, Toyota, Opel, Volkswagen, Volvo
- twin camshaft locking tool with short and long connecting arm
- single camshaft locking tool with short and long locking screw



Item #		
9307		

Camshaft Locking Tool

- needed for tooth belt replacement and other engine timing jobs
- suitable for most Diesel and gasoline DOHC engines
- fixation by locking the camshafts against each other
- pins made of hardened steel for long tool life
- versatile applications because of 2 different arm lengths
- special knob on center arm can be turned into a place-saving position



Item #
8243

Twin Cam Lock | for double cam motors

- can be used for toothed belt distances 13 - 180 mm - for Diesel and Gasoline engines
- locks the camshaft on the side of the fuel injection pump wheel, so that the toothed belt wheels can be correctly positioned towards the crankshaft



Item #
1799



Pulley Holder for the High-Pressure Pump | for Opel, Renault, Nissan

- suitable for diesel engines with F9Q engine code
- in Opel, Renault, Nissan cars
- no need to disassemble the tooth belt
- pump wheel is locked securely
- pump does not need to be re-adjusted



Item #
8278

Setting and Timing Tool for Diesel Pumps | for Renault, Mitsubishi, Opel

- for F8Q and F9Q diesel engines with adjustable pump wheel
- used in Renault Megan / Scenic / Kangoo, Mitsubishi Carisma, Opel / Vauxhall Arena, Volvo S40 / V40 etc.
- special socket with 27 mm hexagon and 1/2" drive
- setting tool with 3 x 4 mm pins to adjust the pump
- adaptor for Bosch pumps M10 to M8



Item #
8281

TDC Finder

- for easy and accurate determination of the ignition TDC (top dead centre)
- especially suitable for vehicles which have no TDC markings
- measurement unit with magnetic holder
- connecting tube with spark plug or glow plug adaptor in 8 -10 -12 -14 -18 mm + universal cone adaptor
- 60 and 160 mm aluminium adaptor tube for deep seated spark plugs



Item #	Description
8304	TDC Finder
8304-LEER	Empty Case for BGS 8304

Engine Timing Tool Set | for VAG

suitable for the following engines:

- 1.9/2.0 | TDI pump/nozzle
- 1.9 | TDI
- 2.5 | V6-TDI
- 3.3 | V8-TDI
- 1.2 | 3-cylinder and 1.4/1.6 | gasoline engines

important adjustment tools such as:

- setting gauge for the camshaft (e. g. VW 1.9 | TDI)
- locking tool for the timing belt (e. g. VW / Skoda 1.9 | / 2.0 | TDI pump/ nozzle)
- camshaft locking tool (e.g. VW / Audi 2.5 | V6 TDI)
- adjustable tensioner wrench (universal for VW / Audi)
- injection pump locking pin (e.g. VW / Audi / Seat / Skoda)
- mounting plate for timing belt tensioner (VW / Skoda 4 cyl. TDI pump/ nozzle)
- 22 mm open socket for diesel injectors
- camshaft setting tools, to be used as OEM T10123, T10120, 3458, 3418, 2065A, 3366, T10098 / 3418
- crankshaft setting tools, to be used as OEM T10121, 3242, T10050, T10100
- tensioner pulley locking pins, to be used as OEM T10060A, T10020, T10008, T40011
- injection pump locking tools, to be used as OEM 3359, 2064



Engine Timing

Item #	Description
8155	Engine Timing Tool Set for VAG
8155-1	Engine Timing Tool Set for VW 1.2 2 pcs.
8155-01	Camshaft Alignment Tool for VAG for BGS 8155
8155-2	Special Tool for checking the Engine timing for VAG 1.2
8155-5	Crankshaft Locking Tool for BGS 8155
8155-6	Crankshaft Locking Tool for VAG 6 and 8 Cylinder Engines for BGS 8155
8155-8	Camshaft Locking Tool for BGS 8155
8155-9	Tensioner Wrench for VAG
8155-12	Injector Spanner for BGS 8155
8155-15	Locking Screw for BGS 8155
8155-16	Stud with Nut for BGS 8155
8155-17	Fixing Pin for Tensioner Pulley
8155-18	Camshaft Alignment for VAG for BGS 8155
8155-19	Camshaft Locking Tool for BGS 8155
8155-20	Injection Pump Locking Tool for BGS 8155
8155-23	Locking Pin for BGS 8155 Ø 2.5 mm
8155-25	Locking Tool for Engine Setting for BGS 8155
8155-26	3-Side Wrench for Engine Timing for VAG
8155-LEER	Empty Case for BGS 8155

Engine Timing Tool Set | for VAG 1.6, 2.0 CR TDI

suitable for the following models:

- Audi A1, A3 (8P), A4 (B8), A5A6 (C6, C7), TT (8J), Q3, Q5
- Skoda Fabia II, Roomster, Praktik, Octavia II, Suber II, Yeti
- Seat Ibiza (6J), Leon III, Exeo, Altea, Alhambra II
- VW Golf V, VI and Plus, Eos, Polo V Jetta V and VI, Scirocco III, Beetle II, Caddy II, Passat B6, B7 and CC, Touran, Sharan II, T5, Amarok
- engine codes: CAYB, CAYC, CBAB, CBBB, CBAA, CFFB, CAGA, CAHA, CAGB, CAHB, CAGC, FCA, CAAA, CAAB, CAAC, CCHA, CAVA, CBAB, CBDA, CBDD, CBAC, CBDA, CBDC, etc.
- also suitable for earlier pump-nozzle engines
- includes important tools for checking and adjusting engine timing after e. g. timing belt replacement
- injection pump locking pin to be used as OEM T20102, U40074, 3359
- crankshaft locking tool to be used as OEM T10050, T10100
- ball end hex key 6 mm to be used as OEM T10264
- 2.5mm tensioner pulley locking pin to be used as OEM T10265
- 3.9mm tensioner pulley locking pin to be used as OEM T40098
- sprocket holding tool to be used as OEM T10051
- camshaft sprocket hub puller to be used as OEM T10052
- oil pump balancer shaft alignment tool to be used as OEM T10255



Item #	Description
66200	Engine Timing Tool Set for VAG 1.6, 2.0 CR TDI
66200-1	Puller for Engine Setting for VAG

Engine Timing Tool Set | for VAG 2.7, 3.0 TDI

- suitable for Audi A4, A5, A6, AB, Q5, Q7 and VW Touareg, Phaeton with engine codes ASB, BKN, BKS, BMK, BMZ, BNG, BPP, BSG, BUG, BUN, CAMA, CAMB, CANA, CANB, CANC, CAND, CAPA, CARA, CARB, CASA, CASB, CASC, CATA, CCMA, CCWA, CCWB, CDYA, CDYB, CDYC, CEXA, CGKA, CGKB
- for locking the camshaft, crankshaft and fixing the chain tensioner
- required for timing chain replacement or engine repair
- camshaft locking pin to be used as OEM T40062
- camshaft tool to be used as OEM T40061
- rotating adaptor for crankshaft to be used as OEM T40049
- locking pin for injection pump to be used as OEM 3359
- rotating adaptor for crankshaft to be used as OEM T40058
- 2 camshaft locking tools, to be used as OEM T40060
- crankshaft locking pin to be used as OEM 3242
- 2 locking pins for chain tensioner

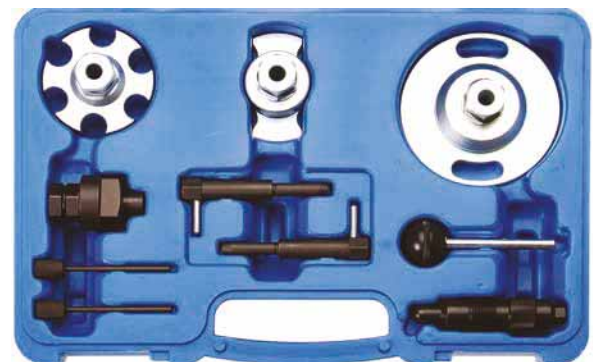

Item #
66205

Engine Timing Tool Set | for VAG

- suitable for 1.8 l turbo and 1.6 l FSI engines

suitable for the following models:

- Audi:
 - A3 1.8 Turbo (AGN AGU AJQ APG APP AQA ARX ARY ARZ AUM AUQ) 1996-2003
 - A3 1.6 FSI (BAG) 2003-2006
 - S3 1.8 Turbo (AMK APY BAM) 1996
 - A4 1.8 Turbo (ADR AEB AJL AJP ANB APU AVJ AWT) 1994-2006
 - A6 1.8 Turbo (ADR AEB AJL AJP ANB APU AVJ AWT) 1994-2006
 - Cabriolet 1.8 (ADR) 1997-2000
 - TT 1.8 Turbo (AJQ APP APX AUM AUQ BAM) 1998-2006
 - Volkswagen:
 - Beetle 1.8 Turbo (AVC) 1999-2006
 - Touran 1.6 FSI (BAG BLP) 2003-2007
 - Golf 1.8 Turbo (AGN AGU AQA ARZ AUM AUQ) 1997-2005
 - Bora 1.8 Turbo (AGN AGU AQA ARZ AUM AUQ) 1997-2005
 - Passat 1.8 Turbo (ADR AEB ANB APT APU ARG AWT) 1996-2005
 - Seat:
 - Sharan 1.8 Turbo (AJH AWC) 1997-2007
 - Ibiza 1.8 Turbo (AQX AYP) 1999-2002
 - Cordoba 1.8 Turbo (AQX AYP) 1999-2002
 - Leon 1.8 Turbo (AJQ AQN APG APP APT ARYAUQ) 1999-2005
 - Toledo Turbo (AQN APG APT ARY AUQ) 1999-2005
 - Alhambra 1.8 Turbo (AJW AWC) 1997-2007
 - Skoda:
 - Octavia 1.8 FSI Turbo (AGN AGU ARX ARZ AUM) 1996-2005
 - Octavia 1.8 Turbo 20V RS (AUQ) 2000-2006
 - Octavia 1.6 FSI (BLF) 2004-2007
- crankshaft counterholder to be used as OEM 3036
 - camshaft locking tool to be used as OEM T10171
 - counterholder for timing chain sprocket camshaft, vibration damper, to be used as OEM T10172
 - adaptors for counterholder, to be used as OEM T10172
 - holder for chain adjuster for assembly and disassembly of the chain adjuster, to be used as OEM T20018 / 3366
 - fixing pin for tensioner pulley, to be used as OEM T40011

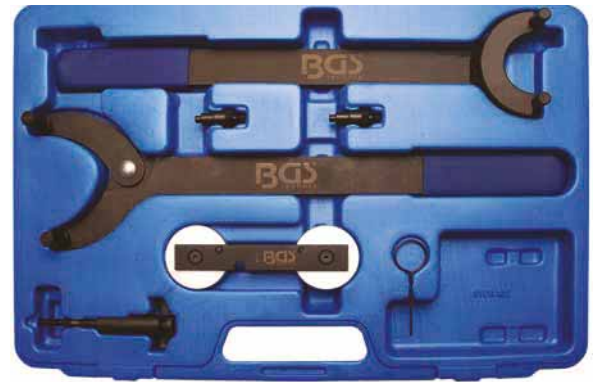

Engine Timing

Item #
8261

Engine Timing Tool Set | for VAG 2.4, 2,8, 3.0 FSI

- for checking and setting the camshaft timing
- suitable for Audi V6, V8 and V10-engines with chain
- camshaft locking tool to be used as OEM T40070
- crankshaft locking pin to be used as OEM T40069
- chain tensioner locking pin to be used as OEM T40071



Item #
66210

Engine Timing Tool Set | for VAG 2.5, 4.9D, TDI PD

- suitable for VW T5 as of 2004, Touareg and Phaeton since 2003 with 5-cylinder and 10-cylinder engines with engine codes: AXD, AXE, BAC, BLJ, BLK, BNZ, BPC, BPD, BPE
- camshaft locking tool for review and adjustment, suitable for 5- and 10-cylinder engines, to be used as OEM T10193
- camshaft locking tool for review and adjustment of 10-cylinder engines, to be used as OEM T10194
- clamping device for removal and replacement of the camshaft wheels of 5- and 10-cylinder engines, to be used as OEM T10199, T10199/1
- special socket for rotating the crankshaft of 5-cylinder engines, to be used as OEM T10225
- crankshaft locking wrench for 5-cylinder engines, to be used as OEM T10226
- tensioner wrench



Item #
8443

Engine Timing Tool Set | for Audi A4, A6, A8

- suitable for Audi A4, A6, A8 with engine codes ASN, AVK, BBJ
- for timing belt replacement and repair work on the engine
- easy mounting of the belt as camshaft and crankshaft are fixed
- 2 camshaft locking tool, to be used as OEM T40030
- crankshaft locking tool, to be used as OEM T40026
- tensioner pulley wrench, to be used as OEM 3387
- socket for basic adjustment of the camshaft adjuster, to be used as OEM T40028
- pins for clamping element, to be used as OEM T40011



Item #
8299

Camshaft Locking Tool | for VAG 5- and 10-Cylinder engines

- suitable for VW Phaeton 2003, Touareg as of 2003, Transporter as of 2004 with 5- and 10-cylinder diesel engines
- to be used as OEM T10193 or T10194
- for adjusting the camshaft when checking and repairing the engine
- no twisting of camshafts, allows precise adjustment



Item #
8279

Tooth Belt Tool Set | for VAG

- set for working and locking the tooth belt tensioner rolls
- is needed when changing the tooth belt and during general engine repair jobs
- for the most common VW, Audi, Seat, Skoda fuel and Diesel engines
- spanners can be used as a counterholder
- no displacing of tooth belt tension when tightening the nut
- 3 tensioner pulley wrenches in different lengths and offset shapes to be used as OEM T10020, V159, 3387
- 3 locking pins for tooth belt spanners:
 - 1.6 mm used as OEM T40011
 - 2.5 mm used as OEM T03006
 - 4 mm used as OEM T10060A



Item #
8241

Engine Timing Tool Set | for VAG | 7 pcs.

- suitable for 2.0 L FSI and TFSI engines, e. g. Golf, Touran, Audi A3, engine codes: AWA, BMB, AXW
- alignment pin, to be used as OEM T10060A
- locking pin, to be used as OEM T10115
- locking pin, to be used as OEM T40011
- chain tensioner, to be used as OEM 3366
- camshaft locking tool, to be used as OEM T10252
- tensioning screw, to be used as OEM T10092
- pin-type face wrench, to be used as OEM T10020



Item #
8219

Engine Timing Tool Set | for VW | 5 pcs.

- for engine codes AAB, AJA, BJJ, BJK, BJL, BJM
- for VW Transporter 2.4D (95-03), Crafter 2.5TDI (06-09) and LT models
- to be used as OEM T10025, 2065A, 2064



Item #
8216

Engine Timing Tool Set | for VAG

suitable for the following VAG models with 1.2 L 3-cylinder engines:

- Volkswagen:
 - Polo 1.2 L, 6V, 3-cylinder, engine codes AWY, BMD, BBM
 - Polo 1.2 L, 12V, 3-cylinder, engine codes AZQ, BME, BZG, CGPA, CGPB,
- Skoda:
 - Fabia 1.2 L, 6V, 3-cylinder, engine codes AWY, BMD
 - Fabia 1.2 L, 12V, 3-cylinder, engine codes AZQ, BME, BZG, CEVA, CGPA, CGPB
 - Rapid 1.2 L, 12V, 3-cylinder engine code CGPC
 - Roomster 1.2 L, 12V, 3-cylinder, engine codes BME, BZG, CGPA
 - Praktik Rapid 1.2 L, 12V, 3-cylinder, engine codes BZG, CGPA
- Seat:
 - Ibiza 1.2 L, 12V, 3-cylinder, engine codes AZQ, BME, BXV, BZG, CGPA, CGPB
 - Cordoba 1.2 L, 12V, 3-cylinder, engine codes AZQ, BME, BXV
- camshaft locking tool, to be used as OEM T10123
- camshaft locking tool, to be used as OEM T10120
- crankshaft locking tool, to be used as OEM T10121



Item #
8158

Crankshaft Locking Tool | for VW Touareg / Phaeton from 2003

- suitable for VW Touareg manufactured before 2003, Phaeton manufactured before 2003 with 10-cylinder diesel engine
- crankshaft locking tool, for locking the crankshaft when adjusting engine timing, to be used as OEM T10195
- adjusting bolts, for mounting of the engine control module (wheels cassette), to be used as OEM T10200
- supplementary set for BGS 8443





Item #
8769

Engine Timing Tool Set | for VAG 2.8, 3.0 TFSi

- for checking and setting the engine timing
- suitable for Audi 2.8 / 3.0 TFSi, petrol direct injection engines in Audi A6 as of 2005
- crankshaft locking pin, to be used as OEM T40069
- camshaft adjusting tool, to be used as OEM T40133
- chain tensioner locking tool, to be used as OEM T40071
- camshaft adjuster pre-tensioning tool, to be used as OEM T10172
- bolts for pre-tensioning tool (4 pcs.), to be used as OEM T10172/2
- two-pin wrench, to be used as OEM 3212
- crankshaft pulley bolt adaptor, to be used as OEM T40058
- special socket, to be used as OEM T10035



Item #		
8839		

Engine Timing Tool Set | for VAG 1.2 TSI, TFSI | 4 pcs.

- for adjusting the timing during replacement of the timing chain, renewing of the cylinder head gasket, etc.

suitable for the following models:

- VAG 1.2 TSI/TFSI with engine codes CBZA, CBZB, CBZC
- Audi models A1 and A3
- VW New Beetle, Caddy, Golf, Jetta, Polo, Touran
- Skoda Fabia, Fabia Combi, Wildwasser, Oktavia, Roomster, Yeti
- Seat Altea, Ibiza, Leon, Toledo
- crankshaft locking tool, to be used as OEM T10340
- camshaft locking tool, to be used as OEM T10414
- guide pin, to be used as OEM-T10341

Item #
8882



Engine Timing Tool Set | for VAG 1.0, 1.2, 1.4

- for adjusting and checking the engine timing

suitable for the following VAG (EA211) engines with timing belts:

- 1.0 MPI 3-cylinder, engine codes CHYA
- 1.0 TSI 3-cylinder, engine codes CHZE, CHZC, CHZA, CHZB, CHZC, CHZD, CHZJ
- 1.2 TSI 4-cylinder, engine codes CJZB, CJZC, CYVA, CJZA, CJZD, CYVB
- 1.4 TSI 4-cylinder, engine codes CZCC, CMBA, CZCA, CHPA, CPTA (with ACT), CZDA, CVNA, CZEA (with ACT)
- crankshaft locking bolt, to be used as OEM T10340
- camshaft adjusting plate, to be used as OEM T10477
- camshaft sprocket locking tool, to be used as OEM T10476
- tensioner adjusting wrench, to be used as OEM T10499
- camshaft adjusting plate, to be used as OEM T10494
- assembly tool, to be used as OEM T10487



Item #
8922

Engine Timing Tool Set | for VAG 1.8 I, 2.0 FSI, TFSI

- for checking and setting the engine timing
- suitable for 1.8 / 2.0L VAG engines with engine codes BYT, BZB, CABA, CABB, CABD, CADA, CAEA, CAEB, CAWA, CAWB, CBFA, CCTA, CCZA, CCZB, CCZC, CCZD, CDAA, CDAB, CDHA, CDHB, CDNB, CDNC, CDND, CESA, CETA, CFKA, CFFA, CGYA, CHHA, CHHB, CJBA, CJEB, CJKA, CJKB, CJSA, CJSB, CNCD, CPLA, CPSA
- built e.g. into Audi A4 / A5 (as of 2008) / A6 (as of 2012)
- crankshaft counterholding tool, to be used as OEM T10355
- crankshaft thrust piece, to be used as OEM T10368
- crankshaft thrust piece, to be used as OEM T10354
- camshaft locking bolts (4x), to be used as OEM T40196
- chain tensioner locking clips (2x), to be used as OEM T40267
- chain sprocket locking tools (2x), to be used as OEM T40271, T20208
- camshaft control valve tool, to be used as OEM T10352
- camshaft control valve tool, to be used as OEM T10352/1
- camshaft control valve tool, to be used as OEM T10352/2
- belt tensioner locking pin, to be used as OEM T10060A
- tensioner locking pins (2x), to be used as OEM T40011
- oil pump tensioner locking tool, to be used as OEM T40265

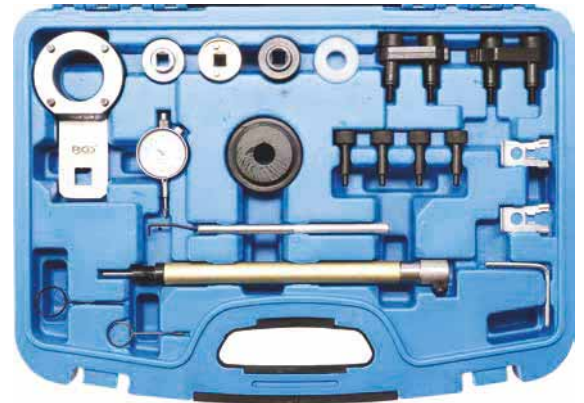

Item #
8924

Engine Timing Tool Set | for VAG 1.8, 2.0 | FSI, TFSI

- for checking and setting the engine timing
- suitable for 1.8 / 2.0L VAG (EA888), with engine codes BYT, BZB, CABA, CABB, CABD, CADA, CAEA, CAEB, CAWA, CAWB, CBFA, CCTA, CCZA, CCZB, CCZC, CCZD, CDAA, CDAB, CDHA, CDHB, CDNB, CDNC, CDND, CESA, CETA, CFKA, CFPA, CGYA, CHHA, CHHB, CJBA, CJEB, CJKa, CJKB, CJSa, CJSB, CNCD, CPLA, CPSA
- built e. g. into Audi A4 / A5 (as of 2008) / A6 (as of 2012)

- crankshaft thrust piece, to be used as OEM T10368
- crankshaft thrust piece, to be used as OEM T10354
- camshaft locking bolt (4x), to be used as OEM T40196
- chain tensioner locking clip (2x), to be used as OEM T40267
- chain sprocket locking tools (2x), to be used as OEM T40271, T20208
- camshaft control valve tool, to be used as OEM T10352
- camshaft control valve tool, to be used as OEM T10352/1
- camshaft control valve tool, to be used as OEM T10352/2
- belt tensioner locking pin, to be used as OEM T10060A
- tensioner locking pins (2x), to be used as OEM T40011
- oil pump tensioner locking tool, to be used as OEM T40265

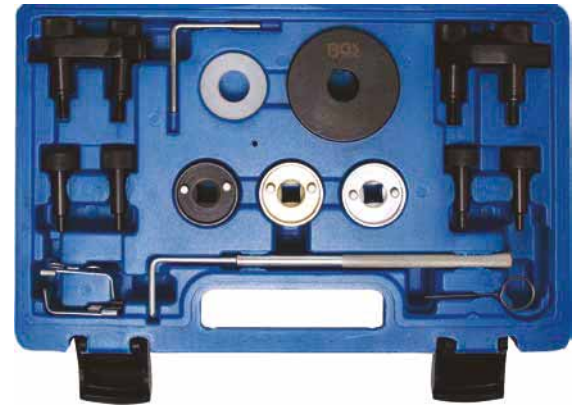

Item #
8928

Engine Timing Tool Set | for VAG 2.0 TFSI

- for checking and setting the engine timing on VAG 2.0L TFSI engines with code CAEB as of 2009

- crankshaft counterholding tool, to be used as OEM T10355
- crankshaft thrust piece, to be used as OEM T10368
- camshaft locking bolts (4x), to be used as OEM T40196
- chain tensioner locking clips (2x), to be used as OEM T40267
- chain sprocket locking tools (2x), to be used as OEM T40271
- camshaft control valve tool, to be used as OEM T10352



Item #
8951

Camshaft Central Valve Sockets | for VAG 1.8 / 2.0 TFSI / TSI

- for disassembly / assembly of 4/3-way central valve of camshaft adjustment
- suitable for 1.8 & 2.0 L 4-cyl. injection & direct injection engines with timing chain, installed in the following models:
 - Audi A3, A4, A5, Q5, TT
 - Seat Altea, Leon, Toledo, Exeo
 - Skoda Octavia II, Superb II, Yeti
 - Volkswagen Eos, Golf, Jetta, Passat, Scirocco, Sharan, Tiguan
- 3 special sockets, 10 mm (3/8") drive:
 - special socket for camshaft control valve, to be used as OEM T10352
 - special socket for camshaft control valve, to be used as OEM T10352/1
 - special socket for camshaft control valve, to be used as OEM T10352/2



Item #
9064

Camshaft Central Valve Sockets | VAG 1.8 / 2.0 TFSI

- used for removal and installation of 4/3-way central valve on the camshaft adjustment
- suitable for VW Passat, Audi A3, A4, A5, Q5 1.8 l and 2.0 litre engines with chain drive
- to be used as OEM T10352 / T10352/1



Item #
8565



Engine Timing Tool Set | for VAG FSI, TSI 1.4, 1.6 with Timing Chain

- to check and the adjust the camshaft timing
- required when replacing timing chains
- suitable for VAG FSI and TFSI 1.4L and 1.6L engines

suitable for the following models:

- Audi A3 (03-10)
- Seat Ibiza, Leon, Altea
- Skoda Octavia (04-09), Fabia (07-09), Superb (09-10), Roomster (06-09)
- VW Golf (03-09), Golf Plus (05-09), Jetta (06-09), Passat (05-09), Polo (02-08), Scirocco (09-10), Tiguan (07-09), Touran (03-09), Eos (06-09)
- engine code AXU, BLG, BAG, BMY, BKG, BMK, BLF, CAVA, BLN, CAVB, BLP, CAVC, CAVE, CAVF, CAVD, CAXA, CAXC, CDGA, BTS

- camshaft locking tool, to be used as OEM T10171
- setting gauge holder, to be used as OEM T10100
- crankshaft locking tool, to be used as OEM T10340
- tensioner locking tool, to be used as OEM T40011



Item #	Description
62625	Engine Timing Tool Set for VAG FSI, TSI 1.4, 1.6 with Timing Chain
62625-1	Crankshaft Locking Tool for VAG FSI / TFSI for BGS 62625

Engine Timing Tool Set | for Audi 2.4, 2.8, 3.0 TFSI

- for setting the engine timing when replacing the cylinder head gasket, camshaft, etc.
- suitable for e. g. Audi A6, Q5
- 2 camshaft locking tools, to be used as OEM T40133
- crankshaft locking pin to be used as OEM T40069
- chain tensioner locking tool, to be used as OEM T40071
- crankshaft turning tool, to be used as OEM T40058

Item #		1 6
66211		



Front Mask Removing Tool | for Audi A4 | 2 pcs.

- for moving the front mask in service position e. g. Audi A4, Passat as of 1997
- for changing the toothed belt or replacing the water pump
- to be used as OEM T10093

Item #	
8023	



Camshaft Guide | for VW, Audi | 170 mm

- for VW and Audi
- engine codes: AAA - ABV - AES - AGZ - AMY - AZX

Item #	
8122	



Tensioner Pulley Wrench | for VW/Audi engines

- 5-way adjustable and 180° pivotable handle
- can also be used in hard-to-reach areas
- especially for timing belts on 4- and 5-cylinder VAG engines and VW T4 servo pumps
- extra flat type

Item #	
8150	



Camshaft Locking Tool | for Audi, VW

- is needed for changing of the tooth belt on Audi and VW with the following engines: AUDI A4 2.4 2.8 1997 - 2002, A6 2.4 1997 - 2002, A6 2.8 1997 - 2002, A8 2.8 1997 - 2002, S4 2.7 Turbo 1997 - 2001 or Volkswagen with ACK, ALG, APR, AQD engines and Passat 2.4 1996 - 2002, Passat 2.8 30v 1996 - 2001
- avoids distortion of the camshaft during tooth belt assembly
- allows easy and precise assembly of the tooth belt
- suitable crankshaft locking tool available under BGS 8155-6



Item #
8232

Camshaft Locking Tool | for Audi, VW

- is needed for changing of the tooth belt on Audi and VW with 2-valve V6 engines e.g. Audi 80, 90, A4, A6 1994-97 ABC, AFC engine
- avoids distortion of the camshaft during tooth belt assembly
- with the fixing hook a tight fit is guaranteed
- allows easy and precise assembly of the tooth belt



Item #
8233

Camshaft Locking Tool | for Audi, VW

- is needed for changing of the tooth belt on Audi and VW with the following engines: V8 3.3L to 4.2L 5-valve engines in Audi A6, A8 with e.g. engine codes AKB, AUX, AYS, AQJ, ARS, ART, AWN, BBD, BCY, BFM 1998 - 2003 and VW Touareg and Phaeton
- avoids distortion of the camshaft during tooth belt assembly
- allows easy and precise assembly of the tooth belt
- to be used as OEM T40005



Item #
8234

Serpentine Belt Tool | for VAG

- for VAG engines without tensioner pulley
- tensioning is carried out through spring loaded alternator
- wrench allows to press the alternator against the spring tension and change the poly-V-belt without problems
- knurled bolts prevent slipping-off hazard



Item #
8239

Special Crankshaft Rotation Tool | for VAG 5-Cylinder Engines

- no twisting of camshafts- necessary for crankshaft adjustment and use as a lever
- suitable for all 5-cylinder VW diesel engines
- used in e. g. Touareg as of 2003 and Transporter as of 2004
- fixing screw allows easy mounting on crankshaft
- to be used as VAG OEM T10225

Item #
8249



Crankshaft Seal Ring Mounting Tool | for VAG 1.4 & 1.6 16V

- for mounting of the transmission-side radial sealing ring
- installing the sealing ring without this tool can cause leaks, destruction of the new sealing ring and bad engine running
- suitable for VAG vehicles with 1.4 & 1.6 16V engines, installed in e. g. Seat Arosa, Ibiza, Cordoba, Leon, Toledo, Inca, Skoda Fabia, Octavia, Roomster, VW Lupo, Polo, Golf, Bora, Beetle, Caddy
- to be used as OEM T10017

Item #
8334



Crankshaft Seal Ring Mounting Tool | for VAG Petrol & Diesel Engines

- for mounting of the transmission-side radial sealing ring
- an assembly test of the sealing ring without this tool can cause leaks, destruction of the new sealing ring and poor engine running
- suitable for VAG vehicles
VW Golf, Touran and Audi A3, A4
1.4i Turbo, 1.4 & 1.6 petrol direct injection,
1.9 / 2.0 SDI, 2.0 Common Rail Diesel engine
- to be used as OEM T10134

Item #
8335



Engine Timing Tool Set | for Audi, VW V6 TDI

- for locking of crankshaft and camshaft when working on the engine timing, e. g. changing of the tooth belt, disassembly of the cylinder heads etc.

suitable for the following models

- VW Passat 2.5 V6 TDI
- Audi A4 2.5 V6 TDI
- Audi A6 2.5 V6 TDI
- Audi A8 2.5 V6 TDI
- Skoda Superb 2.5 V6 TDI
- engines codes: AFB, AKN, AKE, AYM, BAU, BCZ, BDG, BDH, BFC
- crankshaft locking pin, to be used as OEM 3242
- camshaft locking plates, to be used as OEM 3458
- crankshaft locking pin also individually available as BGS 8155-6



Item #	
8275	

Camshaft Locking Tool | for VAG | adjustable | 12V / 30V

- wide application range because of adjustable camshaft locking tool, to be used as OEM 3391 or OEM 3243
- crankshaft locking bolt to be used as OEM 3242
- is needed for changing the tooth belt on Audi and VW with following engines:
 - AUDI A4 2.4 2.8 1997 - 2002
 - AUDI A6 2.4 1997 - 2002, A6 2.8 1997 - 2002
 - AUDI A8 2.8 1997 - 2002, S4 2.7 Turbo 1997 - 2001
 - Volkswagen with ACK, ALG, APR, AQD engines
 - VW Passat 2.4 1996 - 2002, Passat 2.8 30v 1996 - 2001
 - 2 valves V6 engines e.g. Audi 80, 90, A4, A6 1994 - 1997 ABC, AFC engine
- avoids distortion of the camshaft during tooth belt assembly
- allows easy and precise assembly of the tooth belt



Item #
8522

Camshaft Setting Tool | for Audi V8 4.2

- for adjusting the camshafts
- to be used as OEM T40047
- ensures correct setting of the hall sensor wheel, an incorrect setting may cause bad idle and lazy response lead
- suitable for cars with 4.2 liter V8 engines: AUDI A6 (2005 - 2006), A8 (2004 - 2006), Quattro (2003 - 2005), S4 (2004 - 2009), VW Phaeton (2004 - 2006) with engine codes: BNK - BFM - BGK - BAS - BHF - BGH



Item #
8531

Camshaft Locking Tool | for Audi 8-Cylinder Engines

- suitable for Audi A4 2001> and A6 1998> with 8-cylinder engines
- for checking and adjusting the engine timing
- to be used as OEM T40046

Item #
8532

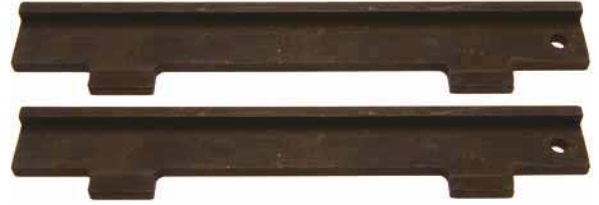

Crankshaft Rotating Tool | for VAG

- facilitates turning the crankshaft for e.g. checking the engine timing
- suitable for Audi A6 2005>, Audi A8 2003> with 6- and 8-cyl. engines 2.4 L, 3.2 L FSI, 6 - and 8-cyl. TDI common rail
- to be used as OEM T40058

Item #
8555



Crankshaft Locking Tool | for VAG 5- and 10- cylinder

- suitable for VW T5 as of 2004, Touareg and Phaeton as of 2003 with 5-cylinder and 10-cylinder engines
- camshaft locking tool for review and adjustment, suitable for 5- and 10-cylinder engines
- to be used as OEM T10199 / OEM T10199/1

Item #
8690



Flywheel Locking Tool | for VAG 1.9 TDI

- for locking the flywheel
- to be inserted into the bore of the transmission housing
- fits on VW, Skoda, Seat with 1.9l diesel engines
- e. g. for motor recognition 1Z, AFN, AHU, ALE, AVG

Item #
8751



Crankshaft Mounting Tool | for VAG 6- and 8-cylinder TDI

- for fitting the camshaft in the cylinder head
- suitable for the following VAG models: VW Tiguan 2008 / Passat CC 2009 / Touareg 2003 / Phaeton 2003, Audi A3 2004 / A4 2001 / A4 2008 / A5 2008 / Q5 2008 / A6 2005 / Q7 2007 / A8 2003
- 6-cylinder TDI common rail 2.7 & 3.0 4-valve engines
- 8-cylinder TDI common rail 4.0 4-valve engines
- to be used as VAG OEM T40095

Item #
8871



Timing Chain Adjusting Wrench | for VAG

- used for tensioning the timing chain
- suitable for Audi A6 from 2005 4.2 l direct injection 8-cyl., 4 valve
- to be used as OEM T40079



Item #
8878

Camshaft Locking Tool | for VAG W8 and W12

- for aligning the camshafts
- suitable for V6 3.2L FSI R32 W8 and 6.0L W12
- 2 alignment rulers
- to be used as OEM T10068 & T10068A



Item #
8883

Camshaft Sprocket Locking Tool | for VW 1.8 / 2.0 TFSI

- for locking the inlet and exhaust camshafts when loosening the central screws



Item #
8940

Camshaft Spacers | for VAG

- used for locking the sliding pieces on the camshaft
- suitable for 4-cyl. petrol direct injection, 2.0 turbo, 4 valve engines e. g. Audi A4 2008>, Audi Q5 2009>
- to be used as OEM T40191



Item #
8946



Camshaft Sprocket Locking Tool | for VAG 1.0

- for locking the camshafts in the adjustment position
- is needed when checking and adjusting and adjusting the engine timing
- can be used for following car types: Seat Mii 1.0 (3-cylinder), Skoda Citigo 1.0 (3-cylinder), Volkswagen Up 1.0 (3-cylinder)
- motorcodes CHYA, CHYB, CPGA
- to be used as OEM T10476

Item #
8977



Guide Bolt Set | for VW T5 Front Mask

- are used instead of the front panel mounting bolts
- allows the panel to be slid away from the engine without disconnecting all fluid pipes etc.
- required for e. g. works on the camshaft drive
- suitable for Volkswagen T5 (as of 2004)
- includes 4 bolts M8 x 1.25, Ø 13 mm, length 200 mm
- to be used as OEM T10228

Item #
9204



Camshaft Adaptor Socket | for VAG 1.8 / 2.0 TFSI

- for rotating and holding the camshaft adjuster when working on the timing chain
- suitable for 1.8 / 2.0 TFSI (3rd generation) built in the following models, e. g.:
- Audi A3 (as of 2012), A4 (as of 2008), A5 (as of 2009)
- A5 Coupe (as of 2008), Q5 (as of 2008)
- Seat Alhambra (as of 2008), Exeo (as of 2009), Altea (as of 2009)
- to be used as OEM T40266

Item #
9209



Camshaft Mounting Tool Set | for VAG and Porsche

- for installation camshafts in the correct position
- required when installing new or existing camshafts, an installation without this tool can cause damage to the camshaft bearing bridge and cylinder head
- suitable for the following diesel vehicles (TDI CR) as of 2003 Audi, Porsche, Seat, Skoda, Volkswagen with 1.2 1.6 2.0 2.7 3.0 4.0 4.2 Common-Rail engines
- engine codes: ASB, ASE, BKN, BKS, BMK, BNG, BPP, BSG, BTR, BUG, BUN, BVN, CAAA, CAAB, CAAC, CAAD, CAAE, CAGA, CAGB, CAGC, CAHA, CAHB, CAMA, CAMB, CANA, CANB, CANC, CAND, CAPA, CARA, CASA, CASB, CASC, CASD, CATA, CAYA, CAYB, CAYC, CAYD, CAYE, CBAA, CBAB, CBAC, CBBA, CBBB, CBDA, CBDB, CBDC, CCFA, CCFC, CCHA, CCHB, CCLA, CCMA, CCWA, CCWB, CDBA, CDCA, CDSB, CDTA, CDTB, CDUC, CDUD, CDYA, CDYB, CDYC, GEGA, GEXA, CFCA, CFFA, CFFB, CFFD, CFFE, CFGB, CFGC, CFGD, CFHA, CFHB, CFHC, CFHD, CFHE, CFHF, CFJA, CFWA, CGKA, CGKB, CGLA, CGLB, CGLC, CGLD, CGLE, CGQB, CJAA, CJCA, CJCB, CJCC, CJCD, CJGA, CJGC, CJGD, CJMA, CKDA, CKTB, CKTC, CKUB, CKUC, CKVB, CKVC, CLAA, CLAB, CLCA, CLCB, CLJA, CLLA, CLNA, CLZB, CMEA, CMFA, CMFB, CMGB, CMHA, CNEA, CNFA, CNRB, CRCA, CSHA, M05/9D (CAS), M05/9E, M05/9E (CRCA), M05/9E (CRCB)
- mounting device including pre-assembled parts, to be used as OEM T40094
- camshaft retaining clamp, to be used as OEM T40095
- 2 alignment clamps, to be used as OEM T40096 & T40096/1
- 4 camshaft brackets for mounting device, to be used as OEM T40094/1, T40094/2, T40094/9, T40094/10
- locking tool for camshaft holder, to be used as OEM T40094/11



Item #
9319

Engine Timing Tool Kit | for VAG | 3 pcs.

- suitable for VAG 2.0 liter TDI and some 1.9L TDI with oval crankshaft wheel
- crankshaft locking tool, to be used as OEM T10100
- locking bolt for pump, to be used as OEM 3359
- locking plate for idler, to be used as OEM T10008



Item #
62640



Engine Timing Tool Set | for VAG | 3 pcs.

- suitable for VAG 1.2 - 1.4 - 1.9l TDI engines with round crankshaft wheel
- crankshaft locking tool, to be used as OEM T10050
- locking bolt for pump, to be used as OEM 3359
- locking plate for idler, to be used as OEM T10008



Item #
62641



Crankshaft Timing Belt Pulley Locking Tool | for VAG

- suitable for VAG 2.0L TDI and some 1.9L TDI with oval crankshaft wheel
- to be used as OEM T10100

Item #
62642



Crankshaft Timing Belt Pulley Locking Tool | for VAG

- suitable for VAG 1.2 - 1.4 - 1.9l TDI engines with round crankshaft wheel
- to be used as OEM T10050

Item #
62643



Holding Wrench | for Crankshaft Belt Pulley | for VW, Seat 1.6 l

suitable for the following models:

- VW Lupo, Polo, New Beetle, Golf, Bora Caddy
- Seat Ibiza, Cordoba
- engine codes: ARC, AVY

- length: 770 mm

Item #
66701



Belt Pulley Counterholding Wrench

- suitable for VW 1.4 / 1.6 / 2.0 l engines (engine codes ADX, AEA, AEE, AEH, AEX, AFH, AFK, AGP,AGR, AHW, AJM, AKL, ALN, AMF, ANA, ANY, APE, APF,ARM, ATJ, AUA, AWH)
- for counterholding the belt pulley of 4-valve engines with pin diameter 11.5 mm
- also for counterholding the belt pulley of 2-valve engines

suitable for the following models:

- VW: Beetle, Bora, Caddy, Golf, Lupo, Polo, Sharan, Touran, Transporter
- Audi: A2 / A3 / A4 / A6, TT
- Skoda: Fabia, Octavia, Superb

Item #
66703



Tensioner Pulley Wrench | 12-point | Ø 32 mm

- for moving the automatic tensioner pulley when replacing the tooth belt

suitable for the following models:

- Audi 100 manufactured starting from 1991, A4, A6 2.5 TDI 5 cylinder
- VW Polo Diesel, Lupo as of 1999, LT and T4 2.5 TDI
- comparable engines of other manufacturers (Volvo etc.)



Item #
66720



Tooth Belt Tensioner Pulley Wrench

- extra flat type
- 185 mm x 200 mm x 20,5 mm



Item #
66725



Setting Gauges | for VAG Pump-Nozzle Unit on 3- and 4-Cylinder Engines

- for adjusting the pump-nozzle units
- suitable for 3- and 4-cylinder engines and for pump-nozzle units with old and new solenoid valve nut

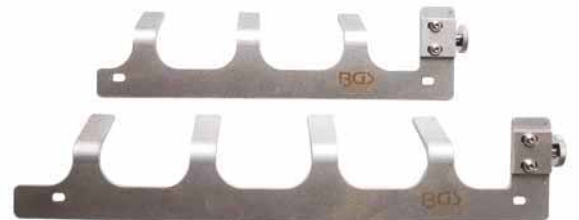

Item #
68341

High Pressure Pump Sprocket Extractor | for VAG 2.0 TDi CR

- for removing the high pressure pump pulley on 1.6 / 2.0l and 6-cyl. TDI common rail engines
- can be used as OEM T40064



Item #
9206

Driving Toothed Wheel Locking Tool | for VAG 3.6l FSi

- for locking the drive sprocket of high the pressure pump
- is required when adjusting the valve timing
- suitable for VAG 3.6l 6-cylinder 4-valve engines, built in VW Passat (357) (3C2) (3C5) starting from 2006, VW Touareg (7L6) (7LA) starting from 2006, Audi Q7 (4LB) starting from 2007
- engine codes: BLV, BHL, BHK
- to be used as OEM T10332

Item #
9418



Driving Toothed Wheel Locking Tool | for VAG 3.6l FSi

- for locking the drive sprocket of the high pressure pump
- is required when adjusting the valve timing
- suitable for VAG 3.6L FSi 6-cylinder 4-valve engines installed in VW Passat (357) (3C2) (3C5) as of 2006, VW Touareg (7L6) (7LA) as of 2006, Audi Q7 (4LB) as of 2007
- engine codes: BLV, BHL, BHK
- to be used as OEM T10363

Item #
9492



Camshaft Timing Tool Set | for VAG | 3 pcs.

- to secure the camshaft during inspection and adjusting the valve control times
- suitable for 1.2 / 1.4 TSi / TFSi engines with active cylinder management ACT or COD
- engine codes: CPTA, CZEA
- e. g. installed in the following models:
Audi A1 (2013-), A3 (2013-), Q3 (2014-)
VW Passat (2012), Golf (2012-), Polo (2015-)
Seat Leon (2014-), Ibiza (2013-)
Skoda Superb (2015-)
- camshaft adjusting tool, to be used as OEM T10504
- camshaft adjusting pin, to be used as OEM T10504/1
- camshaft inspection pin, to be used as OEM T10504/2

Item #
9493



Crankshaft Locking Tool | for VAG 10 cylinder engines

- crankshaft locking tool with aligning pin
- to be used as OEM T10226
- suitable for e. g. VW Tourag, Phaeton

Item #
8622



Engine Timing Tool Set | for Volvo T6

- for adjusting and checking the engine timing
- suitable for Volvo S80, XC90, XC60, XC70 3.0T, 3.2 with T6 engine as of 2007
- crankshaft rotating tool, to be used as OEM 9997257, 303-1219
- camshaft alignment tool, to be used as OEM 9997261 303 -1223
- tool for assembling and disassembling the end cover, to be used as OEM 9997263, 303-1225
- tool for assembling and disassembling the end cover, to be used as OEM 9997264, 303-1226
- T-star socket, T60, 12.5 mm (1/2") drive, to be used as OEM 9997272
- mounting bracket, to be used as OEM 9997271
- end cover adjusting tool, to be used as OEM 9997266
- end cover adjusting tool, to be used as OEM 9997267



Item #
8527

Engine Timing Tool Set | for Volvo 4-, 5-, 6-Cyl. Engines up to YOM 06

- for alignment of the cam- and crankshafts
- also for correct installation of the camshafts over the cam cover
- suitable for 4-, 5- and 6-cyl. twin cam engines (not 3.2l) up to 2006 on Volvo models: 700, 800, 850, 900, 960, C70, S40, S60, S70, S80, S90, V70 -2000, V70XC, XC70, V90, XC90
- 2-piece camshaft cover tool, to be used as OEM 9995454
- crankshaft locking tool, to be used as OEM 9995452
- camshaft alignment tool, to be used as OEM 9995451
- holder, to be used as OEM 9995453
- 2x 110 mm and 2x 85 mm screws

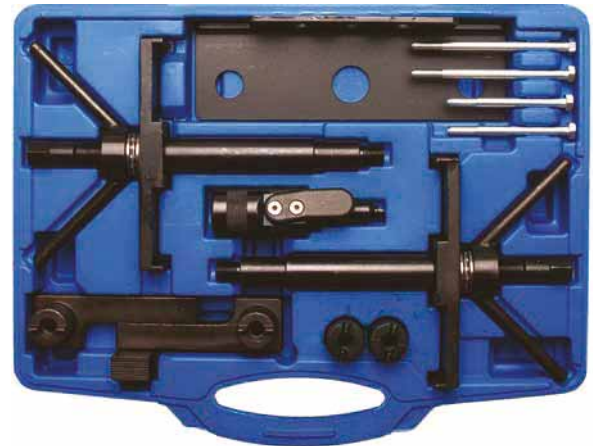

Item #
8562

Engine Timing Tool Set | for Volvo B4204

- for adjusting and checking the engine timing
- required for e.g. working on valve drive and renewing the cylinder head gasket
- suitable for Volvo B4204 engine (8-speed gearbox)
- belt pulley counterholding tool, to be used as OEM 9997495
- crankshaft wheel puller, to be used as OEM 9997493
- radial seal ring mounting tool, to be used as OEM 9997496
- camshaft sprocket tool, to be used as OEM 9997497
- camshaft alignment tool, to be used as OEM 9997490



Item #
8998



Double Hook with Joint for Removal of Shaft Gaskets

- 320 mm long lever arm for fast and easy disassembly of radial sealing rings
- lever adjustable in 5 positions of up to 45°
- hardened pulling lever for long product life time
- anti-slip coated handle

Item #
118



Reaction Wrench, for offset-Type Pulley | 300 mm

- wrench for safe blocking of deep-drawn water pump belt pulleys through mounting screws
- can be used for many VW + Audi engines with A/C
- can also be used for loosening stuck nuts of the water pump belt pulley
- length: 300 mm

Item #
1747



Camshaft Disc Puller | for VAG

suitable for:

- VW Passat, Phaeton, Touareg
- Skoda Superb
- Audi A4, A6, A6 Quattro, A8, Allroad, Cabrio, RS4, RS6, S6, S8
- engines / engine codes:
 - 3.0 L V6 30V: ASN, AVK, BBJ
 - 3.7 L V8 AKC, AQQ
 - 4.2 V8 ANK, AQF, AQH, AQJ, ARS, ARU, ASG, AWN, AWU, AVN, AVP, AXQ, BCY, BGH, BGJ, BHX
 - 2.5 L TDI V6 Diesel AFB, AKE, AKN, AYM, BAU, BCZ, BDG, BDH, BFC

Item #
1767



Fan Hub Wrench Set

- for holding the visco-clutch drive shaft in BMW and Ford
- allows the technician to hold the water pump pulley in place while loosening the radiator fan
- allows removal of the visco-coupling on the cooling fan

Item #
1763



Fan Hub Wrench Set | 4 pcs.

- 32 mm x 270 mm for holding the Visco-clutch drive shaft in BMW and Ford
- 36 mm x 270 mm for holding the Visco-clutch drive shaft in Ford, Opel and GM
- 41 mm x 270 mm for moving the waterpump in Opel and GM in order to span the drive belt in OHC engines
- 46 mm x 270 mm for moving the waterpump in Opel and GM in order to span the drive belt in OHC engines



Item #	Description
1684	Fan Hub Wrench Set 4 pcs.
1772	Fan Hub Wrench for BMW, Ford 32 mm
1774	Fan Hub Wrench for Ford, Opel, GM 36 mm
1682	Fan Hub Wrench for GM, Opel 41 mm
1683	Fan Hub Wrench for Opel, GM 46 mm



Flywheel Locking Tool | for Citroën, Fiat, Peugeot

- for Citroën, Fiat, Peugeot
- also suitable for identical engines in BMW, Renault, Mercedes-Benz
- flywheel locking tool, to be used as OEM BMW 119260, Renault MOT 582-01, PSA 0153A, 6012T, 9765.54, Fiat 1860161000, 1867030000, Mercedes-Benz 607589014000

Item #
1771



Crankshaft / Equaliser Flange Puller

- ideally suited for disassembly and assembly of balancer shafts and crank shaft flanges
- all-purpose, incl. 9 adaptors
- 1 puller plate, 20 mm holder
- 12 screws, 3 pcs. each: 3/8"NC16 x 57 mm - 3/8"NC24 x 57 mm - M6 x 1.0 x 60 mm - M8 x 1.25 x 60 mm
- 1 centre bolt 10 mm
- 9 adaptors:
 - M12 x 1.5 - 3/8"NC16
 - M14 x 1.5 - 3/8"NC16
 - M16 x 2.0 - 3/8"NC16
 - 1/2" x NC20 - 3/8"NC16
 - 9/16" x NC18 - 3/8"NC16
 - 7/16" x NC20 - 3/8"NC16
 - 3/4" x NC16 - 3/8"NC16
 - 5/8" x NC18 - 3/8"NC16
 - 3/8" x NC16 - 3/8"NC16
- material: carbon steel
- surface finish: burnished

Item #
7711



Water Pump Disassembly Tool | for VW

- suitable for VW T5, Touareg 2.5D
- gear wheel puller, for disassembling of waterpump gear wheel, to be used as OEM T10222A
- waterpump puller, for disassembling of waterpumps, to be used as OEM T10221A
- special key, for counterholding the crankshaft when loosening the waterpump's gear wheel screw, to be used as OEM T10225



Item #
8221

Radial Seal Dismantling and Assembly Set

- facilitates a damage-free mounting of radial sealing rings
- universally usable for radial sealing rings with Ø 21.5 - 64 mm
- suitable for all pressed radial sealing rings such as on camshafts, crankshafts, balancer shafts, ect.
- 4 spacers to compensate the differences in length of central screw
- 7 press sleeves for mounting of radial sealing rings
- 7 adaptor rings for normal central bolts (M8 - M20)
- 2-claw pullers for pulling tightly fitted radial sealing rings, 35 mm puller range



Item #	Description
8224	Radial Seal Dismantling and Assembly Set
8224-1	Replacement Puller Legs 70 mm for BGS 8224
8224-2	Replacement Puller Legs 114 mm for BGS 8224

Separating Pliers for BMW Oil Coolers

- simplifies the assembly and disassembly of oil coolers
- screwed support bracket, 180° rotatable
- Holding forks, 15 and 22 mm
- distance adjustable (like water pump pliers)



Item #
8289

Flywheel Holding Lever

- facilitates the disassembly and assembly of clutch cover and flywheel
- hardened gear segment for locking starter gear rings



Item #
8348



Timing Chain Riveting Tool

- for renewing and riveting timing chains
- old timing chain is fed in with help of the new chain, a dismantling of the timing chain case is often not required
- suitable for Mercedes-Benz models with simplex and duplex timing chain with 4 mm chain bolt
- to be used as Mercedes-Benz OEM tools 112589096300, 602589003900, 602589023300, 602589024000, 602589056300, 602589056301

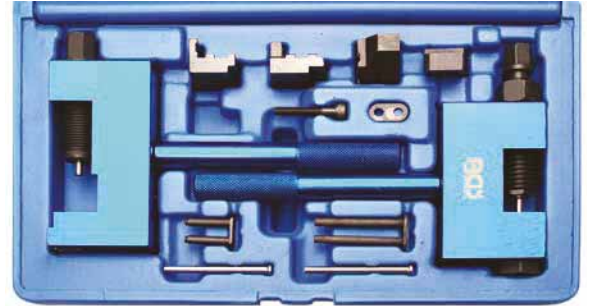

Item #	Description
8501	Timing Chain Riveting Tool
8501-1	Adaptor for BGS 8501

Supplementary Set for Timing Chain Riveting Device (BGS 8501) | suitable for 3 mm Chain Pins

- suitable for 3 mm Mercedes-Benz simplex and duplex timing chains in gasoline and diesel engines new generation
- to be used as OEM 103589016300, 602589024000 and 602589046300

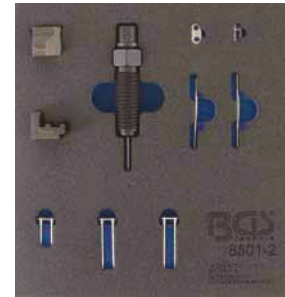

Item #	Quantity
8501-2	1/6

Belt Pulley Puller | Universal

- allows easy removal of the crankshaft pulley, provides a counterholding function to prevent rotation of the crankshaft
- counter holder with 12.5 mm (1/2") drive
- variable mounting distance 54 - 120 mm
- includes fastening screws M8 and M10



Item #
8551

Counteracting Spanner for Camshaft Sprockets | Universal

- for counterholding the camshaft sprocket while loosening and tightening the camshaft bolt
- enables a rotation of the camshaft
- adjustable and lockable opening width from 100 - 150 mm



Item #	Image
8674	

Timing Pulley Counterholder

- for loosening and fastening the camshaft wheel bolts
- suitable for all common camshaft sprockets
- adjustable from diameter 45 - 150 mm

Item #
8854



Adjustable Bearing Ring & Radial Seal Ring Driver

- for installing bearing races and radial seal rings
- adjustable to the suitable diameter
- diameter range: 18 - 86 mm
- lightweight alloy material prevents damage to bearing housing

Item #
9174



Radial Seal Ring Mounting Tool

- for mounting of shaft seal rings
- flexible rubber spider holds the radial seal ring during centering / mounting
- universally applicable for seal rings with inside diameter from 32 mm to 60 mm
- screw, washer, spider holder, handle, small and large rubber spider, 63 mm and 76 mm driver plate

Item #
9003



Crankshaft Pulley Tool Set | for Jaguar, Land Rover

- for dismantling and mounting of crankshaft pulleys
- required when working on e. g. camshaft drive
- crankshaft pulley holding tool to be used as OEM 303-893
- bridge piece
- pressure plate
- guide pin
- force screw
- and 2 securing bolts, to be used as 303-588

Item #
9007



Crankshaft Pulley Tool | for BMW N47

- allows easy and gentle dismantling of the pulley bolts
- suitable for BMW N47 engines



Item #		
9015		

Balance Shaft Puller | for Audi, VW

- allows easy removing of the balancer shaft
- suitable for following models and engines with 4 cylinders 1.8, 2.0 L injection engines with timing chain:
 - VW Golf (since 04), Passat (since 06), Passat CC (since 09), Tiguan (since 08), Eos (since 06)
 - Audi A3 (since 04), A4 (since 08), A5 (since 08), TT (since 07)
- to be used as OEM T10394
- internal thread: M8 x 1.25 mm for sliding hammer
- ideal as a complement to BGS 68345



Item #
9065

Pulley Counterholder for BMW

- allows easy loosening and tightening of torsional pulleys on BMW engines

suitable for the following models:

- E81 120D (163 PS), E46 318D (115 and 116 PS), 318TD (115 PS), E46 320D (136 and 150 PS), 320TD (150 PS), E90 318D (150 PS), 320D (150 and 163 PS), E91 318D (122 PS), 320D (150 and 163 PS), E39 520D (136 PS), E60 520D (150 and 163 PS), E61 520D (150 and 163 PS), E83 X3 2.0D (150 PS)

suitable for crankshaft pulleys with BMW part numbers:

- 11 23 7 787 304, 11 23 7 790 921, 11 23 7 793 882, 11 23 7 801 977, 11 23 7 805 696

- to be used as OEM 116310



Item #
9066

Crankshaft Seal Ring Mounting Tool | for VAG 1.2 L FSI

- allows damage-free installation of PTFE crankshaft seal ring in timing case
- suitable for Golf / Golf Plus as of 2009 & Polo as of 2010
- includes seal ring stretching sleeve & pushing sleeve
- to be used as OEM T10417/1 & T10417

Item #
9091



Ignition Coil Puller for VAG

- for removing ignition coils on VAG models as of 2013
- pencil type for inserting in mounting hole of the ignition coil
- suitable for 4 cylinder 1.2 / 1.4 / 1.8 / 2.0 FSI / TFSI engines, built in e. g. VW Golf, Audi A3, Seat Leon, Skoda Octavia
- to be used as OEM T10530

Item #
9094



Crankshaft Seal Ring Installation Tool | for VAG 2.0 TFSI

- for installing the crankshaft front seal ring
- suitable for 4 cylinder 2.0 TFSI petrol engines, built in e. g. Audi A3

Item #
9202



Balancer Shaft Locking Tool | for BMW

- for locking / adjusting the balancer shaft
- L-shape with 9 mm slot
- to be used as OEM 118700

Item #
9222



Crankshaft Vibration Dampener Alignment Tool | for Ford, Volvo

- for aligning of the crankshaft vibration dampener (crankshaft pulley)
- is required for e. g. 1.6 l EcoBoost engines
- to be used as OEM Ford 303-1550 or Volvo 9997431

Item #
9224



Timing Chain Tensioner Lever | for VAG 1.8 / 2.0 TFSi

- used to push back the timing chain tensioner without removing the front engine cover
- required when renewing the timing chain
- to be used as OEM T40243

suitable for the following TFSI engines / models (as of 2007):

- Audi A3, A3 Cabrio, TT, Q3
- Seat Alhambra, Altea Free Track, Exeo, Leon FR, Toledo
- Skoda Octavia II, Superb III (3T), Yeti
- Volkswagen Eos, Golf VII, Passat (B6), Passat CC, Passat Variant, Sharan, Beetle, Scirocco, Tiguan
- engine codes (1.8 l engines):
 - CDAA, CDHA, CDHB, CJEB, CDAB, CGYA
- engine codes (2.0 l engines):
 - CCZA, CDNB, CDNC, CFKA, CCZC, CPSA, CESA, CETA, CCZB, CDND, CCZD



Item #
9272

Radial Seal Ring Extractor Tool Set for Crank- & Camshafts

- for assembly and disassembly of rotary shaft seals
- especially suitable for sealing rings, where a stub shaft protrudes and a disassembly is almost impossible without this tool
- holds the sealing ring on the inside with a conical profile
- suitable for most commercial sealing rings
- extractor for 35 - 44 mm sealing ring diameter, with 31.5 mm center bore
- extractor for 59 - 64 mm sealing ring diameter, with 54.5 mm center bore



Item #
8759

Radial Seal Ring Extractor Tool Set for Crank- & Camshafts | for VAG | 7 pcs.

- for assembly and disassembly of rotary shaft seals
- especially suitable for sealing rings, where a stub shaft protrudes and a disassembly is almost impossible without this tool
- holds the sealing ring on the inside with a conical profile
- suitable for most commercial sealing rings
- suitable for most VAG petrol engines such as VW Lupo and Polo 1.4l, VR6, Audi V6, etc.
- includes the following pullers: 5 short pullers, Ø 25 - 32 - 35 - 27 - 55 mm
- 1 long puller, Ø 32 mm



Item #
9280

Tool Tray 1/6: High Pressure Pump Sprocket Puller | for Hyundai & Kia

- to remove the high pressure pump sprocket when dismantling the high pressure pump on Common Rail Diesel vehicles from Hyundai and Kia
- suitable for the following models:
KIA Carens (UN), Cee'd (ED) & (JD), Optima (TF), Rio (UB), Soul (AM), Sportage (SL) & (SLE), Venga (YN), Soul (PS), Hyundai Matrix, Getz, i30
- engine codes: 1.1D (TCI-U2), 1.4D (TCI-U2), 1.6D (TCI-U2), 1.7D (TCI-U2), 1.6 TCI (U2), 1.4 CRDi (U2), 1.6 CRDi (U2)
- contains: high pressure pump removal tool, to be used as OEM 093312A010, consisting of base plate, sprocket stopper, mounting screws



Item #		
9497		

High Pressure Pump Sprocket Puller for Hyundai / Kia

- for pulling off the sprocket of the high pressure pump
- needed when replacing the high pressure pump

suitable for the following models:

- Kia Sorento BL (as of 2003 - 2009), engine codes: D 2.5 VGT, D 2.5 WGT
- Hyundai iLoad (as of 2007), engine codes: D 2.5 TCI-A, D 2.5 TCI-A2
- to be used as OEM 09331-4A0000

Item #
9332



Crankshaft Pulley Holding Tool | for Honda & Acura | 50 mm

12.5  1/2

- for holding the crankshaft pulley of the damper when loosening or fastening the crankshaft pulley bolt
- required e. g. while working on toothed belt drive
- suitable for most Honda and Acura engines as in Accord, Civic, CR-V, FR-V, Legend, Jazz, Odyssey, Prelude, S2000, Shuttle, Stream 2.0i motor, Code F20A4
- to be used as OEM 07MAB-PY3010A with a 12.5 (1/2) ratchet or sliding bar
- socket, 19 mm (BGS 10559) can be used as additionally required alternative tool for OEM 07JAA-001020A



Item #		
9464		

Injector Pump Sprocket Puller / Timing Chain Tensioner Kit | for BMW, Opel

- puller for BMW injection pump sprocket
- is required for the disassembly of diesel injection pumps
- includes puller tools for the following applications:
 - for removing the sprocket from the pump shaft, suitable for 4-cyl. and 6 cyl. BMW engines M41, M51 and identical engines in Opel/Vauxhall Omega 2.5 TD (M51)
 - for removing the sprocket from the pump shaft and holding the pump wheel in the assembly position, suitable for BMW engines M47, M47TU, M57, M57TU
 - for tensioning the timing chain, suitable for BMW engines M50, M62, M62
- to be used as OEM 135120 - 135190 - 135191 - 135192 - 114230



Item #	Description
8750	Injector Pump Sprocket Puller / Timing Chain Tensioner Kit for BMW, Opel
8750-1	Injection Pump Wheel Puller for BMW, Opel

Cylinder Head Stud Tool Set | 9 pcs.

- for easy removing and installing of studs in cylinder heads without damaging the thread
- also useable for other studs
- suitable for most popular stud sizes: M6 x 1.0 - M8 x 1.25 - M10 x 1.25 - M10 x 1.5



Item #
9185

System Tray for Cylinder Head Repair

- needed when repairing cylinder heads, e. g. replacing the valves, hydraulic valve lifters, valve stem seals, etc.
- allows a safe and confusion free storing of components, such as camshafts, valves, valve springs, hydraulic tappets, shims, etc.
- length: 400 mm
- width: 450 mm
- height: 260 mm



Item #
8552

Accelerator Adjustment Tool

- allows precise adjustment through spindle
- useful while the diagnosis of engine noise, checking the engine control, such as injector return flow test, checking the charging system, etc.
- clamping screw for mounting on the brake pedal



Item #
8957

Engine Mounting Ring Spanner Set | for Mercedes-Benz | 2 pcs.

10  3/8

- ring spanner, 10 mm (3/8") drive, 12-point profile, 16 mm
- ring spanner, 10 mm (3/8") drive, 12-point profile, 17 mm
- suitable for engine mounting on Mercedes-Benz: W220, W210, W203, W221, W211, W204, W124, W140, W170, W126, W201, W202, W210
- length: 100 mm



Item #
9524



Testing Tool for Turbo Charger Systems

- for checking the charging system components when installed
- professional and economic troubleshooting
- safety valve prevents applying excessive pressure
- suitable for turbochargers, G-chargers, compressors
- fits on most charging system hoses
- also suitable for leak detection
- includes 4 pairs of adaptors

suitable for the following hose sizes:

- 35 - 40 - 45 mm
- 50 - 55 - 60 mm
- 65 - 70 - 75 mm
- 80 - 85 - 90 mm



Item #	Description
8563	Testing Tool for Turbo Charger Systems
8563-1	Replacement Safety Valve for BGS 8563

Testing Tool for Turbo Charger Systems | for Mercedes-Benz, Nissan, Renault, VW

- helps to locate leaks in the components of turbocharger systems such as pressure hoses, air-to-air intercooler, etc.
- testing must be performed when engine is switched off
- allows a professional and economical diagnosis
- includes: pressure regulator to ensures optimum test pressure and test adaptors with bayonet lock, Ø 31 - 38 - 46 - 51 - 56 - 61 mm
- use of additional leak detection sprays is possible for finding even the smallest leaks
- suitable for e. g. VW, Mercedes-Benz, Renault, Nissan



Item #
8777

Testing Tool for Turbo Charger Systems with Manometers | 55 - 60 - 65 - 70 mm

- for checking the charging system components when installed
- professional and economic troubleshooting
- suitable for turbochargers, G-chargers, compressors
- includes following adaptors:
 - 2-step pressure adaptor for hose sizes 55 - 60 mm
 - 2-step sealing cap with pressure gauge for hose sizes 55 - 60 mm
 - 2-step pressure adaptor for hose sizes 65 - 70 mm
 - 2-step sealing cap with pressure gauge for hose sizes 65 - 70 mm



Item #
8958

Special Spanner for Turbocharger, 12-point | for VW, Audi | 12 mm

- wrench for assembly and disassembly of turbo chargers
- facilitates assembly of hard-to-reach screws
- 10 mm (3/8") drive
- 12 mm, 12-point profile
- length: 99 mm
- depth: 85 mm

Item #
1004



Vacuum-Pressure Adjuster Socket for VAG Turbochargers | 10 mm

6.3 1/4

- for the exchange of the vacuum-pressure adjusters in VAG engines with turbochargers with position sensor
- to be used as OEM T10422A
- wrench size: 10 mm
- length: 50 mm

Item #
9453



Valve Spring Compressor Assembly Set | 13 pcs.

- for depressing the valve springs
- allows a changing of the valve stem seals without removing the cylinder head
- with pressure hose for filling compressed air into the cylinder
- suitable for M14 and M18 ignition plug threads
- including valve collet mounting tool
- max. width: 515 mm

Item #
1778



Universal PRO Valve Spring Tensioner

- for tensioning of valve springs
- suitable for 1 to 12 cylinder engines with 2 and 4-valve technology
- also suitable for in-line and V engines from VW, Audi, Ford, Peugeot, Volvo, etc.
- mounting on different breakpoints is possible
- universally usable by a variety of settings

contains 7 pressure pieces with varying diameter sizes for e.g. following models:

- Ø 21 mm for Peugeot, Citroen HDI
- Ø 24 mm for VW, Audi, Seat, Smart and Opel
- Ø 25 mm for Hyundai
- Ø 28 mm for Toyota, Ford 16V
- Ø 32 mm for Opel, Peugeot
- Ø 35 mm for Renault, Peugeot
- Ø 42 mm for Ford



Item #
8357

Air Valve Spring Compressor Set | 15 pcs.

10 $\frac{3}{8}$ "

- prevents the engine valve from falling into the body due to counterpressure, caused by air delivered via a spark plug-thread
- suitable for spark plug threads M14 x 1.25 and M18 x 1.5
- extensive accessories
- operates with 10 mm (3/8") drive T-handle or ratchet



Item #
1744

Valve Spring Compressor | 35 - 200 mm

- for large petrol or diesel engines
- 2 valve spring pressure pieces:
 - outside Ø 25 mm for spring Ø 21 - 25 mm
 - outside Ø 30 mm for spring Ø 24 - 30 mm
- surface finish: chrome plated



Item #
1878

Valve Spring Compressor | 72 - 130 mm

- surface finish: chrome plated

Item #
1877



Valve Spring Compressor | for OHC engines | 72 - 240 mm

- for Toyota and others

Item #
1940

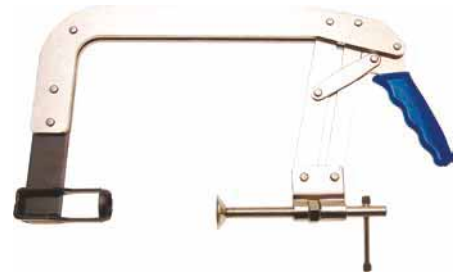

Valve Spring Compressor "OverHead"

- for uncovered valves
- suitable for valve spring cap diameters 25 - 38 mm
- max. tensioning range: 39 mm

Item #
1762



OHC Valve Spring Compressor

- with reversible legs and automatic valve shaft sealing
- not suitable for valve springs that are set deeply into the engine
- valve springs and valve shaft seals are replaced together with the cylinder head

Item #
1777



Valve Spring Compressor | for OHV Valve Springs

- length: 320 mm

Item #
1781



Special Valve Spring Compressor | 75 mm

- overhead type
- surface finish: nickel plated

Item #		
1873		



Valve Spring Tensioning Tool for Peugeot, Citroen

- very useful when working on valves
- suitable for 1.0, 1.1, 1.4, 1.6 Petrol engines
Peugeot 106, 205, 206, 306, 307, 405 and Citroen Xsara, Berlingo
- engine codes: T9M (CDY,CDZ), TU1M (HDZ,HDY), TU3M/Z (KDX,KDY, KDZ) TU3JP (KFW,KFX), TU3FJ2 (KFY,KFZ), TU5JP (NFZ)
- to be used as OEM 4533-TZ

Item #
8238



Valve Shim Remover for DOHC Engines

- suitable for all DOHC engines e. g. in Volvo, Opel, Ford, Renault etc.
- sliding t-bar for easy handling

Item #	
8252	



Valve Spring Compressor | for BMW N20, N26, N55

- for removing and installing the pressure spring on the intermediate lever
- to be used as BMW OEM 117110

Item #
62673



Precision Feeler Gauges

- stainless steel blades
- with conical blades
- 100 mm long
- 0,05-1,0 mm
- metal handle



Item #	Description
3082	Precision Feeler Gauges 13 Blades
3083	Precision Feeler Gauges 20 Blades

Special Feeler Gauge | 11 pcs.

- ideal for measuring the piston ring tolerance
- 0.03 - 0.04 - 0.05 - 0.06 - 0.07 - 0.10 - 0.15 - 0.25 - 0.30 - 0.40 - 0.50 mm

Item #
3135



Precision Feeler Gauges, bent | 12 Blades

- stainless steel blades
- 0.08" - 0.10" - 0.12" - 0.13" - 0.14" - 0.15" - 0.16" - 0.18" - 0.19" - 0.20" - 0.25" - 0.26"
- 0.203 - 0.254 - 0.305 - 0.330 - 0.356 - 0.381 - 0.406 - 0.457 - 0.483 - 0.508 - 0.635 - 0.660 mm

Item #
3184

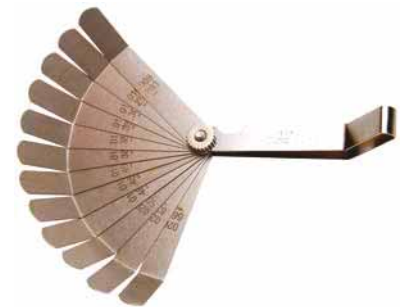

Valve Wedge Removing Tool

- suitable for cars, scooters, lawnmowers with valve stem diameter up to 5.5 mm
- quick and easy disassembly of the valve wedges
- minimizes repair costs

Item #
8444



Valve Stem Seal Pliers | 250 mm

- for multi-valve engines
- for easy removing of deep valve stem seals on multi valve engines
- e. g. for VW, Opel, Ford

Item #
1780



Valve Stem Seal Pliers | 270 mm

- for easy removing of deep valve stem seals on multi valve engines
- extra long jaws, especially for multi-valve engines, e. g. Opel, VW and Ford
- hardened jaws

Item #
8668



Valve Shims Pliers | 275 mm

- for removing valve adjusting shims
- suitable for OHC engines on Audi, Porsche, Ford, Fiat, VW, etc.

Item #
8830



Sliding Hammer Extractor for Valve Stem Seal Ring

- suitable for PSA engines
- for fast, accurate and professional extraction of stuck valve stem seals without causing damage to the surrounding areas
- suitable for internal diameters of 6 to 9.5 mm
- sliding hammer thread M16 x 2.0

Item #
62610



Valve Seat Cutter Set | 30 - 60 mm | 27 pcs.

- not suitable for hardened valve seats
- in metal case
- milling at 45° and 90°: 30 - 32.5 - 35 - 37.5 - 40 - 42.5 - 45 - 47.5 - 50 - 52.5 - 55 - 57.5 - 60 mm
- 13 stem guides: 6 - 6.5 - 7 - 7.5 - 8 - 8.5 - 9 - 9.5 - 10 - 10.5 - 11 - 11.5 - 12

Item #
1970

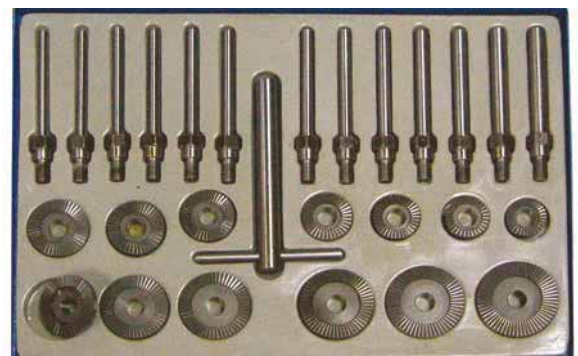

Valve Seat Milling Cutter Set | 14 pcs.

- suitable for cylinder heads with hardened valve seats
- 6 double ended cutters:
 - Ø 28 - 35 mm, 45° and 75°
 - Ø 37 - 44 mm, 30° and 75°
 - Ø 37 - 46 mm, 45° and 68°
 - Ø 44 - 52 mm, 30° and 75°
 - Ø 46 - 60 mm, 30° and 45°
 - Ø 52 - 65 mm, 60° and 75°
- 4 continuously adjustable guides for Ø 6.5 to 12.5 mm
- T-handle for milling cutters



Item #
68346

Valve Lapping Tool Attachment

- facilitates the insertion of valves
- automatic change in direction
- for use with fine grinding paste
- with 8 mm shank for holding in drill machine
- working speed min. 1000 rpm to max. 1250 rpm
- 4 different suction plates in 20, 30, 35 and 40 mm
- 13 mm shaft for attaching the suction cups



Item #	Description
1738	Valve Lapping Tool Attachment
1738-1	Rubber Adaptor for BGS 1738 Ø 17.3 mm
1738-2	Rubber Adaptor for BGS 1738 Ø 22 mm

Suction Valve Grinder

- wooden handle, 2 rubber suction cups



Item #	Description
1740	Suction Valve Grinder 16 x 21 mm
1741	Suction Valve Grinder 28 x 34 mm

Tensioner Pulley Wrench Set | 12-point 13 - 19 mm | 5 pcs.

- 45° offset heads allow you to reach all areas in the engine bay
- with slip guard handle for easy handling
- tensioner pulley wrenches 12-point 13 - 15 - 16 - 17 - 19 mm
- length: 460 mm



Item #	Description
1310	Tensioner Pulley Wrench Set 12-point 13 - 19 mm 5 pcs.
1310-14	Tensioner Pulley Wrench 12-point 14 mm

Tensioner Pulley Wrench Set | 12-point, special Shape | 13 - 19 mm | 5 pcs.

- double angled for better reach of confined areas
- with slip guard handle for easy handling
- tensioner pulley wrenches 12-point 13 - 15 - 16 - 17 - 19 mm
- length: 460 mm
- surface finish: chrome plated

Item #
1314

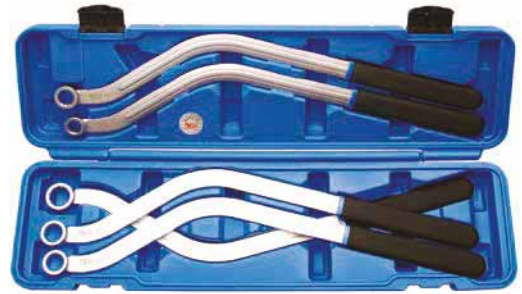

Tensioner Pulley Wrench Set | E-Type E10 - E18 | 5 pcs.

- E10 - E12 - E14 - E16 - E18, length 460 mm
- 45° offset heads allow you to reach all areas in the engine bay
- space-saving, flat design
- ideal for screws of belt and tensioning pulley
- with slip guard handle for easy handling

Item #
1311

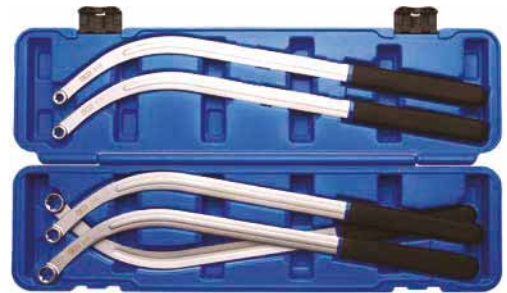

Tensioner Pulley Wrench Set | 12-point 12 - 19 mm / E-Type E10 - E18 | 15 pcs.

- 12-point heads in the following sizes: 12, 13, 14, 15, 16, 17, 18 and 19 mm
- E-type heads in the following sizes: E10, E12, E14, E16, E18
- long wrench for easy handling
- quick connector 13.8 x 8.1 mm
- with slip guard handle for easy handling

Item #
1312



Serpentine Belt Servicing Tool Kit | 10 mm (3/8") + 12.5 mm (1/2")

- combines the advantages of a ratcheting wrench with the requirements of the serpentine belt removal tool to provide best possible combination
- provides coverage for all major vehicles with serpentine belts
- metric sockets 8 - 12 - 13 - 14 - 17 - 18 - 24 mm
- inch sockets 10 mm (3/8") - 12,5 mm (1/2") - 5/8"

Item #
1706



Belt Pully Wrench for V-Belt Pulleys

- for assembly of pulleys (counterholder)
- universally applicable
- 850 mm long strap

Item #
1024



Belt Pulley Wrench for Ribbed and Flat Drive Belts

- for holding back ribbed drive belt pulleys (for example when loosening belt pulley bolts)



Item #
1026



Belt Gauge

- for adjusting initial tension of the drive belt
- can be used for all types of cars as far as information on recommended tension are available
- 1 rotation of the adjusting nut changes the piston load approx. 10 N
- tension can be read on front and back side of the tool



Item #
1705



Tensioner Pulley Wrench for V-ribbed Belts | 450 mm

- for loosening the automatic tensioner when changing the poly-V-belt
- for VW Golf, Passat, Polo, T4



Item #
1707

Counterholding Wrench Set with adjustable Pins

- adjustable from 40 to 220 mm
- through the overall length of approx. 400 mm and the associated torque, ideal e. g. for loosening the fastening screw on injection pumps
- for locking the camshaft or diesel pump
- for belt and chain drives
- for tensioning and discharging of locking pins
- incl. 4 pairs of holding pins \varnothing 6 - 10 mm, 8 - 11 mm, 10 - 12 mm, 11 - 16 mm to be used with nearly all camshaft sprockets
- length: 400 mm



Item #
1714

V-Ribbed Belt Tool Set | 2 pcs.

- facilitates assembly and disassembly of Poly-V-Belts
- suitable for most belt pulley sizes
- easy handling through wing nut

Item #
8220



V-Ribbed Belt and elastic Belt Assembly Tool Set | 11 pcs.

- suitable for assembly and disassembly of elastic V-ribbed belts and double belt pulleys
- for easy and professional belt replacement
- prevents damage to the belt pulley and the belt with minimal effort

- 1 engine rotation adapter, double-sided
- 1 adapter for water pump suitable for Volvo and Ford
- 1 adapter for crankshaft pulleys
- 2 straps attachment with 3 receptacles
- 1 strap attachment with 1 receptacle
- 3 spacers, length: 25, 40 and 65 mm
- 1 belt expansion tool
- 1 cover

suitable for following models:

- BMW 118, 120, 318, 320, 325, 330, 335, 520, 525, 530, 535, 635, 720, X3, X5
- Audi A3 1.6/2.0D
- Seat Altea, Ibiza 1.6/2.0D
- Skoda Octavia, Yeti 1.6/2.0D
- Volkswagen Eos, Golf, Passat, Polo, Scirocco 2.0D
- Chrysler Grand Voyager, Voyager 2.5D/2.8D
- Ford C-Max, Focus, C-Max, Mondeo, Tourneo, Transit 1.4/1.6/1.8/2.0
Transit, Transit Tourneo 2.2D, Courier, Fiesta, Fusion 1.6, Mazda 3, 5, Axela 1.8/2.0 and 2 1.2/1.4/1.6 model
- Mercedes Sprinter, Viano, Vito 3.0D
- Peugeot 206, 207, 307, Boxer 1.6D/2.2D/3.0D
- Citroen C2, C3, C4, Jumper, Relay 1.6D/2.2D/3.0D
- Fiat Albea, Doblo, Ducato, Fiorino, Fiorino Qubo, Linea, Palio, Siena, Stilo, Strada Pickup 2.2D/2.3D/3.0D, Doblo, Marea, Multipla 1.6l, Iveco Daily 2.3D / 3.0D
- Volvo C30, S40, V50 1.6/1.8/2.0
- Lancia Lybra 1.6
- Mitsubishi ASX 1.8D

Item #
8301-1



V-Ribbed Belt and elastic Belt Assembly Tool Set | 7 pcs.

- suitable for assembly and disassembly of elastic / flexible V-ribbed belts and double belt pulleys
- for easy and professional belt replacement
- prevents damage to the belt pulley and the belt with minimal effort
- includes 3 different special tools

- 1 strap attachment with 3 receptacles
- 1 strap attachment with 1 receptacle
- 1 adapter for water pump suitable for Volvo and Ford
- 1 adapter for crankshaft pulleys
- 3 spacers, length: 25, 40 und 65 mm

suitable for the following models:

- BMW 118, 120, 318, 325, 330, 335, 520, 525, 530, 535, 635, 730, X3, X5 with fuel and diesel engines
- Chrysler Grand Voyager, Voyager
- Citroen C2, C3, C4, Jumper, Relay
- Fiat Albea, Doblo, Marea, Multipla, Ducato, Fiorino, Fiorino Qubo, Linea, Palio, Siena, Stilo, Strada Pick Up
- Lancia Lybra
- Ford C-Max, Focus, Mondeo, Tourneo, Transit, Courier, Fiesta, Fusion
- Iveco Daily
- Mazda 3, 5, Axela
- Peugeot 206, 207, 307, Boxer
- VOLVO C30, S40, V50



Item #
8301

V-Ribbed Belt Mounting Lever | for Mercedes-Benz

- for tensioning of the tensioning wheel
- facilitates the placement of the V-ribbed belt
- suitable for Mercedes-Benz types: 168, 169 (A-class), 245 (B-class)
- wrench size: 15 mm
- length: 620 mm



Item #
1703

Mounting Tool Kit for Stretch-Fit Poly-V-Belts | universal

- allows a damage-free mounting of stretch-fit belt systems without tensioner
- 2 different sizes for a wide range of application



Item #
8454



Flexible Belt Mounting Tool for Citroen, Fiat, Ford, Mitsubishi, Peugeot

- allows damage-free mounting of flexible multi-ribbed belts
- flexible belt drive requires no idler, but this particular assembly tool

suitable for the following models:

- Citroen Jumper, Relay 2.2D, engine code: 22DT
- Fiat Ducato 2.2D, engine code: 4HF
- Ford Transit, Transit Tourneo, 2.2D, engine codes: C22DDOP, PGFA, P8FA, QVFA, QWFA
- Mitsubishi ASX 1.8D, engine code: 4NI
- Peugeot Boxer 2.2D, engine code: 22DT



Item #
9157

Flexible Belt Mounting Tool for BMW N52K

- for damage-free installing of stretch belts
- suitable for N52 engines (as of 2006)
- built in e. g. BMW X5 3.0
- to be used as OEM 111240



Item #
9277

Ribbed Belt Tool Kit | for MINI

- suitable for MINI Cooper S and One
- for tensioning of air conditioning and alternator ribbed belts
- release lever, for Cooper S, to be used as OEM 118410
- locking pin, for Cooper S, to be used as OEM 118470
- release lever, for MINI One, to be used as OEM 118390
- locking pin, for MINI One, to be used as OEM 118280

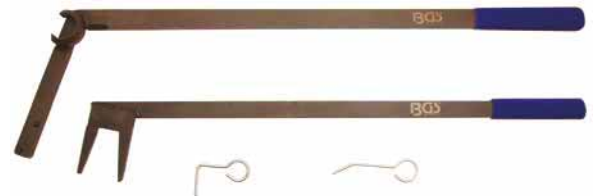

Item #
8678

Air Condition Belt Installation Tool for BMW N62 / MINI W17

- for installation of stretch belts (drive belts without tensioner)
- suitable for stretching belts on BMW N62 (V8) (2004-2006) and MINI W17 (Diesel)
- to be used as OEM 641040



Item #
9038



Drive Belt Gauge

- for measurement of the inside length of drive belts like V-belts, timing belts and ribbed belts
- measuring range: 500 - 2500 mm



Item #
8863

Spark Plug Wrench with T-Handle, Ball Joint

- PVC coated T-type handle



Item #	Description
143	Spark Plug Wrench with T-Handle, Ball Joint 16 mm
144	Spark Plug Wrench with T-Handle, Ball Joint 20.8 mm

Ball Joint Spark Plug Wrench with Torque Limit | 20 Nm | 16 mm

- due to the torque limit spark plugs cannot be damaged
- wrench size: 16 mm
- profile: 12-point
- length: 550 mm
- surface finish: satin chrome plated
- torque: 20 Nm



Item #
146

Spark Plug Socket with Magnet, 12-point, long | 10 mm (3/8") Drive | 14 mm

10 3/8

- spark plug is held by a magnet
- with extra big knurl for better grip
- wrench size: 14 mm
- profile: 12-point, 10 mm (3/8") drive
- length: 90 mm
- surface finish: satin chrome plated
- outside diameter: 18.5 mm



Item #
2446



Spark Plug Sockets with Retaining Spring, 12-point | 10 mm (3/8") Drive

10  3/8

- with retaining spring
- for extra long spark plugs (e. g. for BMW)
- length: 100 mm
- surface finish: satin chrome plated



Item #	Description
2390	Spark Plug Socket, 12-point, with Retaining Spring 10 mm (3/8") Drive 14 mm
2391	Spark Plug Socket, 12-point, with Retaining Spring 10 mm (3/8") Drive 16 mm
2392	Spark Plug Socket, 12-point, with Retaining Spring 10 mm (3/8") Drive 21 mm



Spark Plug Socket, 12-point | 10 mm (3/8") Drive | 14 mm

10  3/8

- wrench size: 14 mm
- profile: 12-point
- surface finish: satin chrome plated



Spark Plug Socket, 12-point, extra long | 10 mm (3/8") Drive | 14 mm

10  3/8

- 12-point
- with retaining spring
- for extra long spark plugs (e. g. for BMW)
- length: 180 mm
- surface finish: satin chrome plated



Spark Plug Sockets, 12-point, extra long | 10 mm (3/8") Drive

10  3/8

- with retainer spring for spark plugs
- knurled
- length: 250 mm
- surface finish: chrome plated



Item #	Description
2404	Spark Plug Socket, 12-point, extra long 10 mm (3/8") Drive 14 mm
2405	Spark Plug Socket, 12-point, extra long 10 mm (3/8") Drive 16 mm
2449	Spark Plug Socket, 12-point, extra long 10 mm (3/8") Drive 18 mm



Spark Plug Socket with Magnet, extra long | 10 mm (3/8") Drive | 14 mm

10  3/8

- spark plug is held by a magnet
- with extra big knurl for better grip
- wrench size: 14 mm
- profile: 12-point
- length: 250 mm
- surface finish: satin chrome plated
- outside diameter: 18.5 mm

Item #
2447



Spark Plug Socket, Hexagon | 12.5 mm (1/2") Drive | 14 mm

- wrench size: 14 mm
- profile: 12-point
- length: 65 mm
- surface finish: black burnished
- outside diameter: 20 mm

Item #
2400



Spark Plug Sockets, Hexagon

- forged
- profile: hexagon
- surface finish: chrome plated



Item #	Description
2466	Spark Plug Socket, Hexagon 10 mm (3/8") Drive 16 mm
2464	Spark Plug Socket, Hexagon 10 mm (3/8") Drive 18 mm
2461	Spark Plug Socket, Hexagon 12.5 mm (1/2") Drive 20.8 mm



Spark Plug Sockets, Hexagon

- forged
- rubber inlay
- surface finish: chrome plated, polished



Item #	Description
2471	Spark Plug Socket, Hexagon 10 mm (3/8") Drive 16 mm
2472	Spark Plug Socket, Hexagon 12.5 mm (1/2") Drive 16 mm
2470	Spark Plug Socket, Hexagon 12.5 mm (1/2") Drive 21 mm



Spark Plug Sockets with Magnet, Hexagon

- forged
- surface finish: chrome plated
- magnetic inlay



Item #	Description
2469	Spark Plug Socket with Magnet, Hexagon 10 mm (3/8") Drive 16 mm
2468	Spark Plug Socket with Magnet, Hexagon 12.5 mm (1/2") Drive 16 mm
2463	Spark Plug Socket with Magnet, Hexagon 12.5 mm (1/2") Drive 21 mm



Spark Plug Sockets with Rubber Mount, 12-point

- 12-point
- surface finish: satin chrome plated



Item #	Description
2385	Spark Plug Socket with Rubber mount, 12-point 12.5 mm (1/2") Drive 16 mm
2387	Spark Plug Socket with Rubber mount, 12-point 10 mm (3/8") Drive 18 mm
2386	Spark Plug Socket with Rubber mount, 12-point 12.5 mm (1/2") Drive 21 mm



Spark Plug Sockets, Hexagon | 12,5 mm (1/2")

12.5 mm 1/2"

- surface finish: chrome plated
- retainer spring for spark plugs
- 12,5 mm (1/2") drive
- length: 65 mm



Item #	Description
2401	Spark Plug Socket, Hexagon 12.5 mm (1/2") Drive 16 mm
2402	Spark Plug Socket, Hexagon 12.5 mm (1/2") Drive 18 mm
2403	Spark Plug Socket, Hexagon 12.5 mm (1/2") Drive 21 mm



Spark Plug Socket with Rubber mount, 12-point, long | 10 mm (3/8") | 16 mm

10 mm 3/8"

- wrench size: 16 mm
- profile: 12-point
- length: 90 mm
- surface finish: satin chrome plated

Item #	CV
2448	



Spark Plug Socket | 3-step extendable | 10 mm (3/8") Drive | 20.8mm

10  3/8

- knurled
- 3-step adjustable
- socket size: 20.8 mm (13/16") hexagon
- with holding rubber
- surface finish: satin chrome plated
- length 137.5 - 157.5 - 197.5 mm



Item #
9154



Spark Plug Pipe Wrench | for Toyota Prius | 16 x 20.6 mm

- pipe wrench with side hole for installation/removal of spark plugs
- sizes: 5/8" x 13/16" (16 x 20.6 mm)
- incl. rotary bar
- length: 300 mm
- surface finish: satin chrome plated



Item #
8772

Spark Plug Connector Pliers | with Ring Tip Ø 13 mm | 330 mm

- long version especially for engines with deep seating of the spark plugs
- universal usage
- suitable for heat protection connectors
- even with the double joint mechanism the pliers require less space to open and grab
- 45° angled gripper sleeves
- secure handling because of milled inner profile
- very long plier arms
- for wide safety distance to the hot engine unit
- for damage-free removal and installation of spark plug connectors, even when the engine is warm
- handle type: PVC dipped



Item #
8662



Spark Plug Connector Pliers | with Ring Tip Ø 16 mm | 200 mm

- ring tip with 16 mm internal diameter
- length: 200 mm
- surface finish: nickel plated, matt
- handle type: 2-component handles



Item #
1737



Spark Plug Connector Pliers | 30° offset

- for deep seated spark plugs
- handle type: 2 component handles
- surface finish: nickel plated, matt



Item #	Description
1784	Spark Plug Pliers 200 mm 30° offset
1739	Spark Plug Pliers 290 mm 30° offset



Spark Plug Socket Puller Set | 225 + 350 mm | 2 pcs.

- especially for metal coated spark plug sockets on VW engines
- prevents spark plug wires from damage during assembly

Item #
65260



Ignition Coil Extractor for VAG | 4 pcs.

- for fast and safe assembly and removal of ignition coils with power output stage
- prevents damage to the coil and on the housing
- covers most VAG models
- surface finish: satin chrome plated

scope of delivery:

- ignition pullers with T-handle, to be used as OEM T10095 A
 - suitable for: 6 cylinder & 5 cylinder injection engines, for following vehicles: VW Golf (> 1998), Passat (> 1997), Sharan (> 1996), Touareg (> 2003), Bora (> 1999), Eos 3.2L (> 2006), T5 3.2L (> 2004), Phaeton (> 2003), Audi A3 3.2L (> 2004), Audi TT 3.2L (1999-2007)
- ignition puller with T-handle, to be used as OEM T10166
 - suitable for: 8 cylinder & 12 cylinder injection engines, for following vehicles: VW Passat (> 1997), Phaeton (> 2003)
- ignition puller with T-handle, to be used as OEM T10094 A
 - suitable for: VW 1.2, 1.4, 1.6 l engines, for following vehicles: Fox, Lupo, Polo, Golf (Golf Plus > 2005), Beetle, Scirocco, Passat, Touran, T4, Skoda Fabia
- ignition puller with finger pull ring, to be used as OEM T40039
 - suitable for: 1.8, 2.0, 3.2, 3.6, 4.2, 5.2 l engines,
 - for following vehicles: VW Polo, Golf, Passat, Scirocco, Eos, Phaeton, Touran, Tiguan und Audi A3, A4, A5, A6, A8, TT, Q5, Q7



Item #
68340

Ignition Coil Extractor for VAG

- for dismantling of ignition coils, which are mounted directly on the spark plug
- suitable for e.g. following models as of year 2013: VW Golf - Audi A3 - Seat Leon - Škoda Octavia with FSI 1.2, 1.4, 2.0 engines with timing chain



Item #
9073

Ignition Module Puller Set | for Opel | 2 pcs.

- for the easy and gentle removal of Opel ignition coils
- suitable for Opel 3- and 4- cylinder 1.0-1.2-1.4-1.6-1.8-2.0-2.2 l petrol direct engines
- installed in e. g. Agila-A, Astra-F, Astra-G, Astra-H, Astra-J, Calibra, Combo, Corsa-B, Corsa-C, Corsa-D, Frontera-A, Frontera-B, Insignia, Meriva-A, Meriva-B, Omega-B, Signum, Tigra-A, Tigra-B, Vectra-B, Vectra-C, Zafira-A, Zafira-B
- engine codes: LDD, LDE, LLU, LUH, LUJ, 2HO, A10XEP, A14NEL, A14NET, A14XER, X14NZ, X14SZ, X14XE, A16LET, A16XER, X16SZR, X16XE, X16XEL, A18XER, X18XE, X20SE, X20XEV, X22SE, X22XE, Y22SE, Z10XEP, Z12XE, Z12XEP, Z14XE, Z14XEL, Z14XEP, Z16LEL, Z16LER, Z16LET, Z16XE, Z16XER, Z16YNG, Z18XE, Z18XER, 20LEH, Z20LER, C22SEL



Item #
9421



Ignition Module Puller | for VAG

- for the easy and gentle removal of VAG ignition coils
- suitable for VAG engines 1.0-1.2-1.4 TSI / TFSI -2.0 GTI built in:
 - VW Up -2011, Polo -2012, Golf -2013, Beetle -2014, Caddy -2015, Passat -2014, Tiguan -2015, Touran -2015, Sharan -2015
 - Audi A1 -2012, A3 -2013
 - Seat Mii -2011, Ibiza -2013, Leon -2013
 - Skoda Citigo -2011, Fabia -2014, Octavia -2013
- engine codes: CJZB, CJZA, CBZB, CJZD, CYVB, CTHD, CTHA, CZCA, CZDB, CZDA, CMBA, CPVA, CPCB, CHPACPTATA, CAXA, CAVA, CAPB, CAVD, CXSA, CDGA, CXEA, CTHD, CXSB, CMBA, CKMA, CAVE, CHHB, CHHA, CCZB, CPGA, CHZB, CHYB, CHYA, CHZB



Item #
9455



Spark Plug Cleaning Brush | 140 mm

- brass wire
- length: 140 mm

Item #
3080



Repair Kit for Spark Plug Threads | M14 x 1.25 mm | 16 pcs.

- 1 tap for M14 threads, HSS-G, 16 mm drive
- 5 taps inserts 11 mm, black finished
- 5 taps inserts 16 mm, black finished
- 5 taps inserts 19 mm, yellow, zinc plated

Item #	Description
149	Repair Kit for Spark Plug Threads M14 x 1.25 mm 16 pcs.
149-1	Tap M14 x 1,25 for BGS149
149-11	Threaded Sleeves 11 mm M14 x 1.25 5 pcs.
149-16	Threaded Sleeves 16 mm M14 x 1.25 5 pcs.
149-19	Threaded Sleeves 19 mm M14 x 1.25 5 pcs.



Repair Kits for Spark Plug Threads

- suitable for repair of spark plug threads
- contains special HSS taps with external hexagon drive and 4 threaded sleeves, lengths 9.5 - 11.5 - 12.7 and 19 mm



Item #	Description
167	Repair Kit for Spark Plug Threads M8 x 1.0 5 pcs.
167-1	Thread Inserts M8 x 1.0 for BGS 167 4 pcs.
165	Repair Kit for Spark Plug Threads M10 x 1.00 mm 5 pcs.
165-1	Thread Inserts M10 x 1.00 for BGS 165 4 pcs.
166	Repair Kit for Spark Plug Threads M12 x 1.25 mm 5 pcs.
166-1	Thread Inserts M12 x 1.25 for Item 166 4 pcs.
150	Repair Kit for Spark Plug Threads M14 x 1.25 mm 5 pcs.
150-1	Thread Inserts M14 x 1.25 for BGS 150 4 pcs.



Repair Kit for Spark Plug Threads | M14 x 1.25 mm | 5 pcs.

- for repairing defective M14 spark plug threads
- HSS thread cutter - 17 mm drive
- threaded insert lengths: 9.7 - 11.0 - 13.0 - 19.1 mm
- collar thickness: 1.0 mm
- collar diameter: 17.9 mm
- material: forged carbon steel
- surface finish: black burnished

Item #
152



Internal Spark Plug Rethreader

- for cleaning and regrooving of spark plug threads in the cylinder head
- length: 270 mm, also suitable for cylinder heads with deep-seated spark plugs
- 13 mm 6-pt. drive



Item #	Description
8375	Internal Spark Plug Rethreader M12 x 1.25 mm
8376	Internal Spark Plug Rethreader M14 x 1.25 mm

Glow Plug Socket Set | 18 pcs.

6.3 1/4 10 3/8

- for disassembly and assembly of common type glow plugs and special PSG glow plugs with pressure sensor, OE number GM 55564163 / 55577419, Opel 1826354 / 1214061, VAG 03L905061D
- includes 5 protecting caps, for protecting the connector against pollution and electrostatic charging
- glow plug sockets with universal joint, length 72 mm, 10 mm (3/8") drive: 8 - 9 - 10 mm
- glow plug sockets with universal joint, length 60 mm, 6.3 mm (1/4") drive: 8 - 9 - 10 mm
- slotted glow plug sockets, sizes: 8 - 9 - 10 mm
- socket, fitting depth 8 mm, 50 mm
- glow plug socket with snap ring for PSG, , 12 mm
- extension bar 100 mm, 6.3 mm (1/4") drive
- universal joint, 6.33 mm (1/4") drive



Item #	
9026	

Universal Joint Glow Plug Set, Hexagon | 10 mm (3/8") Drive | 8 - 16 mm | 6 pcs.

- screwed universal joint
- with retaining ball to hold the glow plugs
- fitting depth: 13 mm
- universal glow plug wrenches, 10 mm (3/8") drive, hexagon 8 - 9 - 10 - 12 - 14 - 16 mm
- length: 158 mm



Item #	
2986	

Universal Joint Glow Plug Set, Hexagon | 10 mm (3/8") Drive

- 10 mm (3/8") drive, sizes 8 - 9 - 10 - 12 - 14 - 16 mm
- glow plugs are held by internal rubber ring
- with screwed universal joint, adjustable
- total length 75 mm / 80 mm (14 + 16 mm)



Item #	Description
2990	Universal Joint Glow Plug Set, Hexagon 10 mm (3/8") Drive 8-16 mm 6 pcs.
2980	Glow Plug Joint Socket, Hexagon 10 mm (3/8") Drive 8 mm
2981	Glow Plug Joint Socket, Hexagon 10 mm (3/8") Drive 9 mm
2982	Glow Plug Joint Socket, Hexagon 10 mm (3/8") Drive 10 mm
2983	Glow Plug Joint Socket, Hexagon 10 mm (3/8") Drive 12 mm
2984	Glow Plug Joint Socket, Hexagon 10 mm (3/8") Drive 14 mm
2985	Glow Plug Joint Socket, Hexagon 10 mm (3/8") Drive 16 mm



Glow Plug Socket Set | especially for Fiat, Alfa, Lancia

- for removal of glow plugs with fixed connector cable, built into latest Fiat, Alfa and Lancia models
- slotted sockets, external hexagon drive, 8 - 9 - 10 mm

Item #
7191



Torque Limited Glow Plug Sockets | 8 / 10 / 12 mm

10 3/8

- length 120 mm
- 8 mm torque limited to 15 Nm
- 10 mm torque limited to 18 Nm
- 12 mm torque limited to 18 Nm

Item #
7195



Glow Plug Socket for PSG | 12 mm

6.3 mm 1/4"

- allows damage-free disassembly / assembly of PSG glow plugs with pressure sensor
- with 5 protecting caps, to protect the connector against pollution and electrostatic charging
- suitable for VAG and Opel, e. g. PSG glow plugs with OE number GM 55564163 / 55577419, Opel 18 26 354 / 12 14 061, VAG 03L905 061 D
- 6.3 mm (1/4") drive



Item #	CV 
8961	

Double offset Ratchet Wrench for Glow Plugs | 8 x 12 mm

- for installing and removing glow plugs
- suitable for VW, Audi, Renault diesel engines
- for glow plugs between engine and diesel injector pump
- 12-point drive
- 8 mm side for electrical connection
- 12 mm for glow plugs
- length: 300 mm



Item #
8264

Twist Off Sockets for Glow Plug Electrodes | 6.3 mm (1/4") Drive

6.3 mm 1/4"

- for gripping the electrodes together with glow plug removal and thread repair set BGS 8297
- includes twist sockets 2.6 - 3.2 - 3.5 - 4.5 - 6.5 - 8.25 mm



Item #	Description
5290	Twist Off Socket for Glow Plug Electrodes 6.3 mm (1/4") Drive 6 pcs.
5290-2.6	Twist Off Socket for Glow Plug Electrode 6.3 mm (1/4") Drive 2.6 mm
5290-3.2	Twist Off Socket for Glow Plug Electrode 6.3 mm (1/4") Drive 3.2 mm
5290-4.5	Twist Off Socket for Glow Plug Electrode 6.3 mm (1/4") Drive 4.5 mm
5290-6.5	Twist Off Socket for Glow Plug Electrode 6.3 mm (1/4") Drive 6.5 mm
5290-8.25	Twist Off Socket for Glow Plug Electrode 6.3 mm (1/4") Drive 8.25 mm



Glow Plug Removal Tool

- for unscrewing and disassembly of glow plugs in the cylinder head, especially for glow plugs that are stuck because of carbonization remains
- cylinder does not need to be removed any more
- fits all Mercedes-Benz 10 mm glow plugs, engine codes 611-612-613 etc., especially CDI engines

Item #	
65601	



Glow Plug Socket Pliers

- for assembling and disassembling of glow plugs



Item #	Description
66155	Glow Plug Socket Pliers straight
66157	Glow Plug Socket Pliers 90° bent



Glow Plug Removal Tool Set | M10 x 1.0

- ensures the correct removal of burned-in, corroded or broken-off glow plugs
- allows repairing of the glow plug retaining thread without removing the cylinder head
- defective original thread M10 x 1 is repaired by insertion of a new threaded sleeve
- suitable for Mercedes-Benz CDI-engines OM 611, 612, 613, 628, 646 (not EVO), 647, 648
- puller and sliding hammer for removing of stuck and broken glow plugs
- reamers for reaming of the defective thread
- tap M10 x 1 and M12 x 1
- centering sleeve for reamers and taps
- special step drills and taps for removal of broken glow plugs
- 12 thread repair sleeves M12 x 1 to M10 x 1
- compressed air adaptor

Item #
8699

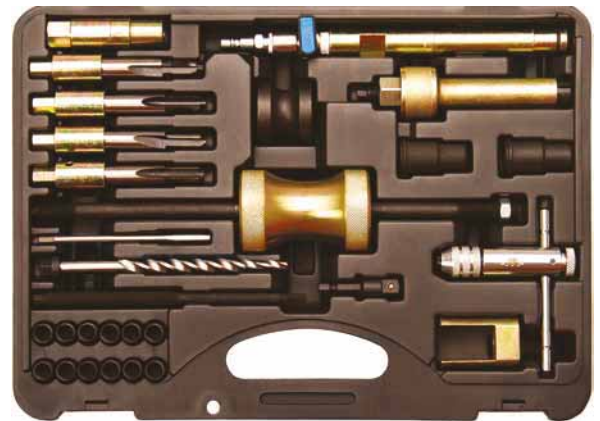

Repair Kit for Glow Plug Threads | for Audi, VW | 28 pcs.

- for quick and professional drilling out damaged or torn-off glow plugs without removing the cylinder head
- allows re-cutting or repairing of the glow plug thread and cleaning of the electrode bore
- exact depth and drilling angle are reached using guide sleeves
- suitable for M10 x 1 glow plug thread bores, e. g. on VW Passat, Audi with TDI engines 2.5, 2.7, 3.0 V6 with engine codes AFB, AKE, AKN, ASB, AYM, BAU, BCZ, BDG, BDH, BFC, BKN, BKS, BMK, BNG, BSG, BUN, BUG
- cover plate for intake ports
- compressed air adaptor for injector bore
- 9.1 mm drill for M10 x 1
- 11.1 mm drill for M12 x 1
- tap with guide sleeve for M10 x 1 threads
- tap with guide sleeve for M12 x 1 threads
- 10 threaded inserts for M10 x 1 with external thread M12 x 1
- taps M6 x 1.25 mm
- extraction tool
- 2 reamers 4.8 mm, long and short type
- reamer 5.8 mm long type
- guide sleeves, Ø 17.5 mm OD - 38 mm length, inside Ø 9 mm
- guide sleeves, Ø 17.5 mm OD - 38 mm length, inside Ø 13 mm
- guide sleeves, Ø 17.5 mm OD - 63 mm length, inside Ø 13 mm
- 2.4 - 5.5 mm tapping holder 240 mm long with 6.3 mm (1/4") drive
- 3 extractor electrodes for 2.5 - 3.5 - 4 mm



Item #
8722

Repair Set for Glow Plug Threads | 33 pcs.

- for repairing the glow plug threads in the cylinder head
- suitable for glow plug threads in sizes: M8 x 1.0 mm - M10 x 1.0 mm - M10 x 1.25 mm - M12 x 1.25 mm
- 6 taps for trimming the original thread or cutting the thread for the new thread sleeves: M8 x 1.0 mm - M10 x 1.0 mm - M10 x 1.25 mm - M12 x 1.0 mm - M12 x 1.25 mm - M14 x 1.25 mm
- 20 thread repair coils, 5 pieces each: M8 x 1.0 mm - M10 x 1.0 mm - M10 x 1.25 mm - M12 x 1.25 mm
- 2 coil drivers
- 3 centering pieces
- 1 guide pin

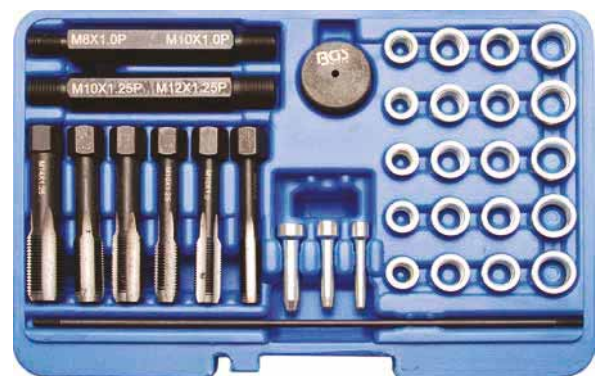

Item #
65631

Glow Plug Repair Tool Kit | 3 pcs.

- for removal of pollution from the glow plug channel and for extraction of stuck glow plugs
- perfect for Mercedes-Benz CDI engines
- tapered reamer M10 x 1.00 (4, 5 and 6 cylinder engines OM 611, 612, 613 and Smart CDI R660)
- reamer M12 x 1.25 (4-valve engines OM 604, 605, 606)
- glow plug extractor for glow plug threads 10 (OM 611, 612, 613)

Item #
65630



Glow Plug Removal Tool Kit | M9 | 9 pcs.

- allows removing of defective and broken M9 x 1.0 glow plugs
- suitable for e.g. Fiat engines
- special step drill with depth stop
- tap M9 x 1.0
- tap 1/4" x 20 UNC
- twist sockets 2.6 - 4.5 - 8.25 mm
- tool holder for taps
- pull-out unit with hardened spindle

Item #
8657



Glow Plug Bore Reamer Set | 4 pcs.

- for cleaning / removing the glow plug bore
 - cleaning is recommended before inserting the new glow plug
 - suitable for a variety of engines from Audi, Alfa Romeo, BMW, Fiat, Nissan, Opel, Peugeot, Renault, Toyota, etc.
 - contains 4 reamers in following sizes:
 - M10 x 1.00, length 107 mm
 - M10 x 1.25, length 137 mm
 - M12 x 1.25, length 59 mm
 - M12 x 1.25, length 94 mm
- material: chrome molybdenum, titanium coated



Item #	Description
136	Glow Plug Bore Reamer Set 4 pcs.
138-1	Glow Plug Reamer M12 x 59 mm
138-2	Glow Plug Reamer M12 x 94 mm
138-3	Glow Plug Reamer M10 x 107 mm



Glow Plug Electrodes Removal Tool Set | M8 / M10

- for dismantling glow plug electrodes
- suitable for glow plug threads M8 x 1.0 - M10 x 1.0 - M10 x 1.25
- extractor spindle M4 x 0.7 x 100 mm
- extractor spindle M4 x 0.7 x 100 mm
- extractor spindle M3 x 0.5 x 100 mm
- twist drill 3.3 x 140 mm
- twist drill 2.5 x 120 mm
- tap M4 x 0.7
- tap M3 x 0.5
- spindle guide M10 x 1.25
- spindle guide M10 x 1
- spindle guide M8 x 1
- guide bolt M10 x 1.25 (inner diameter 3.5 mm)
- guide bolt M10 x 1 (inner diameter 3.5 mm)
- guide bolt M8 x 1 (inner diameter 3.5 mm)
- guide bolt M8 x 1 (inner diameter 2.5 mm)
- guide bolt M8 x 1 (inner diameter 2.5 mm)
- guide bolt M10 x 1 (inner diameter 4.5 mm)
- guide bolt M10 x 1.25 (inner diameter 4.5 mm)
- guide bolt M10 x 1.0 (inner diameter 3.5 mm)
- guide bolt M10 x 1.25 (inner diameter 3.5 mm)
- spindle nut M4 x 0.7
- spindle nut M4 x 0.7
- spindle nut M3 x 0.5



Item #	Description
8698	Glow Plug Electrodes Removal Tool Set M8 / M10
8698-1	Twist Drill long for BGS 8698 2.5 x 120 mm
8698-2	Twist Drill long for BGS 8698 3.3 x 140m
8698-3	Tap long for BGS 8698 M3 x 0.5
8698-4	Tap long for BGS 8698 M4 x 0.7

Glow Plug Bore Reamer Set

- cleaning is recommended before installation of new glow plugs
- suitable for glow plug threads M8 - M10 - M12
- 145 mm drive shaft, knurled, for hand use
- can also be used with 14 mm hexagon socket or 6.3 mm (1/4") external square
- material: CR-MO + S45C steel
- 4 adaptors
- 3 reamers



Item #
8447

Glow Plug Removal and Thread Repair Set | M8, M10 | 17 pcs.

- simplifies the assembly and disassembly and professional repair of glow plug threads
- extractor for fixed glow plugs
- step drills to drill out damaged glow plugs 7 x 5.5 mm and 9 x 5.5 mm
- taps for regrooving of the glow plug threads: M8 x 1.0 mm - M10 x 1.0 mm - 6.3 mm (1/4") x 28UNF
- ratchet tap holder
- E-type socket E10



Item #	Description
8297	Glow Plug Removal and Thread Repair Set M8, M10 17 pcs.
8297-1	Step Drill 5.5 - 7 mm for BGS 8297
8297-2	Step Drill 5.5 - 9 mm for BGS 8297
8297-3	Threaded Studs for BGS 8297
8297-4	Guide Sleeve 40 x 6 x 3.5 mm

Repair Set for Glow Plug Threads

- for repairing the glow plug mounting thread in the cylinder head
- reamer for reaming the original thread
- taps for threaded sleeves
- taps for trimming the original thread
- assembly tools for inserting the threaded sleeves
- BGS 8647
 - 5 threaded sleeves M8 x 1.0 (11 mm long)
- BGS 8648
 - 5 threaded sleeves M9 x 1.0 (11 mm long)
- BGS 8649
 - 5 threaded sleeves M10 x 1.25 (12 mm long)
- BGS 8650
 - 5 threaded sleeves M10 x 1.0 (12 mm long)
 - 5 threaded sleeves M10 x 1.0 (19 mm long)
- BGS 8651
 - 5 threaded sleeves M12 x 1.25 (12 mm long)
 - 5 threaded sleeves M12 x 1.25 (19 mm long)
 - 5 threaded sleeves M12 x 1.25 (26 mm long)

Item #	Description
8647	Repair Kit for Glow Plug Threads M8 x 1.0
8647-1	Thread Sleeve 11 mm M8 x 1.0
8648	Repair Kit for Glow Plug Threads M9 x 1.0
8648-1	Thread Sleeve 11 mm M9 x 1.0
8649	Repair Kit for Glow Plug Threads M10 x 1.25
8649-1	Thread Sleeve 12 mm M10 x 1.25
8650	Repair Kit for Glow Plug Threads M10 x 1.0
8650-1	Thread Sleeve 12 mm M10 x 1.0
8650-2	Thread Sleeve 19 mm M10 x 1.0
8651	Repair Kit for Glow Plug Threads M12 x 1.25
8651-1	Thread Sleeve 12 mm M12 x 1.25
8651-2	Thread Sleeve 19 mm M12 x 1.25
8651-3	Thread Sleeve 26 mm M12 x 1.25



Repair Kit for Glow Plug Threads | M8 - M9 - M10 - M12

- for repairing the glow plug mounting thread in the cylinder head
- 5 reamers for reaming the original thread M8 x 1.0 mm - M9 x 1.0 mm - M10 x 1.0 mm - M10 x 1.25 mm - M12 x 1.25 mm
- 5 taps for threaded sleeves M8 x 1.0 mm - M9 x 1.0 mm - M10 x 1.0 mm - M10 x 1.25 mm - M12 x 1.25 mm
- 5 taps for trimming the original thread M8 x 1.0 mm - M9 x 1.0 mm - M10 x 1.0 mm - M10 x 1.25 mm - M12 x 1.25 mm
- 5 assembly tools for inserting the threaded sleeves
- 5 threaded sleeves M8 x 1.0 mm (11 mm long)
- 5 threaded sleeves M9 x 1.0 mm (11 mm long)
- 5 threaded sleeves M10 x 1.25 mm (12 mm long)
- 5 threaded sleeves M10 x 1.0 mm (12 mm long)
- 5 threaded sleeves M10 x 1.0 mm (19 mm long)
- 5 threaded sleeves M12 x 1.25 mm (12 mm long)
- 5 threaded sleeves M12 x 1.25 mm (19 mm long)
- 5 threaded sleeves M12 x 1.25 mm (26 mm long)

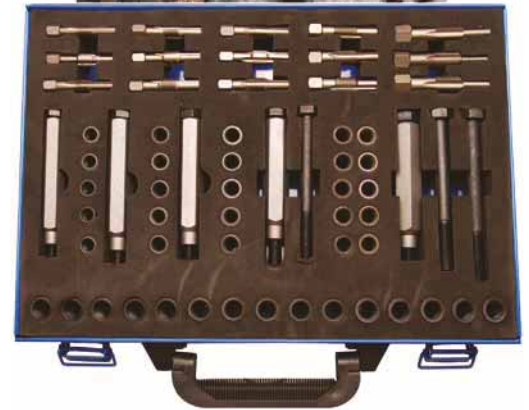

Item #
8653

Piston Ring Compressor Set | 7 pcs.

- incl. self-adjusting ratcheting piston ring compressor pliers and 6 exchangeable compressors 73 - 79 mm, 79 - 86 mm, 86 - 92 mm, 92 - 98 mm, 98 - 105 mm, 105 - 111 mm
- tension band height: 40 mm

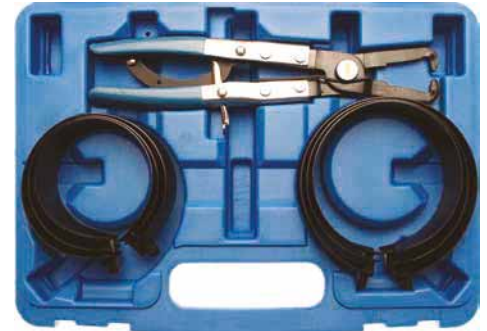

Item #
1874

Piston Ring Compressor

- spring loaded construction
- for damage-free assembly and disassembly of piston rings



Item #	Description
1887	Piston Ring Compressor 60 - 90 mm
1888	Piston Ring Compressor 57 - 125 mm
1889	Piston Ring Compressor 100 - 160 mm

Piston Ring Pliers

- enables non-destructive disassembly and assembly and prevents uncontrolled movement of the piston rings



Item #	Description
8374	Piston Ring Pliers 40 - 100 mm
8370	Piston Ring Pliers 80 - 120 mm
8371	Piston Ring Pliers 110 - 160 mm



Piston Ring Pliers | 205 mm

- allows easy and damage-free assembly of piston rings
- head made of hardened steel
- handle made of profile steel, spring mechanism

Item #
66103



Brake Cylinder Honing Tools

6.3 1/4

- 6.3 mm (1/4") drive shaft
- no cuts in the cylinder due to adjustable pressure
- jaws with grain size # 220
(# 180 for item 1157)



Item #	Description
1155	Honing Tool, 2-arm Ø 38 - 60 mm 30 mm Jaws
1145	Replacement Jaws for Honing Tool BGS 1155 Jaws 30 mm K 220 2 pcs.
1156	Honing Tool, 3-arm Ø 58 - 80 mm 50 mm Jaws
1146	Replacement Jaws for Honing Tool BGS 1156 Jaws 50 mm K 220 3 pcs.
1157	Honing Tool, 3-arm Ø 58 - 168 mm 100 mm Jaws
1258	Replacement Jaws for Honing Tool, BGS 1157 Jaws 75 mm K 280 3 pcs.
1147	Replacement Jaws for Honing Tool BGS 1157 Jaws 100 mm K 180 3 pcs.
1257	Replacement Jaws for Honing Tool BGS 1157 Jaws 100 mm K 280 3 pcs.



Hand Pump | 200 ml

- suitable for engine, transmission, rear axle oil and coolant
- transparent housing for checking fluids
- piston with double sealing rings
- the hand pump is also suitable for brake fluid by replacing the installed sealing rings with BGS 4067-1
- housing material: plastic
- tank capacity: 0.2 l



Item #	Description
4067	Hand Pump 200 ml
4067-1	Fluororubber Seals for BGS 4067

Hand Pump | 1500 ml

- suitable for engine, transmission, rear axle oil and coolant
- transparent housing for checking fluids
- piston with double sealing rings
- the hand pump is also suitable for brake fluid by replacing the installed sealing rings with BGS 4068-1
- housing material: plastic
- tank capacity: 1.5 l



Item #	Description
4068	Hand Pump 1500 ml
4068-1	Fluororubber Seals for BGS 4068

Fluid Extractor | 4 l

- for extracting all types of engine, transmission and lubricating oils, also suitable for low viscosity fluids such as water
- useable for cars, motorcycles, marine engines and industrial machinery
- manually operated by hand pump, independent of compressed air etc.
- scale with 0.5-l increments



Item #
3156

Suction Gun | 500 cm³

- can also be used for gearbox and engine oil
- includes 2 transparent hoses for suction/drain (1.20 m each)
- overall length (without hose): 330 mm
- diameter 58 mm
- hose inner diameter 9.5 mm
- suitable for oil and antifreeze



Item #
3064

Multi Purpose Pump

- for filling and refilling liquids out of the multi purpose pump, not suitable for suction
- suitable for oil, brake fluid and cleaning fluid
- overall size 315 mm, capacity 1000 ml
- the pump is not suitable for gasoline and other easy flammable liquids



Item #
8356

Emergency Pump / Transfer Pump

- for transfilling e.g. oil, water, antifreeze, etc.
- astonishingly effective
- hose length approx. 1.75 m
- hose inner diameter 9 mm
- not suitable for fuel and other flammable fluids



Item #
4064



Hose Pump

- the flexible hose pump is a pump for decanting water, diesel fuel and cleaning agents as well as other types of chemicals
- no manual suction necessary, which means no danger of swallowing unpleasant smelling or tasting liquids.
- internal diameter: 12 mm, external diameter: 17 mm
- 180 cm hose length
- not suitable for gasoline and other highly flammable liquids

just follow these three easy steps:

1. Place the suction head in the liquid which should be on a higher level and place the other end of the tube in a container below it.
2. Move the suction head quickly up and down a few times.
3. The liquid will automatically begin to flow through the tube.



Item #
4066



Filling Tube for Urea (AUS32)

- ideal for refilling urea additives
- allows a clean refill, no contamination or odour in the interior
- can be used in passenger cars and vans
- suitable for 5 and 10 litre canisters
- to be used as VAG 000012499
- hose length: 1 m



Item #
9329



Diesel Service Filling Pump

- for filling the fuel system
- is required when renewing diesel filters and other components of the diesel injection system
- prevents defects of high pressure pumps (CDI) which frequently occur when renewing filters without manual filling

Item #
4063



Multi Purpose Funnel | Metal Version | Ø 145 mm

- with flexible neck and sieve
- filling pipe length 300 mm
- material: metal
- funnel diameter 145 mm

Item #
8030



Multi Purpose Funnel | Ø 160 mm

- suitable for oil, anti freeze, diesel etc.
- closes by sliding a ring and by closing a plug at the end of the hose
- length: 400 mm
- filling hose diameter 12.5 mm
- funnel diameter 160 mm

Item #
8406



Flexible Funnel | 220 - 120 mm

- particularly useful in poorly accessible oil filling openings
- malleable



Item #
8446-1

Fluid Flasks with flexible spout and lid

- material: HDPE
- suitable for brake fluid, battery fluid and non-acidic liquids
- incl. flexible nozzle and lockable cask cover
- with threaded nozzle for fillers
- colour: white / transparent



Item #	Description
9938	Fluid Flask with flexible spout and lid 1 l
9939	Fluid Flask with flexible spout and lid 2 l
9943	Fluid Flask with flexible spout and lid 3 l
9944	Fluid Flask with flexible spout and lid 5 l

Fluid Flasks

- acid, oil and alkali resistant
- with threaded nozzle for fillers (filler not included)



Item #	Description
8568	Fluid FLask 1 l
9983	Fluid FLask 2 l
9984	Fluid FLask 4 l
8569	Fluid FLask 5 l

Pouring Spout for Oil Cans | for BGS 8568, 8569, 9983, 9984

- flexible
- facilitates filling



Item #
9988

Cooling Water Can | with long Filler Neck | 5 l

- small opening, especially suitable for filling cooling systems and windscreen washer systems



Item #
9164

Measuring Cup Set | 3 pcs.

- 500 ml measuring tube with 50 ml bar scale
- 1000 ml measuring tube with 50 ml bar scale
- 2000 ml measuring tube with 100 ml bar scale



Item #
9946

Engine Stands

- rotates 360° and can be locked in 8 positions
- ball bearing castors
- 4 turnable plate mounting points, adjustable
- turnable plate allows easy turning of the engine



Item #	Description
9231	Engine Stand 450 kg
9230	Engine Stand XL 560 kg

Heavy Duty Gearbox Lifter | 500 kg

- for assembling and disassembling engines, gearboxes and rear axles
- adjustable head plate, 60 mm to the side and from -10° to 35° in inclination, therefore especially suitable for mounting of automatic transmissions
- height approx. 880 - 1770 mm
- 4 ball bearing caster wheels
- heavy duty construction
- fast lifting due to hydraulic foot pedal
- weight: 80 kg



CE

Item #	Description
9233	Heavy Duty Gearbox Lifter 500 kg
9233-1	Replacement Wheel for BGS 9233
9233-2	Hydraulic Cylinder for BGS 9233

Gearbox Lifter | 600 kg

- for assembling and disassembling of gearboxes, rear axles and suspension parts
- swivel saddle
- height approx. 1130 - 1970 mm
- 4 ball bearing caster wheels
- heavy duty construction
- 840 mm stroke
- fast lifting due to hydraulic foot pedal
- weight: 34 kg



Item #
9239

CE

Engine Crane | 1000 Kg

- engine crane for lifting engines and other heavy loads
- lifting arm can be adjusted in 4 positions of different length
- technical data:
 - capacity position 1: 1000 kg
 - capacity position 2: 750 kg
 - capacity position 3: 500 kg
 - capacity position 4: 250 kg
 - maximum height in position 1: 2019 mm
 - maximum height in position 4: 2248 mm
 - length of the lifting arm in position 1: 902 mm
 - length of the lifting arm in position 2: 1003 mm
 - length of the lifting arm in position 3: 1080 mm
 - length of the lifting arm in position 4: 1169 mm
 - frame length: 1257 mm
 - overall height: 1400 mm
- foldable



Item #	Description
9245	Engine Crane 1000 Kg
9245-1	Hydraulic Cylinder for Engine Crane BGS 9245



Engine Crane | Double Piston Type | 2000 kg

- especially suitable for disassembly / assembly of heavy drive units
- folding mechanism for space-saving storage
- capacity up to 2000 kg
- lifting height: 25 - 2300 mm
- dimensions: (L x W x H) 1800 x 1040 x 1568 mm
- dimensions, folded: (L x W x H) 850 x 800 x 1645 mm
- weight approx. 99 kg



Item #
9249



Engine Support | 750 - 1450 mm

- for assembling and disassembling of engine and gearbox
- strong square-type tube
- slot for flexible width adjustment
- hooks with 16 mm threaded rods
- ball bearing wheels
- rubber pads protect fenders
- 9235 comes with two chains, 9234 with one (each chain 90 cm long)



Item #	Description
9234	Engine Support 750 - 1450 mm 300 kg
9235	Engine Support XL 750 - 1450 mm 500 kg
9234-1	Spinner Handle with Internal Thread for BGS 9234, 9235
9234-2	Spinner Handle with External Screw Thread for BGS 9234

Engine Support with Crossbeam | 400 - 1400 mm | 500 kg

- for disassembling and assembling of gearboxes, etc.
- sturdy construction from square steel tube
- very wide adjustment range in length and width
- rubberised support feet prevent slipping as well as damage to the surface
- maximum load capacity: 500 kg
- main beam width: 400 to 1,400 mm
- cross beam width: 140 to 810 mm
- incl. 2 spindles with hook
- length: 410 mm
- width: 320 mm

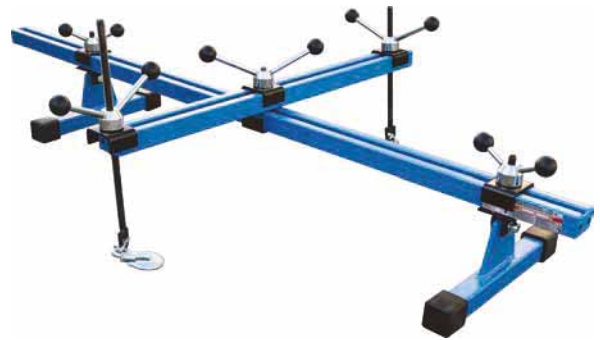

Item #
9254

Engine Mounting Balancer

- for balancing engines when lifting with an engine crane
- allows a precise alignment when installing the engine on gearbox
- capacity: 350 kg
- dimensions: 280 x 390 mm
- adjustment: +/- 160 mm
- chain length: 2x 350 mm (incl. mounting bracket)
- crank length: 100 mm

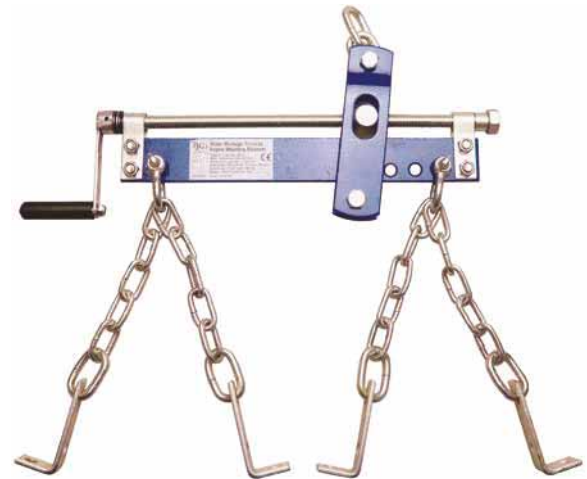

Item #
8492

Universal Engine Support with 2- and 3-point Receptacles | 315 kg

- 2- and 3-point support on car wing edges and hood latch
- support is provided on the fender screw edges and, if necessary, on the radiator support
- wide area of application due to adjustable suspension points
- incl. 2 pendant ropes
- cross beams width: 1000 - 1550 mm
- longitudinal beam length: 24-fold adjustable: 90, 120, 150, 180, 210, 240, 270, 300, 330, 360, 390, 420, 450, 480, 510, 540, 570, 600, 630, 660, 690, 720, 750, 780 mm
- supporting foot height (longitudinal beam): 100 - 130 - 160 - 185 - 210 - 240 mm
- supporting foot height (cross beams): 105 mm
- capacity: 315 kg



Item #
8515

Engine / Gearbox Support | 690 - 1050 mm

- secure support of engine or gearbox during assembly
- is required for e.g. disassembly of the engine mount, timing belt and replacement of clutch
- sturdy square tube construction
- feet and support plate are height adjustable and lockable
- rotatable retaining hooks, adjustable in height by hand wheel
- slidable and fixable crosspiece and retaining hook
- support plate with non-slip rubber pad
- especially suitable for large fender angle, where a mounting of engine bridge is very difficult
- suitable for many common vehicles
- length of the longitudinal beam: 690 up to 1050 mm
- max. retaining hook distance: 500 mm
- crossbeam supporting foot distance: 450 mm



Item #
8606

Engine Support with 4-point support | 510 - 845 mm | 315 kg

- especially suitable for vehicles with auxiliary frame
- prevents undesired twisting and tilting of the engine
- 2 positionable longitudinal beams for support on front panel
- rubber protected front panel support feet
- positionable 2 hook support
- can also be used without longitudinal beams
- including two chains and shackles, length 530 mm
- variable width, up to 1500 mm
- variable length of longitudinal beams 510 - 845 mm
- lifting spindle length 340 mm
- capacity: 315 kg
- max. width 1500 mm



Item #
9237

Windshield Holder / Multi-Purpose Table

- ideal for storage of windshields and car body parts, e.g. when removing or applying adhesive materials, etc.
- heavy duty construction
- adjustable and lockable in width and height, therefore can be stored in a small area
- 4 rolling wheels
- padded seating surface
- width: 220 - 1350 mm
- height: 840 - 1250 mm
- depth: 870 mm
- capacity: 100 kg



Item #
9238

Working Platform | foldable

- with one step
- platform area: 760 x 300 mm
- platform height: 495 mm
- low weight aluminum construction
- folded width: 413 mm
- height assembled: 165 mm
- length in hinged position: 790 mm
- weight: 3.6 kg
- base (L x W) 1090 x 415 mm
- max. capacity: 100 kg



Item #
8366

Hydraulic Double Piston Foot Pump

- suitable for all BGS hydraulic tools
- two step pressure rating:
 - 1. step: 13.8 bar (200 psi)
 - 2. step: 700 bar (10165 psi)
- oil capacity: 700 ml
- output per stroke
 - 1. step 13.0 ml
 - 2. step 2.8 ml
- oil port thread: 10 mm (3/8") NPT
- hose length 2.5 m



Item #
1613

Air Hydraulic Pump | 689 bar / 10,000 psi

- suitable for all BGS hydraulic tools
- compressed air supply: 6.2 - 9.6 bar
- compressed air connection: 6.3 mm (1/4") x 18 NPT
- pressure oil connection: 10 mm (3/8") x 18 NPT
- max. output pressure: 689 bar (10000 psi)
- oil tank capacity: 2.2 l
- usable oil capacity: 1.6 l
- weight: 8.5 kg
- dimensions: 261 x 135 x 185 mm



Item #
1609

Hydraulic Hose with Coupling | 1.8 m

- for use with e. g. BGS 1609
- max pressure: 689 bar (10000 psi)
- length: 1.8 m



Item #
1611

Hydraulic Adaptor 10 mm (3/8") NPT x 13/16" x 16 UNF

- quick-action coupling for hydraulics



Item #
1613-1

Aluminium Caulking Guns

- thick wall type
- BGS 3511: for 220 mm cartridges
- BGS 3513: for 380 mm cartridges and 600 ml bags



Item #	Description
3511	Aluminium Caulking Gun, for Cartridges 220 mm
3513	Aluminium Caulking Gun, for Cartridges 380 mm

Spare Nozzle for Standard Cartridges

- suitable for all standard cartridges
- consisting of tip and pressure plate

Item #
3512



Skeleton Type Caulking Gun | heavy duty

- extra heavy and solid type
- length: 300 mm
- weight: 460 g

Item #
3510



Lever Type Grease Gun

- supplied complete with delivery tube
- for 400 cm³ / 220 mm cartridges
- optional accessories: flexible delivery tube BGS 3066, mouthpiece BGS 3143
- length: 300 mm

Item #	Description
3065	Lever Type Grease Gun
3065-1	Nozzle Pipe for BGS 3065



Single Handed Grease Gun | 500 cm³

- for use with standard cartridges 220 mm, 400 g and bulk grease
- incl. delivery tube and mouth piece
- optional accessories: flexible delivery tube BGS 3066
- max. container size 500 cm³

Item #
3140



Mini Grease Gun | 125 cm³

- easy to use with one hand
- load capacity: 125 cm³
- exchangeable delivery tube
- optional: flexible delivery tube BGS 3066

Item #
3141



Grease Gun Accessory Kit | 7 pcs.

- 90° lube tip
- straight extension
- 300 mm hose extension
- 90° adaptor
- 360° adaptor
- rubber-tipped nozzle
- needle nozzle
- for grease gun no. 3065, 3140, 3141, 3175, 3236

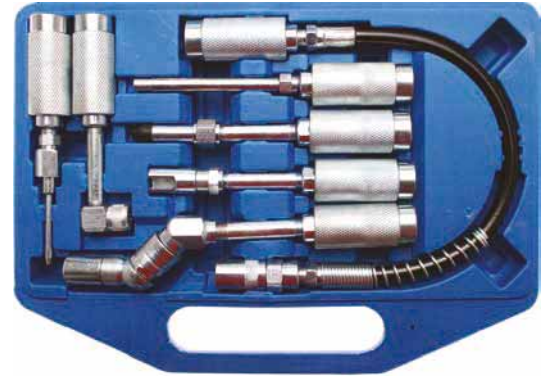

Item #
3142

Delivery Tip for Grease Gun

- can be used with air hose
- thread 1/8" PT

Item #	
3143	



Flexible Delivery Tube for Grease Gun | 300 mm

- for grease gun nr. 3065, 3140, 3141, 3236
- mounting thread: NPT 1/8" x 27

Item #	
3066	



Mini Grease Gun with 100 g Lithium Grease (1 Tube)

- for the lubrication of beaters and spindles
- ideal for bike maintenance, for lubricating pedals, hubs, etc.
- suitable for squeeze grease tubes with M14x1.5 thread
- max. pressure: up to 68 bar
- output: approx. 0.45 g per stroke
- incl. 100 g grease tube
- temperature range: 10°C - 120°C
- dropping point: 180°C



Item #	Description
9311	Mini Grease Gun with 100 g Lithium Grease (1 Tube)
9312	Lithium Grease for Grease Gun BGS 9311 2 Tubes



Precision Oiler

- fine control tip
- protection cap
- special „drop protect" pump head
- aluminium body
- for various applications: automotive area, oil, atomizing, model-railway, locks, sewing machine hinge, power machines and many other mechanical uses



Item #
9985



Plastic Oil Can | 250 ml

- good handling
- easy to dose oil volume
- very useful when cutting threads



Item #
8441

LED Pen with 6 LEDs

- 6 bright LEDs
- particularly useful due to small dimensions
- fits in any pocket and is therefore always at hand
- with clip-holder
- LED 5 mm, 6 pcs.
- battery 1.5V AAA, 3 pcs. included
- length: 158 mm
- width: 33.5 mm
- height: 16.5 mm



Item #
8491



Aluminium LED Pen with 9 LEDs

- aluminium housing
- 9 ultra-strong LED
- with clip-holder
- magnet in swiveling clip
- battery: 1.5V AAA, 3 pieces
- length: 158 mm
- width: 22 mm
- height: 25 mm



Item #
8493



Extendable LED Flashlight with Magnetic Pick Up Tool | "2-IN-1"

- 170 to 545 mm extendable telescopic magnetic lifter with flexible gooseneck for lifting metal objects like screws, tools, coins etc.
- 3 energy-efficient, durable and bright LEDs
- aluminum housing with mounting clip
- magnetic holding force 1 kg
- diameter 25 mm
- includes 4 LR44 batteries



Item #
9303



LED Multi-Function Flashlight | 3 W

- highpower LED lamp
- brightness 160 lm
- illumination time 3 h
- waterproof IP63
- housing made of anodised aluminium
- Li-Ion battery 3.7 V / 2000 mAh (type 18650)
- AC charger input 110 - 240 V / 50 Hz, suitable for battery 3.7 V / 2000 mAh (type 18650)
- length: 149 mm
- width: 39 mm
- height: 39 mm



Item #
9775



COB LED Head Lamp

- very wide and bright illumination
- lamp angle adjustable up to 60°
- head circumference: 50 - 70 cm
- lamp: ultra bright 3 W COB LED
- brightness 120 lm
- battery: 3x 1.5V AAA
- length: 60 mm
- width: 50 mm
- height: 40 mm
- material: abs plastic
- weight: 50 g



Item #
85314



Workshop Hand Lamp | 11 W | 220 V

- very rugged hand lamp with 2 neon tubes
- ensures glare-free working
- protection class IP54, protected against splashing water
- equipped with 5 m neoprene cable and metal hook

Item #
9704



Cordless Workshop Flashlight | COB-LED | 3W

- ensures equal illumination
- helpful for maintenance, inspection and repair work
- hanging hook
- COB LED
- 250 lumen
- charging time: approx. 4 - 5 h
- charger input: 100 - 240V AC 50 Hz
- charger output: 5V DC 500 mA
- accumulator power (electric charge): 2.2 Ah
- accumulator type: Li-Ion
- autonomy 3 h

Item #
85301



Cordless Handheld Lamp | COB-LED | waterproof | 5W

- COB LED technology, dimmable up to 50%
- 3 to 4 hours of continuous operation with one charge
- can also be used with connected charging adaptor
- LED type: COB LED 5 Watt
- LED brightness: 500 / 300 lm
- LED colour temperature: 6500K
- accumulator type: 2 pcs. 18650 lithium-ion 4000 mAh
- 2-colour LED for battery capacity and charge control
- with hooks
- impact resistant
- working temperature: -20 up to +60°C
- incl. 230V charger and charging cable
- dimensions (without hooks): 315 x 56 x 41.5 mm
- weight: 0.3 kg
- accumulator power (electric charge): 4.0 Ah
- accumulator type: Li-Ion
- autonomy: 3-4 h
- protection class: IP 67

Item #
85322



Cordless Bendy Lamp | COB-LED | 5W

- COB LED technology, dimmable up to 50%
- additional SMD LED light in the lamp head
- lamp head 170° foldable and 270° rotatable
- 4 to 8 hours of continuous operation with one charge
- with hook & magnet in lamp bottom
- can also be used with connected charging adaptor
- LED type: 5 SMD + 1x 5W COB
- LED brightness: 500 / 300 lm
- LED colour temperature: 6500K
- accumulator type: 2 pcs. 18650 lithium-ion 4000 mAh
- 2-colour LED for battery capacity and charge control
- impact resistant
- working temperature: -20 up to +60°C
- incl. 230V charger and micro USB charging cable
- dimensions (folded): 185 x 69 x 45 mm
- weight: 0.3 kg
- accumulator power (electric charge): 4.0 Ah
- accumulator type: Li-Ion
- autonomy: 4 -8 h
- protection class: IP 65



Item #
85321



COB-LED Work Handheld Lamp | ultra flat Type

- ensures equal illumination of the work area
- especially suitable for narrow places thanks to small dimensions
- COB LED power: max. 15 W
- brightness continuously adjustable through control knob
- working time (max. brightness): approx. 2.5 h; at reduced brightness approx. 12 h
- swivel base with powerful magnet
- swivel hanging hook
- charging display LED
- USB charger 5 V (DC) / 1.0 A
- accumulator power (electric charge) 2.2 Ah
- accumulator charging time: 4 h



Item #
85319



COB LED Working Light

- with COB LED technology
- 4x brighter than standard LED lamps
- perfectly even and bright light
- with hanging hook
- comfortable swivel anti-slip handle
- magnetic base
- lithium-Ion battery, 3.7 V / 2200 mAh, for faster charging
- incl. AC main charger and 12V adaptor cable
- length: 185 mm
- width: 55 mm
- height: 35 mm



Item #
85317



COB LED Workshop Lamp with Magnet and Hook

- with COB LED light strip technology for bright light
- rechargeable battery
- in 9 positions by 180° adjustable magnetic feet
- 2 magnets on the back
- 2 folding hooks
- incl. battery charger
- LED type: 3W COB LED
- brightness: 250 LM
- working time: approx. 2.5 hours
- IP20 waterproof
- length: 280 mm
- height: 62 mm
- depth: 43 mm
- accumulator power (electric charge): 2.0 Ah
- accumulator voltage 3.7 V
- accumulator type: Li-Ion
- autonomy: 2.5 h
- protection class: IP 20



Item #	 
85316	

LED Battery Bonnet Lamp

- robust design with telescopic mounting brackets
- soft padded hooks provide good protection against damages to the bonnet
- 120 LEDs with 120° spread of light give complete engine bay illumination
- battery: Li-ion 7.4 V / 2.0 Ah
- capacity: 7 W
- lamp type: LED, 120 pieces
- min. bonnet width: 1290 mm
- max. bonnet width: 2190 mm
- operating time: approx. 4 h
- charging time: approx. 6 h
- incl. 230V charger and 12V car charging cable



Item #	
85412	

Under Bonnet Working Lamp

- with fluorescent tube type T8, 30 watt (890 mm)
- **with telescopic bar**, extends 110 to 190 cm
- 360° swivel hook
- 4.5 m (230 V)



Item #	Description
85305	Under Bonnet Working Lamp
85305-1	Replacement Tube for BGS 85305 30 W / 230 V



Energy Saving Work Light | 38 W

- with 1 VDE socket on the backside (max. 3600 W)
- dimensions: approx. 27 x 27.5 x 13 cm (L x W x H)
- 1.8 m cable (H07RN-F 3G 1.5mm²) with VDE plug
- protected against spray water
- adjustable stand and handle



Item #	Description
85320	Energy Saving Work Light 38 W
85325	Spare Lighting for BGS 85320 38W GR10q

3-in-1 Claw Combination Tool | 500 mm

- useful 3-in-1 tool
- claw
- magnetic lifter
- light
- light and claw are also integrated in the magnetic tip
- total length with light: 585 mm
- length: 500 mm



Item #	
3197	

Flexible Pick Up Tool | Steel | 595 mm

- all steel made construction
- length: 595 mm



Item #	
3102	

Magnetic Lifter / flexible claw Tool

- magnetic power approx. 800 g
- claw opening up to 23 mm
- claw tool for picking up small parts (screws, nuts etc.) in hard to reach places
- magnetic pick up tool for all small metal parts
- length: 700 mm



Item #	
3094	

Universal Support Hook 200 - 520 mm

- easily adjustable with thumb screw
- working range: 200 - 520 mm
- applicable as holder for vehicle parts like steering knuckle or brake calliper, oil and brake pipes to avoid damages
- for fastening and holding of vehicle parts such as axle legs or brake calliper, oil and brake pipes to avoid damages



Item #
9390

Magnetic Pick-Up Tool | flexible | 500 mm | Capacity 0.5 kg

- capacity up to 500 g
- extra thin magnetic head Ø 6 mm
- 2-component handle

Item #
3089



Magnetic Pick-Up Tool | flexible | 500 mm | Capacity 1 kg

- capacity up to 1 kg
- magnet head Ø 10 mm
- 2-component handle

Item #
3154

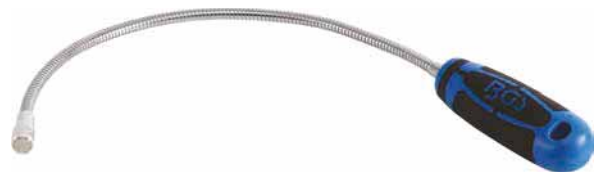

Magnetic Pick-Up Tool | flexible | 500 mm | Capacity 2 kg

- capacity up to 2 kg
- magnet head Ø 12.5 mm
- 2-component handle

Item #
3158



Magnetic Pick-Up Tool | flexible | 500 mm | Capacity 3 kg

- capacity up to 3 kg
- magnet head Ø 16.5 mm
- 2-component handle

Item #
3159



Magnetic Pick-Up Tool with LED | 600 mm | Capacity 1.5 kg

- capacity up to 1.5 kg
- with strong LED lamp on magnetic tip
- gooseneck Ø 8 mm
- magnet diameter: 17.5 mm
- 2-component handle

Item #
3187



Claw / Magnetic Lifter / Combination Light Tool | 615 mm

- bright LED for good illumination
- strong magnet, lifts up to 500 g
- length: 615 mm

Item #
3174



Magnetic Lifter | 660 mm | Capacity 0.5 kg

- head diameter 7 mm
- with nozzle cleaner
- incl. clip holder
- length: 660 mm

Item #
3091



Magnetic Pick-Up Tool with flexible tip | 580 mm | Capacity 1.6 kg

- magnetic end diameter: 13 mm
- capacity up to approx. 1.6 kg
- clip holder
- max. length 580 mm
- surface finish: chrome plated

Item #
3183



Magnetic Lifter | 670 mm | Capacity 2.2 kg

- high capacity (up to 2200 g)
- extendable
- head Ø 13 mm
- handle with belt clip

Item #
3088



Magnetic Lifter | 650 mm | Capacity 3 kg

- chrome plated - magnetic tip diameter: 15 mm
- the removable tip sleeve prevents from having a sideward magnetic effect so that only those parts you want to pick up are magnetically attracted
- rubber handle with clip holder
- max. length 650 mm



Item #
3188



LED magnetic Pick-Up Tool and Inspection Mirror Set

- 1 magnetic pick up tool with LED light extendable to 665 mm, capacity 450 g
- 1 magnetic pick up tool extendable to 665 mm, capacity 3500 g
- 3 inspection mirrors, mirror Ø 21 - 31 - 38 mm
- practical storing pouch
- incl. batteries



Item #
3095

Mini Magnetic Holder Set | 45° - 90° - 135° | 4 pcs.

- useful for aligning and welding metal sheets
- holding force: 4 kg
- length: 72 mm
- width: 43 mm
- height: 11 mm



Item #
3004



Powerful Magnetic Holders

- 8 separate magnetic areas



Item #	Description
3007	Powerful Magnetic Holder 11 kg
3008	Powerful Magnetic Holder 20 kg
3009	Powerful Magnetic Holder 32 kg



Inspection Mirror | Ø 55 mm

- flexible shaft
- length: 475 mm

Item #
3081



Inspection Mirror | 63 x 45 mm

- for inspecting hard-to-access areas
- telescopic length: 165 - 655 mm
- stainless steel mirror surface: 63 x 45 mm
- anti-slip grip, 110 mm

Item #
8966



LED Telescope Inspection Mirror | 285 - 870 mm

- non-slip telescopic grip
- rotating and folding mirrors
- mirror size: 41 x 62 mm
- 2 LEDs
- incl. battery
- length: 285 - 870 mm

Item #
9302

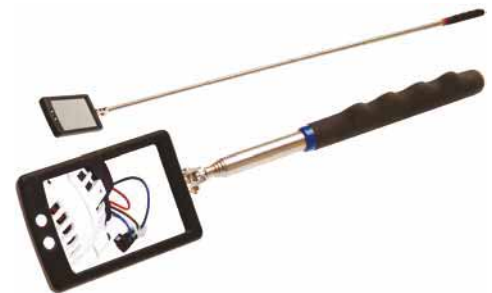

Telescopic Inspection Mirror | Ø 200 mm

- especially suitable for visual examination under a vehicle to find oil leaks or corrosion
- aluminium telescopic handle adjustable from 660 mm to 1090 mm
- mirror diameter 200 mm
- shatterproof acrylic mirror
- adjustable mirror angle
- ergonomic handle

Item #
3176



Pry Bar Set | 4 pcs.

- slip guard handles with steel head
- pry bar 200 x 11 mm - 300 x 17 mm - 450 x 19 mm - 600 x 20 mm



Item #	Description
9137	Pry Bar Set 4 pcs.
9137-1	Pry Bar 200 x 11 mm
9137-2	Pry Bar 300 x 17 mm
9137-3	Pry Bar 450 x 19 mm
9137-4	Pry Bar 650 x 20 mm



Pry Bar Set | 4 pcs.

- 4 different pry bars for all kinds of applications on trucks and other heavy vehicles
- 2 bars 600 mm long and 2 bars 900 mm long
- straight and 30° - 75° - 90° bent
- rubber coated soft-grip

Item #
9133

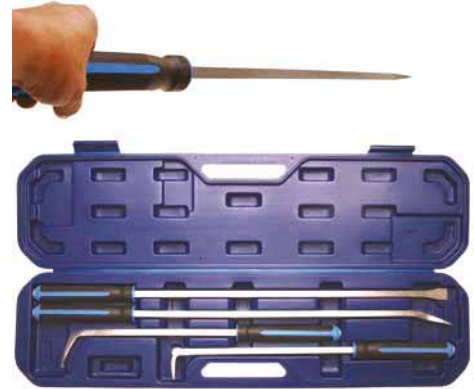

Pry Bar Set | 4 pcs.

- hardened black finished carbon steel
- plastic handles with guarding caps
- sizes: 200 x 12 mm - 300 x 18 mm - 450 x 20 mm - 600 x 20 mm

Item #
9135



Pry Bar | 780 mm

- with acid resistant handle
- handle length 205 mm
- dimensions of square profile handle: 35 x 35 mm
- head width: 16 mm
- head thickness: 2 mm
- dimensions of square rod: 16 x 16 mm
- length: 780 mm
- surface finish: satin chrome plated

Item #
9134



Oil Pan Separating & Cleaning Set | 19 pcs.

- for separating of sealed components, e. g. oil pans on engines and gearboxes or other difficult to separate seals
- additional copper blade prevents damage to e. g. aluminium oil pan sealing surfaces
- 1 separating tool with replaceable blade
- 1 replacement copper blade
- 1 hexagon key wrench, 2.5 mm
- 1 cleaning adaptor for drill
- 15 cleaning discs Ø 20 mm



Item #
9327



Oil Drum Cart | Standard Type | for 200 l Drums

- tubular steel structure with deep-welded joints
- suitable for upright movement of all common 200 litre barrels
- with 4 steel castor wheels for high flexibility
- platform base Ø: 650 mm
- corner height: 65 mm
- max. capacity: 400 kg



Item #
9479

Air Suction Oil Drainer | 70 l

- designed for extracting waste oils, such as on engines, gearboxes, rear axles, etc.
- with compressed air connection, makes it easier to empty the container
- large glass container to check the oil level
- with 4 castors, 2 swivel wheels for easy manoeuvring
- flexible suction pipes: Ø 5 - 6 - 7 and 8 mm
- metal suction pipes: Ø 5 and 6 mm
- emptying hose, 1.8 m



Item #	Description
8545	Air Suction Oil Drainer 70 l
8544-1	Replacement Castor for BGS 8544, 8545
8544-2	Replacement Rigid Roller for BGS 8544, 8545

Oil Drip Pan for Motorcycles | 2 l

- low height, especially suitable for motorcycles and scooters
- for changing oil and collecting used oil of e.g. clutch, gearbox, etc.
- capacity 2 l
- material: HDPE
- dimensions: 380 x 212 x 73 mm
- weight approx. 250 g



Item #

9994

Oil Tub / Drip Pan with Nozzle | 3.5 l

- resistant to most solvents up to 60°C
- acids, alkalis, alcohols, oil, gasoline
- material: HDPE
- dimensions: Ø 265 x 60 mm



Item #

9979

Oil Tub / Drip Pan with Nozzle | 8 l

- resistant to most solvents up to 60°C
- acids, alkalis, alcohols, oil, gasoline
- material: HDPE
- diameter: 400 mm
- height: 125 mm
- weight 650 g



Item #

9981

Oil Tub / Drip Pan with Nozzle | 15 l

- resistant to most solvents up to 60°C
- acids, alkalis, alcohols, oil, gasoline
- material: HDPE
- diameter: 570 mm
- height: 120 mm
- weight: 1075 g
- impact resistant

Item #
9980



Drip pan | 18 l

- for collecting coolants, oils, etc.
- length: 565 mm
- width: 420 mm
- height: 80 mm

Item #
9474



Drip Pan | 50 l

- for collecting coolants, oils, etc.
- with lowered corner for better emptying
- length: 880 mm
- width: 600 mm
- height: 100 mm

Item #
9997



Oil Changing Can with Nozzle | 8 l

- closed construction, special flat type (only 12 cm high)
- ideal for use in confined spaces
- special shaped oil basin makes sure no oil will get lost
- with 3 carrying-handles and 3 openings
- suitable for oil, petrol, chemicals and antifreeze

Item #
9982



Oil Changing Can | extra flat | 20 l

- especially suitable where a low tank height is required
- suitable for all fluids in the car such as cooling fluid, all kinds of oils, etc.
- filtering sieve for impurities
- drain and vent opening
- max. volume: 20 l
- overall dimensions: 850 x 600 mm
- dimensions of the collecting area: approx. 490 x 610 mm
- height: 100 mm
- movable, with 2 wheels

Item #
8719



Oil Changing Can with Nozzle | mobile | 40 l

- for collection of fluids, such as e. g. engine oil, transmission oil, rear axle oils and coolant fluids
- suitable for cars and motorcycles
- easy positioning by two wheels, Ø 100 mm
- closable drain, pouring and ventilation openings
- equipped with handles on both sides
- overall dimensions: 900 x 500 mm
- dimensions of the collecting area: approx. 350 x 320 mm
- height: 200 mm

Item #
8554



Oil Drip Pan | 60 l

- especially suitable for ground-level repairs and for storage of oily parts
- 4 castors and drawbar allow easy positioning
- hand-crank pump for emptying the oil pan
- hole plate cover for placing of components on it
- plastic tub with sheet steel reinforcement for a safe hold of the castors
- length: 1100 mm
- width: 700 mm
- height: 190 mm

Item #
9987



Oil Drip Pan for Trucks | 3 l

- for collecting oil during axle repairs
- suitable for commercial vehicles
- suitable for rim inner diameter over 350 mm
- with side opening for draining the oil
- capacity 3 l
- material: HDPE
- temperature range: - 40 °C to +80 °C
- dimensions: 316 x 246 x 156 mm



Item #

8720

Oil Drum Attachment for 200-l drums | 20 l

- oil drum attachment for emptying of oil filters
- discharge of waste oil and drop of oil filters
- to be placed on 200-l barrels
- secure fit
- reduces the risk of spillage
- black
- capacity: 20 l
- diameter 600 mm
- weight 1.7 kg
- material: polypropylene



Item #

8942

Oil Drum Attachment for 20 and 30-l drums | Ø 280 mm

- oil drum attachment for emptying of oil filters
- for installation on 20 / 30-l standard buckets or open-top containers with min. 280 mm diameter
- oil drain connects directly to the bucket opening
- with oil filter adaptor for simple and efficient draining of the oil filter
- made of chemical resistant polyethylene
- includes a filter for capturing of debris



Item #

9978

Transmission Oil Filling Tool with Hand Pump | with Return System | with 8 Adaptors | 7 l

- new version with 2 hoses for backflow of excessive oil
- with 8-pc adaptor set with different angles and thread types
- ideal for filling Mercedes-Benz 722.9 VW / Audi DSG and CVT transmissions
- for filling gearboxes and differentials with oil
- hose length 160 cm
- can be used up to SAE 140



Item #	Description
9991	Transmission Oil Filling Tool with Hand Pump with Return System with 8 Adaptors 7 l
9991-2	Replacement Container for BGS 9991

Transmission Filling Adaptor Set | 15 pcs.

- for filling of manual, automatic and DSG transmissions
- fits on oil filling tools BGS 9991, 9992

includes 15 adaptors, suitable for following models:

- adaptor 1/8"-27 NPT - Ford
- adaptor M10 x 1.0 - VW, Audi, MINI Cooper
- adaptor M24 x 1.5 - VW, Audi DSG
- Adaptor M22 x 1.5 - VW, Audi CVT
- ATF adaptor - VW Passat
- adaptor M12 x 1.5 - Mercedes-Benz
- adaptor M18 x 1.5 - Skoda
- adaptor M30 x 1.5 - Audi, VW, Skoda
- adaptor 5/16"-24 UNF - Volvo
- adaptor M18 x 1.5 - Toyota, Lexus
- adaptor M8 x 1.0 - Nissan, Infinity
- universal adaptor (flexible) - Honda, Hyundai, Kia, etc.
- universal adaptor - BMW, Honda, Nissan, etc
- adaptor - VW, Audi, Skoda, Seat
- adaptor for VW, Audi, Porsche



Item #
9992-1

Transmission Oil Filling Tool with Hand Pump | with 8 Adaptors | 7 l

- suitable for filling of manual and automatic transmissions
- viscosity range: SAE0 to SAE140
- capacity: 80 cm³ per cycle
- tank capacity: 7 l

includes the following 8 adaptors:

- adaptor for Ford, 1/8" 27NPT
- universal adaptor for BMW, Honda, Nissan etc.
- adaptor for VW, Audi
- adaptor for VW, Audi, Porsche
- adaptor for VW, Audi, MINI, M10 x 1.0
- adaptor for VW & Audi DSG, M24 x 1.5
- adaptor for VW & Audi CVT, M22 x 1.5
- adaptor for Mercedes-Benz 722.9, M12 x 1.0



Item #	Description
9992	Transmission Oil Filling Tool with Hand Pump with 8 Adaptors 7 l
9992-2	Empty Case for Adaptors for BGS 9992
9992-109	Filling Adaptor for BGS 9992 for Skoda
9992-110	Filling Adaptor for BGS 9992 for Audi, VW
9992-111	Filling Adaptor for BGS 9992 for Honda, Hyundai, Kia
9992-112	Filling Adaptor for BGS 9992 for Volvo
9992-113	Filling Adaptor for BGS 9992 for Lexus
9992-114	Filling Adaptor for BGS 9992 for Nissan, Infinity
9992-115	Filling Adaptor for BGS 9992 for Passat
9992-116	Filling Adapter for BGS 9992 for MINI Cooper
9992-118	Filling Adapter for BGS 9992 for Nissan Juke

Adaptor for Transmission Oil Filling Tool | for Audi, Mercedes-Benz, VW

- for clean filling of the gearbox
- suitable for Mercedes-Benz 722.9, VW / Audi DSG, VW / Audi CVT

Item #
9990



Air Powered Oil Removing & Filling Tool

- for easy and professional filling of transmissions
- also suitable for other non-corrosive liquids

adaptors for following transmissions:

- adaptor for Ford, 1/8" - 27NPT
- universal adaptor for e. g. BMW, Honda, Nissan etc.
- adaptor for VW, Audi
- adaptor for VW, Audi, Porsche
- adaptor for VW, Audi, MINI, M10 x 1.0
- adaptor for VW & Audi DSG, M24 x 1.5
- adaptor for VW & Audi CVT, M22 x 1.5
- adaptor for Mercedes-Benz 722.9, M12 x 1.0
- pressure gauge for monitoring the filling pressure
- 3 bar safety valve
- capacity: 6000 cm³
- air consumption 57 l/min
- air connection: 6.3 mm (1/4")



Item #
8775

Oil Filter Wrench | for VAG DSG | 24 mm

12.5  1/2

- for changing the DSG transmission oil filter
- disassembling or moving of the battery is not required with this tool
- reduces operating time to the minimum
- wrench size: 24 mm
- profile: 12-point



Item #
9334



Gear Oil Filling Hose for VAG

- is needed when replacing the DSG transmission oil
- with adaptor for 1 litre gear oil
- built-in valve prevents oil spillage



Item #
1402



Oil Funnel Adaptor Set | Plastic Type

- allows for fast oil filling without spillage
- ideal for many new vehicle models
- 2 litre funnel fits adaptors for wide application range
- colour-coded adaptors for oil filler hole
- special angled extension with swivel function for hard-to-reach places

adaptors for the following vehicles:

- bayonet adaptor for Audi, BMW, Dodge, Mercedes-Benz, Porsche, Volvo, VW
- threaded adaptor M42 x 4.5 for Subaru
- threaded adaptor M37 x 3.0 for Toyota, Lexus, Scion, Pontiac
- threaded adaptor M35 x 4.0 for Mazda
- threaded adaptor M32 x 3.5 for Dodge, Honda, Acura, Nissan, Jaguar, Ford
- bayonet adaptor for Toyota & Lexus 3.0 & 3.3l V6



Item #

8505-1

Oil Filling Adaptor for VAG | for BGS 8505-1, 8899

- new type of oil cover, suitable for oil funnel set BGS 8505-1 and BGS 8899

suitable for e.g. the following models (MQB):

- Audi A3, VW Golf 7, Seat Leon (5F), Skoda Octavia 3



Item #

8505-13P

Oil Funnel Adaptor Set | Aluminum Type

- helps to fill in engine oil spillage free
- tubing and adaptor are made of aluminum
- 1l funnel capacity

includes following adaptors:

- M37 x 3.0 for Lexus, Toyota (not for Prius / Yaris)
- M42 x 4.5 for Subaru (not for Tribeca)
- M32 x 3.5 for Nissan, Honda, Accura (not for MDX / RDX)
- M35 x 4.0 for most Mazda models
- bayonet adaptor for Audi, VW, BMW, Mercedes-Benz, Volvo, Dodge



Item #

8505

Oil Filling Set for Automatic Transmission

- for a clean filling of automatic transmission with gear oil
- suitable for transmissions which can be filled through the dipstick tube
- funnel with inspection window, Ø 125 mm, 211 mm long
- adaptor tube, 150° angled, for steep dipstick tubes
- filling tube adaptor for inclined dipstick tubes
- filling tube with a conical tip and rubber seal, tube diameter 16 mm, 430 mm length, for dipstick tube diameter 8 to 15 mm
- plastic hose, 200 mm length, Ø 13.5 x 16 mm



Item #
8898

Oil Funnel with Bayonet Adaptor for VAG, Mercedes-Benz, BMW, Porsche, Volvo

- allows for fast oil filling without spillage
- 2 liter funnel with attached bayonet adaptor

ideal for many models, such as e. g.

- Audi A3, A4, A5, A8, Q7, R8, RS4, RS6, S4, S6, S8
- BMW with bayonet cap
- Mercedes-Benz Sprinter 2.7l, 3.0l V6 CRD & models with bayonet caps
- Porsche Cayenne and Panamera
- Volvo 244, 245, 264, 265, 740, 760
- VW Beetle, CC, Cabrio, Eos, EuroVan, GTI, Golf, Jetta, Passat, Phaeton, R32, Rabbit, Touareg



Item #
8899

Universal Oil Funnel

- facilitates the oil filling process
- the funnel does not need to be held when re-filling oil
- thanks to automatically adjustable clamping mechanism, it can be used in many different ways
- clamping range: Ø 28 - 74 mm
- clamping mechanism can also be used for conventional funnels
- transparent funnel chamber indicates the oil flow
- suitable for e.g. following vehicle manufacturers: BMW, Mercedes-Benz, Ford, VW, Audi, Seat, Skoda, Renault, Peugeot, Citroen, Fiat, Mazda, Honda, Mitsubishi and many others



Item #
9391



Oil Filling Funnel | bent | Ø 145 mm

- double angled for hard to reach places
- drain diameter: approx. 20 mm
- height 320 mm
- funnel: Ø 145 mm

Item #
8695



Oil Funnel | 850 ml Reservoir

- square type
- neck external diameter: 27 mm
- neck internal diameter: 23 mm

Item #
9986



Magnetic Sockets for Oil Drain Screws | 15 pcs.

10 3/8

- facilitates the disassembly / assembly of oil drain plugs
- oil drain plugs will be held on the magnetic sockets
- magnetic sockets for drain plugs with internal hexagon: 8 - 10 - 12 - 13 - 14 - 17 mm
- magnetic sockets for drain plugs with internal square: 8 - 10 mm
- magnetic socket for drain plugs with T-Star: T45
- magnetic sockets for drain plugs with external hexagon: 13 - 14 - 17 - 18 - 19 - 21 mm
- surface finish: polished chrome metal

Item #
2256



Special Oil Drain Socket Set | 10 mm (3/8") | 21 pcs.

10 3/8

- 9 hexagon sockets 8 - 9 - 10 - 12 - 14 - 17 mm, 8 mm (5/16") - 10 mm (3/8") - 12.5 mm (1/2")
- 5 square sockets 8 - 11 - 12 - 13 - 14 mm, 8 mm (5/16") - 10 mm (3/8") - 12.5 mm (1/2")
- 1 inner square socket 10 mm
- 1 triangle socket 10 mm
- 1 spline socket M16
- 1 sliding T-bar, 200 mm
- surface finish: black burnished

Item #
1014



Universal Oil Drain Socket Set | 12 pcs.

10 \square $\frac{3}{8}$ "

- 7 sockets, 10 mm (3/8") drive, internal hexagon: 8 - 9 - 10 - 12 - 14 - 17 mm - 3/8"
- 4 sockets, 10 mm (3/8") drive, internal square: 8 - 11 - 13 mm - 3/8"
- 1 sliding bar



Item #
1017

Oil Service Tool Set | 6 pcs.

- used in combination with socket or 14 mm or 21 mm wrench
- oil service socket, hexagon 5/16" x 10 mm (3/8")
- oil service socket, square 8 x 10 mm (3/8")
- oil service socket, hexagon 8 x 10 mm
- oil service socket, square 11 mm x hexagon 12 mm
- oil service socket, square 13 mm x hexagon 14 mm
- oil service socket, hexagon 12.5 mm (1/2") x 17 mm



Item #
1015



Oil Service Socket Set | 12.5 mm (1/2") Drive | internal square | 6 pcs.

12.5 \square $\frac{1}{2}$ "

- on socket rail
- oil service sockets, 12.5 mm (1/2") drive, external square 8 - 10 - 12 - 14 mm, 1/2" - 3/8"
- surface finish: satin chrome plated



Item #
1016



Oil Drain Plug Socket | 4-pt. | 8 mm / 10 mm

12.5 \square $\frac{1}{2}$ "

- square 8 mm and 10 mm, reversible
- phosphated
- suitable e. g. for Ford, Nissan, Mazda, Renault, Peugeot, Volvo etc.
- 12.5 mm (1/2") drive
- surface finish: satin chrome plated



Item #
8991



Special Oil Drain Plug Wrench "8-IN-1"

- 4 square sockets 8 - 10 mm and 3/8" - 1/2"
- 4 hexagon sockets 8 - 12 - 14 - 17 mm
- length: 270 mm



Item #
1012



Special Oil Drain Plug Wrench | for Peugeot | 8 - 10 mm

- forged



Item #
1006



Oil Drain Plug Wrench for VAG

- for professional loosening and tightening of plastic drain plugs
- suitable for oil drain plugs in plastic oil pans, installed in:
 - Audi A1, A3, A4, A5, A6, A7, Q3, Q5, Q7, TT, TTS
 - Seat Alhambra, Leon, Toledo
 - Skoda Octavia, Rapid, Superb, Yeti
 - VW Beetle, Caddy, CC, Golf, Jetta, Passat, Polo, Scirocco, Sharan, Tiguan, Touran
- to be used as OEM T10549



Item #
9060



Oil Drain Plug Wrench for VAG

- for professional loosening and tightening of plastic oil drain plugs
- suitable for oil drain screws in plastic oil trays, installed in:
 - Audi A1, A3, A4, A5, A6, A7, Q3, Q5, Q7, TT, TTS
 - Seat Alhambra, Leon, Toledo
 - Skoda Octavia, Rapid, Superb, Yeti
 - VW Beetle, Caddy, CC, Golf, Jetta, Passat, Polo, Scirocco, Sharan, Tiguan, Touran
- drive: internal square 10 mm (3/8") and external hexagon 17
- to be used as OEM T10549



Item #
9424



Repair Kit for Oil Drain Threads | 114 pcs.

- 6 taps: M13 x 1.25 mm - M13 x 1.5 mm - M15 x 1.5 mm - M17 x 1.5 mm - M20 x 1.5 mm - M22 x 1.5 mm
- 6 oil drain plugs in the above-mentioned tap sizes
- 72 aluminium sealing rings: Ø 13 - 15 - 17 - 20 - 22 mm



Item #
123



Repair Kit for Oil Drain Threads | 64 pcs.

- 4 taps: M13 x 1.5 mm - M15 x 1.5 mm - M17 x 1.5 mm - M20 x 1.5 mm
- 5 oil drain plugs M13 x 1.5 mm, external hexagon drive 17 mm
- 5 oil drain plugs M15 x 1.5 mm, external hexagon drive 19 mm
- 5 oil drain plugs M17 x 1.5 mm, internal hexagon 8 mm
- 5 oil drain plugs M20 x 1.5 mm, internal hexagon 10 mm
- 10 aluminium sealing rings: Ø 13 - 15 - 17 - 20 mm



Item #	Description
126	Repair Kit for Oil Drain Threads 64 pcs.
126-BM13	Tap for BGS 126 M13 x 1.5
126-BM15	Tap for BGS 126 M15 x 1.5
126-BM17	Tap for BGS 126 M17 x 1.5
126-BM20	Tap for BGS 126 M20 x 1.5
126-SM13	Oil Drain Plug for BGS 126 M13 x 1.5 mm 5 pcs.
126-SM15	Oil Drain Plug for BGS 126 M15 x 1.5 mm 5 pcs.
126-SM17	Oil Drain Plug for BGS 126 M17 x 1.5 mm 5 pcs.
126-SM20	Oil Drain Plug for BGS 126 M20 x 1.5 mm 5 pcs.
126-UM13	Seal Ring Assortment for BGS 126 Ø 13 / 16.5 mm 10 pcs.
126-UM15	Seal Ring Assortment for BGS 126 Ø 15 / 18.5 mm 20 pcs.
126-UM17	Seal Ring Assortment for BGS 126 Ø 17 / 20.5 mm 20 pcs.
126-UM20	Seal Ring Assortment for BGS 126 Ø 20 / 23.5 mm 20 pcs.

Repair Kit for Oil Drain Thread | M14 x 1.25 mm

- 1 tap made from HSS-G steel
- 6 spare screws
- 12 copper sealing rings
- 6 aluminium sealing rings



Item #	Description
153	Repair Kit for Oil Drain Thread M11 x 1.5 mm
168	Repair Kit for Oil Drain Thread M13 x 1.25 mm
156	Repair Kit for Oil Drain Thread M13 x 1.5 mm
151	Repair Kit for Oil Drain Thread M14 x 1.25 mm
157	Repair Kit for Oil Drain Thread M15 x 1.5 mm
158	Repair Kit for Oil Drain Thread M17 x 1.5 mm
159	Repair Kit for Oil Drain Thread M20 x 1.5 mm

Oil Drain Plug Screws and Copper Seal Ring Assortment | 534 pcs.

- in plastic storage case
- oil drain plug screws: 5x10 mm - 5x12 mm - 5x13 mm - 5x14 mm - 5x15 mm - 3x16 mm - 3x18 mm - 3x20 mm
- copper O-rings: 50x6 mm - 50x8 mm - 50x10 mm - 50x12 mm - 50x13 mm - 50x14 mm - 50x15 mm - 50x16 mm - 50x18 mm - 50x20 mm



Item #
8118

Oil Drain Plug Screws and Aluminium Seal Ring Assortment | 534 pcs.

- in plastic storage case
- oil drain plug screws: 5x M10 - 5x M12 - 5x M13 - 5x M14 - 5x M15 - 3x M16 - 3x M18 - 3x M20
- sealing rings made of aluminium: 50x6 mm - 50x8 mm - 50x10 mm - 50x12 mm - 50x13 mm - 50x14 mm - 50x15 mm - 50x16 mm - 50x18 mm - 50x20 mm



Item #
8119



Oil Filter Strap Wrench | Ø 20 - 190 mm

- continuously adjustable
- strap width approx. 26 mm
- length of tool body approx. 255 mm
- heavy duty finish, tool weighs approx. 875 g
- suitable e. g. for oil filter assembly
- strap material similar to a V-belt
- length: 255 mm



Item #
1008

Oil Filter wrenches

- makes the loosening of stuck oil filters easier
- especially suitable for small spaces
- steel strip is tensed by turning the clamping screw at the end of the handle
- profiled steel strip prevents sliding over the filters



Item #	Description
8537	Oil Filter Strap Wrench Ø 65 - 105 mm
8537-1	Replacement Band 65 - 105 mm for BGS 8537
8536	Oil Filter Strap Wrench Ø 110 - 155 mm
8536-1	Replacement Band 110 - 155 mm for BGS 8536

Oil Filter Strap Wrench | Spring Steel Strap | Aluminium Die Cast

- suitable for all oil filters



Item #	Description
1027	Oil Filter Strap Wrench Spring Steel Strap Aluminium Die Cast Ø max. 155 mm
1025	Replacement Band for BGS 1027
1028	Oil Filter Strap Wrench Spring Steel Strap Aluminium Die Cast Ø max. 105 mm
1029	Replacement Band for BGS 1028



Oil Filter Strap Wrench | Ø max. 130 mm

- with reinforced, non-slip webbing
- all-purpose, easy to adjust
- for oil filters and other round fittings
- 2-component handle
- length of strap: 460 mm

Item #
1054



Oil Filter Strap Wrench XL | Ø 125 - 145 mm

12.5 1/2

- for especially large oil filter diameters of up to 145 mm
- high-strength steel strip for long service life
- also suitable for loosening granulate air dryer cartridges on trucks

Item #
8793



Oil Filter Chain Wrench | Ø 60 - 160 mm

- heavy duty tool with duplex chain
- chain width approx. 22 mm
- claw prevents slipping
- 180° swivel handle
- ease to use due to special chain-lock
- suitable for oil filter Ø 60-160 mm
- length: 520 mm
- surface finish: satin chrome plated

Item #
1011



Oil Filter Chain Wrench | Ø 60 - 115 mm

12.5  1/2

- with duplex chain
- chain width 13 mm
- also for rusted oil filters
- easy handling
- suitable for all filter cartridges with diameter 60 - 115 mm



Item #
1002



Oil Filter Chain Wrench | Ø 65 - 115 mm

12.5  1/2

- with robust 32 chain links
- 12.5 mm (1/2") drive



Item #
1033



Oil Filter Wrench Set | 30 pcs.

10 mm $\frac{3}{8}$ "

Item #
1039

CV



Oil service

Set Contents

Item #	Size	Steps	Groove	Planes	Example Applications
1039-66-6	66	1	6		Fiat Punto 1.2, Renault Clio 1.2, Rapid, Twingo
1047	65	1		14	Daihatsu, Toyota, Nissan, Fiat
1039-65-67	65-67	1		14	Daihatsu, Toyota, Nissan, Fiat
1039-68-14	68	1		14	Mazda, Ford, Subaru
1039-73-14	73	1		14	Toyota, Lexus
1039-74-15	74	1		15	Audi, Rover, Chrysler
1039-74-76	74-76	2		15	Ford, Opel, VW, Audi, Mercedes
1039-75-77	75-77	2		15	VW, Audi, Isuzu, Mercedes
1039-76-12	76	1		12	Fiat, Mercedes, Renault
1039-76-30	76	1	30		Ford
1039-76-8	76	1	8		Fiat, Lancia
1039-78-15	78	1		15	Nissan, Ford, Toyota
1039-80-15	80	1		15	Nissan, Honda, Opel, Mazda
1039-80-82	80-82	2		15	Subaru, Toyota, Honda, Nissan
1039-86-16	86	1		16	Volvo
1039-86-18	86	1		18	VW Golf, Audi A6 TDI, Peugeot, Citroen
1039-90-15	90	1		15	Honda, Mitsubishi, Isuzu
1039-92-10	92	1		10	Fiat
1039-93-15	93	1		15	Mazda, Volvo, Mitsubishi, Nissan, Honda
1039-93-36	93	1	36		Ford
1039-93-45	93	1	45		VW, Audi TDi
1039-95-15	95	1	15		Toyota, Alfa, Ford
1039-96-18	96	1	18		Audi A4, A6 TDI, VW Passat TDI, Renault Laguna
1039-106-15	106	1		15	Fiat Ducato
1039-108-15	108	1		15	Volvo
1039-108-18	108	1	18		Renault Espace, Laguna, Safrane, Traffic
1039-ADAPT	Adaptor 12,5 mm (1/2) x 10 mm (3/8)				
1039-SPINNE	Oil filter wrench				

Oil Filter Wrench Set | Ø 27 - 88.8 mm | 9 pcs.

10  3/8

- 10 mm (3/8") drive internal square
- end cap oil filter wrench 64.5 mm x 14-pt., aluminium chrome finish, for Toyota Auris, Corolla, Premio, Prius
- end cap oil filter wrench 64.5 mm x 14-pt., aluminium chrome finish, for Toyota V6 models from 2007 - 2008, Lexus ES 350, GS 350, GS 350h, LS 460, RX 350, LS 600j L
- end cap oil filter wrench 88.8 mm x 15-pt, aluminium chrome finish, for Kia and Hyundai
- End cap oil filter wrench 74.2 mm x 14-pt., aluminium chrome finish, for Audi, BMW, Ford, Mazda, Toyota, Volkswagen, Porsche, Mercedes-Benz V6, V8
- end cap oil filter wrench 86.6 mm x 6-pt., aluminium chrome finish, for BMW 335i, 535i, 3 series E90, X6 3.0L, Volvo models 1999 - 2006 (not 2005 40 and 50 models)
- universal end cap oil filter wrench 63 - 83 mm, SCM 440 chrome finish
- end cap oil filter wrench 27 mm x 6-pt., S45C nickel plated, for Mercedes-Benz and Smart models
- end cap oil filter wrench 32 mm x 6-pt., S45C nickel plated: for Opel 4-cylinder 2.2 X10XE, X12XE, Y17DT, Y17DT, Mercedes-Benz OM 364, OM 366
- end cap oil filter wrench 36 mm x 6-pt., S45C nickel plated: for Mercedes-Benz Diesel OM604, OM605, OM606, BMW M52, M60, M70, MINI, VW VR6



Item #
8667

Oil Filter Wrench Set | for Renault dCI Motoren | 3 pcs.

- suitable for Renault 1.5 L, 1.9 L, 2.2 L, 2.5 dCI engines
- also suitable for identical engines in Nissan, Opel and Dacia
- 27 mm 12-point cap also fits for Mercedes-Benz A-Class
- 96 mm 18-point cap also fits Audi A4, A6 TDI and VW Passat TDI



Item #
1009

Oil Filter Wrench Set | Ø 27 / 32 / 36 mm | 3 pcs.

10  3/8

- height 35 mm
- oil filter cap wrench 27 mm x hexagon, for Mercedes-Benz, Smart, Cadillac CTS, SI 2.8L, 3.2L and 3.6LSRX, Buick rendezvous Ultra, Buick LaCrosse CXS, Stum L3000, Saab 9-5
- oil filter cap wrench 32 mm x hexagon, for Mercedes-Benz, Opel, Astra, Corsa, Zafira
- oil filter cap wrench 36 mm x hexagon, for Opel Omega DL 16V, Vectra, Zafira 98, BMW 16V, Ford Mondeo 16V Duratorq Transit 2.5 and 2.0 Duratorq Diesel, Mercedes-Benz 116MB, Vito

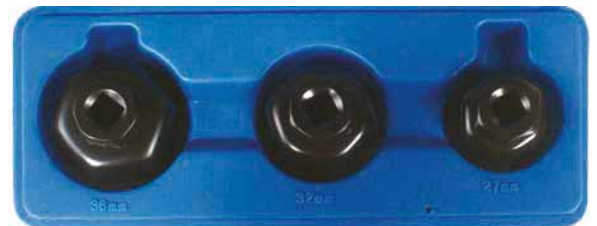

Item #
1037

Oil Filter Wrench Set | Ø 24 - 38 mm | 7 pcs.

10  3/8

- low profile design perfect for use on cartridge style filters
- oil filter cap wrench 24 mm, misc. BMW
- oil filter cap wrench 27 mm for Mercedes-Benz A class
- oil filter cap wrench 32 mm for Opel Astra G, Corsa B, Zafira
- oil filter cap wrench 36 mm for misc. BMW, Ford Mondeo 2.0, Transit 2.0, D, Opel Vectra B, Zafira, misc. Mercedes-Benz
- oil filter cap wrench 38 mm for Opel Vectra 2.0D
- oil filter cap wrench 29 mm for misc. models
- oil filter cap wrench 30 mm for misc. models



Item #	Description
8377	Oil Filter Wrench Set Ø 24 - 38 mm 7 pcs.
8377-27	Oil Filter Wrench Ø 27 mm for Mercedes-Benz
8377-36	Oil Filter Wrench 6-point Ø 36 mm

Oil Filter Wrench | 6-point | for Ø 36 mm | for Audi, BMW, Ford, MAN, Mercedes-Benz, Opel, VW 12.5 1/2

- suitable for the following models:
 - Opel Astra, Corsa 1.9 I CDTi
 - Ford Mondeo, Transit 2.5 and 2.0 (Duratorq)
 - Mercedes-Benz Vito
 - VW Passat, Polo 1.2 I petrol as of 2005
 - VW Transporter T5 1.9 I diesel as of 2004, Touran TDi
 - Audi A6 3.2 I TSI, V6 as of 04
 - BMW- and MAN-engines



Item #	
8821	

Oil Filter Wrench Set | Ø 65 - 75 mm | 4 pcs.

12.5  1/2

- oil filter cap wrench, aluminium: 65 mm x 14-pt
- oil filter cap wrench, aluminium: 67 mm x 14-pt
- oil filter cap wrench, aluminium: 74 mm x 14-pt
- oil filter cap wrench, aluminium: 75 mm x 15-pt



Item #	
8384	

Oil Filter Wrench | Die-Cast Aluminum

12.5  1/2

- BGS 1041: for VW, Mercedes-Benz, BMW, Audi, Opel
- BGS 1042: for Toyota, Nissan, Fiat, Daihatsu
- BGS 1045: for GM, Chrysler



Item #	Description
1042	Oil Filter Wrench 14-point Ø 64 mm for Daihatsu, Fiat, Nissan, Toyota
1041	Oil Filter Wrench 14-point Ø 74 mm for Audi, BMW, Mercedes-Benz, Opel, VW
1045	Oil Filter Wrench 15-point Ø 75 mm for Chrysler, GM



Oil Filter Wrench | Sheet Steel

10  3/8

- BGS 1007: for Mercedes-Benz
- BGS 1036: for Toyota Diesel
- BGS 1046: for VW, Porsche, Mercedes-Benz, BMW, Audi, Opel
- BGS 1047: for Daihatsu, Toyota, Nissan, Fiat

Item #	Description
1047	Oil Filter Wrench 14-point Ø 65 mm for Daihatsu, Fiat, Nissan, Toyota
1046	Oil Filter Wrench 14-point Ø 76 mm for VW, Porsche, Mercedes-Benz, BMW, Audi, Opel
1007	Oil Filter Wrench 14-point Ø 84 mm for Mercedes-Benz
1036	Oil Filter Wrench 15-point Ø 99 mm for Toyota



Oil Filter Wrench | 14-point | Ø 64.5 mm | for Lexus, Toyota

10  3/8

- suitable for the following models:
 - Toyota 2007 - 2008 3.5l V6
 - Lexus LS600H (2006)
 - Lexus IS250 (since 2006)
 - Lexus ES350 (since 2007)
 - Lexus GS350 (since 2007)
 - Lexus GS450H (since 2007)
 - Lexus LS460 (since 2007)
 - Lexus RX350 (since 2007)
 - Lexus LS600H (2008)
- profile: external 14-point
- material: aluminium
- surface finish: lacquered
- diameter: 64.5 mm



Item #
8761

Oil Filter Wrench | 15-point | Ø 76 mm | for Ford

10  3/8

- suitable for Ford oil filter EM5G-6714-AA (1 883 037)
- drive 10 mm (3/8")
- profile: external 15-point
- diameter: 76 mm



Item #
9077



Oil Filter Wrench | 15-point | Ø 90.2 mm | for Land Rover

- profile: external 15-point
- material: die-cast aluminium
- diameter: 90.2 mm

Item #
9269



Oil Filter Wrench | 18-point | Ø 96 mm | for Renault DCI

10 3/8

- suitable for the following Renault models: Espace, Laguna, Master, Traffic, Vel Satis, Avantime with 2.0 / 2.2 / 2.5L DCI engines
- drive: 10 mm (3/8")
- material: die-cast aluminium

Item #
9163



Oil Filter Wrench | 15-point | for Hyundai, Kia

10 3/8

- 15-pt.
- 10 mm (3/8") drive
- aluminium
- suitable for KIA Mohave and Hyundai Veracruz engines

Item #
997



Oil Filter Wrench | 14-point | for Jeep, Mercedes-Benz

10 3/8

- suitable for Mercedes-Benz E320, Sprinter and Jeep Cherokee 3.0L V6 diesel since 2007 - made of aluminium
- profile: external 14-point

Item #
1053



Oil Filter Wrench | 14-point | Ø 65 mm | for Toyota

10  3/8

- suitable for Toyota 1.8 & 2.0l 4 cylinder engines, installed in Toyota Auris, Corolla, Premio and Prius
- 10 mm (3/8") drive
- aluminium

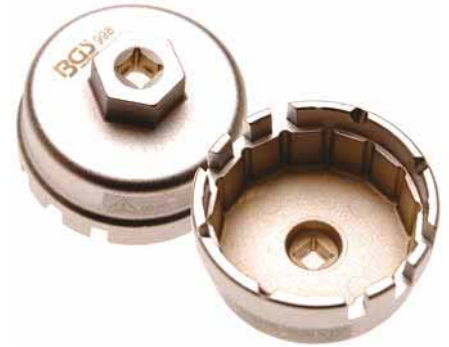

Item #
998

Oil Filter Wrench | 14-point | Ø 84 mm | for Dodge, Jeep, Mercedes-Benz

- depth: 48 mm
- 12.5 mm (1/2") drive
- suitable for the following models:
 - Mercedes-Benz Sprinter (2007)
 - Mercedes-Benz E320 (2007)
 - Dodge Sprinter (2007)
 - Jeep Cherokee 3.0 V6 Diesel (2007)



Item #
8765

Oil Filter Wrench | 14-point | Ø 102 mm | for Opel

12.5  1/2

- 12.5 mm (1/2") drive



Item #
8859

Oil Filter Wrench | for VAG Diesel with MANN/Mahle Filter

12.5  1/2

- for quick installing and removing of oil filters

suitable for following VAG oil and Diesel filters:

- MANN filter W920, W920/7, W930, W930/9, W940, W940/15, W940/20, W940/25, W950, W950/1, W950/5, W962/2, W962/7, WW962/14, W1130/1, WK940/5, WK940/4, WK950/4, WK962/5, WP931, WP962/3,
- as well as Knecht and Mahle oil filters: OC51, OC83, OC214



Item #
9201



Oil Filter Wrench Set | 5 pcs.

10  3/8

- for loosening of oil filter housing
- especially suitable for use in confined spaces
- suitable for use with ratchet
- 10 mm (3/8") drive
- on socket rail
- oil filter wrench 24 mm: for BMW N62, model 5 / 7
- oil filter wrench 27 mm: for MINI, Renault 1.5 / 1.9 / 2.2 / 2.5 DCI, Ford Fiesta 1.4 / 1.6 TDCi, Mercedes-Benz A-class, Ford Transit 2.2 / 2.4 / 3.2 as of 2006
- oil filter wrench 32 mm: for Ford Transit 2.0 / 2.4, 2000 - 2006, Volkswagen Polo 1.2, Transporter T5 1.9 as of 2004, Audi A6 3.2 V6 TSI as of 2004, Opel Astra G, Corsa B
- oil filter wrench 36 mm: for Mercedes-Benz Transporter M616, 116/100 Transporter, Mercedes-Benz 220D, E220D, M604, C250D, E250D, M605, E300D, M606 BMW M52 (3/5 series), M60 (5/7/8 series), M73 (7/8 series), Opel Vectra-B di 16V as of 1998, Volkswagen Transporter T5, Lupo 1.2 TDi, Toureg TDi
- oil filter wrench 38 mm: for Opel Astra, Zafira 2.0 / 2.2 dti



Item #
8677

Special Ratchet Ring Spanner for Oil Filter change | for PSA, Ford 2.0, 2.2 TDCI, HDI 12.5 1/2

- size: 27 mm, with adjustable head
- 12.5 mm (1/2") drive

suitable for loosening / fastening of oil filter housing on e.g. following models:

- Ford 2.0 TDCi (DW10C) as of 2010
- Ford 2.2 TDCi (DW12C) as of 2010
- Citroen / Peugeot 2.2 HDI (DW12C) as of 2010
- Citroen / Peugeot 2.0 HDI (DW10C) as of 2009
- Jaguar XF 2.2D as of 2012

- to be used as OEM 303-1579



Item #
8979

Oil Filter Wrench | 12-point | Ø 27 mm | for Ford, PSA

- 12-point model with 12.5 mm (1/2") drive
- suitable for the following models:
 - Ford Duratorq 2.0 / 2.2 TDCI with engine codes DW10C and DW12C
 - PSA 2.0 and 2.2 HDI, e.g. in S-Max, Mondeo, Galaxy car models



Item #
1044

Oil Filter Wrench | 12-point | for Haldex coupling on VW All-Wheel Drive | 46 mm

- 12-point 46 mm
- suitable for VW 4-wheel manual transmission

Item #
1048



Oil Filter Wrench | 12-point | for Renault | 76 mm

- for Renault EF34 oil filters 76 mm 12-point
- stuck oil filters can be easily loosened due to extra long handle
- suitable for the following models:
 - Renault Twingo R5, Rapid sedan with C, Clio, Kangoo petrol-R12 Espace III, Laguna sedan with F petrol engines, Megan Kangoo with K petrol engines, R21 Espace I + III F petrol engines and Traffic with J petrol engines
 - Ford Diesel 1.8 Motorcraft filter and EFL344
 - Peugeot with Purflux Filter

Item #
8259



Oil Service Wrench | for Audi A4 / A6, BMW

- hexagon 19 mm x M16 spline with central bore
- length: 240 mm
- surface finish: satin chrome plated

Item #
8727



Oil Service Wrench | 17 mm x H14

- hexagon 17 mm ring wrench with 14 mm internal hexagon bit, slightly angled
- length 235 mm
- surface finish: satin chrome plated

Item #
8728



Oil Drain Adaptor Hose for Oil Filter Cartridges | for Toyota, Lexus

- suitable for Toyota and Lexus
- prevents oil contamination when replacing filter cartridges
- by mounting the hose on the oil filter housing lid, emptying of the oil filter housing prior to changing the filter is possible

Item #
1401



Oil Filter Drain Hose for Oil Filter Cartridges | for VAG 1.8, 2.0 petrol

- opens a valve when screwing in the oil filter housing
- allows a controlled and clean oil discharge from the oil filter housing

suitable for:

- VAG 1.8 and 2.0L petrol engines with engine codes AXW - BLX - BLR - BLY - BVX - BVY - BVZ
- Audi A3 / A4 / A6 / TT
- VW Golf V Passat / Touran / New Beetle / EOS / Jetta III
- Seat Altea / Leon / Octavia / Toledo

Item #
9000



Universal Oil Filter Wrenches | 12.5 mm (1/2") Drive

12.5 1/2

- universal, can be used for many filters
- spring loaded, self contracting

Item #	Description
8395	Universal Oil Filter Wrench 12.5 mm (1/2") Drive Ø 60 - 80 mm
8396	Universal Oil Filter Wrench 12.5 mm (1/2") Drive Ø 80 - 98 mm
8390	Universal Oil Filter Wrench 12.5 mm (1/2") Drive Ø 110 - 140 mm



Oil Filter Wrench, 3-arm | for Oil Filter Ø 50 - 100 mm

12.5 1/2

- surface finish: chrome plated

Item #
1031



Oil Filter Wrench, 3-arm | for Oil Filter Ø 69 - 135 mm

10  3/8

- for filters with a diameter between 69 - 135 mm
- incl. adaptor 12.5 mm (1/2") to 10 mm (3/8"), with 21 mm outside hexagon



Item #
1030



Air Filter Wrench, 3-arm | for Oil Filter Ø 95 - 150 mm

12.5  1/2

- for loosening granulate air dryer cartridges in trucks



Item #
1032

Oil Filter Wrench, 3-arm | for Oil Filter Ø 115 - 160 mm

12.5  1/2

- for oil- and air filters
- right and left handed, for tightening and loosening
- for cartridges Ø of approx. 115 - 160 mm
- 60 mm arm length
- extra heavy duty design, 1325 g



Item #
1049

Oil Filter Removal Tool

- for disassembly of oil filters 55 - 95 mm
- oil filter wrench with square and hexagon drive
- handwheel for loosening and tightening
- replaceable legs in different lengths
- 150 Nm capacity for stuck filters



Item #
8596

Locking Pliers for Oil Filters | Ø 53 - 115 mm | 230 mm

- forged
- length: 230 mm
- surface finish: nickel plated
- max. clamping width: 115 mm
- min. clamping width: 53 mm

Item #
1038



Special Oil and Fuel Filter Pliers with swivel Jaws

- jaws can be inclined up to 90° in both directions for easy removal of oil and fuel filters
- ideal for loosening filters in hard-to-reach areas that can not be loosened with common oil filter pliers
- jaws adjustable in 4 positions every 45° to achieve a larger area of application
- two-stage pliers opening makes a large working range possible: 57 mm to 120 mm
- slipping around of the filters is avoided by 6 heavy claws on each jaw

Item #
8271



Oil Filter Pliers | self-adjusting | Ø 60 - 120 mm

- adapts automatically to the oil filter
- suitable for oil filter diameters from 60 to 120 mm
- PVC dipped handles
- length: 300 mm

Item #
8902



Oil Dipstick Set | for Mercedes-Benz

- 4 dipsticks for measuring the oil of the engine and the transmission
- absolutely necessary after changing the oil, because vehicles are delivered without oil gauges
- suitable for the following engines
 - 1010-A (length: 1220 mm): for transmission oil, transmission type 722.6
 - 1010-B (length: 920 mm): for transmission oil, transmission type 722.7, 716.5
 - 1010-C (length: 930 mm): for engine oil, engine codes: 103.943/984/985, 104, 111, 119, 120, 137, 603.913/963/97, 604, 605, 606, 611, 612, 613, 628, 612.965
 - 1010-D (length: 930 mm): for engine oil, engine codes M112, 113, 646, 647, 648



Item #	Description
1010	Oil Dipsticks Set for Mercedes-Benz 4 pcs.
1010-A	Transmission Oil Dipstick for Mercedes-Benz transmission Type 722.6
1010-B	Transmission Oil Dipstick for Mercedes-Benz transmission Type 722.7, 716.5
1010-C	Engine Oil Dipstick for Mercedes-Benz M137, 611, 612, 613
1010-D	Engine Oil Dipstick for Mercedes-Benz M112, M113, M646, M647, M648



Oil service

Oil Dipstick | for Audi and VW with Oil Level Indicator

- suitable for Audi and VW models with oil level indicator in the display
- an unnoticed defect of the display without manual oil level check could cause engine failure
- useful tool after exchange of the oil sensor or to calibrate the driver's display
- fits the following engines: 3.0 and 2.7 L TDI - 2.0 TDI - 1.8 and 2.0 TFSI - 3.0 and 3.2 TFSI
- setting table for measuring stick included
- to be used as OEM T40178

Item #
1052



Transmission Oil Dip Stick for Audi A6

- suitable for the following Audi A6 / 100 models (without dipstick):
 - 4A, C4 (12.1990 - 07.1994)
 - 44, 44Q, C3 (08.1982 - 11.1990)
 - 43, C2 (06.1976 - 07.1982)
 - C1 (01.1970 - 12.1976)

Item #
8517



Engine / Transmission Oil Dipstick for MINI Cooper S R53 and R52

- for gearbox and engine oil level measurement
- corrosion-resistant coated dipstick
- dipstick length: 570 mm
- length: 625 mm



Item #
8967



Oil Suction Pump | 12 Volt

- max. flow rate for engine oil approx. 0.2 l / min (at 40 ° C oil temperature)
- ideal equipment for quick and clean oil changes
- the oil pump works by connecting the clamps to the 12-V car battery
- can remove 100% of the used oil if inserted through the dipstick opening with a diameter of 6 mm
- complete with all necessary accessories
- max. suction height 70 cm
- not suitable for fuel and other easy flammable fluids



Item #
9910



Oil Suction Pump | volume 200 cm³

- for suction of small amounts of gear and clutch oil

Item #
4065



Oil Barrel Pump with Lever

- for pumping liquids from barrels
- suitable for oil, antifreeze, etc. (not for fuel)
- for barrels up to 200 liters
- self-adjusting telescopic suction tube
- pumps about 300 ml per stroke
- with 2 "NPT thread



Item #
8343

Rotary Drum Pump

- with standard barrel adaptor
- variable depth of immersion up to 100 cm
- 26 mm outlet pipe
- suitable for oil and other non-corrosive liquids
- output: max. 278 cm³ per crank rotation



Item #
8345

Air Pressure Pump for Oil Barrels

- for easy extraction of oil from barrels
- suitable for barrels up to 200 l
- simple and easy to operate
- for all non-corrosive liquids
- air inlet: 6.3 mm (1/4")
- recommended air hose Ø 9.5 mm
- operating pressure: 2 - 7 bar
- extraction hose: Ø 12.7 mm
- flow rate 2 - 11 l/min
- oil viscosity: 0 - 120
- not suitable for fuel and other easy flammable fluids



Item #
9210

Lever Pump for Plastic Barrels

- for transferring liquids from plastic barrels with screw connection, 56.5 - 58.5 mm
- suitable for oil, coolant, etc.
- oil-resistant flexible hose
- with non-drip nozzle and a drain back nozzle holder
- self-priming down-stroke style pump
- flow capacity: 0.06 l/stroke
- max. medium temperature 60 °C
- suction pipe length: 325 mm
- hose length: 1.27 m



Item #
8754

Digital Battery Load Tester

- for testing vehicle batteries, charger and starter systems
- suitable for 12-V batteries with cold start current from 200 to 1000 A
- 3-digit digital voltage display
- battery condition is shown via 3 LEDs
- load current: 125 A
- test cable length: 480 mm
- length: 290 mm
- width: 170 mm
- height: 90 mm
- weight: 1.2 kg

Item #
63502



Digital Battery Load Tester

- big 3-digit LED-Digital-display
- quick indicator (3 LED lights) for battery power status
- fixed current load - 100 Amps
- max. capacity of battery to be tested 200 Ah / 1,000 CCA
- battery voltage: 12 V

Item #
63500



Car Battery Charger | 12 V

- for 12-V batteries (cars / motorcycles / boats)
- used for charging lead acid batteries 1.2 Ah to 120 Ah
- overload, short circuit and wrong polarity protection
- fully automatic charging and protection against sulphate collection
- prolonged connection possible for continued charging and battery maintenance
- CPU-controlled
- input voltage: 220 - 240 V / 50 - 60Hz
- rated output voltage: 12 V / 3.6 - 4.0 A
- charging voltage: 14.4 V / 0.8 A (mode 1) - 14.4 V / 3.6 A (mode 2) - 14.7 V / 3.6 A (mode 3)
- charging current: 3.6 A

Item #
63505



Battery and charger system tester

- for fault diagnosis of 12-V battery and charging systems
- easy to use, just connect and check indicator lights
- LEDs are electronically controlled
- 3 LEDs for battery test: LED red = battery empty or defective / LED yellow = battery OK / LED green = battery very good
- 3 more LEDs for alternator test: LED green = charging system OK / LED yellow = charging system OK (maximum charging voltage) / LED red = charging system is not OK (it may damage the battery and other parts of the electric system)



Item #
2189



Battery Filler | 2 litres

- for filling batteries
- suitable for distilled water
- outlet with adjustable flow
- automatic stop prevents overfilling of batteries



Item #
9926

Battery Filler

- for suction and filling of liquids
- particularly suitable when charging batteries



Item #
9989



Round Battery Terminal Set

- round cable holder with 2 clamping screws
- includes 1 plus and 1 negative pole terminal
- material: brass



Item #
1408



Car Battery Disconnect Adaptor | flat

- for disconnecting the battery when not used for a prolonged time period
 - can also be used to prevent theft of a car
- suitable for batteries with flat terminals
- max. current: 250 A

Item #
1416



Car Battery Disconnect Adaptor

- for disconnecting the battery when not used for a prolonged period, can also be used to prevent theft of a car
- electrical isolation of the negative battery pole
- suitable for batteries with round terminals
- max. current: 250 A

Item #
1414



Car Battery Disconnect Adaptor | angled

- for disconnecting the battery when not used for a prolonged time period, can also be used to prevent theft of a car
- electrical isolation of the negative battery pole
- suitable for batteries with round terminals
- max. current: 250 A

Item #
1415

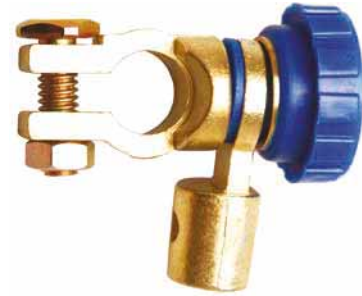

Emergency Battery Switch | 300 A

- for separating the battery from the electrical system
- is used in motor sports, construction machines etc.
- prevents battery drain
- 2 mounting holes
- protective cap prevent entry of moisture
- incl. 2 keys with hole for operating cable

Item #
80756



Brake Fluid Tester

- 4 LED display for showing the condition of the brake fluid
- suitable for brake fluids DOT3, DOT4, DOT5.1
- not suitable for brake fluid DOT5
- warning if battery is empty
- 9-V monoblock battery



Item #
63525



Brake Fluid Tester

- for safe testing of brake fluids
- 6 LEDs for brake fluid condition indication
- suitable for the following brake fluids: DOT 3, DOT 4, DOT 5.1, Pennzoil DOT 3, Motorcraft DOT 3, AC Delco DOT 3, Prestone DOT 3, Toyota DOT 3
- with LED lighting
- battery: 1.5 V AAA (included)



Item #
67242



Brake Fluid Tester

- high accuracy and reliability
- test results are displayed on 4 LEDs
- with protective cap to protect the sensors
- works on a 1.5 V AAA battery (included)
- easy to use, switch on, insert sensors into the brake fluid, read result
- suitable for brake fluids DOT3, DOT4, DOT5.1
- not suitable for brake fluid DOT5
- diameter: approx. 20 mm
- length: 150 mm

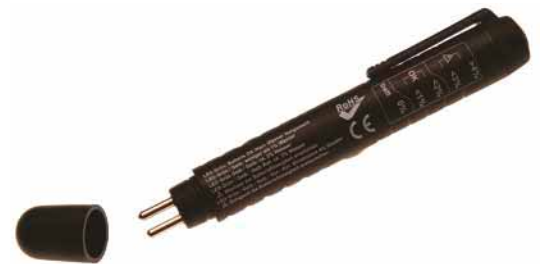

Item #
67241



Electronic Brake Fluid Tester

- determines the percentage of water in the brake fluid quickly and easily
- immediate indication of the test results via diodes:
 - green =< 1.5 % water
 - yellow 1.5 - 3 % water
 - red > 3 % Wassergehalt
- suitable for brake fluids DOT3, DOT4, DOT5.1
- non-compatible with brake fluid DOT5
- with automatic power off
- incl. battery



Item #
67240



Gas Detector

- detects methane, isobutane and propane gas
- easily pinpoints gas leaks
- calibrates automatically when power is on
- auto power off to save battery life
- LED chain in five levels to indicate the gas concentration
- over 440 mm long flexible probe for measuring gas concentrations
- built in earphone jack
- mute function (device OFF)
- probe: semiconductor
- response time: under 10 seconds
- warm up time: max. 60 seconds
- operating temperature: -5°C to 45°C
- measuring range: methane 120 - 1920 ppm / propane 40 - 640 ppm
- also suitable for car LPG gas



Item #
2198



Forming Gas Leak Detector

- for leakage testing of air conditioners that have been filled for test purposes with forming gas (forming gas = mixture of 5% Hydrogen H₂ + 95% Nitrogen N)
- allows quick and reliable leakage detection
- microprocessor control with advanced digital signal processing
- tricolor LED bar indicator
- adjustable sensitivity
- low battery indication
- semiconductor gas sensor
- flexible stainless probe, length: 40 cm
- automatic zeroing and compensating of ambient concentration
- sensitivity: less than 5 ppm
- alarm method: buzzer, LED bar
- battery life: approx. 7 hours (normal use)
- automatic power off
- dimensions: 173 x 66 x 56 mm
- weight approx. 400 g
- warm-up time: approx. 45 sec.
- operating temperature: 0 - 40°C
- 4 pcs. batteries (AA), user manual, carry case



Item #
3401



Air Condition Pressure Gauge

- includes high- and low pressure hose and connection hose for service devices
- gauges are protected in an aluminum housing
- shut-off valves for high and low pressure
- if the quick couplings are not used on air pressure hoses, they can be attached to the side blind connectors for protection
- with hooks
- hose length 1.5 m
- suitable for R12 und R134A
- scale value on low pressure dial gauge: 0 to 350 PSI (vacuum: 10 to 30 in Hg) (-40°C to +37°C)
- scale value on high pressure dial gauge: 0 to 500 PSI (0°F to 190°F) (-10°C to + 88°C)
- ideal replacement item for defective gauges on service devices, can also be used for diagnosis without service devices



Item #
8425

Air Condition Leakage Tester

- for easier leak detection on cars, trucks, and other air conditioners
- suitable for refrigerants: R134a, R12, R11, R500, R503, R22, R123, R124, R502, R404a, R125, AZ-50, HP62, MP39
- visual and audible signal upon detection of a leak
- adjustable sensitivity
- working mode: continuous and no limit
- short reaction time
- size: 22.9 x 6.5 x 6.5 cm
- weight: 560 g
- power requirement: 3 V DV (2 x 1.5 V)
- special length: 355 mm



Item #	Description
8557	Air Condition Leakage Tester
8557-1	Spare Probe for BGS 8557

Coating Thickness Gauge

- digital display with backlight
 - one-hand operation
 - measuring range: 0 - 40 mils / 0 - 1000 μm
 - resolution: 0.1 mils / 0.1 μm
 - accuracy: +/- 4 dgts (0 - 7,8 mils) +/- 7 dgts (0 - 199 μm)
 - response time: 1 sec
 - auto hold function
 - automatic power off
 - delivered with bag, battery, calibration pad & manual
- BGS 2193, measures the thickness of the paint layer on all surfaces of ferrous metals (e. g. sheet steel)
 - BGS 2197, measures the thickness of the paint layer on all surfaces made of ferrous and non-ferrous metals (e. g. aluminum, steel, copper, brass, etc.)



Item #	Description
2193	Coating Thickness Gauge for Iron Metals
2197	Coating Thickness Gauge for Iron and Non-Iron Metals

Coating Thickness Gauge

- allows measurements of paint and plastic coating thickness on metal surfaces
- ideal for the vehicle trade, improper bodywork repairs can be quickly found without much effort
- output via 3-colour LEDs: red LED: paint thickness is greater than 1.8 mm, yellow LED: paint thickness is between 1.0 to 1.8 mm, green LED: paint thickness is less than 1.0 mm
- comparison measurements are possible on a reference base
- measuring head protected by a removable cap
- length: 68 mm
- width: 40 mm
- weight: 50 g



Item #
63535



Carbon Dioxide Leak Tester for Engines

- incl. contrast agent
- can be combined with cooler adaptor and vacuum pump BGS 8027-1 and BGS 8098-1



Item #	Description
8037	Carbon Dioxide Leak Tester for Engines
8037-1	Contrast Agent for BGS 8037

Ultrasonic Leak Detector for Gas, Air, Water Tanks

- for a reliable detection of leaks in closed, pressurized and non-pressurized pressure and vacuum tanks
- consisting of ultrasonic transmitter, receiver and headphones
- with visual and audible indication
- frequency response: 40 kHz \pm 2 kHz
- temperature range 0 °C to 40 °C
- relative humidity: max. 80%
- battery: 9 V, 6F22 or equivalent
- size 192 x 50 x 30mm
- weight: about 115 g (including battery)



Item #
63524



Oil Pressure Test Kit

- helps to locate faults in the oil pump system
- scale measuring 0 – 10 bar (tolerance \pm 5 %)
- with many adaptors:
 - R 1/8" DIN 2999 - 1/8"x27 NPT - 1/4"x18 NPT - 3/8"x20 UNF - 1/2"x20 UNF
 - M10x1.0 - M12x1.5 - M14x1.5 - M16x1.5 - M18x1.5 - 90°



Item #
8007

Fuel Pressure Gauge | 0 - 8 bar

- all purpose set with precision manometer (0.03 - 8 bar) (tolerance \pm 2 %)
- for mechanic and electronic fuel injection systems
- 30 adaptors make this set suitable for nearly all european, asian and american car brands, such as: Mercedes-Benz, BMW, Audi, Honda, Mazda, Renault, Peugeot etc.
- can be used for nearly all injection systems, e. g.: K-Jetronic, L/LH-Jetronic, Motronic, Motronic-Jetronic MPFI, TBI, EFI, DIGIFANT 1/2, CIS-Digital, Weber CFI Spi, Singlepoint, Multipoint
- easy checking of leak tightness, system and control pressure due to 3-way valve
- incl. 5 hoses, each with coupling on both sides



Item #	Description
8026	Fuel Pressure Gauge 0 - 8 bar
8026-1	Gauge with Connectors for BGS 8026

Compression Tester for Diesel Engines

- included various adaptors (for glowplugs and injector nozzles) make this kit useful for many car types
- suitable for nearly all brands, such as: BMW, Mercedes-Benz, Ford, VW, Toyota, Renault, Volvo, Mazda, PSA, Opel, Nissan, Vauxhall
- 1 manometer 0 - 70 bar, accuracy +/- 5 %
- 1 angled adaptor
- 5 glow plug adaptors:
 - M10 x 1.25 mm, 114.5 mm long
 - M10 x 1.0 mm, 119 mm long
 - M10 x 1.25 mm, 73.5 mm long
 - M12 x 1.25 mm, 54 mm long
 - M14 x 1.25 mm, 72 mm long
- 3 injector adaptors:
 - M20 x 1.5 mm, 78 mm long
 - M24 x 2.0 mm, 65 mm long
 - Ø 21 mm, 114 mm long
- 1 stanadyn injector adaptor: Ø 19 mm, 112 mm long

Item #	Description
8008	Compression Tester for Diesel Engines
8008-1	Pressure Meter for BGS 8008
8008-2	Adaptor for BGS 8008 for Bosch M10 x 1.0 mm
8008-M10K	Adaptor for BGS 8008 short M10 x 1
8008-M10X1.0	Adaptor for BGS 8008 M10 x 1
8008-35	Compression / Pressure Loss Adapter for Ford, PSA, Jaguar, Mazda
8008-52	Compression / Pressure Loss Adapter for Citroen, Jaguar, Peugeot, Volvo
8008-55	Compression / Pressure Loss Adapter for Mercedes-Benz
8008-56	Compression / Pressure Loss Adapter for Smart
8008-69	Compression / Pressure Loss Adapter for PSA
8008-70	Compression / Pressure Loss Adapter for VAG
8008-72	Compression / Pressure Loss Adapter for FIAT Ducato

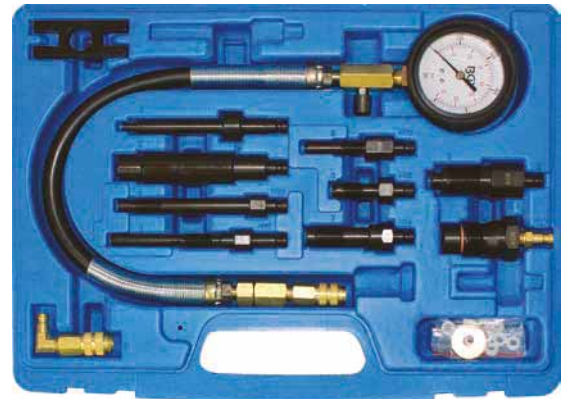

Test Devices

Compression Tester for Petrol and Diesel engines

- compression pressure testing up to 50 bar (725 psi) possible
- quick coupling in straight or angled version
- glow plug adaptors for the following brands: Alfa, BMW, Chrysler, Daewoo, Fiat, Ford, Hyundai, Isuzu, Land Rover, Mazda, Mercedes-Benz, Mitsubishi, Nissan, Opel, PSA, Renault, Saab, Suzuki, Toyota, VAG, Vauxhall and Volvo
- injector adaptors M20, M22, M24 and Stanadyne injectors for Ford
- spark plug adaptors M10, M12, M14 and M18
- suitable for most cars, trucks, buses, agricultural and marine engines

Item #
8400



Petrol & Diesel Engine Compression and Leakage Test Kit

- suitable for most petrol and modern HDi, TDCi, pump injector and older diesel engines
- compression pressure testing up to 50 bar (725 psi) possible
- quick coupling in straight or angled version
- all gauges with rubber protection
- glow plug adaptors for the following brands: Alfa, BMW, Chrysler, Daewoo, Fiat, Ford, Hyundai, Izusu, Land Rover, Mazda, Mercedes-Benz, Mitsubishi, Nissan, Opel, PSA, Renault, Saab, Suzuki, Toyota, VAG, Vauxhall and Volvo
- injector adaptors M20, M22, M24 and Stanadyne injectors for Ford
- spark plug adaptors M10, M12, M14 and M18
- suitable for most cars, trucks, buses, agricultural and marine engines
- additional pressure gauge for pressure drop test



Item #
8401

Digital Compression Tester for Petrol Engines

- for compression measurement with hose adaptor or rubber-cone measuring tube
- spark plug thread adaptor: M10x1.0 - M12x1.25 - M14x1.25 - M18x1.5
- 63 mm gauge with LCD-display
- switchable units (psi, bar, kpa)
- pressure memory for up to 12 cyl.
- pressure range 0.1 - 20.6 bar (2.0 – 299.5 psi)
- resolution: 0.05 bar, 0.5 psi, 5 kpa
- automatic zero pressure calibration
- switchable backlight
- automatic off function, saves battery
- battery: 9V



Item #
8980

Vacuum and Fuel Pump Tester

- for checking mechanical fuel pumps, fuel lines and for leakage test on throttle valves, intake manifolds, vacuum hoses, etc.
- pressure / vacuum gauge with rubber bumpers and hanging hook, Ø 89 mm
- includes flexible hose and adaptor
- vacuum measuring range: 0 - 28 in HG (0 - 70 cm HG)
- pressure measuring range: 0 - 0.7 kg/cm² (0 - 10 psig)



Item #
9069

Pressure Loss Testing Kit | 7 pcs.

- for checking pressure tightness of single cylinders on diesel and gasoline engines
- includes dial indicator
- adaptor M12 x 1.25 mm for motorbikes
- adaptor M10 x 1.00 mm for motorbikes
- adaptor M24 x 2 mm for diesel engines
- adaptor M12 x 1.25 mm with 7 mm hole for VW diesel engines
- adaptor for multi valve engines
- adaptor for M14 x 1.25 and M18 x 1.5 mm
- working pressure: 6 - 12 bar

Application note: Before connecting to compressed air system the adjusting valve must be closed. Connect the device to the compressed air system and open the adjusting valve slowly until the pointer reaches the 0-mark!

Item #	Description
62645	Pressure Loss Testing Kit 7 pcs.
62645-1	Gauge for BGS 62645



Compression Tester

- 300 mm long, flexible test hose
 - large (Ø 70 mm) easy to read scale - accuracy: +/- 3 %
 - gauge range: from 0 to 21 bar / 21.5 kg/cm² / 300 PSI
 - blow off valve
 - to probe engine valve and piston rings
-
- BGS 8235: suitable for motorcycles and cars with M10 mm or M14 mm spark plug
 - BGS 8236: suitable for motorcycles and cars with M12 mm or M14 mm spark plug
 - BGS 8005: suitable for motorcycles and cars with M14 mm or M18 mm spark plug
-
- Application note: Shut down power of ignition coil before working with this tool!



Item #	Description
8235	Compression Tester M10 + M14
8236	Compression Tester M12 + M14
8005	Compression Tester M14 + M18
8005-10	Adaptor for Compression Tester for BGS 8005, 8235, 8236 M10 x 1.0
8005-12	Adaptor for Compression Tester for BGS 8005, 8235, 8236 M12 x 1.25



Compressed Air Cylinder Adaptor | M14 and M18

- for filling the cylinder with compressed air
- is used when removing valve springs without removing the cylinder head
- for acoustic leak testing of valves, piston rings, head gaskets, etc.
- suitable for spark plug threads M18 x 1.5 and M14 x 1.25
- also can be used in combination with BGS 1781, 1873, 1777 and 1762



Item #
8526

Compressed Air Adaptor Set for Glow Plug Holes | M8 x 1.0, M10x1.0, M10x1.25 | 3 pcs.

- to screw in the glow plug bores
- for filling the combustion chamber with compressed air
- required when removing / installing valve springs on installed cylinder heads and for pressure loss diagnosis
- 1 pneumatic adaptor for glow plug holes M8 x 1.0 for Citroën, Fiat, Ford, Lancia, Opel, Mercedes-Benz, Suzuki, Volvo
- 1 pneumatic adaptor for glow plug holes M10 x 1.0 for BMW, Chrysler, Opel, Mercedes-Benz, Nissan, Renault
- 1 pneumatic adaptor for glow plug holes M10 x 1.25 for Toyota, Lexus



Item #
9519

Gear Box Compression Test Kit

- for professional diagnosis of automatic gear mechanism
- long test hoses allow test from the driver's seat
- suitable for the following automatic gears:
 - VW, Mercedes-Benz, Honda, Hyundai, almost all series
 - Audi, VW 003, VW 010, VW 097, almost all ZF gears
 - BMW Borg Warner 65; almost all ZF gears
 - Chrysler A-Series rear-wheel drive, 32, 36, 42, 44, 46 RH + RE, A-series rear, 42LE, KM series, F3A
 - AMC / Eagle A604/41, 42LE, KM series, W4A32-1 ZF gears (Eagle Premier), MB-1, AR4, MJS (Renault), AW-4
 - Jeep A904, A999, A500, A518, A727, 30, 32RH Turbo HyDRY-Matic TH400
 - Ford A4LD, AOD, AXOD, ATX, C3, C4, C5, C6, AODE, E40D, 4R70W, 5R55E, AOT, Mazda gears 4EAT
 - GM Turbo Hydra-Matic, AL60E, 4L80E, AT60E Aisin Warner MX-1 + MS-7, JATCO KF-100
 - Isuzu Borg-Warner BW-35, AISIN Warner BW-35 JATCO F3A/F10, Hydra-Matic TH4L30E, 4L60E
 - Jaguar ZF gears, Borg-Warner 65, Hydra-Matic
 - Mitsubishi AISIN Warner, KM series, JATCO, torque Lite
 - Peugeot ZF gears, Mazda JATCO, Ford A4LD
 - Porsche 010 VW, ZF gears
 - Saab Borg-Warner 37, ZF gears
 - Toyota AISIN Warner A-20 + A-30, almost all models
 - Volvo AISIN Warner, Borg Warner, ZF gears
- high-pressure pressure gauge 0 - 500 PSI (0 - 35 bar), diameter 60 mm, hose length: 350 cm
- pressure gauge 0 - 100 PSI (0 - 7 bar) diameter 60 mm, tube length 200 cm
- 230 mm hose adaptor 1/8-27 to 1/4", quick coupling
- Adaptor:
 - 1/8-27 - M10x1.0
 - 1/8-27 - 1/16-27 NPT
 - 1/8-27 - 5/16-24 NF
 - 1/8-27 - M8x1.25
 - 1/8-27 - M8x1.0
 - 1/8-27 VW Audi
 - 1/8-27 - 1/8-28 BSPT
- adaptor internal thread 1/8-27 - external screw thread 1/4-18 NPT
- elbow: 1/8-27 - 90° + 1/8-27 - 45°
- adaptor 1/8-27, length: 50 mm



Test Devices

Item #
8028

Precision Straight Edge | 600 mm

- suitable for engines with up to 6 cylinders
- for using in combination with a feeler gauge
- tolerance: - 0.05 mm
- length: 600 mm
- width: 16 mm
- height: 36 mm
- material: steel (S50C)

Item #
8397



Measuring Cable and Probe Set | 92 pcs.

- suitable for all multimeters with 4 mm test socket
- for checking all types of electric circuits
- perfect for checking of car electricity
- 72 testing leads (=36 male and 36 female terminals)
- 2 pcs. 5 KOhm potentiometers (variable resistor)
- 2 LED stroboscopes
- 2 SRS connectors
- 2 alligator clips
- 2 standard probes
- 2 acicular probes
- 2 connectors "1 female to 2 male"
- 4 connectors "1 female to 1 male"



Item #	Description
2186	Measuring Cable and Probe Set 92 pcs.
2186-1	Potentiometer for BGS 2186

Measuring Cable and Probe Set | 92 pcs.

- for professional adaptation of testing equipment such as multimeters, oscilloscopes, simulators, etc. to the vehicle electricity
- facilitates testing works on electrical units by perfect electrical connection
- includes the following test adaptors:
 - 2 potentiometers (5 KOhm), to simulate temperature and throttle position sensors
 - 2 LED test adaptors, for testing voltage and ground signals, example: hall sensors, injectors, solenoid valves, etc.
 - 2 SRS airbag simulators for electrical simulation of airbag and belt tensioner generators
 - 4 test leads with banana plug on both sides, stackable
 - 4 needle probe
 - 2 probes
 - 2 1-to-2 connectors
 - 2 alligator clips
 - 24 test adaptors with round plugs / round sockets, dimensions 1.5 - 2.0 - 3.5 - 4.0 mm
 - 48 test adaptors with flat plug / flat sockets: sizes: 0.7 - 0.8 - 1.2 - 2.0 - 2.5 - 3.0 - 5.0 - 6.0 mm
- suitable for the most vehicles from Europe, America and Japan



Item #
2184

Universal Line and Accessories Assortment | 15 pcs.

- for use with multimeters, testing lights etc.
- 2 cables each 100 and 50 cm, red and blue
- 2 colored LED testing leads for polarity test
- 1 wire piercing probe
- 4 needle testing cables, red and black
- 2 testing tips, red and black
- 2 crocodile clamps, red and black
- suitable for automotive applications up to 24 V, 10 A



Item #
2185

Probe Assortment | 16 pcs.

- allows measurement on connectors and components without destroying the insulation or the plug connection
- 4 mm connection for banana plugs
- 4 mm banana plug
- 1.3 mm test needle
- male flat plug adaptor: 6.3 - 4.8 - 2.8 - 2.3 - 1.3 and 0.9 mm
- female flat plug adaptor: 6.3 - 4.8 - 2.8 - 2.3 - 1.3 and 0.9 mm



Item #
8516

Multimeter Test Leads | 4 mm

- suitable for measuring in extra low voltage range
- both sides with 4 mm plugs (stackable)
- 2 measuring cables (red)
- 2 measuring cables (black)
- length: 1000 mm



Item #
8937

Measuring Gripper with Cable Piercer

- allows measurements on insulated cables
- pierces cables isolations without major damage
- 4 mm measuring cable jack
- includes two measuring grippers: 1 red and 1 black



Item #
8993

Replacement Probes for Multimeter

- cable length approx. 630 mm
- probe length approx. 125 mm
- suitable for multimeters with 4 mm test sockets
- light type

Item #
2192-1



Replacement Probes for Multimeter

- cable length approx. 880 mm
- probe length approx. 150 mm
- test tip with protection cap
- suitable for multimeters with 4 mm test sockets
- heavy type

Item #
2194-1



Glow Plug Analyser | 12 V

- reduces the cost for glow plug testing
- removing of the glow plugs for testing is not necessary
- test results are shown on LED display
- suitable for testing of 12 V glow plugs
- easy to use

Item #
2178



Digital Clamp Meter

- LCD display, 3 1/2-digit (up to 1999 count)
- reading rate: 3 reading/sec
- polarity indication
- overload indication
- dimensions: (L x W x H) 193 x 73 x 25 mm
- weight: 145 g (incl. battery)
- power requirements: 2 1.5V (AAA)
- incl. storage bag, 2 measuring cables and 2 batteries

measuring ranges:

- DC voltage: 200 V / resolution: 100 mV, 600 V / resolution: 1 V
- AC voltage: 200 V / resolution: 100 mV, 600 V / resolution: 1 V
- AC current: 2000 mA / resolution 1 mA, 20 A / resolution 10 mA, 600 A / resolution 1 A
- resistance (Ohm): 200 Ohm / resolution 0.1 Ohm , 200 KOhm / resolution 100 Ohm

Item #
2203



Digital Multimeter with Clamp for DC and AC Current

- designed especially for the automotive sector, but can also be used in other areas
- 3 - 3/4 digits LCD max. display value 3999
- battery: 2 1.5 V AAA or similar
- low battery indicator
- storage condition: from -10°C to +50°C, max. 85% RH
- dimensions: 194 x 71 x 38 mm
- weight: about 215 g (including batteries)
- suitable for category CAT II

measuring ranges:

- AC and DC voltage measuring ranges: 400.0 mV, 4.000 V, 40.00 V, 400.0 V, 600 V
- resistance: 400 Ohm, 4 KOhm, 40 KOhm, 400 KOhm, 4 MOhm, 40 MOhm
- AC and DC current up to 400 A, smallest measure 100 mA
- indicator for negative polarity and overrange
- max. clamp opening: 33 mm, max. cable: Ø 28 mm

Item #
2202



Car Voltage and Current Tester | 1 - 48 V

- ideal for the diagnosis of electrical circuits on cars
- this meter is fast, accurate and safe to use
- is used to measure currents (directly to the fuse socket) and voltage
- current measurement: up to 30A at 48 VDC (max. 10 sec.), accuracy: $\pm 1\%$
- voltage measurement: 1 - 48 VDC, accuracy: $\pm 1\%$
- working temperature: 0°C to 50°C
- storage temperature: -20°C to 60°C
- humidity: less than 70% RH (working); less than 80% RH (storage)
- max. height: 2000 m
- power supply: 1x 9V battery
- 1 voltage and current meter
- 2 alligator clips (red / black)
- 1 voltage measurement cable with "cigarette lighter plug", length 950 mm
- 1 current measurement cable with fuse adaptor, length 600 mm
- 1 measurement cable (red), insulated connectors on both sides, length 900 mm
- 1 measurement cable (black), insulated connectors on both sides, length 900 mm
- 2 test probes (red / black) with 4 mm banana plugs and non-contact caps



Item #
8890



Automotive Circuit Tester

- especially useful and handy multimeter with single-handed control
- for testing electric 6 - 24 V systems on cars, trucks and motorcycles
- bright LED guarantees a well lit work space
- easy troubleshooting by applying positive or negative potentials, max. current 10 A, automatically resetting fuse
- potential is indicated by 2 alternatively colored LEDs – comes in handy when testing ignition and injection systems
- built-in continuity tester with optical signal
- 6 meter power supply cable is sufficient for measurements on cars and motorcycles
- additional 6 m extension cord with reverse polarity protection for applications on trucks and trailers
- with reverse polarity protected voltage adaptor for connecting the multimeter with batteries
- with reverse polarity protected voltage adaptor for connecting the multimeter with your vehicle's cigarette lighter



Item #
40100



Multi-Function Voltage Tester

- especially useful and handy multimeter with single-handed control
- for testing electric 12 - 24 volt systems on cars, trucks and motorcycles
- bright LED guarantees a well lit work space
- easier troubleshooting by connecting from a positive or negative potential, max. current 10 ampere
- automatically resetting fuse
- potential is indicated by 2 alternatively colored LEDs – comes in handy when testing ignition, injection and other pulsed voltage systems
- illuminated display
- built-in continuity tester with optical signal
- frequency measurements up to 8000 Hz
- non-contact measurement of KV ignition test for detecting missing ignition voltage
- 6 meter power supply cable is sufficient for measurements of cars and motorcycles
- 6 meter extension cable for measurements of trucks or trailers
- reverse polarity protected DC power adaptor for connection to battery
- reverse polarity protected DC power adaptor for connection to board socket (Cigarette lighter)
- special tip for measurements on low-lying contacts
- 6 adjustable voltage threshold 0.5 V - 1.0 V - 2.0 V - 5.0 V - 10.0 V - 48 V, as soon as the measured voltage is higher than the preset threshold, an acoustic signal will sound
- the measurement options are selected by push buttons



Item #
40105



Voltage Detector with Digital Display

- LCD display for AC and DC voltage from 24 V to 690 V
- LED display in following 5 voltage steps: 24 V, 50 V, 120 V, 230 V, 400 V and 690 V
- phase rotation indicator: frequency 50 - 60 Hz / voltage 0 V - 690 V
- continuity tester with acoustic and optical display
- single-pole voltage test
- polarity detection positive / negative (LED display)
- protection class: IP65
- battery test, indicates when the internal battery is weak
- power supply: 2x 1.5 V (R03)
- weight 210 g
- length: 275 mm
- width: 51 mm
- height: 30 mm



Item #
40110



Digital Car Multimeter with USB Interface

- ideal automotive measuring tool
- suitable for 2 and 4-stroke engines
- illuminated 3 5/6 digit display
- USB port for connection to PC
- auto-range, automatically selects the range size
- relative mode, enables differential measurement
- data hold function, freezes the measured value
- overload indication
- low battery indicator

measuring ranges:

- DC voltage: 6 V - 60 V - 600 V - 1000 V
- AC voltage: 6 V - 60 V - 600 V - 1000 V
- DC current: 60 mA - 600 mA - 6 A - 20 A
- AC current: 60 mA - 600 mA - 6 A - 20 A
- resistance: 600 Ohm - 6 KOhm - 600 KOhm - 6 MOhm - 60 MOhm
- continuity: buzzer sounds under 20 Ohm
- diode: test current approx. 0.8 mA
- capacity: 40 nF to 4000 uF
- temperature: -20 to 400 °C
- frequency: 10 Hz to 10 MHz
- duty cycle: 0.5 % to 99.9 %
- drive speed: 120 to 20,000 rpm
- dwell: 0° - 90° / 0° - 72° / 0° - 60° / 0° - 45°
- pulse width: 0.5 ms to 20 ms
- temperature probe
- condenser adaptor
- inductive pick up
- 2 measuring cables
- USB cable
- CD with driver/software
- pouch and 9-V battery



Item #
63401



Digital Multimeter | 3 1/2-digit

- shock resistant plastic protection
- with put-up hinge
- energy-saving LCD display
- data hold button
- power supply: 9V block battery
- suitable for measurements in CAT II area

measuring ranges:

- DC voltage: 200 mV - 2 V - 20 V - 200 V - 600 V
- AC voltage: 200 V - 600 V
- resistance: 200 Ohm - 2-component Ohm - 20 KOhm - 200 KOhm - 2 MOhm
- DC current: 20 µA - 200 µA - 2 mA - 20 mA - 200 mA - 10 A
- diode forward voltage



Item #
63402



Digital Multimeter

- 3.5-digit LCD
- low battery indication
- overload protection
- manual range selection
- safety sockets and plugs

measuring ranges:

- DC voltage: 200 mV, 2000 mV, 20 V, 200 V, 250 V
- AC voltage: 200 V, 250 V
- DC current: 200 μ A, 2000 μ A, 20 mA, 200 mA, 10 A
- resistance: 200 Ohm, 2000 Ohm, 20 kOhm, 200 kOhm, 2000 kOhm
- audible continuity sounds under 50 Ohm
- diode test with forward voltage reading



Item #	CE	
63400		

Digital Multimeter | 3 1/2-digit

- suitable for measurements in CAT II area
- 3 1/2 digit, 7 segments, 12.5 mm LCD
- indication for overflow, polarity and low battery voltage
- measuring ranges for resistance, AC voltage, DC voltage, diode voltage drop and hFE transistor measurements
- operating temperature: 10°C ~ 40°C, 0 ~ 75 % relative humidity
- power supply: 2 1.5 V AAA battery
- weight: 140 g (incl. battery)

DC voltage measuring ranges:

- 200 mV, resolution: 10 μ V, accuracy: ± 0.5 % +10 digit
- 2000 mV, resolution: 1 mV, accuracy: ± 1 % +5 digit
- 20 V, resolution: 10 mV, accuracy: ± 1 % +5 digit
- 200 V, resolution: 100 mV, accuracy: ± 1 % +5 digit
- 600 V, resolution: 1 V, accuracy: ± 1.2 % +5 digit

AC voltage measuring ranges:

- 200 V, resolution: 10 mV, accuracy: ± 0.5 % +10 digit
- 600 V, resolution: 1 V, accuracy: ± 0.5 % +10 digit

DC current measuring ranges:

- 200 μ A, resolution: 100 nA, accuracy: ± 1.8 % +2 digit
- 2000 μ A, resolution: 1 nA, accuracy: ± 1.8 % +2 digit
- 20 mA, resolution: 10 μ V, accuracy: ± 1.8 % +2 digit
- 200 mA, resolution: 100 μ A, accuracy: ± 2 % +2 digit
- 10 A, resolution: 10 mA, accuracy: ± 2 % +10 digit

resistance measuring ranges:

- 200 Ohm, resolution: 0.1 mOhm, accuracy: ± 1 % +10 digit
- 2000 Ohm, resolution: 1 Ohm, accuracy: ± 2 % +4 digit
- 20 KOhm, resolution: 10 Ohm, accuracy: ± 2 % +4 digit
- 200 KOhm, resolution: 100 Ohm, accuracy: ± 2 % +4 digit
- 2000 KOhm, resolution: 1 KOhm, accuracy: ± 2 % +4 digit

- length: 126 mm
- width: 70 mm
- height: 24 mm

Item #	CE	
9074		



Fuse Tester

- suitable for mini, standard and maxi fuses
- LED does not light if fuses are damaged
- with clip for fuse removal



Item #
8468



Digital Current Tester for Fuse Contact

- current measurements directly at the fuse box of cars and trucks
- helps to e. g. find "hidden" currents
- application: to measure, remove the original fuse and connect the tester plug
- protection of the circuit is still provided by a fuse in the tester
- plugs both for mini fuse and standard fuse sockets
- suitable for 12 V and 24 V systems
- max. current: 20 A



Item #
63520



Diode Testing Light with LED Display | 3 - 48 V

- allows piercing of insulated cords



Item #
723



Voltmeter

- 12 - 400 V AC voltage
- 12 - 500 V DC voltage
- 2-poles
- 5-way LED polarity light
- 12 Volt / 50 Volt / 120 - 150 Volt / 220 - 230 Volt / 400 - 500 Volt



Item #
724



Voltage tester | 120 - 250 V | 140 mm

- with lens and metal clip
- length: 140 mm



Item #
725

Car Light tester | 6 - 24 V

- with needle with screwable top



Item #	Description
2072	Car Light tester 6 - 24 V
72	Replacement Bulbs for BGS 2072



Electronic Stethoscope

- easily finds the origin of noises and reduces the diagnosis time
- 1-way amplifier allows fast and uncomplicated acoustic testing. e. g. to test alternators and other parts of the engine
- includes 6-way amplifier and 6 color-coded probes
- allows troubleshooting while driving at various test points
- with alligator clips for easy attaching to the test points
- for mounting on e.g. engine, transmission and axle parts
- headset features a padded headband and ear cups for excellent wearing comfort



Item #
3531



Electronic Stethoscope

- the stethoscope allows fast and easy locating of noises and helps to find the cause of a motor problems



Item #	Description
3530	Electronic Stethoscope
3530-1	Microphone Main Unit for BGS 3530

Electronic Stethoscope

- easily finds the origin of noises and reduces the diagnosis time
- allows fast and uncomplicated acoustic testing, e. g. to test alternators and other parts of the engine
- headset features a padded headband and ear cups for excellent wearing comfort



Item #
3532



Mechanics Stethoscope

- with steel tip
- suitable for detecting faults in engines, bearings and other moving parts



Item #
3535



Digital Laser Thermometer | -50°C to 500° C

- accurately measures hot and cold temperatures
- ideal for various applications, helps to detect problems in car engines, heating and cooling systems, production and also in the food industry
- works contactless by infrared laser
- temperature range: -50 to +500°C (58 to 932°F)
- accuracy +/- 1.5 %
- laser wave length: 8 - 14 um, laser class II
- response time approx. 1 second
- distance to spot size D/S 12 : 1
- measuring range can be switched between: °C / °F
- power: 2 1.5V AAA- Batteries, not included in the delivery



Item #
6005



Digital Thermometer with Stainless Steel Sensor Probe

- wide range of applications, suitable for e.g. air conditioning, food processing, heating and ventilating, agriculture, automobile, photography, food storage, refrigeration, laboratory, etc.
- memory of the last measured value
- low battery display
- sensor fault display
- auto power off after 15 min.
- switch between °C and °F
- temperature range: -50°C to +300°C (-58°F ~ +572°F)
- temperature steps: 0.1 °C
- accuracy: (-20°C - 80°C) +/- 1°C
- power: 1.5 V battery (LR44)
- length of probe: 125 mm
- incl. measuring tip protector with clip



Item #
8714



Vacuum / Pressure Pump Set

- 2-way: vacuum and pressure
- for brake bleeding
- tests of various under / over-pressure systems e. g. turbo-charge pressure tests
- with manometer up to 4 bar (tolerance +/- 5%)
- several accessories



Item #	Description
8067	Vacuum / Pressure Pump Set
8067-1	Vacuum / Pressure Pump for BGS 8067
8067-2	Replacement Gauge for BGS 8067

Vacuum / Pressure Pump Set

- suitable for checking pressure and vacuum systems like boost pressure, vacuum solenoid valves, tank vents, MAP sensors, etc.
- also suitable for brake bleeding
- not suitable for fuel system (petrol/diesel)
- 63.5 mm pressure / vacuum gauge
- pressure indicator range: +0 to +3 bar
- vacuum indicator range: -0 to -1 bar
- max. vacuum: -0.7 bar
- max. pressure: 3 bar



Item #
8038

Wheel Balancing Weight Pliers | 225 mm

- extra narrow gripping profile
- for loosening glued balance weights
- plastic protection head on Hammer head for striking the weights (especially suitable for painted weights)
- plastic protective cap prevents from damaging aluminum rims
- 2 step adjustable for narrow and wide weights
- with blue dipped handles
- self-opening with internal spring



Wheel Balancing Weight Pliers | 240 mm

- dip insulated handles
- length: 240 mm
- surface finish: chrome plated



Wheel Balancing Weights | 12 x 5 g | 50 pcs.

- total weight: 60 g, can be divided in 5-g steps
- with anti-corrosion coating
- self-adhesive
- material: steel

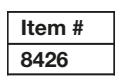

Wheel Balancing Weights | type 363 | 45 g | 100 pcs.

- particularly suitable for aluminium rims
- perfect to use with wheel balancing weight pliers BGS 1539 and scraper BGS 366
- material: zinc
- contents: 100 x 45 g bar
- distribution of each bar 5-10-5-10-5-10 g
- application range: -20°C - +70°C

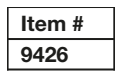

Wheel Balancing Weight Set | 320 pcs.

- for steel rims
- can be used with wheel balancing weight pliers BGS 1539, 9500
- in reusable assortment box
- all sizes individually available, as refill pack
- material: zinc

- 100 x 5 g
- 100 x 10 g
- 20 x 15 g
- 20 x 20 g
- 20 x 25 g
- 20 x 30 g
- 20 x 35 g
- 10 x 40 g
- 10 x 45 g



Item #	Description
9425	Wheel Balancing Weight Set 320 pcs.
9425-5	Balancing Weights 5 g 100 pcs.
9425-10	Balancing Weights 10 g 100 pcs.
9425-15	Balancing Weights 15 g 100 pcs.
9425-20	Balancing Weights 20 g 100 pcs.
9425-25	Balancing Weights 25 g 100 pcs.
9425-30	Balancing Weights 30 g 100 pcs.
9425-35	Balancing Weights 35 g 50 pcs.
9425-40	Balancing Weights 40 g 50 pcs.
9425-45	Balancing Weights 45 g 50 pcs.

Rim Bore-Circle Callipers, Aluminium Type

- for measuring the hole circle on steel and aluminium rims
- greatly facilitates the determination of the hole circle
- suitable for 3-, 4-, 5- and 6-hole rims

Item #
8367-1



Rim Bore-Circle Callipers

- for measuring the hole circle on steel and aluminium rims
- greatly facilitates the determination of the hole circle
- suitable for 4 -, 5 -, 6 - and 8-hole rims

Item #
8367

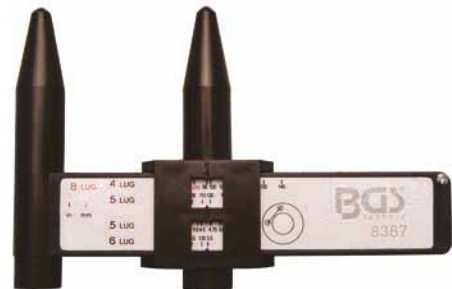

Digital Tyre Depth Gauge | 0 - 28 mm

- measuring range up to 28 mm
- mm / inch display
- battery included

Item #
1941



Tyre Pressure Control System Tool Set (TPMS) | 13 pcs.

6.3 1/4

- allows professional installing of tire pressure sensors
- 1 torque wrench, external square 6.3 mm (1/4"), 1 - 6 Nm, accuracy: +/- 3 %
- 1 universal joint, 6.3 mm (1/4")
- 3 bit sockets, 6.3 mm (1/4") drive, T-Star (for Torx): T10 - T15 - T20
- 1 extension bar 6.3 mm (1/4"), 100 mm
- 2 Pro torque® hexagon sockets, 6.3 mm (1/4") drive, 11 and 12 mm
- 1 torque driver for sensors
- 1 valve torque tool
- 1 valve thread cutter
- 1 combination spanner, 10 mm
- 1 pin punch



Item #
8919



Tyre Pressure Control System Tool Set (TPMS) | 18 pcs.

6.3 1/4

- includes a 1-8 NM torque screwdriver and following 6.3 mm (1/4") tools:
- hexagon Pro torque® deep sockets, 11, 12 mm
- hexagon Pro torque® socket, 6 mm
- bit socket T-Star (for Torx) T20
- adaptor for 6.3 mm (1/4") bits
- sliding bar
- 100 mm extension bar
- 10 bits, 6.3 mm (1/4") drive:
 - slot SL 5.5 - 4.5 mm
 - T-Star (for Torx) T15 - T20
 - cross slot PH1 - PH2 - PH3
 - cross slot PZ1 - PZ2 - PZ3

Item #
8889



Tyre Service

Digital Tyre Pressure Gauge

- measuring range: 0.35 - 7.00 bar
- display reads in: bar, PSI, kPA, kg/cm²
- accuracy: +/-1 PSI / 0.07 bar

Item #
2101



Car Tyre Booster

- tire booster helps filling tires with loose beads as a result of e. g. prolonged storage
- max. pressure: 11 bar, limited by safety valve
- tank capacity: 20 l
- weight approx. 13 kg
- length: 260 mm
- width: 420 mm
- height: 300 mm

Item #
8365

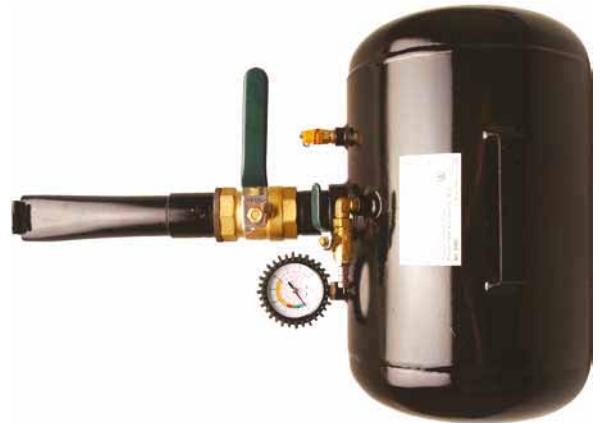

Tyre Service

Markers | white | 12 pcs.

- for marking tires, metals, etc.
- waterproof

Item #
8822



Markers | yellow | 12 pcs.

- for marking tires, metals, etc.
- waterproof

Item #
8823



Colour Coded Tire Deflating Caps for TPMS Valves | 4 pcs.

- no need to remove TPMS valve core
- safe release of the tyre air
- position marks help users to install the tyre back in the same position
- save time, no reset of TPMS system with computer necessary
- thread cup size: 5/16" x 32 UNEF
- pin size: M3 x P0.5
- colour coding
 - red: RF (right-front)
 - blue: RR (right-rear)
 - yellow: LF (left-front)
 - green: LR (left-rear)



Item #
9271

Wheel Stud Mounting Set

- allows easy mounting without a second person
- for installing following wheel stud sizes: M12 x 1.25 - M12 x 1.5 - M12 x 1.75 - M14 x 1.5 - 7/16" x 20 UNF - 1/2" x 20 UNF
- counterholding tool, prevents rotation of the wheel hub during assembly
- pressure sleeve with bearing for easy mounting
- installation nut 1/2" x 20 UNF
- installation nut 7/16" x 20 UNF
- installation nut M14 x 1.25
- installation nut M12 x 1.25
- installation nut M12 x 1.5
- installation nut M12 x 1.75
- rethreading tool M12 x 1.25
- rethreading tool M12 x 1.5
- rethreading tool M12 x 1.75
- rethreading tool M14 x 1.5



Item #	
8879	

Tyre Bead Retainer

- facilitates the installation of tires
- made of durable plastic
- protects aluminum rims



Item #
8658

Tyre Bead Retainer

- facilitates wheel mounting on rim
- length: 290 mm
- width: 150 mm
- height: 50 mm
- material: fibre glass (30%)

Item #
8655



Edge Protection Set | 150 mm | 2 pcs

- prevents rim damage when mounting tires
- suitable for motorcycle and car rims
- with cord against loss

Item #
8504

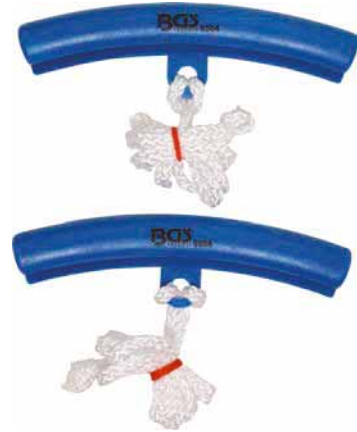

Loosening Tool for Wheel Nut Covers

- wheel nut caps can be removed without damaging the rims
- especially suitable for aluminum rims
- gripping claws made of spring steel
- T-handle for easy working

Item #
8257



Special Socket for spare tyre locking mechanism | Toyota, Lexus

- 21 mm x 5-pt
- suitable for impact wrench

Item #
9270



Round Brush for Tyre Mounting Paste

- diameter 30 mm
- 45° angled head

Item #
4803



Tyre Fitting Grease | black | 5 kg

- for easy and gentle tire mounting
- suitable for the most tires (not for runflat tires)
- in a bucket

Item #
9382



Tyre Fitting Grease For Run Flat Tyres | blue | 5 kg

- for easy and gentle tire mounting
- suitable for runflat tires

Item #
9383



Tyre Lever | Heavy Duty Finish

- suitable as tyre and all-purpose assembling tool
- for fixing and pulling off the tyres
- surface satin chrome plated



Item #	Description
1435	Tyre Lever 250 mm
1436	Tyre Lever 400 mm
1437	Tyre Lever 500 mm
1438	Tyre Lever 600 mm
1439	Tyre Lever 750 mm



Tyre Lever Set | 300 - 400 - 500 - 600 mm | 4 pcs.

- hardened
- supplied in a wallet
- surface finish: chrome plated

Item #
1548



Tyre Levers | with Plastic Protection Cover

- for damage free assembly of tires on aluminum rims
- exchangeable plastic pad (thickness 5.5 mm) is attached to steel lever with screws

Item #	Description
1527	Tyre Lever with Plastic Protection Cover 380 mm
1527-1	Spare Plastic Protection Cover for BGS 1527
63150	Tyre Lever with Plastic Protection Cover 500 mm
63151	Spare Plastic Protection Cover for BGS 63150



Tyre Lever | 380 mm

- hardened
- length: 380 mm
- surface finish: chrome plated

Item #	Image
1540	



Tyre Levers

- hardened
- carbon steel
- surface finish: chrome plated

Item #	Description
1530	Tyre Lever 250 mm
1531	Tyre Lever 400 mm
1532	Tyre Lever 500 mm
1533	Tyre Lever 600 mm
1534	Tyre Lever 750 mm



Tyre Repair Plugs

- for using with a stitch awl

Item #	Description
8900	Tyre Repair Plugs 102 mm 50 pcs.
8908	Tyre Repair Plugs 204 mm 25 pcs.
8901	Mounting Paste for BGS 8900

8900



8901



Stitch Awl for Tyre Repair

- for reaming of damaged spot

Item #
8904



Inserts Installing Tool for Tyre Repair

- for inserting the repaired plugs

Item #
8906



Tyre Dolly | 200 kg

- suitable for transporting of up to 4 wheels
- wheel buckets facilitate picking up the wheels
- after picking up the wheels, the trolley can be tilted in a user-friendly transport position, the entire weight of the wheels is supported by the transporting frame
- suitable for wheels of cars, SUVs and vans
- 2 wheels with steel rim and 260 mm air tire
- 2 swivel casters with plastic rim and 140 mm rubber tires
- capacity: 200 kg
- length: 1160 mm
- width: 540 mm
- height: 1530 mm

Item #
9025



Tire Valve Inserting Tool Set | 4 pcs.

- allows economic renewing of tire valve stems without dismantling the tire from rim
- 1 extractor for pulling out the defective valve stems
- 1 mounting tool, consisting of a mounting shaft and cone



Item #	Description
8766	Tire Valve Inserting Tool Set 4 pcs.
8766-1	Replacement Tyre Valve for BGS 8766



Silent Tyre Deflator

- allows silent air deflating of vehicle tires

Item #
9287



Tyre Valve Inserting Tool | extra thick Plastic Protection

- for mounting wheel valves
- particularly suitable for aluminium rims, but also suitable for other rims
- plastic protection for damage-free assembly
- length: 260 mm

Item #
9471



Tire Valve Inserting Tool

- easy assembly of new valves into the valve hole of the rim of tubeless tyres
- suitable for all sorts of rims
- length: 310 mm

Item #
1535



Tyre Valve Inserting Tool

- plastic, perfect for aluminium rims
- length: 285 mm

Item #	
1538	



Tyre / Valve Insert Tool | 2 pcs.

- for the assembly of valve inserts
- length: 130 mm

Item #	
1536	



Valve Core Torque Tools

- for screwing in rubber-sealing valves
- no more overwinding, no more damaged seals
- acoustic alert when reaching the max. torque



Item #	Description
1550	Valve Core Torque Tool 0.25 Nm
1551	Valve Core Torque Tool 0.45 Nm



Tyre Valve Cutting Tool

- for cutting-off tyre valves
- allows fast renewing of tyre valves
- cutting edge width: 18 mm
- cutting edge opening: max. 30 mm
- length: 230 mm

Item #	
8881	



Tyre Valve Repair Kit | 14 pcs.

- 1 thread repair cutter
- 1 pencil gauge with key chain
- 4 plastic caps
- 4 chrome plated hex caps
- 4 valve inserts

Item #
3272



Thread Tap for Tyre Valves

- suitable for car tire valves
- features: turning out of valves and recutting of valve threads



Item #
8453



Dead Blow Hammer | Head Ø 50 mm

- steel tube shaft
- rubber coated handle
- length: 330 mm
- weight: 850 g



Item #
1863



Dead Blow Hammer | Head Ø 60 mm

- made of polyurethane - fibre glass
- all rubber coated
- blow-back proof due to steel balls in the head of the mallet, therefore stronger impact
- especially for loosening stuck rims when changing tires
- handle length: 380 mm
- weight 1,300 g



Item #
1868

Dead Blow Hammer

- blow-back proof due to steel balls in the head of the mallet, therefore stronger impact
- especially for loosening stuck rims when changing tires

- BGS 1968: for cars
- BGS 1876: extra heavy duty for trucks and SUVs



Item #	Description
1968	Dead Blow Hammer Head Ø 70 mm
1876	Dead Blow Hammer Head Ø 105 mm

Parts Washer | 230 V

- for cleaning of small parts
- cleaner brush is rinsed for best cleaning results
- suitable for all mildly alkaline, water soluble cleansers, e. g. universal cleaner, 5l BGS 9380
- capacity: min. 15 litre
- dimensions (W x D x H): 640 x 440 x 260 mm



Item #
8693



Ultrasonic Parts Cleaner | 13 l

- for cleaning carburetor parts, tools, injectors, jewellery, watch bands, coins, collectibles, etc.
- removes dirt effectively
- with heater for heating cleaning fluid
- housing, container and lid made of stainless steel
- container size: 330 x 300 x 150 mm
- drain valve for draining the cleaning fluid
- length: 550 mm
- width: 330 mm
- height: 310 mm
- tank capacity: 13 l
- adjustable cleaning time: 0 - 20 min
- max. heating capacity: 400 W
- power supply frequency: 50 Hz
- power supply voltage (AC): 220 - 230 V
- temperature adjustment: 20 - 80 °C
- ultrasonic frequency: 40 kHz
- ultrasonic power: 300 W



Item #
8960



Ultrasonic Parts Cleaner | 3 l

- for cleaning carburetor parts, tools, injectors, jewellery, watch bands, coins, collectibles, etc.
- removes dirt effectively
- with heater for heating cleaning fluid
- housing, container and lid made of stainless steel
- container size: 230 x 130 x 100 mm
- length: 270 mm
- width: 170 mm
- height: 240 mm
- tank capacity: 3 l
- adjustable cleaning time: 0 - 20 min
- max. heating capacity: 100 W
- power supply frequency: 50 Hz
- power supply voltage (AC): 220 - 230 V
- temperature adjustment: 20 - 80 °C
- ultrasonic frequency: 40 kHz
- ultrasonic power: 100 W



Item #
8990



Laundry Basket for Small Parts

- for washing / draining of small parts
- tight net prevents loss of small parts
- made of stainless steel
- with magnetic feet, 6 kg holding force
- top diameter: 273 mm
- bottom diameter: 85 mm
- capacity: 2.3 l
- weight: 360 g

Item #
8992



Mechanic's Creeper / Seat

- can be used as a seat or a creeper
- facilitates maintenance and service works
- creeper dimension: (L x W x H) 1030 x 450 x 150 mm
- steel frame, coated
- castors: 6 pieces
- seat surface: 520 x 450 mm
- seat height: 540 mm
- max. load capacity as a recliner 150 kg
- max. load capacity as seat 130 kg



Item #
2850



Mechanic's Creeper / Seat

- with double ball bearing rolling wheels
- persistent synthetic leather padded cover
- converts easily from creeper to seat and back, adjustable
- lying surface: 1060 x 310 mm (with headrest)
- lying height: 120 mm
- headrest: 160 x 310 mm
- overall size: 1200 x 420 x 120 mm
- seat surface: 320 x 310 mm
- seat height: 445 mm
- max. load capacity as a recliner 150 kg
- max. load capacity as seat 130 kg



Item #	Description
2995	Mechanic's Creeper / Seat
2997	Spare Wheel for BGS 2995

Workshop Creeper | 1000 x 420 mm

- square metal frame
- size 1000 x 420 x 100 mm
- padded cover
- 6 swivel casters with ball bearing rubber wheels for easy movement
- capacity: 130 kg



Item #
2992



Workshop Creeper | with work lamp | 1030 x 500 mm

- material: durable PE plastic
- 6 castors Ø 75 mm
- 1030 mm length x 500 mm width
- LED work light for under car lighting included
- comfortable head rest
- max. capacity: 150 kg



Item #	Description
2996	Workshop Creeper with work lamp 1030 x 500 mm
2996-1	Gooseneck Lamp with 4 LEDs for BGS 2996

Workshop Creeper | 1000 x 510 mm

- heavy and robust execution
- ergonomically shaped head rest
- 6 rolling wheels
- capacity: 110 kg



Item #	Description
2994	Workshop Creeper 1000 x 510 mm
2989	Replacement Wheel for BGS 2994, 2996

Workshop Seat with 5 Castors | Ø 360 mm

- padded seat
- large storage compartment in the base
- height-adjustable through hydropneumatics
- height: 450 - 580 mm
- seat: Ø 360 mm
- shelf plate: Ø 440 mm
- capacity: 135 kg
- castor size: 75 mm



Item #
8388



Mechanics Creeper with Drawer

- stable steel pipe frame (25 x 25 mm)
- 4 castors Ø 50 mm
- seat surface: 365 mm width x 210 mm depth
- drawer internal dimensions (W x D x H): 275 x 185 x 55 mm
- dimensions (W x D x H): 360 x 410 x 330 mm
- max. capacity: 90 kg



Item #
2832

Roller Seat

- tool storage tray underneath the seat
- plastic
- black
- with 4 wheels



Item #	Description
1919	Roller Seat
1916	Replacement Wheel for BGS 1919

Wheeled Sliding Kneeboard | max. 100 kg

- for fatigue-free working
- 5 castors for high stability
- padded knee troughs
- with storage and carry handle
- max. capacity: 100 kg



Item #
8807

Mechanic's Protection Mat | 1200 x 435 x 35 mm

- allows comfortable working under the vehicle
- foldable, requires little storage space
- with headrest and carrying strap



Item #
4805

Knee Protector | 1200 x 540 x 30 mm

- soft and stable material facilitates your job and protects your knees
- oversized, also suitable as upper body pad
- oil, acid and fuel resistant



Item #
4804

Knee Protector | 450 x 210 x 30 mm

- with storage compartment, prevents rolling away of tools and parts
- acid-resistant EPE foam

Item #
4801



Knee Protector | 480 x 320 x 36 mm

- oil, acid and fuel resistant
- EVA foam

Item #
4800



Universal Fender Cover | magnetic

- protects the car body during repair jobs
- top and bottom side made from durable nylon material
- holds onto the car body through sewed-in magnets
- protection against scratches, dirt, oil, etc.

Item #
3232



Protective Seat and Steering Wheel Cover

- protects against pollution from grease, oil, water, food scraps and other materials
- can be easily cleaned by wiping off with a damp cloth or sponge
- consists of seat, steering wheel and gear knob cover

Item #	Description
66529	Protective seat and steering wheel cover universal imitation leather
66531	Protective seat and steering wheel cover universal polyester



Automotive Clip Assortment for VW vehicles | 255 pcs.

- 30 door moulding clips, to be used as VW / Audi OE No. 6U085733
- 20 trunk lining retainers to be used as OE No. VW N9020160H, Ford 6998849, BMW 514719044317, Opel 2207713 and suitable for many other vehicles
- 30 drive rivets, to be used as OE No. VW / Audi N0385501, Peugeot 781424 and suitable for many other vehicles
- 5 round retaining clips, to be used as VW / Audi OE No. 1H0868243B
- 30 screw grommets 15 x 12 mm, to be used as VW / Audi OE No. N90833801 and suitable for many other vehicles
- 20 retaining clips, to be used as OE No. VW 3A0853575, Audi 3A0853575A
- 15 moulding clips 34.9 x 21.9 mm, to be used as OE No. VW 4A0853825, Audi 4A0853825A
- 10 retaining clips 22 x 25 x 10 mm, to be used as VW / Audi OE No. 3B0853576
- 25 retaining clips, to be used as VW OE No. 1H0819055B01C and suitable for many other vehicles
- 15 retaining clips, to be used as VW OE No. 443853909A
- 30 push-type plastic retainers, to be used as VW OE No. 171885767 and suitable for many other vehicles
- 25 plastic screw nuts, to be used as VW / Audi OE No. 191941142



Item #	
8129	

Automotive Clip Assortment for Ford, Mazda, GM, Chrysler, Nissan | 415 pcs.

- 25 wiring harness clips, to be used as Ford OE 388577S
- 20 push-type clips, to be used as GM OE 10139822, Ford OE 1673046, Chrysler OE 6508197AA
- 30 connecting clips, to be used as Mazda OE B45556741, Ford OE F1CZ16674A
- 15 moulding clips, to be used as Ford OE N8011925S
- 40 door and window rubber seal clips, to be used as Ford OE N806289S
- 30 nut inserts, to be used as Ford OE N379830S
- 10 moulding clips, to be used as Ford OE N387496S
- 35 wiring harness clips, to be used as Ford OE N803170S
- 10 push-type clips, to be used as Ford OE W704958S300
- 20 push-type clips, to be used as Mazda OE NAU156145, Ford OE W706713S300
- 35 wiring harness clips, to be used as Ford OE N388246S
- 15 connecting clips, to be used as Ford OE N387944S
- 20 push-type clips, to be used as Ford OE N805231S
- 15 connecting clips, to be used as Ford OE W705532S300
- 15 push-type connection clips, to be used as Ford OE W710250S300
- 35 rear light clips, to be used as GM & Ford OE 16500308, Chrysler OE 6500787
- 30 hood insulated clips, to be used as Mazda OE 6508197AA, Ford OE F22Z16774A
- 15 push-type clips, to be used as OE Ford OE 1007932, Nissan OE 6384401A00



Item #	
9041	

Automotive Clip Assortment for BMW, VW | 290 pcs.

- 35 bumper panel clips, to be used as BMW OE 51118174185
- 40 panel clips, to be used as BMW OE 703867299, VW OE 823867299
- 80 nut inserts, to be used as BMW OE 51311802258
- 80 connecting clips, to be used as BMW OE 51131804205
- 35 push-type clips, to be used as BMW OE 51481938725
- 20 push-type clips, to be used as BMW OE 51131960054

Item #
9042



Automotive Clip Assortment for Mercedes-Benz | 270 pcs.

- 30 plastic nut inserts, to be used as Mercedes-Benz OE A108980027, Renault OE 7703074022
- 15 push-type clips, to be used as Mercedes-Benz OE A1269900392
- 30 connecting clips, to be used as Mercedes-Benz OE A0019882981
- 25 push-type clips, to be used as Mercedes-Benz OE A1249900492
- 5 connecting clips, to be used as Mercedes-Benz OE A0019888081
- 10 connecting clips, to be used as Mercedes-Benz OE A1249880492
- 15 push-type clips, to be used as Mercedes-Benz OE A9904692
- 40 push-type clips, to be used as Mercedes-Benz OE A0009908492
- 30 connecting clips, to be used as Mercedes-Benz OE A0019880325
- 15 wiring harness clips, to be used as Mercedes-Benz OE A1406980260
- 20 connecting clips, to be used as Mercedes-Benz OE A0019885081
- 35 connecting clips, to be used as Mercedes-Benz OE A0019884481

Item #
9043



Automotive Clip Assortment for Audi, VW | 160 pcs.

- 10 push-type clips, to be used as Audi OE 1H0867199A, VW OE 51481915964
- 10 trim clips, to be used as VW OE 1H086243, Audi OE 1H0868243B
- 10 rubber seal clips, to be used as Audi / VW / Skoda OE 1H0853585A
- 5 rubber seal clips, to be used as Audi / VW OE 3A0853575
- 20 rubber seal clips, to be used as Audi / VW OE 3B0853575
- 20 fastening clips, to be used as VW OE 3A0853575, Audi / VW OE 3A0853575A
- 10 fastening clips, to be used as Audi / VW OE 4A0853825C
- 15 hood rod clips, to be used as Audi / VW OE 1H0823397
- 15 push-type clips, to be used as Audi / VW OE 1H0819055C01C
- 10 door panel clips, to be used as VW OE 3B0838243, Audi / VW OE 3B0868243
- 20 protection strip clips, to be used as Audi / VW OE 357853575, Peugeot OE 6991W4
- 15 plastic clips, to be used as Audi / VW OE 4A0853825, Audi 4A0853825A



Item #	
9044	

Automotive Clip Assortment for VW, Audi, Volvo, Chrysler, Ford, Mercedes-Benz | 350 pcs.

- 40 push-type clips 10 x 7 x 5 mm, black, to be used as Mercedes-Benz OE A00099903492, Peugeot OE 790307216
- 30 push-type clips 13 x 14 x 8 mm, black, to be used as Mercedes-Benz OE A0009903792
- 40 push-type clips 12.3 x 17.5 x 8.4 mm, grey, to be used as VW / Audi OE N0385501, Peugeot 7814.24
- 20 push-type clips 16 x 12 x 8 mm, black, to be used as VW OE N16186729901C
- 30 push-type clips 9.9 x 10.7 x 6.1 mm, black, to be used as Mercedes-Benz OE A0009908492
- 20 push-type clips 18 x 16 x 7.4 mm, grey, to be used as Chrysler OE 25524005
- 25 push-type clips 15.8 x 11.1 x 6.3 mm, black, to be used as Ford OE 383142S
- 20 push-type clips 16 x 14 x 6 mm, black, to be used as Volvo OE 1268176
- 30 push-type clips 11.3 x 7 x 5 mm, white, to be used as GM OE 14005089
- 20 push-type clips 16 x 14 x 9 mm, black, to be used as Volvo OE 9133417
- 40 push-type clips 14.8 x 9.7 x 6.6 mm, black, to be used as VAG 8N0863788
- 35 push-type clips 10 x 12 x 5 mm, black, suitable for general use



Item #	
9045	

Automotive Clip Assortment for Toyota, Nissan, Mitsubishi | 350 pcs.

- 25 screw grommets, comparable to Fiat OE 83468473
- 40 screw nuts, comparable to Ford OE N379830S
- 40 4-pt. nut clips, comparable to Nissan OE 0128100501, Mazda OE 999100402
- 25 connecting clips, comparable to Mercedes-Benz OE A0019882981
- 30 4-pt. nut clips, comparable to Mitsubishi OE 9018905013
- 25 screw grommets, comparable to Mitsubishi OE MU480034
- 25 screw clips, comparable to Renault OE 7703081184
- 20 round nut clips, comparable to Toyota OE 9018906013
- 30 round nut clips, comparable to Nissan OE 128100231, Toyota OE 9018906001
- 30 4-pt. nut clips, comparable to Toyota OE 75521611000, Nissan OE 96706P0105
- 40 headlight nuts, comparable to GM OE 1370853, VW OE 441035555
- 20 screw grommets, comparable to Toyota OE 9018906157



Item #
9046



Automotive Clip Assortment for Toyota, Lexus | 360 pcs.

- 10 hood insulated clips, to be used as Toyota OE 9046709006
- 25 round nut clips, to be used as Nissan OE 128100231, Toyota OE 9018906001
- 40 4-pt. nut clips, to be used as Toyota OE 75521611000, Nissan OE 96706P0105
- 10 U-nut clips, to be used as Toyota OE 9017905060
- 25 door sill clips, to be used as Toyota OE 9046711063
- 25 moulding clips, to be used as Toyota OE 7539533030
- 20 push-type clips, to be used as Toyota OE 9046707138
- 35 push-type clips, to be used as Toyota OE 9046707117
- 30 connecting clips, to be used as Toyota OE 904679138
- 15 bumper clips, to be used as Toyota OE 9046709101
- 15 bumper clips, to be used as Toyota OE 9046709093
- 10 side moulding rubber connectors, to be used as Toyota OE 7504933010
- 20 door panel clips, to be used as Toyota OE 7503933060
- 20 moulding clips, to be used as Toyota OE 677711250
- 15 push-type clips, to be used as Toyota OE 9046709143
- 20 hood insulated clips, to be used as Toyota OE 9046708124
- 10 bumper push-type clips, to be used as Toyota OE 9046709096
- 15 hood insulated clips, to be used as Toyota OE 9046709050



Item #
9047



Automotive Clip Assortment for Renault | 300 pcs.

- 65 connecting clips, to be used as Fiat OE 14188380, Renault OE 7703077059
- 50 door moulding clips, to be used as Renault OE 7703077421
- 60 push-type clips, to be used as Renault OE 7703081184
- 50 fastening clips, universal
- 15 fastening clips
- 60 plastic nuts, to be used as Renault OE 7703074022, Mercedes-Benz OE A108980027



Item #	
9048	

Automotive Clip Assortment for Opel | 300 pcs.

- 40 moulding clips, to be used as Ford OE 1591426, Opel OE 174864
- 20 connecting clips, to be used as Opel OE 90218614
- 50 connecting clips (blue), to be used as Opel OE 2345959, Renault OE 7701053516, Audi OE 7L5853994
- 50 connecting clips (black), to be used as Opel OE 2240582
- 40 plastic nuts, to be used as Opel OE 180942
- 100 push-type clips, to be used as Peugeot OE 7814.24, VW OE N0385501



Item #	
9049	

Automotive Clip Assortment for Peugeot, Citroen | 345 pcs.

- 30 plastic nuts, to be used as Renault OE 7703074022, Mercedes-Benz OE A108980027
- 50 push-type clips, to be used as Volvo OE 947098, Mercedes-Benz OE A0009903492, Peugeot OE 790307216
- 20 trim clips, to be used as Peugeot & Citroen OE 856535
- 20 side molding clips, to be used as Audi OE 357853575, Peugeot OE 6991W4
- 15 plug in clips, to be used as Peugeot & Citroen OE 698317
- 20 connecting clips, suitable for general use on Citroen
- 25 connecting clips, to be used as Peugeot & Citroen OE 694143
- 35 connecting clips, to be used as Peugeot OE 743707
- 25 molding clips, to be used as Peugeot OE 699502
- 30 molding clips, to be used as Peugeot OE 6995X3
- 40 molding clips, to be used as Peugeot OE 69945
- 35 plug in clips, to be used as Fiat OE 14188380, Renault OE 7703077059



Item #	
9051	

Automotive Clip Assortment for Fiat | 308 pcs.

- 30 interior moulding clips, to be used as Fiat OE 14591784, Volvo OE 4292906
- 20 push-type clips, to be used as Fiat OE 1459487
- 25 push-type clips, to be used as Fiat OE 1300433650
- 8 connecting clips, to be used as Fiat OE 71717421
- 25 moulding clips, to be used as Fiat OE 82456515
- 25 moulding clips, to be used as Fiat OE 5757139
- 20 interior moulding clips, to be used as Fiat OE 1459387
- 25 moulding clips for Fiat, to be used as Lancia OE 14188282, Fiat OE 46306526, Alfa OE 60507749
- 25 moulding clips, to be used as Fiat OE 14591687
- 25 moulding clips, to be used as Fiat OE 1452387
- 30 screw grommets, to be used as Fiat OE 83468473
- 50 connecting clips, to be used as Fiat OE 7677865



Item #
9052



Automotive Clip Assortment for Volvo | 350 pcs.

- 25 push-type clips, to be used as Nissan OE 8099905N07, Toyota OE 9046707043, Volvo
- 30 interior moulding clips, to be used as Fiat OE 14591784, Volvo OE 4292906
- 20 bumper cover clips, to be used as Volvo OE 1268176
- 40 moulding clips, to be used as BMW OE 51131804205, Volvo
- 40 push-type clips, to be used as Volvo OE 947098, Mercedes-Benz OE A0009903492, Peugeot OE 790307216
- 40 body side moulding clips, to be used as Volvo OE 591740, VW OE 171583585
- 25 push-type clips, to be used as Nissan OE 6384801G00, Volvo
- 20 rocker panel clips, to be used as Volvo OE 9133417
- 40 hood insulated / radiator clips, to be used as Volvo OE 9133073
- 30 black fir tree clips, to be used as Volvo OE 3272075327462B
- 20 grey fir tree clips, to be used as Volvo OE 327462A
- 20 bonnet rod clips, to be used as Volvo OE 3923712



Item #
9053



Plastic Rivet Assortment | for GM, BMW, Chrysler, VW, Ford | 235 pcs.

- 15 plastic rivets, to be used as BMW OE 51717002953
- 25 plastic rivets, to be used as Chrysler OE 6500898
- 20 plastic rivets, to be used as Chrysler OE 25524005
- 20 radiator grille plastic rivets, to be used as Ford OE N804583S
- 15 plastic rivets, to be used as GM OE 14063981, Chrysler OE 6500911, Ford OE N8030433
- 15 plastic rivets, to be used as Chrysler OE 6503860, Ford OE N804675S
- 35 plastic rivets, to be used as GM OE 204655395, Chrysler OE 6004212
- 15 plastic rivets, to be used as GM OE 10036503
- 15 plastic rivets, to be used as GM OE 10109689
- 15 plastic rivets, to be used as GM OE 15506827
- 15 plastic rivets, to be used as GM OE 14070914
- 30 plastic rivets, to be used as VW OE 1758535570C, Chrysler OE 6503800



Item #	
9054	

Fir Tree Clip Assortment for GM, VW, Chrysler, BMW, Nissan Ford | 340 pcs.

- 30 fir tree fixings for radiator yoke, fender & bumper shield, to be used as Ford OE 388577S
- 30 fir tree fixings for fender & bumper shield
- 15 fir tree fixings for interior trim panel, to be used as Chrysler OE 6003423
- 15 fir tree fixings for door trim panel, to be used as VW OE N989022, Ford OE 385661, Chrysler OE 6003349
- 50 fir tree fixings for door weatherstrip, to be used as Chrysler OE 6502328, GM OE 20699808
- 10 fir tree fixings for bumper fascia, to be used as Ford OE N804379S
- 35 fir tree fixings for hood insulation, to be used as Ford OE F22Z16774A, Mazda OE 6508197AA
- 30 fir tree fixings for fender and bumper shield, to be used as GM OE 16674629, Ford OE N806113S
- 50 fir tree fixings for radiator grille, to be used as Nissan OE 0153301781
- 25 fir tree fixings for battery post cable shield, radiator side air baffle, to be used as BMW OE 52201964201, GM OE 10124502
- 20 fir tree fixings, to be used as VW OE N9020160H, Ford OE 6998849, BMW OE 514719044317, Opel OE 2207713
- 30 fir tree fixings for general use on many car brands, for e. g. trim panels, etc.



Item #	
9055	

Plastic Push-Type Clip Assortment for Mazda, Honda, Ford, Nissan & VW | 240 pcs.

- 30 push-type clips, comparable to Mazda OE 2042301, Chrysler OE MB345544
- 20 push-type clips, comparable to Honda OE 90675SB003, Nissan OE 75521611000
- 20 push-type clips, comparable to OE Ford OE 1007932, Nissan OE 6384401A00
- 40 push-type clips, comparable to Nissan OE 6686001W01, GM OE 94051933
- 20 push-type clips, comparable to Ford OE 1673046, GM OE 10139822, Chrysler OE 6508197AA
- 25 push-type clips, comparable to Ford OE 1007932, Chrysler OE 6502871
- 10 push-type clips, comparable to Audi / VW OE 1H0867199A, BMW OE 51481915964
- 15 push-type clips, comparable to Nissan OE 6387801E10
- 20 push-type clips, comparable to Ford OE W706713S300, Mazda OE NAU156145
- 15 push-type clips, comparable to Mercedes-Benz OE A1269900392
- 15 push-type clips, comparable to Mercedes-Benz OE A9904692
- 10 push-type clips, comparable to Audi / VW OE 1H0819055C01C



Item #
9057



Blind Rivets Assortment | aluminium | Ø 2.4 - 4.8 mm | 400 pcs.

- sorted
- rivet length: 6 mm
- dimensions 2.4 - 3.2 - 4 - 4.8 mm
- pin made of steel
- in plastic storage case



Item #
8058



O-Ring Assortment | Ø 3 - 50 mm | 419 pcs.

- acid, petrol, heat and oil resistant
- made of NBR, not suitable for drinking water
- 20 O-rings Ø 3 mm, thickness 1.5 mm
- 20 O-rings Ø 4.5 mm, thickness 2 mm
- 18 O-rings Ø 5 mm, thickness 2 mm
- 23 O-rings Ø 7 mm, thickness 1.5 mm
- 23 O-rings Ø 10 mm, thickness 1.5 mm
- 23 O-rings Ø 13 mm, thickness 1.5 mm
- 14 O-rings Ø 10 mm, thickness 2.5 mm
- 13 O-rings Ø 11 mm, thickness 2.5 mm
- 14 O-rings Ø 13 mm, thickness 2.5 mm
- 13 O-rings Ø 14 mm, thickness 2.5 mm
- 14 O-rings Ø 16 mm, thickness 2.5 mm
- 14 O-rings Ø 18 mm, thickness 2.5 mm
- 13 O-rings Ø 19 mm, thickness 2.5 mm
- 14 O-rings Ø 21 mm, thickness 2.5 mm
- 13 O-rings Ø 22 mm, thickness 2.5 mm
- 10 O-rings Ø 18 mm, thickness 3.5 mm
- 10 O-rings Ø 20 mm, thickness 3.5 mm
- 10 O-rings Ø 22 mm, thickness 3.5 mm
- 10 O-rings Ø 23.5 mm, thickness 3.5 mm
- 10 O-rings Ø 25 mm, thickness 3.5 mm
- 10 O-rings Ø 26.5 mm, thickness 3.5 mm
- 10 O-rings Ø 28 mm, thickness 3.5 mm
- 10 O-rings Ø 30 mm, thickness 3.5 mm
- 10 O-rings Ø 31 mm, thickness 3.5 mm
- 10 O-rings Ø 33 mm, thickness 3.5 mm
- 10 O-rings Ø 34.5 mm, thickness 3.5 mm
- 10 O-rings Ø 36 mm, thickness 3.5 mm
- 10 O-rings Ø 38 mm, thickness 3.5 mm
- 10 O-rings Ø 41 mm, thickness 3.5 mm
- 10 O-rings Ø 44 mm, thickness 3.5 mm
- 10 O-rings Ø 47 mm, thickness 3.5 mm
- 10 O-rings Ø 50 mm, thickness 3.5 mm



Consumables



Item #	Description
8045	O-Ring Assortment Ø 3 - 50 mm 419 pcs.
8045-LEER	Empty Case for BGS 8045

O-Ring Assortment | Inch Sizes | 419 pcs.

- acid, petrol, heat and oil resistant
- made of NBR, not suitable for drinking water
- 20 O-rings internal-Ø 1/8"
- 20 O-rings internal-Ø 3/16"
- 18 O-rings internal-Ø 1/4"
- 23 O-rings internal-Ø 5/16"
- 23 O-rings internal-Ø 3/8"
- 23 O-rings internal-Ø 1/2"
- 14 O-rings internal-Ø 3/8"
- 13 O-rings internal-Ø 7/16"
- 14 O-rings internal-Ø 1/2"
- 13 O-rings internal-Ø 9/16"
- 14 O-rings internal-Ø 5/8"
- 14 O-rings internal-Ø 11/16"
- 13 O-rings internal-Ø 3/4"
- 14 O-rings internal-Ø 13/16"
- 13 O-rings internal-Ø 7/8"
- 10 O-rings internal-Ø 3/4"
- 10 O-rings internal-Ø 13/16"
- 10 O-rings internal-Ø 7/8"
- 10 O-rings internal-Ø 5/16"
- 10 O-rings internal-Ø 1"
- 10 O-rings internal-Ø 1-1/16"
- 10 O-rings internal-Ø 1-1/8"
- 10 O-rings internal-Ø 1-3/16"
- 10 O-rings internal-Ø 1-1/4"
- 10 O-rings internal-Ø 1-5/16"
- 10 O-rings internal-Ø 1-3/8"
- 10 O-rings internal-Ø 1-7/16"
- 10 O-rings internal-Ø 1-1/2"
- 10 O-rings internal-Ø 1-5/8"
- 10 O-rings internal-Ø 1-3/4"
- 10 O-rings internal-Ø 1-7/8"
- 10 O-rings internal-Ø 2"



Item #
8061

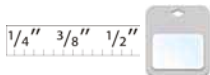

O-Ring Assortment | XXL | Ø 18 - 50 mm | 285 pcs.

- acid, petrol, heat and oil resistant
- in plastic storage case
- 10 O-rings 40 x 4 mm
- 5 O-rings 44 x 4 mm
- 5 O-rings 48 x 4 mm
- 5 O-rings 50 x 4 mm
- 20 O-rings 18 x 2 mm
- 20 O-rings 20 x 2 mm
- 20 O-rings 22 x 3 mm
- 20 O-rings 25 x 3 mm
- 15 O-rings 28.2 x 3 mm
- 15 O-rings 30.2 x 3 mm
- 10 O-rings 32.2 x 3 mm
- 10 O-rings 36.2 x 3 mm
- 15 O-rings 25 x 4 mm
- 10 O-rings 30 x 4 mm
- 10 O-rings 32 x 4 mm
- 10 O-rings 34 x 4 mm
- 15 O-rings 25 x 5 mm
- 15 O-rings 30 x 5 mm
- 10 O-rings 35 x 5 mm
- 10 O-rings 40 x 5 mm
- 5 O-rings 45 x 5 mm
- 5 O-rings 50 x 5 mm
- material: acrylic rubber (nbr)



Consumables

Item #
8105

O-Ring Assortment | Ø 3 - 22 mm | 225 pcs.

- ideal for DIY and workshop use
- in plastic storage case
- 20 O-rings internal Ø 3 mm, thickness: 1 mm
- 20 O-rings internal Ø 4 mm, thickness: 1 mm
- 20 O-rings internal Ø 4.5 mm, thickness: 2 mm
- 20 O-rings internal Ø 5 mm, thickness: 2 mm
- 20 O-rings internal Ø 6 mm, thickness: 2 mm
- 20 O-rings internal Ø 6 mm, thickness: 5 mm
- 20 O-rings internal Ø 6 mm, thickness: 3 mm
- 20 O-rings internal Ø 7 mm, thickness: 2 mm
- 20 O-rings internal Ø 8 mm, thickness: 2 mm
- 5 O-rings internal Ø 9 mm, thickness: 2 mm
- 5 O-rings internal Ø 10 mm, thickness: 2 mm
- 5 O-rings internal Ø 12 mm, thickness: 3 mm
- 5 O-rings internal Ø 13 mm, thickness: 3 mm
- 5 O-rings internal Ø 14 mm, thickness: 5 mm
- 5 O-rings internal Ø 17 mm, thickness: 5 mm
- 5 O-rings internal Ø 18 mm, thickness: 4 mm
- 5 O-rings internal Ø 20 mm, thickness: 2 mm
- 5 O-rings internal Ø 22 mm, thickness: 2 mm
- material: acrylic rubber (nbr)



Item #
8044



Seal Ring Assortment | Rubber and Fibreglass | 141 pcs.

- various gaskets manufactured from rubber and fibreglass
- for sanitary applications
- black sealing rings, rubber
- red sealing rings, reinforced paper fibre
- in plastic storage case
- 10 sealing rings 1/2" x 16 mm
- 5 sealing rings 3/8" x 8 mm
- 10 sealing rings 1/2" x 17 mm
- 10 sealing rings 3/4" 15 x 24 mm
- 10 sealing rings 3/4" 11 x 24 x 2 mm
- 5 sealing rings 1/2" 9 x 19 mm
- 5 sealing rings 1/2" x 10 mm
- 5 sealing rings 3/8" x 10 mm
- 10 sealing rings 3/4"
- 10 sealing rings 3/8" x 8 mm
- 10 sealing rings 21 x 17 mm
- 10 sealing rings 3/8"
- 10 sealing rings 1/2"
- 3 sealing rings 1-1/2" 27 x 38 mm
- 10 sealing rings 3/4" 16 x 24 mm
- 5 sealing rings 1"
- 3 sealing rings 1-1/4" 30 x 39 mm
- 10 sealing rings 1/2" 12 x 18 mm



Item #
8059



O-Ring Assortment | Ø 3 - 22 mm | 225 pcs.

- made from HNBR, specially for use on air conditioning lines
- in plastic storage case
- O-rings internal-Ø 3 mm
- O-rings internal-Ø 4 mm
- O-rings internal-Ø 4.5 mm
- O-rings internal-Ø 5 mm
- O-rings internal-Ø 6 mm
- O-rings internal-Ø 7 mm
- O-rings internal-Ø 8 mm
- O-rings internal-Ø 9 mm
- O-rings internal-Ø 10 mm
- O-rings internal-Ø 12 mm
- O-rings internal-Ø 13 mm
- O-rings internal-Ø 14 mm
- O-rings internal-Ø 17 mm
- O-rings internal-Ø 18 mm
- O-rings internal-Ø 20 mm
- O-rings internal-Ø 22 mm



Item #
8121



Seal Ring Assortment | Metal | with Rubber sealing Bead | 150 pcs.

- for oil drain plugs
- 10 metal sealing rings M6
- 10 metal sealing rings M8
- 10 metal sealing rings M10
- 20 metal sealing rings M12
- 20 metal sealing rings M14
- 20 metal sealing rings M18
- 20 metal sealing rings M16
- 20 metal sealing rings M20
- 10 metal sealing rings M22
- 10 metal sealing rings M24



Item #
9306

Assembly Tool Set | 220 mm | 2 pcs.

- straight and bent (45° and 90°) tips
- length: 220 mm

Item #		
8015		



O-Ring Hook Set | 5 pcs.

- incl. magnetic pick up tool

Item #	
8035	



Seal Removing Hook Set | 3 pcs.

- S-shaped hooks e. g. for loosening rotary shaft seals
- 90° hooks e. g. for loosening O-rings
- small hook tool

Item #	
8405	



Spring Washer Assortment | 1200 pcs.

- metric
- in plastic storage case
- 300 spring washers Ø 3 mm
- 300 spring washers Ø 4 mm
- 300 spring washers Ø 5 mm
- 150 spring washers Ø 6 mm
- 100 spring washers Ø 8 mm
- 50 spring washers Ø 10 mm
- surface finish: chrome plated

Item #
8053



Seal Ring Assortment | aluminium | 300 pcs.

- especially suitable for oil drain plugs
- suitable for all popular vehicles
- in plastic storage case
- 10 sealing rings 5 x 9 x 1.0 mm
- 10 sealing rings 8 x 14 x 1.5 mm
- 10 sealing rings 12 x 16 x 1.0 mm
- 10 sealing rings 14 x 20 x 1.5 mm
- 10 sealing rings 18 x 24 x 1.5 mm
- 10 sealing rings 22 x 30 x 1.5 mm
- 10 sealing rings 6 x 10 x 1.0 mm
- 10 sealing rings 9 x 14 x 1.0 mm
- 10 sealing rings 12 x 16 x 1.5 mm
- 10 sealing rings 14 x 20 x 2.0 mm
- 10 sealing rings 20 x 24.5 x 1.5 mm
- 10 sealing rings 22 x 29 x 1.5 mm
- 10 sealing rings 6 x 12 x 1.0 mm
- 10 sealing rings 10 x 14 x 1.0 mm
- 10 sealing rings 12 x 18 x 1.5 mm
- 10 sealing rings 16 x 20 x 1.5 mm
- 10 sealing rings 20 x 24.5 x 0.8 mm
- 10 sealing rings 24 x 32 x 2.0 mm
- 10 sealing rings 8 x 12 x 1.0 mm
- 10 sealing rings 10 x 14 x 1.5 mm
- 10 sealing rings 13 x 18 x 1.0 mm
- 10 sealing rings 16 x 22 x 1.5 mm
- 10 sealing rings 19 x 26 x 2.0 mm
- 10 sealing rings 26 x 34 x 2.0 mm
- 10 sealing rings 8 x 14 x 1.0 mm
- 10 sealing rings 10 x 16 x 1.0 mm
- 10 sealing rings 14 x 18 x 1.5 mm
- 10 sealing rings 18 x 22 x 1.5 mm
- 10 sealing rings 22 x 27 x 1.0 mm
- 10 sealing rings 28 x 36 x 2.0 mm

Item #
8143



Washer Assortment | 720 pcs.

- different sizes and shapes
- spring, star and lock shape
- in plastic storage case



Item #
8113



Injector Copper Ring Assortment | 551 pcs.

- 30 sealing rings Ø 15.0 x 8.0 x 1.5 mm, universal use
- 12 sealing rings Ø 15.0 x 7.0 x 1.5 mm, for Mercedes-Benz
- 30 sealing rings Ø 13.0 x 7.5 x 2.5 mm, for Renault
- 30 sealing rings Ø 15.0 x 7.5 x 1.5 mm, for Iveco Ford BMW MAN
- 30 sealing rings Ø 15.0 x 7.5 x 2.0 mm, for Iveco Ford BMW MAN
- 30 sealing rings Ø 15.45 x 8.0 x 2.0 mm, universal use
- 12 sealing rings Ø 13.5 x 10 x 2.0 mm, for Mazda
- 30 sealing rings Ø 15.5 x 7.5 x 2.5 mm, for Ford
- 12 sealing rings Ø 15.5 x 7.5 x 1.5 mm, for Land Rover
- 30 sealing rings Ø 15.0 x 7.5 x 3.0 mm, for Renault
- 12 sealing rings Ø 13.0 x 7.0 x 1.5 mm, for Deutz
- 30 sealing rings Ø 13.5 x 7.5 x 1.5 mm, for Ford
- 12 sealing rings Ø 15.0 x 7.5 x 1.5 mm, for Fiat
- 12 sealing rings Ø 15.5 x 7.5 x 1 mm, for MAN Rover
- 30 sealing rings Ø 16.5 x 7.5 x 2 mm, for Mercedes-Benz
- 12 sealing rings Ø 13.7 x 7.3 x 3 mm, for Kia
- 12 sealing rings Ø 13.7 x 7.3 x 2 mm, for Kia
- 50 sealing rings Ø 10 x 6.0 x 1.0 mm, for steel sealing rings
- 30 sealing rings Ø 15.8 x 7.5 x 3.0 mm, for brass sealing rings
- 20 T-shape plastic nozzles



Item #
8107

Seal Ring Assortment | Copper | 300 pcs.

- in plastic storage case
- 10 copper sealing rings \varnothing 5 x 9 mm, thickness: 1.0 mm
- 10 copper sealing rings \varnothing 6 x 10 mm, thickness: 1.0 mm
- 10 copper sealing rings \varnothing 6 x 12 mm, thickness: 1.0 mm
- 10 copper sealing rings \varnothing 8 x 12 mm, thickness: 1.0 mm
- 10 copper sealing rings \varnothing 8 x 14 mm, thickness: 1.0 mm
- 10 copper sealing rings \varnothing 8 x 14 mm, thickness: 1.5 mm
- 10 copper sealing rings \varnothing 9 x 14 mm, thickness: 1.0 mm
- 10 copper sealing rings \varnothing 10 x 14 mm, thickness: 1.0 mm
- 10 copper sealing rings \varnothing 10 x 14 mm, thickness: 1.5 mm
- 10 copper sealing rings \varnothing 10 x 16 mm, thickness: 1.0 mm
- 10 copper sealing rings \varnothing 12 x 16 mm, thickness: 1.0 mm
- 10 copper sealing rings \varnothing 12 x 16 mm, thickness: 1.5 mm
- 10 copper sealing rings \varnothing 12 x 18 mm, thickness: 1.5 mm
- 10 copper sealing rings \varnothing 13 x 18 mm, thickness: 1.0 mm
- 10 copper sealing rings \varnothing 14 x 18 mm, thickness: 1.5 mm
- 10 copper sealing rings \varnothing 14 x 20 mm, thickness: 1.5 mm
- 10 copper sealing rings \varnothing 14 x 20 mm, thickness: 2.0 mm
- 10 copper sealing rings \varnothing 16 x 20 mm, thickness: 1.5 mm
- 10 copper sealing rings \varnothing 16 x 22 mm, thickness: 1.5 mm
- 10 copper sealing rings \varnothing 18 x 22 mm, thickness: 1.5 mm
- 10 copper sealing rings \varnothing 18 x 24 mm, thickness: 1.5 mm
- 10 copper sealing rings \varnothing 20 x 24.5 mm, thickness: 1.5 mm
- 10 copper sealing rings \varnothing 20 x 24.5 mm, thickness: 0.8 mm
- 10 copper sealing rings \varnothing 19 x 26 mm, thickness: 2.0 mm
- 10 copper sealing rings \varnothing 22 x 27 mm, thickness: 1.5 mm
- 10 copper sealing rings \varnothing 22 x 29 mm, thickness: 1.5 mm
- 10 copper sealing rings \varnothing 24 x 29 mm, thickness: 1.5 mm
- 10 copper sealing rings \varnothing 24 x 32 mm, thickness: 2.0 mm
- 10 copper sealing rings \varnothing 26 x 34 mm, thickness: 2.0 mm
- 10 copper sealing rings \varnothing 28 x 36 mm, thickness: 2.0 mm
- material: copper



Item #
8142

Seal Ring Assortment | Copper | 150 pcs.

- for oil drain plugs
- in plastic storage case
- 10 O-rings each:
 - internal \varnothing 5 mm x external \varnothing 10 mm, thickness: 1 mm
 - internal \varnothing 6 mm x external \varnothing 10 mm, thickness: 1 mm
 - internal \varnothing 7 mm x external \varnothing 10 mm, thickness: 1 mm
 - internal \varnothing 8 mm x external \varnothing 12 mm, thickness: 1 mm
 - internal \varnothing 10 mm x external \varnothing 16 mm, thickness: 1 mm
 - internal \varnothing 10.5 mm x external \varnothing 17 mm, thickness: 1.5 mm
 - internal \varnothing 11 mm x external \varnothing 17 mm, thickness: 1.5 mm
 - internal \varnothing 12 mm x external \varnothing 20 mm, thickness: 1.5 mm
 - internal \varnothing 12.5 mm x external \varnothing 20 mm, thickness: 1.5 mm
 - internal \varnothing 14 mm x external \varnothing 18 mm, thickness: 1 mm
 - internal \varnothing 14 mm x external \varnothing 20 mm, thickness: 1.5 mm
 - internal \varnothing 15 mm x external \varnothing 20 mm, thickness: 2 mm
 - internal \varnothing 16 mm x external \varnothing 22 mm, thickness: 2 mm
 - internal \varnothing 16.5 mm x external \varnothing 24 mm, thickness: 2 mm
 - internal \varnothing 17.5 mm x external \varnothing 24 mm, thickness: 2 mm



Item #
8052



Injector Copper Ring Assortment | 150 pcs.

- for sealing of e.g. injectors on Common-Rail Diesel injection systems (CDI)
- 10 injectors copper ring assortments, external Ø 13.8 mm x internal Ø 7.3 mm, thickness: 1.4 mm
- 10 injectors copper ring assortments, external Ø 14.6 mm x internal Ø 7.5 mm, thickness: 1.3 mm
- 10 injectors copper ring assortments, external Ø 14.6 mm x internal Ø 7.5 mm, thickness: 3.0 mm
- 10 injectors copper ring assortments, external Ø 15.0 mm x internal Ø 7.0 mm, thickness: 2.0 mm
- 10 injectors copper ring assortments, external Ø 15.0 mm x internal Ø 7.5 mm, thickness: 1.0 mm
- 10 injectors copper ring assortments, external Ø 15.0 mm x internal Ø 7.5 mm, thickness: 1.5 mm
- 10 injectors copper ring assortments, external Ø 15.0 mm x internal Ø 7.5 mm, thickness: 2.0 mm
- 10 injectors copper ring assortments, external Ø 15.0 mm x internal Ø 7.5 mm, thickness: 2.5 mm
- 10 injectors copper ring assortments, external Ø 15.0 mm x internal Ø 7.5 mm, thickness: 3.0 mm
- 10 injectors copper ring assortments, external Ø 15.5 mm x internal Ø 7.5 mm, thickness: 2.0 mm
- 10 injectors copper ring assortments, external Ø 16.0 mm x internal Ø 7.5 mm, thickness: 1.5 mm
- 10 injectors copper ring assortments, external Ø 16.0 mm x internal Ø 7.5 mm, thickness: 1.7 mm
- 10 injectors copper ring assortments, external Ø 16.0 mm x internal Ø 7.5 mm, thickness: 2.0 mm
- 10 injectors copper ring assortments, external Ø 16.4 mm x internal Ø 7.5 mm, thickness: 2.0 mm
- 10 injectors copper ring assortments, external Ø 20.0 mm x internal Ø 9.4 mm, thickness: 0.9 mm



Item #	
8120	

O-Ring Assortment | Copper | Ø 6 - 20 mm | 95 pcs.

- hollow rings for better formability
- 10 O-rings Ø 8 mm
- 15 O-rings Ø 10 mm
- 15 O-rings Ø 12 mm
- 20 O-rings Ø 14 mm
- 20 O-rings Ø 16 mm
- 10 O-rings Ø 18 mm
- 5 O-rings Ø 20 mm



Item #	
9313	

Seal Ring Assortment | Copper | Inch Sizes | for Oil Drain Plugs | 75 pcs.

- suitable for oil drain plugs and hollow bolts
- in plastic storage case
- 5 cooper sealing rings $\text{Ø } 3/16'' \times 25/64''$, thickness: $1/32''$
- 5 cooper sealing rings $\text{Ø } 15/64'' \times 25/64''$, thickness: $1/32''$
- 5 cooper sealing rings $\text{Ø } 17/64'' \times 25/64''$, thickness: $1/32''$
- 5 cooper sealing rings $\text{Ø } 5/16'' \times 15/32''$, thickness: $1/32''$
- 5 cooper sealing rings $\text{Ø } 25/64'' \times 5/8''$, thickness: $1/32''$
- 5 cooper sealing rings $\text{Ø } 13/32'' \times 21/32''$, thickness: $3/64''$
- 5 cooper sealing rings $\text{Ø } 27/64'' \times 21/32''$, thickness: $3/64''$
- 5 cooper sealing rings $\text{Ø } 15/32'' \times 25/32''$, thickness: $3/64''$
- 5 cooper sealing rings $\text{Ø } 31/64'' \times 25/32''$, thickness: $3/64''$
- 5 cooper sealing rings $\text{Ø } 35/64'' \times 45/64''$, thickness: $1/32''$
- 5 cooper sealing rings $\text{Ø } 35/64'' \times 25/32''$, thickness: $3/64''$
- 5 cooper sealing rings $\text{Ø } 37/64'' \times 25/32''$, thickness: $5/64''$
- 5 cooper sealing rings $\text{Ø } 5/8'' \times 55/64''$, thickness: $5/64''$
- 5 cooper sealing rings $\text{Ø } 41/64'' \times 15/16''$, thickness: $5/64''$
- 5 cooper sealing rings $\text{Ø } 11/16'' \times 15/16''$, thickness: $5/64''$

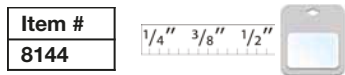

Seal Ring Assortment | Copper | Metric | for Oil Drain Plugs | 75 pcs.

- in a reusable universal box
- copper sealing ring $\text{Ø } 5.0 \times 10 \text{ mm}$, thickness: 1.0 mm
- copper sealing ring $\text{Ø } 6.0 \times 10 \text{ mm}$, thickness: 1.0 mm
- copper sealing ring $\text{Ø } 7.0 \times 10 \text{ mm}$, thickness: 1.0 mm
- copper sealing ring $\text{Ø } 8.0 \times 12 \text{ mm}$, thickness: 1.0 mm
- copper sealing ring $\text{Ø } 10.5 \times 17 \text{ mm}$, thickness: 1.5 mm
- copper sealing ring $\text{Ø } 11.0 \times 17 \text{ mm}$, thickness: 1.5 mm
- copper sealing ring $\text{Ø } 12.5 \times 20 \text{ mm}$, thickness: 1.5 mm
- copper sealing ring $\text{Ø } 14.0 \times 18 \text{ mm}$, thickness: 1.0 mm
- copper sealing ring $\text{Ø } 14.0 \times 20 \text{ mm}$, thickness: 1.5 mm
- copper sealing ring $\text{Ø } 15.0 \times 20 \text{ mm}$, thickness: 2.0 mm
- copper sealing ring $\text{Ø } 16.0 \times 22 \text{ mm}$, thickness: 2.0 mm
- copper sealing ring $\text{Ø } 16.5 \times 24 \text{ mm}$, thickness: 2.0 mm
- copper sealing ring $\text{Ø } 17.5 \times 24 \text{ mm}$, thickness: 2.0 mm

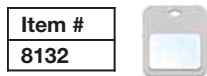

Rubber Grommet Assortment | Metric | 180 pcs.

- is used for cable protection when laying through holes in sheet metal or plastic parts
- in plastic storage case
- 5 rubber grommets bore Ø 22 mm, cable Ø 15 mm, outer Ø 26 mm
- 5 rubber grommets bore Ø 15.5 mm, cable Ø 12 mm, outer Ø 19 mm
- 5 rubber grommets bore Ø 28 mm, cable Ø 17 mm, outer Ø 32 mm
- 20 rubber grommets bore Ø 12 mm, cable Ø 11 mm, outer Ø 15 mm
- 25 rubber grommets bore Ø 11 mm, cable Ø 9 mm, outer Ø 15 mm
- 40 rubber grommets bore Ø 10 mm, cable Ø 6 mm, outer Ø 13 mm
- 40 rubber grommets bore Ø 7.5 mm, cable Ø 5 mm, outer Ø 10 mm
- 40 rubber grommets bore Ø 6 mm, cable Ø 3 mm, outer Ø 8 mm



Item #	
8125	

Rubber Grommet Assortment | Inch Sizes | 180 pcs.

- 40 rubber grommet 5/16"
- 40 rubber grommet 1/4"
- 40 rubber grommet 3/8"
- 20 rubber grommet 1/2"
- 25 rubber grommet 7/16"
- 5 rubber grommet 5/8"
- 5 rubber grommet 7/8"
- 5 rubber grommet 1"
- in plastic storage case

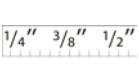

Item #	
8112	

Splint Pin Assortment | Ø 1.6 - 4.0 mm | 555 pcs.

- straight type
- assorted
- in plastic storage case
- splints 1.6 x 25mm - 2.4 x 25mm - 2.4 x 33 mm - 3.2 x 32 mm - 3.2 x 50 mm - 4.0 x 64 mm



Item #	
8048	

Snap Ring Assortment | Ø 2.4 - 4.0 mm | 150 pcs.

- in plastic storage case
- 42 snap rings Ø 2.4 x 31 mm
- 30 snap rings Ø 2.0 x 33 mm
- 25 snap rings Ø 2.0 x 40 mm
- 25 snap rings Ø 2.8 x 42 mm
- 20 snap rings Ø 3.5 x 45 mm
- 8 snap rings Ø 4.0 x 75 mm
- surface finish: chrome plated

Item #
8043



Fastening Bolt Set | 60 pcs.

- 4 fastening bolts, hole Ø 2.5 mm, 2.5 x 25 mm
- 4 fastening bolts, hole Ø 2.5 mm, 6 x 25 mm
- 3 fastening bolts, hole Ø 2.5 mm, 6 x 30 mm
- 4 fastening bolts, hole Ø 2.5 mm, 6 x 40 mm
- 3 fastening bolts, hole Ø 2.5 mm, 6 x 45 mm
- 3 fastening bolts, hole Ø 2.5 mm, 6 x 50 mm
- 3 fastening bolts, hole Ø 2.5 mm, 6 x 60 mm
- 3 fastening bolts, hole Ø 2.5 mm, 6 x 65 mm
- 3 fastening bolts, hole Ø 3.0 mm, 8 x 25 mm
- 3 fastening bolts, hole Ø 3.0 mm, 8 x 30 mm
- 4 fastening bolts, hole Ø 3.0 mm, 8 x 40 mm
- 3 fastening bolts, hole Ø 3.0 mm, 8 x 45 mm
- 2 fastening bolts, hole Ø 3.0 mm, 8 x 50 mm
- 2 fastening bolts, hole Ø 3.0 mm, 8 x 60 mm
- 1 fastening bolt, hole Ø 3.0 mm, 8 x 65 mm
- 2 fastening bolts, hole Ø 3.0 mm, 8 x 70 mm
- 4 fastening bolts, hole Ø 4.0 mm, 10 x 25 mm
- 3 fastening bolts, hole Ø 4.0 mm, 10 x 40 mm
- 2 fastening bolts, hole Ø 4.0 mm, 10 x 50 mm
- 2 fastening bolts, hole Ø 4.0 mm, 12 x 40 mm
- 2 fastening bolts, hole Ø 4.0 mm, 12 x 50 mm

Item #
8137



Linchpin Assortment | 50 pcs.

- in plastic storage case
- galvanized, zinc coated
- 16 lynch pins 4.5 mm
- 18 lynch pins 6.0 mm
- 6 lynch pins 8.0 mm
- 10 lynch pins 11.0 mm
- surface finish: galvanised, electroplated

Item #
8087



Roll Pin Assortment | 450 pcs.

- metric
- in plastic storage case
- all standard sizes assorted
- 30 roll pins 3 x 40 mm
- 40 roll pins 4 x 30 mm
- 20 roll pins 4 x 40 mm
- 30 roll pins 5 x 40 mm
- 30 roll pins 4 x 50 mm
- 5 roll pins 5 x 50 mm
- 5 roll pins 6 x 50 mm
- 5 roll pins 5 x 60 mm
- 4 roll pins 6 x 60 mm
- 4 roll pins 8 x 60 mm
- 4 roll pins 7 x 70 mm
- 3 roll pins 8 x 80 mm
- 4 roll pins 8 x 50 mm
- 2 roll pins 10 x 80 mm
- 6 roll pins 10 x 400 mm
- 8 roll pins 8 x 40 mm
- 20 roll pins 6 x 40 mm
- 80 roll pins 3 x 30 mm
- 150 roll pins 2 x 20 mm



Item #
8054



Feather Key Assortment | 60 pcs.

- for form-fitting connection of hubs on shafts
- 4 feather keys 3 x 3 x 20 mm
- 4 feather keys 3 x 3 x 25 mm
- 5 feather keys 5 x 5 x 20 mm
- 5 feather keys 5 x 5 x 25 mm
- 5 feather keys 5 x 5 x 30 mm
- 5 feather keys 6 x 6 x 20 mm
- 5 feather keys 6 x 6 x 30 mm
- 5 feather keys 6 x 6 x 40 mm
- 5 feather keys 8 x 7 x 30 mm
- 5 feather keys 8 x 7 x 40 mm
- 5 feather keys 10 x 8 x 30 mm
- 5 feather keys 10 x 8 x 40 mm
- 5 feather keys 12 x 8 x 40 mm



Item #
8141



Spring Assortment | Compression and Extension Spring | 200 pcs.

- extension and compression springs
- in plastic storage cas
- compression springs 5.5 x 17.5 mm
- compression springs 5.5 x 38.0 mm
- compression springs 6.5 x 10.0 mm
- compression springs 7.0 x 12.5 mm
- compression springs 7.0 x 19.0 mm
- compression springs 9.0 x 35 mm
- compression springs 9.5 x 16 mm
- compression springs 9.5 x 19 mm
- extension springs 4.0 x 79.5 mm
- extension springs 4.5 x 44.5 mm
- extension springs 5.0 x 20.5 mm
- extension springs 5.5 x 25.5 mm
- extension springs 6.5 x 22.0 mm
- extension springs 7.0 x 98.0 mm
- extension springs 7.0 x 51.0 mm
- extension springs 8.0 x 28.5 mm
- extension springs 8.0 x 31.5 mm
- extension springs 8.0 x 44.5 mm
- extension springs 8.5 x 36.5 mm
- extension springs 8.5 x 47 mm



Item #
8047



VDE Insulating Tape Assortment | 6 pcs.

- length 5 m x width 19 mm
- colours: 2 black, 2 red, 1 yellow, 1 white
- flexible and highly adhesive
- VDE approved



Item #
80836



VDE Insulating Tape Roll | 15 m

- black
- 0.15 mm x 15 mm x 15 m
- core diameter: 50 mm
- VDE approved



Item #
3025



PTFE Seal Tape | 10 m | 2 pcs.

- for the sealing of compressed air and water pipe connections
- suitable for sanitary and pneumatic fittings



Item #
8582



Cable Tie Set | white

- material: nylon
- colour: weiß



Item #	Description
1788	Cable Tie Set white 4.8 x 250 mm 50 pcs.
80876	Cable Tie Set white 4.8 x 300 mm 50 pcs.
80878	Cable Tie Set white 8.0 x 400 mm 30 pcs.
80881	Cable Tie Set white 8.0 x 600 mm 20 pcs.

Cable Tie Set | white | Various Sizes | 250 pcs.

- suitable for binding of cables, hoses ect.
- 160 cable ties 100 x 2.5 mm
- 40 cable ties 200 x 4.6 mm
- 10 cable ties 200 x 7.5 mm
- 30 cable ties 300 x 4.7 mm
- 10 cable ties 300 x 7.8 mm
- material: nylon
- colour: white

Item #
80874



Cable Lug Assortment | 360 pcs.

- 20 crimping sleeves, red, 0.25 - 1.5 mm²
- 30 crimping sleeves, blue, 1.5 - 2.5 mm²
- 15 crimping sleeves, yellow, 4 - 6 mm²
- 25 flat plugs partly insulated, blue, 1.5 - 2.5 mm²
- 25 flat plug sleeves partly insulated, blue, 1.5 - 2.5 mm²
- 5 round connectors partly insulated, blue, 1.5 - 2.5 mm²
- 5 round connector sleeves fully insulated, blue, 1.5 - 2.5 mm²
- 30 ring cable lugs partly insulated, blue, Ø 5 mm
- 20 ring cable lugs partly insulated, blue, Ø 6 mm
- 20 ring cable lugs partly insulated, blue, Ø 10 mm
- 20 ring cable lugs partly insulated, yellow, Ø 5 mm
- 15 ring cable lugs partly insulated, yellow, Ø 6 mm
- 15 ring cable lugs partly insulated, yellow, Ø 10 mm
- 30 fork cable lugs partly insulated, blue, Ø 5 mm
- 20 ring fork cable lugs partly insulated, yellow, Ø 5 mm
- 10 flat plugs fully insulated, blue, 1.5 - 2.5 mm²
- 10 flat plugs sleeve fully insulated, blue, 1.5 - 2.5 mm²
- 20 plug sleeves fully insulated, red, 0.25 - 1.5 mm²
- 25 mini plugs partly insulated, blue, 1.5 - 2.5 mm²



Item #
14110



Cable Lug Set | 160 pcs.

- 12 crimping sleeves, red, 0.25 - 1.5 mm²
- 18 crimping sleeves, blue, 1.5 - 2.5 mm²
- 12 crimping sleeves, yellow, 4 - 6 mm²
- 10 flat plugs partly insulated, blue, 1.5 - 2.5 mm²
- 5 flat plugs partly insulated, yellow, 4 - 6 mm²
- 10 flat plug sleeves partly insulated, blue, 1.5 - 2.5 mm²
- 5 flat plug sleeves, partly insulated, yellow, 4 - 6 mm²
- 4 crimp connectors, red, 0.25 - 1.5 mm²
- 4 crimp connectors, blue, 1.5 - 2.5 mm²
- 10 round plugs partly insulated, blue, 1.5 - 2.5 mm²
- 10 round plugs sleeve fully insulated, blue, 1.5 - 2.5 mm²
- 4 ring cable lugs, partly insulated, yellow, Ø 5 mm
- 4 ring cable lugs, partly insulated, yellow, Ø 8 mm
- 4 ring cable lugs, partly insulated, yellow, Ø 10 mm
- 10 ring cable lugs, partly insulated, blue, Ø 4 mm
- 10 ring cable lugs, partly insulated, blue, Ø 5 mm
- 10 ring cable lugs, partly insulated, blue, Ø 6 mm
- 10 fork cable lugs, partly insulated, blue, Ø 4 mm
- 8 ring cable lugs, partly insulated, red, Ø 4 mm



Item #
14105



Cable Lug Assortment | 30 pcs.

- spare cable lug assortment for tool box BGS 15501



Item #
15501-2

Insulated Ferrules Assortment | 685 pcs.

- in practical re-usable box
- 50 ferrules for cable diameter 0.5 mm²
- 50 ferrules for cable diameter 0.75 mm²
- 100 ferrules for cable diameter 1.0 mm²
- 250 ferrules for cable diameter 1.5 mm²
- 150 ferrules for cable diameter 2.5 mm²
- 50 ferrules for cable diameter 4.0 mm²
- 25 ferrules for cable diameter 6.0 mm²
- 10 ferrules for cable diameter 10.0 mm²

Item #	
14120	



Branch Connector Set | 50 pcs.

- clamping made of highly-conductive material
- polyamide insulation (nylon) provides the highest quality
- temperature range: 60 to 110 °C (shortly up to 130 °C)
- in plastic storage case

Item #	
80757	



Soldering Connector Set | with Shrink Tube | 9 pcs.

- clear heat-shrinkable sleeve with coloured ring
- allows soldering and shrinking at the same time
- includes 3 pieces each of the following sizes:
 - 2.7 mm inner diameter, 40 mm length
 - 4.5 mm inner diameter, 40 mm length
 - 6.8 mm inner diameter, 40 mm length
- temperature range: -55 - 125 °C

Item #	
85220	



Rivet Nuts Assortment | Galvanized Steel | 150 pcs.

- in practical re-usable universal box
- 40 rivet nuts M3 x 9 mm
- 35 rivet nuts M4 x 11 mm
- 25 rivet nuts M5 x 13 mm
- 25 rivet nuts M6 x 15 mm
- 15 rivet nuts M8 x 18 mm
- 10 rivet nuts M10 x 21 mm
- material: steel
- surface finish: galvanised

Item #	
14126	



Rivet Nuts Assortment | Aluminium | 150 pcs.

- aluminium
- in practical re-usable universal box
- 40 rivet nuts M3 x 9 mm
- 35 rivet nuts M4 x 11 mm
- 25 rivet nuts M5 x 13 mm
- 25 rivet nuts M6 x 15 mm
- 15 rivet nuts M8 x 18 mm
- 10 rivet nuts M10 x 21 mm

Item #
14127



Hose Clamp Set | Stainless | on Display Board | 111 pcs.

- rust-proof
- supplied in standing display, can also be mounted on walls
- clamp drive: hexagon 7 mm
- 10 hose clamps, each width: 9 mm: 8 - 12 / 10 - 16 / 12 - 20 / 16 - 25 / 20 - 32 / 25 - 40 / 30 - 45 mm
- 10 hose clamps, each width: 12 mm: 32 - 50 / 40 - 60 / 50 - 70 / 60 - 80 mm
- incl. 7 mm hexagon screwdriver

Item #	Description
8095	Hose Clamp Set Stainless on Display Board 111 pcs.
8095-8x12	Hose Clamps Stainless 8 x 12 mm 10 pcs.
8095-10x16	Hose Clamps Stainless 10 x 16 mm 10 pcs.
8095-12x20	Hose Clamps Stainless 12 x 20 mm 10 pcs.
8095-16x25	Hose Clamps Stainless 16 x 25 mm 10 pcs.
8095-20x32	Hose Clamps Stainless 20 x 32 mm 10 pcs.
8095-25x40	Hose Clamps Stainless 25 x 40 mm 10 pcs.
8095-30x45	Hose Clamps Stainless 30 x 45 mm 10 pcs.
8095-32x50	Hose Clamps Stainless 32 x 50 mm 10 pcs.
8095-40x60	Hose Clamps Stainless 40 x 60 mm 10 pcs.
8095-50x70	Hose Clamps Stainless 50 x 70 mm 10 pcs.
8095-60x80	Hose Clamps Stainless 60 x 80 mm 10 pcs.



Hose Clamp Assortment | Ø 16 - 40 mm | 26 pcs.

- in plastic storage case
- 8 hose clamps Ø 16 mm
- 6 hose clamps Ø 22 mm
- 4 hose clamps Ø 25 mm
- 2 hose clamps Ø 28 mm
- 2 hose clamps Ø 35 mm
- 4 hose clamps Ø 40 mm

Item #
8055



Hose Clamp Assortment | Ø 6 - 16 mm | 30 pcs.

- metric steel hose clamps
- suitable for oil, compressed air and fuel hoses
- 7 hose clamps Ø 6-8 mm
- 7 hose clamps Ø 7-9 mm
- 5 hose clamps Ø 8-10 mm
- 5 hose clamps Ø 9-11 mm
- 3 hose clamps Ø 10-12 mm
- 3 hose clamps Ø 14-16 mm



Item #
9476



Stainless Steel Hose Clamp Assortment | Ø 5.8 - 21 mm | 170 pcs.

- for use with BGS 161, 8359
- 20 hose clamps Ø 5.8 - 7.0 mm
- 20 hose clamps Ø 7.3 - 9.0 mm
- 20 hose clamps Ø 8.8 - 10.5 mm
- 20 hose clamps Ø 10.8 - 13.3 mm
- 20 hose clamps Ø 12.0 - 14.5 mm
- 20 hose clamps Ø 12.3 - 14.8 mm
- 20 hose clamps Ø 14.5 - 17.0 mm
- 15 hose clamps Ø 16.0 - 19.2 mm
- 15 hose clamps Ø 17.8 - 21.0 mm



Item #
14115

Hose Clamp Assortment, rubberized | Ø 6 - 16 mm | 18 pcs.

- 8 rubberized hose clamps Ø 6 mm
- 4 rubberized hose clamps Ø 8 mm
- 2 rubberized hose clamps Ø 10 mm
- 2 rubberized hose clamps Ø 13 mm
- 2 rubberized hose clamps Ø 16 mm
- surface finish: galvanised



Item #
14145



Handle Hose Clamps Assortment | 26 pcs.

- for tool free assembly
- 10 handle hose clamps 13 mm or 1/2"
- 6 handle hose clamps 16 mm or 5/8"
- 6 handle hose clamps 19 mm or 3/4"
- 2 handle hose clamps 22 mm or 7/8"
- 2 handle hose clamps 25 mm or 1"



Item #
80859



Hose Connector Assortment | Fuel Resistant | 100 pcs.

- for interconnecting hoses, such as vacuum hoses, return lines, etc.
- material: POM (polyoxymethylen)
- fuel and oil resistant
- 25 T-terminals:
 - 10 pcs. x 3 mm
 - 5 pcs. x 5 mm
 - 3 pcs. x 6 mm
 - 3 pcs. x 8 mm
 - 2 pcs. x 10 mm
 - 2 pcs. x 12 mm
- 25 x L-terminals
 - 10 pcs. x 3 mm
 - 5 pcs. x 5 mm
 - 3 pcs. x 6 mm
 - 3 pcs. x 8 mm
 - 2 pcs. x 10 mm
 - 2 pcs. x 12 mm
- 25 I-terminals
 - 10 pcs. x 3 mm
 - 5 pcs. x 5 mm
 - 3 pcs. x 6 mm
 - 3 pcs. x 8 mm
 - 2 pcs. x 10 mm
 - 2 pcs. x 12 mm
- 25 Y-terminals
 - 10 pcs. x 3 mm
 - 5 pcs. x 5 mm
 - 3 pcs. x 6 mm
 - 3 pcs. x 8 mm
 - 2 pcs. x 10 mm
 - 2 pcs. x 12 mm



Consumables



Item #	Description
8790	Hose Connector Assortment Fuel Resistant 100 pcs.
8790-3	Hose Connector Assortment Fuel Resistant 3 mm 8 pcs.
8790-5	Hose Connector Assortment Fuel Resistant 3 mm 5 pcs.
8790-6	Hose Connector Assortment Fuel Resistant 6 mm 8 pcs.
8790-8	Hose Connector Assortment Fuel Resistant 8 mm 8 pcs.
8790-10	Hose Connector Assortment Fuel Resistant 10 mm 8 pcs.

Grease Nipple Assortment | 110 pcs.

- straight, 45° and 90° angled type
- 60 grease nipples M6 x 1.00, straight
- 5 grease nipples M6 x 1.00, 45°
- 5 grease nipples M6 x 1.00, 90°
- 10 grease nipples M8 x 1.25, straight
- 5 grease nipples M8 x 1.25, 45°
- 5 grease nipples M8 x 1.25, 90°
- 10 grease nipples M10 x 1.50, straight
- 5 grease nipples M10 x 1.50, 45°
- 5 grease nipples M10 x 1.50, 90°
- material: carbon steel (A3)
- surface finish: galvanised



Item #	
8065	

Grease Nipple Assortment | Metric / Inch Sizes | 70 pcs.

- straight, 45° and 90° angled type
- 20 grease nipples 1/4" x 28 mm, straight
- 5 grease nipples 1/4" x 28 mm, 45°
- 5 grease nipples 1/4" x 28 mm, 90°
- 10 grease nipples 1/8" x 27 mm, straight
- 5 grease nipples 1/8" x 27 mm, 45°
- 5 grease nipples 1/8" x 27 mm, 90°
- 10 grease nipples M6 x 1.0 mm, straight
- 5 grease nipples M8 x 1.0 mm, straight
- 5 grease nipples M10 x 1.0 mm, straight
- material: carbon steel (A3)
- surface finish: galvanised



Item #	
8065-1	

Screw and U-Type Cushion Assortment | 170 pcs.

- in plastic storage case
- 40 screws 3 x 8 mm
- 20 screws 4 x 16 mm
- 15 screws 5 x 12 mm
- 10 screws 6 x 20 mm
- 85 mudguard clips/body nuts in various sizes and shapes



Item #	
8114	

Wing Nut Assortment | 75 pcs.

- metric
- sizes: M5 x 0.8 - M6 x 1.0 - M8 x 1.25
- in plastic storage case
- surface finish: galvanised

Item #
8133



Hexagon Nut Assortment | Self-Locking | 146 pcs.

- metric with nylon insert
- in plastic storage case
- 35 hexagon nuts, self-locking, M4
- 35 hexagon nuts, self-locking, M5
- 25 hexagon nuts, self-locking, M6
- 25 hexagon nuts, self-locking, M8
- 16 hexagon nuts, self-locking, M10
- 10 hexagon nuts, self-locking, M12
- surface finish: chrome plated

Item #
8135



Screw Hook Assortment | 151 pcs.

- open & closed type
- in plastic storage case
- open type: 2.5 x 40 - 4 x 60 - 4.8 x 75 mm
- closed type: 2.2 x 25 - 4.3 x 45 - 4.8 x 50 mm
- surface finish: galvanised

Item #
8136



Cap Hex Nut Assortment | 150 pcs

- according to DIN 1587
- 30 cap nuts M3
- 30 cap nuts M4
- 30 cap nuts M5
- 30 cap nuts M6
- 20 cap nuts M8
- 10 cap nuts M10
- material: steel
- surface finish: nickel plated

Item #
14130



Grub Screw Assortment | 160 pcs.

- made of steel
- according to DIN 913
- security bolts with coarse thread:
 - 15 grub screws M3 x 5 mm
 - 15 grub screws M4 x 5 mm
 - 20 grub screws M6 x 6 mm
 - 10 grub screws M6 x 10 mm
 - 20 grub screws M8 x 10 mm
 - 10 grub screws M5 x 6 mm
 - 10 grub screws M8 x 12 mm
 - 10 grub screws M10 x 10 mm
 - 10 grub screws M10 x 12 mm
- security bolts with fine thread:
 - 15 grub screws M6 x 6 mm
 - 15 grub screws M8 x 10 mm
 - 10 grub screws M10 x 10 mm



Item #	
14135	

Shrink Tube Assortment | black | 127 pcs.

- fast repair, protects cables from humidity and corrosion
- shrink ratio 2:1
- in plastic storage case

- various assorted sizes:
- Ø 2 mm, length 40 mm
 - Ø 2.5 mm, length 40 mm
 - Ø 3.5 mm, length 40 mm
 - Ø 5 mm, length 40 mm
 - Ø 7 mm, length 80 mm
 - Ø 10 mm, length 80 mm
 - Ø 13 mm, length 85 mm



Item #	
8042	

Shrink Tube Assortment | coloured | 100 pcs.

- fast repair, protects cables from humidity and corrosion
- shrinkage ratio approx. 2:1
- in plastic storage case
- 30 shrink tubings Ø 1.5 mm, length: 100 mm
- 30 shrink tubings Ø 2.5 mm, length: 100 mm
- 20 shrink tubings Ø 4.0 mm, length: 100 mm
- 10 shrink tubings Ø 6.0 mm, length: 100 mm
- 6 shrink tubings Ø 10.0 mm, length: 100 mm
- 4 shrink tubings Ø 13.0 mm, length: 100 mm



Item #	
8123	

Shrink Tube Assortment | red / black | 150 pcs.

- fast repair, protects cables from humidity and corrosion
- shrink rate 2:1
- 40 shrink tubings Ø 2.0 mm, length: 30 mm
- 40 shrink tubings Ø 2.5 mm, length: 60 mm
- 20 shrink tubings Ø 3.5 mm, length: 60 mm
- 16 shrink tubings Ø 5.0 mm, length: 60 mm
- 10 shrink tubings Ø 6.0 mm, length: 60 mm
- 8 shrink tubings Ø 8.0 mm, length: 100 mm
- 8 shrink tubings Ø 10.0 mm, length: 100 mm
- 8 shrink tubings Ø 13.0 mm, length: 100 mm
- in assortment box



Item #
9404



Shrink Tube Assortment | transparent | 150 pcs.

- fast repair, protects cables from humidity and corrosion
- shrink rate 2:1
- 50 shrink tubings Ø 1.5 mm, length: 100 mm
- 30 shrink tubings Ø 2.5 mm, length: 100 mm
- 30 shrink tubings Ø 3.0 mm, length: 100 mm
- 20 shrink tubings Ø 5.0 mm, length: 100 mm
- 10 shrink tubings Ø 6.0 mm, length: 100 mm
- 10 shrink tubings Ø 10.0 mm, length: 100 mm
- in assortment box



Item #
9405



Car Fuse Assortment | MINI | 121 pcs.

- fuses colour-coded according to size
- in plastic storage case
- 20 fuses MINI 5 A
- 20 fuses MINI 10 A
- 20 fuses MINI 15 A
- 20 fuses MINI 20 A
- 20 fuses MINI 25 A
- 20 fuses MINI 30 A
- "MINI" fuse puller



Item #
8109



Car Fuse Assortment | Standard | 92 pcs.

- fuses colour-coded according to size
- in plastic storage case
- 15 standard fuses 5 A
- 15 standard fuses 10 A
- 15 standard fuses 15 A
- 15 standard fuses 20 A
- 15 standard fuses 25 A
- 15 standard fuses 30 A
- voltage tester 6 - 24 V
- fuse puller



Item #	
8124	

Car Fuse Assortment | 97 pcs.

- fuses colour-coded according to size
- in plastic storage case
- 12 car fuses 3 A
- 12 car fuses 5 A
- 12 car fuses 7.5 A
- 12 car fuses 10 A
- 12 car fuses 15 A
- 12 car fuses 20 A
- 12 car fuses 25 A
- 12 car fuses 30 A
- incl. fuse puller



Item #	
8126	

Car Fuse Assortment | Maxi | 24 pcs.

- dimensions: 30 x 35 mm
- contact distance: 8 mm
- 3 fuses 20 A
- 3 fuses 30 A
- 3 fuses 40 A
- 3 fuses 50 A
- 3 fuses 60 A
- 3 fuses 70 A
- 3 fuses 80 A
- 3 fuses 100 A



Item #	
8127	

External Circlip Assortment | Ø 3 - 32 mm | 300 pcs.

- in plastic storage case
- 20 circlips Ø 3 mm
- 10 circlips Ø 4 mm
- 15 circlips Ø 5 mm
- 25 circlips Ø 6 mm
- 15 circlips Ø 8 mm
- 20 circlips Ø 9 mm
- 15 circlips Ø 11 mm
- 15 circlips Ø 12 mm
- 25 circlips Ø 13 mm
- 15 circlips Ø 14 mm
- 20 circlips Ø 15 mm
- 25 circlips Ø 19 mm
- 15 circlips Ø 20 mm
- 20 circlips Ø 22 mm
- 15 circlips Ø 25 mm
- 15 circlips Ø 26 mm
- 10 circlips Ø 28 mm
- 5 circlips Ø 32 mm
- material: manganese steel (65)



Item #
8046



Internal Circlip Assortment | Ø 3 - 32 mm | 300 pcs.

- in plastic storage case
- 20 circlips Ø 3 mm
- 10 circlips Ø 4 mm
- 15 circlips Ø 5 mm
- 25 circlips Ø 6 mm
- 15 circlips Ø 8 mm
- 20 circlips Ø 9 mm
- 15 circlips Ø 11 mm
- 15 circlips Ø 12 mm
- 25 circlips Ø 13 mm
- 15 circlips Ø 14 mm
- 20 circlips Ø 15 mm
- 25 circlips Ø 19 mm
- 15 circlips Ø 20 mm
- 20 circlips Ø 22 mm
- 15 circlips Ø 25 mm
- 15 circlips Ø 26 mm
- 10 circlips Ø 28 mm
- 5 circlips Ø 32 mm
- material: manganese steel (65)



Item #
8049



Metric E-Clip Assortment | 1.5 - 22 mm | 300 pcs.

- made of spring steel
- black phosphated
- in plastic storage case
- E-ring circlips 30 x 1.5 mm
- E-ring circlips 30 x 3 mm
- E-ring circlips 40 x 5 mm
- E-ring circlips 50 x 6 mm
- E-ring circlips 50 x 10 mm
- E-ring circlips 40 x 12 mm
- E-ring circlips 20 x 15 mm
- E-ring circlips 20 x 19mm
- E-ring circlips 20 x 22 mm
- material: spring steel
- surface finish: black phosphated



Item #
8039



Snap Hook Assortment | 20 pcs.

- 6 snap hooks 36 x 17 mm, Ø 3.5 mm
- 4 snap hooks 40 x 20 mm, Ø 4.0 mm
- 4 snap hooks 49 x 23 mm, Ø 5.0 mm
- 2 snap hooks 58 x 27 mm, Ø 6.0 mm
- 2 snap hooks 65 x 31 mm, Ø 7.0 mm
- 2 snap hooks 75 x 34 mm, Ø 8.0 mm



Item #
8078



Grommet Installation Assortment | 103 pcs.

- 50 grommets, inner diameter 11.5 mm, outer diameter 24 mm
- 3 pcs. installation tool
- universally suitable for many interior repair and DIY work, not suitable for outdoor use
- in plastic storage case



Item #
8111



Woodruff Key Assortment | 80 pcs.

- in plastic storage case
- each 10 woodruff keys in the following sizes:
 - 3 x 5 x 13 mm
 - 4 x 7.5 x 19 mm
 - 4 x 5 x 13 mm
 - 5 x 7.5 x 19 mm
 - 3 x 6.5 x 16 mm
 - 5 x 9 x 22 mm
 - 4 x 6.5 x 16 mm
 - 6 x 9 x 22 mm



Item #
8117



Electrical Clip Assortment | 28 pcs.

- alligator clips and charging clips in assortment box
- surface finish: galvanised



Item #
8138



Molly Bolt Assortment | 40 pcs.

- metric
- sizes: 4 - 5 - 6 mm (each long + short)
- in plastic storage case
- surface finish: galvanised



Item #
8139



Plastic Plug Assortment | 58 pcs.

- for closing the following bore sizes:
 - 10 plugs Ø 10.0 mm
 - 10 plugs Ø 13.4 mm
 - 10 plugs Ø 13.5 mm
 - 8 plugs Ø 19.4 mm
 - 10 plugs Ø 19.5 mm
 - 10 plugs Ø 22.2 mm
- in assortment box



Item #
9406



Screw Securing Wire

- ideal for securing screws
- size: Ø 0.7 mm x length: 15 m
- for use with wire spinning pliers
- material: stainless steel



Item #
8478



Ramp Set | foldable | 2 pcs.

- multi-purpose and mobile
- for loading and unloading quads, motor bikes, lawn mowers etc.
- can also be used as car stand when folded
- suitable for trailers with 700 to 900 mm loading height
- maximum capacity per ramp: 1.100 kg (folded), 350 kg (unfolded)
- space saving because it folds
- dimensions 580 x 160 x 265 mm (folded)
- overall length 1985 mm (unfolded)
- carrying handle for easy transport
- length: 1985 mm



Item #
2999

Access Ramp | 1 pc

- extra strong and wide finish
- 840 mm deep
- height: 210 mm
- capacity: 2 tons when using 2 platforms
- for tyres up to 195 mm width
- to be used pairwise only

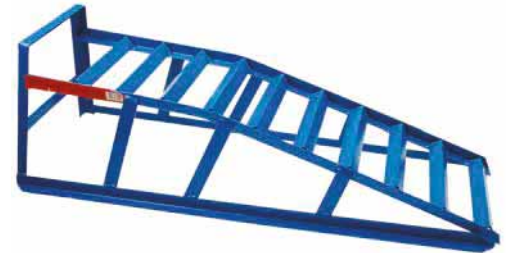

Item #
3001

Car Positioning Shells | 1 Pair | 680 kg

- heavy duty type
- capacity per piece: 680 kg (for safety reasons use pairwise only)
- ideal for manoeuvring in small areas
- each car positioning shell has 4 single lockable wheels
- ideal tyre grip on the car positioning shell because of checkered plate surface



Item #
9480



Car Positioning Shells | 1 Pair | 450 kg

- capacity per piece: 450 kg
- ideal for maneuvering in e.g. small areas
- with 4 steel castor wheels
- lateral struts prevent the tyre from slipping
- max. tyre width: 360 mm
- length: 605 mm
- width: 385 mm



Item #	Description
8386	Car Positioning Shells 1 Pair 450 kg
8386-1	Rollers for BGS 8386

Car Positioning Jack | hydraulic | 600 kg

- easier to maneuver in the smallest space
- ideal for exhibitions, workshops and towing companies

BGS 1975

- load capacity 600 kg per positioning jack
- tire width up to max. 290 mm
- ground clearance: 145 mm
- max. lifting roll distance: 650 mm (extended)
- min. lifting roll distance: 300 mm (retracted)
- dimensions: 630 x 550 mm

BGS 8604

- load capacity kg per positioning jack
- tire width up to max. 330 mm
- ground clearance: 160 mm
- max. lifting roll distance: 610 mm (extended)
- min. lifting roll distance: 355 mm (retracted)
- dimensions: 650 x 620 mm



Item #	Description
1975	Floor Jack 600 kg
1979	Replacement Wheel for BGS 1975, 8604
1975-1	Hydraulic Cylinder for BGS 1975
8604	Floor Jack 600 kg
8604-1	Hydraulic Cylinder for BGS 8604

Truck Tyre Cart

- facilitates the transport of truck wheels
- lifting frame width: 500 mm
- lifting frame depth: 350 mm
- max. wheel weight: 68 kg
- width: 500 mm



Item #
9236

Axle stands | 1 pair

- heavy duty, 4 leg finish
- 10-step ratchet-type action
- with rubber pad



Item #	Description
3014	Axle Stands load capacity 2000 kg / pair stroke 278 - 423 mm 1 pair
3014-9	Rubber Protector for Axle Stands BGS 3014
3015	Axle Stands load capacity 3000 kg / pair stroke 285 - 420 mm 1 pair
3015-9	Rubber Protector for Axle Stands BGS 3015
3016	Axle Stands load capacity 6000 kg / pair stroke 420 - 600 mm 1 pair
3016-9	Rubber Protector for Axle Stands BGS 3016

Hydraulic Jacks

- BGS 1870, 1871 und 1974,
spindle length 60 mm (adjustable)
- BGS 1872,
spindle length 70 mm (adjustable)
- BGS 1973,
spindle length 80 mm (adjustable)



Item #	Description
1871	Hydraulic Jack 3 t
1872	Hydraulic Jack 5 t
1974	Hydraulic Jack 20 t

Hydraulic Jack | 10 t

- spindle length: 80 mm
- max. height: 520 mm
- min. height: 210 mm
- lifting height: 245 mm
- rated load capacity: for up to 10 t

Item #
1977



Air Hydraulic Jack | 20 t

- or compressed air use, can also be operated by hand pump
- max. capacity: 20,000 kg
- size of foot: 223 x 133 mm
- min. height: 260 mm
- max. height: 510 mm
- adjustable height: 80 mm
- stroke: 170 mm
- working pressure 8 to 9 bar
- weight: 16.3 kg

Item #
2883



Jack | pneumatic | mobile | 22 t

- piston stroke: 120 mm
- 4 attachments for different min. and max. heights:
 - Ø 48 mm, length 20, 60 and 100 mm
 - Ø 68 mm, length 25 mm
- 80 mm lifting spindle, adjustable
- air inlet: 6.3 mm (1/4") NPT
- wheel diameter: 72 mm
- air hose: 10 mm outer diameter, length 1.2 m
- working pressure: 6.9 – 8.3 bar (120 – 200 PSI)
- max. lifting height 435 mm
- working pressure: 6.9 - 8.3 bar
- rated load capacity: 22 t
- free height 260 mm

Item #
2888



Floor Jack | hydraulic | Aluminium | 1.5 t

- low weight aluminium construction
- min. height: 125 mm
- max. height: 340 mm
- length 492 mm
- width: 230 mm
- weight 9.2 kg
- front castors: Ø 65 mm
- steering castors: Ø 40 mm
- with convenient carrying handle

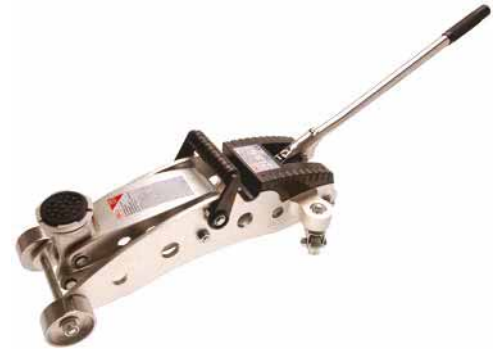

Item #
2885



Floor Jack | hydraulic | Aluminium-Steel Construction | 1.5 t

- dual piston hydraulic
- durable and lightweight aluminum-steel construction
- lever tube partly with protector prevents damage to the vehicle
- low headroom, thus particularly suitable for vehicles with low ground clearance
- length: 554 mm
- max. lifting height 358 mm
- min. lifting height 90 mm
- weight: 15.5 kg
- rated load capacity: 1.5 t



Item #
2897



Floor Jack | hydraulic | Aluminium-Steel Construction | 2.5 t

- dual lifting piston
- durable and lightweight aluminum-steel construction
- min. height: 155 mm
- front castors: Ø 65 mm
- steering castors: Ø 45 mm
- length: 640 mm
- width: 285 mm
- max. height: 460 mm
- min. height: 100 mm
- power supply: 26.6 kg
- rated load capacity: for up to 2.5 t



Item #	Description
2889	Floor Jack hydraulic Aluminium-Steel Construction 2.5 t
2889-1	Spare Hydraulic Unit for BGS 2889
2889-2	Replacement Rubber Pad for BGS 2889

Floor Jack | hydraulic | extra flat | 2 t

- extremely low headroom, also suitable for vehicles with low ground clearance
- lifting side has double castors with tilt mechanism for better manoeuvring through grids, etc.
- castors made of PU for low running noise
- foam coated lever prevents damage to the car
- jacketed handle ring for more convenient operation
- additional foot pedal for quick lifting
- max. lifting capacity: 2000 kg
- min. height: 70 mm
- max. height: 500 mm
- weight: 40 kg
- length: 822 mm
- width: 360 mm
- height: 214 mm
- max. lifting height 500 mm
- min. lifting height 70 mm
- weight 40 kg
- rated load capacity: for up to 2 t



Item #
9252



Floor Jack | hydraulic | 3 t

- rugged steel construction
- 2 casters & 2 swivel casters, made of steel
- min. height: 130 mm
- max. height: 465 mm
- weight 27.7 kg
- length: 540 mm
- width: 330 mm
- height: 240 mm
- rated load capacity: 3 t



Item #
9255



Floor Jack | hydraulic | 3 t

- for lifting and manoeuvring of vehicles
- 4 metal castors, 2 swivel castors
- max. load: 3,000 kg
- lifting height: 140 - 520 mm
- weight 36.5 kg
- dimensions: (L x W x H) 660 x 344 x 180 mm (height without lifting tube)



Item #
9248



ATV/Quad Car Jack | 2500 kg

- especially for off-road vehicles with a high ground clearance
- allows easy lifting, even when lifting on soft underground
- has a setback locking mechanism for actuating tube
- lifting capacity (max): 400 kg
- max. lifting height: 930 mm
- min. lifting height: 130 mm
- weight: 14.5 kg
- rated load capacity: 2500 kg



Item #
2884

Hydraulic Workshop Press | 20 t

- facilitates renewal of e.g. wheel bearings, gear shaft bearings, rubber bushings etc.
- large work area with 9-way adjustable supporting surface
- big pressure gauge working: 0 - 1000 bar (0 - 14,500 psi)
- range: 20-1030 mm
- width: 530 mm
- stroke: 150 mm
- weight: 95 kg



Item #	Description
9246	Hydraulic Workshop Press 20 t
9246-1	Hydraulic Pump for BGS 9246
9246-2	Hydraulic Cylinder for BGS 9246
9246-3	Pressure Gauge for BGS 9246

Tow Bar | max. 2000 kg | 1.8 m

- suitable for cars with towing eye
- model with square head and shaft
- can be plugged together (3 parts)
- galvanized surface

Item #
3050



Tow Rope | max. 2000 kg | 1.5 - 4 m

- durable material
- suitable for cars with towing eye
- elastic and extendable length: 1.5 – 4 m
- colour: white-blue
- with heavy duty springloaded safety lock hook at each end of the rope

Item #
9660



Trailer / Towing Vehicle Tester | 7- / 13-Pin

- the tester allows a quick check of 12V electrical systems on trailers, cars, motorhomes, etc.
- suitable for 7- and 13-pin connectors
- incl. adaptor 7- to 13-pin and 13- to 7-pin
- for 9 V monoblock battery (not included)

Item #
2171



Trailer Plug and Car Socket Tester | 13-Pins

- the tester allows a quick check of electrical systems on trailers and cars, motorhomes, etc.
- allows to check trailer electrical system without a passenger car
- suitable for 13-pin 12 volt connectors
- for 9 V monoblock battery (not included)

Item #
2175



Tester for Trailers and towing Vehicle Electrics | 7- Pin

- the tester allows a quick check of 12V electrical systems on trailers, cars, camper vans, etc.
- suitable for 7-pin connectors
- for 9 V monoblock battery (not included)



Item #
2187

Chain Hoists

- closed body
- minimal amount of manual work needed due to special power transmission even when max. load capacity is reached
- for lifting, moving, positioning and securing loads
- with long operating chain and load hook



Item #	Description
3484	Chain Hoist lifting height 2.5 m 2 t
3483	Chain Hoist lifting height 2.5 m 1 t

Wire Rope Winch | 270 kg

- for mounting on transport trailer, boat trailer, etc.
- rope Ø: 4.2 mm
- length of rope: 8 m
- rope winding roller: Ø 48 mm
- crank length: 155 mm
- crank handle width: 89 mm
- max. load: 270 kg (275 daN)
- gear ratio: 3.1:1
- overall height: 118 mm
- note: suitable for pulling loads only, not for lifting!



Item #
3485

Power Puller

- for holding or pulling heavy loads, tensioning fences or for stationary vehicles
- rubberized handle provides good grip and trouble-free operation of the ratchet
- stable galvanized construction
- with ratchet function
- not to be used for lifting!



Item #	Description
3480	Power Puller 500 daN
3482	Power Puller 1000 daN

Battery Booster Cables

- with insulated terminals
- in a practical storage bag



Item #	Description
9610	Battery Booster Cables 200 A / 16 mm ² 3 m
9611	Battery Booster Cables 400 A / 25 mm ² 3.5 m
9612	Battery Booster Cables 600 A / 35 mm ² 3.5 m

Battery Booster Device | 840 A / 12 V

- for jump start on 12V batteries for cars, SUVs and light trucks
- battery voltage: 12 V
- battery capacity: 22 Ah
- peak current: 2500 A
- starting current: 840 A (5 s)
- battery type: lead battery, closed with solid electrolyte (AGM)
- 12 V cigarette lighter socket: 20 A protected, power source for other 12-V devices or for charging the start booster
- 12-V completely insulated jump start terminals with 87 cm flexible 25 mm² copper cable
- protected against voltage peaks
- charge condition display: LED display, 25% to 100%
- battery condition check by LED display
- charger: voltage supply 230 V AC, voltage output 12 V DC / 1.5 A with smart charging circuit, can remain on continuously without damaging the rechargeable battery or the start booster
- short recharging (approx. 3 - 5 min.) via jump start cable allowed



Item #
9613



Battery Lifter

- easy lifting and carrying of all kinds of batteries
- max. rated load capacity: 35 kg
- width: 110 - 180 mm



Item #
3230

Overvoltage Protection | 12 V

- prevents from dangerous overvoltage when welding
- rubber coated clamps and cable
- cable length: 195 mm



Item #
9620

Anti-Slip Mat | 1220 x 610 mm

- rollable
- all purpose
- with amazing anti slip function - all things stay in their place
- rubber mat can be cut to the size you need
- tearproof, shockproof and easy to clean
- length: 1220 mm
- width: 610 mm



Item #
65701

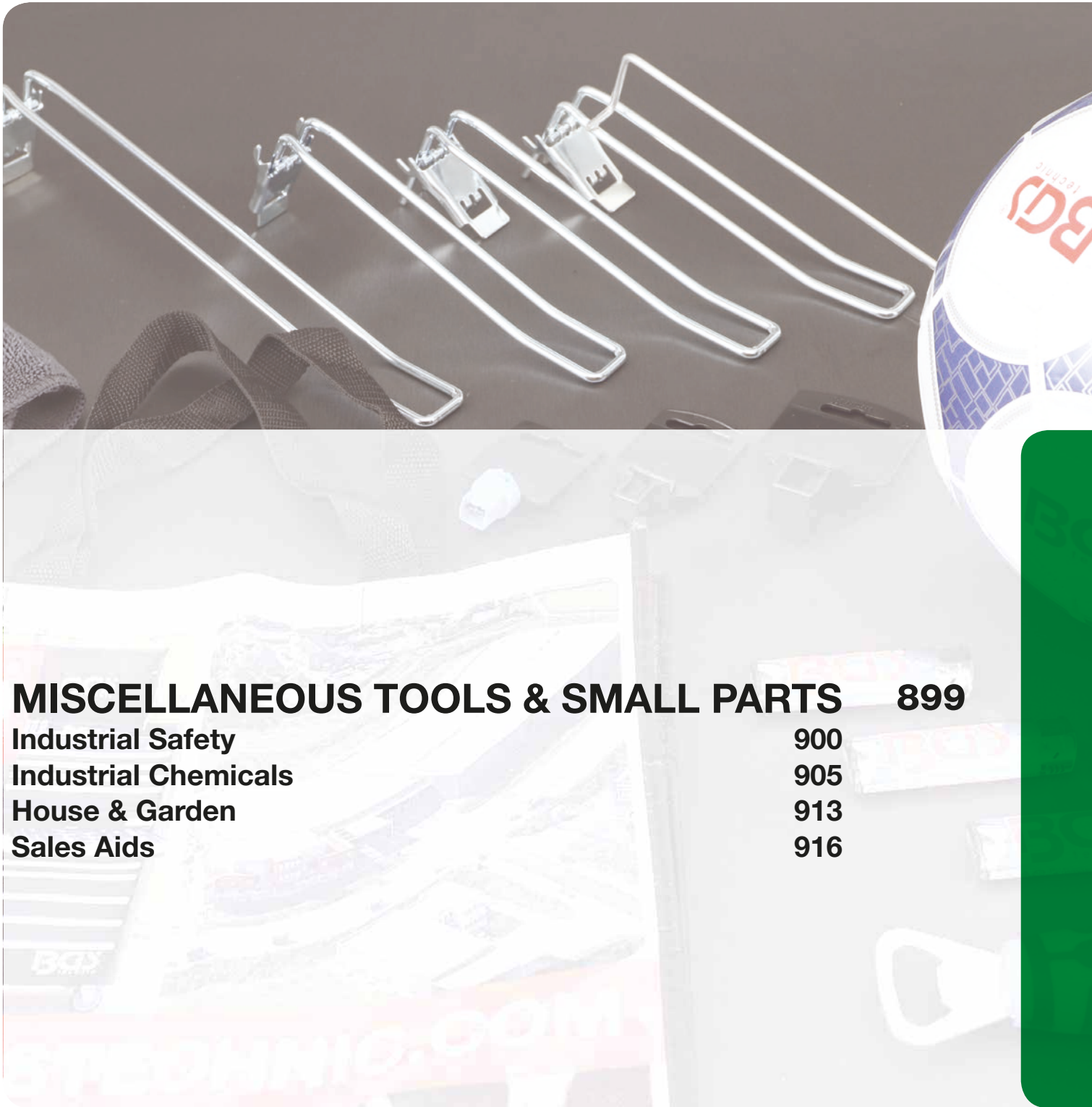

MISCELLANEOUS TOOLS & SMALL PARTS 899

Industrial Safety

900

Industrial Chemicals

905

House & Garden

913

Sales Aids

916

Visit www.bgstechnic.com for updates.

Subscribe to our Newsletter at www.bgstechnic.com and be the first to find out about new items in our product range.

Work Gloves

- non-slip coating
- high wearing comfort
- minimal impairment of the sense of touch, thus also suitable for fine-motor assembly work



Item #	Description
9949	Work Gloves Size 8 (M)
9950	Work Gloves Size 9 (L)
9951	Work Gloves Size 10 (XL)



Mechanic's Gloves

- PU part coating
- good fit and secure grip
- good sense of touch
- knitwrist
- for: tire services, Industries, motor vehicle sales and servicing, assembly and installation process



Item #	Description
9947	Mechanic's Gloves Size 8 (M)
9953	Mechanic's Gloves Size 9 (L)
9954	Mechanic's Gloves Size 10 (XL)
9956	Mechanic's Gloves Size 11 (XXL)



Work Gloves | Leather, lined | Size 10.5

- especially comfortable to wear as made of soft cowhide split leather
- material: cowhide split leather
- size: 10.5

Item #
9957



Welding Helmet | "SKULL" | auto darkening

- photoelectric liquid crystal light control
- field of view: 92 x 42 mm
- cassette size: 110 x 90 x 9 mm
- switching time 1/25,000 sec.
- time from dark to light 0.1 - 1.0 sec.
- deactivated status: DIN 4
- activated status: DIN 9 - 13
- external regulator for variable protection stages
- two internal regulators for variable sensitivity and delay
- automatic on / off
- power supply: battery CR2032
- UV / IR protection DIN 16
- arc sensor 2
- low-amp TIG => 5 Amp
- low battery indicator
- ADF self-test
- operating temperature: -5°C to + 55°C
- storage temperature: -20°C to + 70°C
- welding processes: MMA, MIG, MAG / C02, TIG, plasma welding and cutting
- weight: 480 g



Item #
8858



Welding Helmet | auto darkening

- carbon look
- photoelectric liquid crystal light control
- field of view: 98 x 40 mm
- cassette size: 116 x 95 x 18 mm
- plastic protection glass 110 x 90 mm
- switching time 1/25000 sec.
- automatic switching from dark to light
- deactivated status: DIN 4
- activated status: DIN 9 - 13
- external regulator for variable protection stages
- internal regulator for variable sensitivity
- automatic on / off
- power supply: solar
- operating temperature: -5°C to + 55°C
- storage temperature: -20°C to + 70°C
- welding processes: MMA, MIG, MAG / C02, TIG, plasma welding and cutting



Item #	Description
3516	Welding Helmet auto darkening
3516-1	Spare Disc for BGS 3516, 8858
3516-2	Replacement Headband for BGS 3516

Welding Helmet

- CE EN 175
- adjustable flexibly



Item #
3518



Welding Goggles

- foldable eye protector
- frame: clear glasses
- athermal glasses
- adjustable, elastic headband



Item #
3517



Safety Glasses | transparent

- with rubber band
- suitable for spectacle wearers
- with soft PVC frame
- with ventilation holes for fog-free view
- EN 166
- window colour: transparent



Item #
3622



Safety Glasses | transparent

- optimal coverage of the eye area
- fatigue-free through wavefront-optimized disc shape
- scratch proof
- optimal fit
- with earhooks
- ANSI Z 87 and CE EN 166 approved
- material: polycarbonate (pc)
- window colour: transparent



Item #
3627



Safety Glasses

- with UV protection
- sporty design
- optimal fit
- scratch proof
- EN 166 F approved



Item #	Description
3628	Safety Glasses grey tinted
3630	Safety Glasses not tinted (clear)

Safety Glasses with LED lighting | grey

- grey tinted
- with 2 LEDs for illuminating dark workpieces



Safety Helmet | with Visor and Ear Protection

- adjustable holding and neck straps
- for head size 52 to 62 cm
- folding face protection
- adjustable ear muffs
- complies with EN 397 / 352-3 / 1731

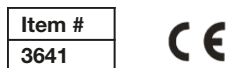

Safety Helmet | blue

- adjustable size 52 to 62 cm
- complies with EN 397
- PP shell



Industrial Safety Set | 3 pcs.

- ear defenders (EN 352)
- dust mask (EN 149)
- safety goggles (EN 166)
- EN 149 / 166 / 352



Item #
3625



Ear Defenders

- with adjustable and padded shells
- stepless quick adjustment
- noise reduction: 26 db
- EN 352-12002



Item #
3623



Dust Masks | 2 pcs.

- EN 149:2001



Item #
3620



Universal Cleaner | 5 l

- used in industrial applications, automotive sector, etc.
- suitable for spray pumps, high-pressure cleaners and to be used as a light alkaline ultrasonic cleaner
- ideal for ultrasonic cleaners BGS 8960 and 8990
- even at low doses, this cleaner increases the transfer rate and has excellent release and dirt soil carrying properties
- excellent wetting behaviour
- also suitable for manual cleaning
- mixing ratio: 1:1 up to 1:50
- pH value: 10 - 12



Item #
9380

Universal Industrial Cleaner | 5 l

- universal industrial cleaner with almost unlimited areas of use in manual, industrial cleaning
- highly concentrated, low foam all-purpose cleaner
- applications: garage, tools, plastic parts, glass, engines and many more
- mixing ratio: up to 1:50
- suitable for BGS 3277 twister gun



Item #
9381

GRP Repair Mat | 150 x 220 mm

- the GRP repair mat is a unique, easy-to-use repair film that is activated and hardened by UV radiation or sunlight: the film is made of glass fibre reinforced polyester with extremely good adhesion and a long life. no mixing, no weighing, no sources of error
- applications: maintenance and repair of roofs, stairs, basins, pipes, conduits, cable ducts, control boxes, bumpers, radiators, exhaust pipes, lines, box bodies, wind deflectors, all plastics and body parts, jet skis, boats, GRP fairings, model-making, windows, fences, roofs, doors and all surfaces made of wood, metal, glass, ceramics, masonry, concrete and plastic
- easy to use: simply cut to repair area, stick on - done
- extremely durable, glass fibre-reinforced plastic (GRP)
- vibration-resistant, remains flexible, weather, UV and damp-resistant
- good reworkability (sanding, drilling, painting, etc.)
- resistant to oils and solvents
- constant temperature resistance from -40°C to +200°C
- no shrinkage or expansion during processing and hardening
- adheres to all surfaces except polypropylene (PP)
- fast hardening (from 5 min. depending on UV radiation)



Item #
80601

Universal Sealant | Can 1.2 kg

- one-component, waterproof and paintable seal material for horizontal and vertical surfaces
- suitable for different areas, such as roofs, walls, wet cells, vehicles
- for vehicles as underbody protection and as a spreadable joint sealing
- waterproofing for roof lights, skylights, gutters, pipe junctions, wall connections, chimney connections, outdoor ventilation, cracks and fractures in masonry, etc.
- suitable for substrates such as Styrofoam®, plastics, concrete, wood, stone, metal, sanded roofing felts
- UV resistant and not sensitive to rain and spray water (even during curing)
- adheres to old and wet surfaces
- outstanding resistance to chemicals
- no subsequent stickiness on the surface
- excellent workability, only 2 coats are necessary
- colour: grey
- consistency: low-viscosity, pasty
- viscosity PP25, 11/s: 10 - 30 Pa.s
- hardens at room temperature
- spec. weight: 1.4 g/cm³
- skin formation 23 °C / 50% rel. humidity: 20 - 40 minutes
- hardening time: approx. 3 hours (1 mm layer thickness)
- processing temperature of: +5 °C to +40 °C
- temperature resistance of: -40 °C to +90 °C (when hardened)
- water vapour permeable
- consumption
- approx. 1.3 kg/m² at approx. 1mm application thickness
- approx. 2.1 kg/m² at approx. 2mm application thickness with fleece



Item #
80602

2-Component Special Glue | Cartridge 10 g

- best adhesion properties on many different materials such as leather, metal, wood, plastic, textil
- application in vehicle construction and industrial areas
- processing time: approx. 3 minutes
- temperature resistance: -20°C to +80°C, short-term up to +120°C
- thixotropic
- drip free
- extremely impact resistant
- mechanically editable
- filling capacity: up to 6 mm
- usable overhead and in vertical locations
- good chemical resistance
- low blowing
- transparent bonding of PMMA



Item #	Description
80603	2-Component Special Glue Cartridge 10 g
80603-1	Mix Grommets for 2K Special Adhesive Cartridge 10g 10 pcs.

2-Component Special Glue | FLEX | Cartridge 10 g

- 2-component cyanacrylate-based adhesive
- best adhesion properties on many different types of material such as metal, many plastics, e.g. PVC, ABS, PC, PBT, rubber, porose/absorbent materials such as wood, paper, cardboard, leather and textiles
- application: in vehicle construction and industrial areas
- thixotropic
- drip free
- extremely impact resistant
- mechanically editable
- usable overhead and in vertical locations
- good chemical resistance
- low blowing
- transparent bonding of PMMA
- incl. 3 mixing tubes, additional tubes BGS 80603-1 can be ordered separately
- mix ratio: 4:1
- processing time: approx. 5 - 6 minutes
- temperature resistance: -40°C to +80°C, short-term up to +120°C
- processing temperature: from -25°C
- filling capacity: up to 6 mm
- break elongation: 200%



Item #
80614

2-Component Special Glue | METAL | Cartridge 10 g

- 2-component cyanacrylate-based adhesive
- best adhesive properties on many different materials: metal, many plastics, steel, aluminium, stainless steel, rubber, porous/absorbent materials
- application: in vehicle construction and industrial areas
- thixotropic
- drip free
- extremely impact resistant
- mechanically editable
- usable overhead and in vertical locations
- good chemical resistance
- incl. 3 mixing tubes, additional tubes BGS 80603-1 can be ordered separately
- colour: grey
- mix ratio: 4:1
- processing time: approx. 35 minutes
- temperature resistance: -40 °C to +80 °C, short-term up to +120 °C
- processing temperature: from -25 °C
- filling capacity: up to 6 mm



Item #
80615

Superglue | Medium Viscosity | Dispensing Pen 12 g

- latest generation of cyanoacrylate adhesive
- for bonding a wide variety of material connections (metal, rubber, wood, cardboard, ceramics and most plastics) to themselves and to each other
- despite residual flexibility, a very high strength is achieved with most materials
- remains flexible with fast hand-tight
- no impairment of electronic components
- innovative dosing option:
 - no running
 - valve gate
 - no clogging of the grommets
 - easy application of the adhesive
 - precise dosing
- basis: Methoxyethyl cyanoacrylate
- colour: transparent, clear
- viscosity 25°C (Brookfield): approx. 120 - 250 mPa.s
- density: approx. 1.12 g / cm³
- gap filling capacity: - 0.1 mm
- temperature resistance: from -50 to + 80 °C
- hand-tight: approx. 10 - 120 seconds
- final strength: 24 hours



Item #
80606

Superglue | Medium Viscosity | Bottle with Stand 25 g

- latest generation cyanoacrylate adhesive
- for bonding a wide variety of material connections (metal, rubber, wood, cardboard, ceramics and most plastics) to themselves and to each other
- despite residual flexibility, a very high strength is achieved with most materials
- remains flexible with fast hand-tight
- no impairment of electronic components
- innovative dosing:
 - no running
 - valve gate
 - no clogging of the grommets
 - easy application of the adhesive
 - precise dosing
- basis: methoxyethyl cyanoacrylate
- colour: transparent, clear
- viscosity 25°C (Brookfield): approx. 120 - 250 mPa.s
- density: approx. 1.12 g / cm³
- gap filling capacity: - 0.1 mm
- temperature resistance: from -50 to + 80 °C
- hand-tight: approx. 10 - 120 seconds
- final strength: 24 hours



Item #
80607

Screw Doctor - The Perfect Screwing Help | Tube 20 g

- allows tools such as screwdrivers or cordless drills a better grip when loosening and tightening all types of screws
- increases the friction between the tool and screw up to 500%
- very economical, one drop is sufficient for one screw



Item #
78950



Screw Locking Fluid | Medium Strength | High Viscosity | 50 g Pump Dispenser

- for securing, sealing and gluing of screw connections
- replaces common locking methods such as splints, spring washers, etc. suitable for engine construction, racing, mechanical engineering, in workshops and garages, for industrial applications, etc. • colour: dark blue
- max. thread size: M36
- viscosity range at 20 °C: 2,000 - 7,500 mPa.s
- max. filling capacity: 0.25 mm
- hand-tight: 10 - 20 min
- functional hardness: 1 - 3 h
- temperature resistance: -55 - 150 °C
- density at 25 °C: 1.05 g/cm³
- breakaway torque: 17 - 22 Nm (DIN EN ISO 10964)
- shear strength: 9 - 13 N/mm² (DIN 54452)



Item #
80604

Screw Locking Fluid | High Strength | 50 g Pump Dispenser

- for securing, sealing and gluing of screw connections
- replaces common locking methods such as splints, spring washers, etc.
- can be used in engine construction, racing, mechanical engineering, in workshops and garages, for industrial applications, etc.
- colour: green
- max. thread size: M20
- viscosity range at 20 °C: 400 - 700 mPa.s
- max. filling capacity: 0.15 mm
- hand-tight: 10 - 20 min
- functional hardness: 1 - 3 h
- temperature resistance: -55 - 150 °C
- density at 25 °C 1.10 g/cm³
- breakaway torque: 28 - 35 Nm (DIN EN ISO 10964)
- shear strength: 15 - 20 N/mm² (DIN 54452)



Item #
80605

Screw Locking Fluid | High Strength | High Viscosity | 50 g Pump Dispenser

- for securing, sealing and gluing of screw connections
- replaces common locking methods such as splints, spring washers, etc.
- can be used in engine construction, racing, mechanical engineering, in workshops and garages, for industrial applications, etc.
- colour: red
- max. thread size: M36
- viscosity range at 20 °C: 8,000 - 15,000 mPa.s
- max. filling capacity: 0.30 mm
- hand-tight: 20 - 40 min
- functional hardness: 3 - 6 h
- temperature resistance: -55 - 230 °C
- density at 25 °C 1.10 g/cm³
- breakaway torque: 20 - 35 Nm (DIN EN ISO 10964)
- shear strength: 15 - 25 N/mm² (DIN 54452)
- DIN-DVGW-NG-5146AT7033, DIN EN 751-1 class H
- not suitable for use in the gas installation in accordance with DVGW-TRGI 2008



Item #
80616

Pipe Thread Sealing | Medium Strength | Highly Viscous | 50 g Pump Dispenser

- secures and seals screw threads against oil, gas, water, hydrocarbons and many chemicals
- suitable for use in engines and electrical industry, tractor construction, marine industry, machinery and gear construction, pump construction, sanitary engineering, etc.
- replaces hemp as well as PTFE sealing tape and solid gaskets
- additional protection against corrosion
- colour: blue
- max. thread size: M56
- viscosity range at 25 °C: 15000 - 25000 mPa.s
- max. filling capacity: 0.25 mm
- hand-tight: 5 - 45 min
- functional hardness: 1 - 4 h
- temperature resistance: -55 - 180 °C
- density at 25 °C 1.05 g/cm³
- breakaway torque: 8 - 12 Nm (DIN EN ISO 10964)
- shear strength: 4 - 6 N/mm² (DIN 54452)
- strength class: 1 (DIN 30661)



Item #
80612

Bearing and Bushing Locking Fluid | High Strength | High Viscosity | 50 g Pump Dispenser

- for attaching bearings, bushes, shafts, hubs
- anaerobic liquid plastic that hardens on contact with metals in the absence of oxygen
- rapid curing
- resistant to many media
- extremely high strength, even on slightly oiled parts
- difficult to dismantle
- colour: green
- max. thread size: M36
- viscosity range at 20 °C: 1,500 - 2,500 mPa.s
- max. filling capacity: 0.20 mm
- hand-tight in 2 to 5 min
- functionally tight in 1 to 3 h
- temperature resistant: -55 - 150 °C
- density: 1.10 g/cm³ (at 25°C)
- breakaway torque: 30 - 40 Nm (DIN EN ISO 10964)
- shear strength: 25 - 30 N/mm² (DIN 54452)



Item #
80613

Surface Sealing | Medium Strength | 50 g Pump Dispenser

- for sealing gear and engine housings, flange connections, bearing caps and differential housing covers
- good for automotive and motorcycle industry, chemical and petrochemical industry, gas, water and electricity companies, drilling rigs and many more
- solvent-free design element for all seal sizes
- ideal for complicated shaped parts
- can be used on vertical surfaces thanks to thixotropic properties
- seals the parts against low pressures (about 5 bar) already after joining
- the max. pressure sealing capability of up to 350 bar is achieved with elimination of oxygen following complete hardening (depending on sealing surface size)
- colour: green
- viscosity range at 20 °C: 17,000 - 50,000 mPa.s
- max. filling capacity: 0.30 mm
- hand-tight: 20 - 40 min
- functional hardness: 1 - 3 h
- temperature resistance: -55 - 150 °C
- density at 25 °C: 1.10 g/cm³
- load: 2 - 4 Nm
- flashpoint: >100 °C
- shear strength: 4 - 6 N/mm² (DIN 54452)
- strength class: 1 (DIN 30661)



Item #
80608

Adhesive | Sealing and Assembly Agent | White | 120 g

- high-quality adhesive based on MS polymers
- for bonding metals, wood and plastics to and among each other in body and vehicle construction, container construction, sheet metal processing, apparatus engineering, air conditioning, yacht u. boat building
- elastic sealing of seams
- in areas where silicone cannot be processed. (silicone contamination when painting)
- permanently elastic adhesive
- high strength
- re-coatable with dispersion paints (alkyd paints may have a delayed drying time, test before)
- suitable for wet use
- resistant to UV, weather, (salt)water, moisture and chlorine, anti-fungal
- no edge zone contamination (very suitable for natural stones)
- very good adhesion on many substrates
- free of isocyanate, solvents, phthalate and silicone
- colour-tight
- odourless
- sandable (after hardening)
- very good adhesion to many substrates, in most cases without adhesive primer (for porous substrates, test in advance)
- ISEGA certificate no. 43705 U 16
- colour: white
- viscosity: pasty
- max. joint width: 25 mm
- density: 1.532 g/ml
- hardening in 24 hours: 3.0 mm
- shrinkage: none
- skin formation (23 °C / 55 % RF): approx. 10-15 minutes
- break elongation (DIN 53504): 300%
- e-type at 100% expansion (DIN 53505): 1.7 MPa
- hardness shore A (DIN 53505): 60
- temperature resistance: -40 °C to +100 °C, short-term up to +130 °C
- processing temperature 5 - 30 °C
- processing time: 10 min



Item #
80610

Display Carton "Liquid Tool"

- no content
- for counter presentation of:
 - e. g. 12 pump dosing 50 g or 12 bottles with base 25 g or combination of both

Item #
80609



Folding Spade | 625 mm

- 3-way adjustable
- length open: 625 mm
- length folded: 440 mm
- spade blade length: 215 mm
- spade blade width: 145 mm
- wooden handle length: 410 mm

Item #
2135



Tile Carrying Handle | 300 - 500 mm

- 6-step adjustable and fixable width: 300 - 350 - 400 - 450 - 480 - 500 mm
- window to show the width
- capacity: 50 kg
- with claws for firm grip
- surface finish: galvanised
- handle material: plastic

Item #
3231

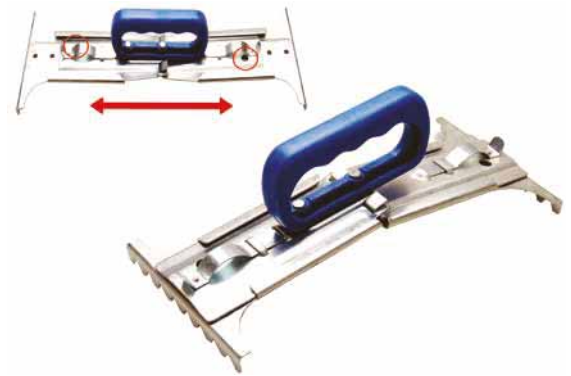

Chisel Set | 12 pcs.

- high quality steel
- different tip shapes for all applications
- length: each approx. 225 mm
- for easy and professional working
- handles made from high quality wood
- in wooden box

Item #
52712



Hole Punches Set | 3 - 12 mm | 9 pcs.

- in plastic case
- hole punches 3-4-5-6-7-8-10-11-12 mm

Item #
565



Hole Punches Set | 5 - 35 mm | 14 pcs.

- 13 interchangeable hole punches 5 - 6 - 8 - 10 - 11 - 13 - 16 - 19 - 22 - 25 - 28 - 32 - 35 mm
- 1 quick change punch holder with ergonomic handle design
- suitable for paper, plastic foil and rubber



Item #
566

Moisture Meter | 3-IN-1

- for measuring the moisture level in sawn timber, paper cardboard and hardened materials like mortar, concrete and plaster
- displays the moisture level immediately
- can also measure environment temperature

Measuring ranges:

- wood: 6 - 42 % (accuracy 0.1 %)
- building materials: 0.2 - 2.9 % (accuracy 0.1 %)
- temperature: 0 - 40°C, or 22 - 99°F (accuracy 1°C / 2°F)



Item #
2191



Staple Gun | for Staples 6 - 17 mm | Nails and Pins 12 - 16 mm

- weight 1300 g
- incl. 200 staples
- for staples 6 - 17 mm (type 50 and 53), nails and pins 12 - 16 mm
- surface finish: satin chrome plated



Item #
3010



Clamp, Bolt and Nail Assortment | 600 pcs.

- suitable for e. g. staple gun BGS 3010
- 200 staples, 17 mm long
- 200 bolts, 16 mm long
- 200 nails, 16 mm long



Item #
3010-1

Rubber Backing Disc | Ø 125 mm

- with 6 mm mandrel
- with hook and loop

Item #
3074

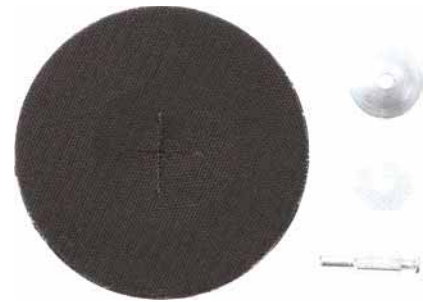

Pocket Gas Torch

- high flame temperature
- suitable for soldering, flambé, inflaming
- for use in workshop and kitchen
- equipped with piezo-ignition, lock switch and flame size regulator
- can be filled with conventional lighter gas

Item #
9872



Gas Soldering Torch Set

- for repairing switch boards, circuit boards, jewellery, loosening of rusted nuts, bolts and welding plastic
- dimensions: 220 x Ø 30 mm, gas container capacity: 26 ml
- operating time with one gas filling: 100 - 120 min.
- temperature: soldering tip up to 400°C, hot blow head up to 1300°C
- gas soldering iron, protective cap, solder, iron stand, heating needle, soldering tip, soldering tip (flattened on both sides), soldering tip (flattened on one side), heating block, deflection sheet

Item #
9942



Magnifier with Flexible Arm and Magnetic Foot

- focal length 320 mm
- magnifier diameter: 105 mm
- magnet diameter: 65 mm
- Ø 26 mm flexible arm
- magnification: 3x
- length: 260 mm

Item #
8372



BGS® Vintage T-Shirts



Item #	Description
16	BGS® Vintage T-Shirt Size XXL
18	BGS® Vintage T-Shirt Size 4XL
19	BGS® Vintage T-Shirt Size 5XL

BGS® Football



Item #
BALL

BGS® Bottle Opener



Item #
8



BGS® Banner/Flag | 2000 x 1000 mm

- made of special "flag" fabric
- all-round seamed
- length: 2000 mm
- width: 1000 mm

Item #
BANNER



BGS® Coffee Mug

Item #
BECHER



BGS® Shopping Cart Chip

Item #
Coin

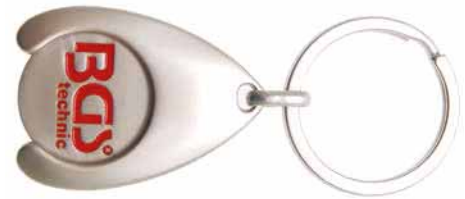

BGS® Lighter | 1 pc

- electronic lighter
- sales display included for each 50 pcs. ordered

Item #
F1



BGS® Ball Pen

Item #
Kugel



BGS® Bottle Opener

Item #
Öffner



BGS® poster | DIN A1



Item #
POSTER

Microfibre Cloth | 400 x 400 cm

- size: 400 x 400 mm
- 80% polyester-microfibre + 20% polyamide-microfibre
- weight approx. 300 g/m²
- embroidered with BGS logo
- perfect for cleaning tools after use



Item #
TUCH

BGS Shopping Bag

- sizes S (36 x 42 x 15 cm) and XL (46 x 44 x 25 cm) available
- XL version with long and short carrying handles
- strong and durable material, high load capacity



Item #	Description
9899	BGS Shopping Bag S
9898	BGS Shopping Bag XL

Sales Display for Tools | 1030 x 550 x 2240 mm

- Tegometal system
- extremely durable for multiple blinds
- suitable for shops
- includes two trays for the presentation of larger cases etc.
- length: 1030 mm
- width: 550 mm
- height: 2240 mm
- colour: silver

Item #	Description
49	Sales Display for Tools 1030 x 550 x 2240 mm
49-2	Additional Shelf for Sales Display BGS 49 1000 & 370 mm
49-3	Additional Shelf for Sales Display BGS 49 1000 & 470 mm
49-5	Sticker for Sales Display 49 400 & 180 mm
49-6	Back panel for Sales Display BGS 49 1000 & 200 mm
49-7	Acrylic Glass Insert for Illuminated Display 940 x 198 mm



Tool Exhibition Wall | 1000 x 450 x 2200 mm

- includes two trays for the presentation of larger cases etc.
- includes 50 hooks
- length: 1000 mm
- width: 450 mm
- height: 2200 mm

Item #	Description
57	Tool Exhibition Wall 1000 x 450 x 2200 mm
57-1	Additional Shelf for Sales Display BGS 57 970 & 355 mm
57-2	Hooks for Sales Display BGS 57 10 pcs.



Sales Display for Sockets/bits (empty)

- display for 315 sockets and bit sockets 12.5 mm (1/2")
- with EPE for top tray, prevents the bit sockets from falling out
- display dimensions (D x W x H) 335 x 410 x 270 mm



Item #
4095-2

BGS® Stickers

- especially suitable for sales trucks, shop windows, etc.



Item #	Description
AUFKLEBER	BGS® Sticker 500 x 300 mm
AUFKLEBER2	BGS® Sticker 250 x 150 mm

BGS® Beachflags

- BGS brand presentation flag for exhibitions, trade fairs and for in-house brand shops
- 110 g special printed flag material (100% polyester)
- aluminium plug-in bar, rotatable with fibreglass stick construction, incl. metal stand (approx. 4 kg; diameter Ø 80 cm)
- 5 l extra balance weight
- transportation bag
- delicate wash at 30°C, not suitable for tumble drying, resistant to ironing



Item #	Description
FLAG1	BGS® Beachflag Design 1 272 x 90 cm
FLAG2	BGS® Beachflag Design 2 272 x 90 cm
FLAG3	BGS® Beachflag Design 3 272 x 90 cm
FLAG4	BGS® Beachflag Design 1 422 x 90 cm
FLAG5	BGS® Beachflag Design 2 422 x 90 cm
FLAG6	BGS® Beachflag Design 3 422 x 90 cm

QUICKFINDER SINGLE SIZES



Sockets	QF1-5
Bit Sockets	QF6-8
Bits	QF9
Adaptors / Extensions / T-Bars / Flexible Handles	QF10
Spanners	QF11-13

HAND TOOLS

1

Workshop Trolleys	4
Socket Sets & Tool Assortments	73
Sockets	114
Bit Sockets & Bits	151
Ratchets, Extensions, Adaptors & Accessories	183
Torque Tools	202
Hand Tools	209
Pneumatic Tools	386
Electric / Cordless Battery Tools	426

AUTOMOTIVE TOOLS

435

Speciality Tools Motorbike	436
Speciality Tools SUV and Trucks	456
Speciality Tools Car	464
Workshop Equipment	464
Car Accessories	895

MISCELLANEOUS TOOLS & SMALL PARTS

899

Industrial Safety	900
Industrial Chemicals	905
House & Garden	913
Sales Aids	916

Alphabetical Index	923
--------------------	-----

Numerical Index	940
-----------------	-----

Description	Page
-------------	------

123

12-Point Socket Sets	133-135,137-138,140-141,150
2-Component Adhesives	906-908
3-pt Sockets	129

A

Abrasive Flap Discs	280
Accelerator Adjustment Tools	474,722
Accessory Set for Callipers	265
Adaptor for Brake bleeders	469-470
Adaptor for Extension Bars	201
Adaptor Sets	30,195-196
Adaptor with Torque Display	207
Adaptors	194-196
Adaptors for Double Ended Ratchet Wrenches	323
Adhesives	906-908,912
Adjustment Tools (Engine)	46,60-65,626-702
Air Adaptors for Cylinders	820
Air Adaptors for Glow Plug Holes	820
Air Airbrush Guns	410
Air Angle Drills	397
Air Assembly Tools for CV Boot	417
Air Belt Grinders	410
Air Blow Gun Cleaning Sets	413
Air Blow Guns	399-401,411-412,417
Air Blow Pens	399-401
Air Blow Pins	399-401
Air Body Jigsaws	397
Air Brake Bleeders	467-471
Air Brake Piston Wind Back Tools	476-478
Air Car Jacks	891
Air Caulking Guns	418
Air Chisel Kits	418-422
Air Chisel Sets	418,420-422
Air Cleaning Guns	401-402
Air Combi Nailers	420
Air Conditioning Test Equipment	814
Air Conditioning Tools	591
Air Conditioning V-ribbed Belt Tools	735
Air Cutters	408
Air Cutting Chisels	421-422
Air Cutting Discs	409-410
Air Dent Hammers	398
Air Dent Pullers	398
Air Die Grinders	406-407
Air Disk Cutters	408
Air Drift Sets	421
Air Drills	395-396
Air Eccentric Sanders	409-410
Air Edge Setter Pliers	397
Air Exhaust Air Hoses	423
Air Exhaust Pipe Chisels	421-422
Air Filter Wrench	804
Air Filters	422
Air Foam Guns	417
Air Fuel Extraction Units	419
Air Grease Guns	418
Air Hammer Impact Drivers	422
Air Hammer Sets	421
Air Hoses	403-406
Air Hydraulic Pumps	764
Air Impact Wrench	386-392
Air Inflating Pillow	579
Air Jig Saws	397
Air Lever Grease Guns	418
Air L-Keys	409-410
Air Micro Die Grinders	406-407
Air Multi-Function Tools	419

Description	Page
-------------	------

Air Multi-Tools	395
Air Nailer	420
Air Needle Scalers	418
Air Nibblers	397
Air Nipple	423
Air Oilers	422-423
Air Paint Sprayer	411-412
Air Plug Nipples	424-425
Air Polishers	409-410
Air Pressure Cleaners	417
Air Punch Pliers	397
Air Quick Couplers	423-425
Air Ratchet Wrenches	393-394
Air Riveters	417
Air Rotary Connectors	423
Air Sand Blasting Cabinets	413-414
Air Sandblaster Guns	414-415
Air Seal Cutters	415-416
Air Shears for Metal Sheets	397
Air Sheet Metal Nibbler	397
Air Spot Weld Cutters	398
Air Spray Bottles	416-417
Air Spray Guns	411-412
Air Thread Plug Nipples	424-425
Air Tool Holders	68
Air Tools	386-425
Air Tyre Inflation Guns	401-402
Air Tyre Inflators	401-402
Air Underbody Coating Guns	412
Air Window Seal Cutters	415-416
Airbag Release Tools	495
Airbag Tools	493
Airbrush Guns (Air)	410
Alligator Clip Assortment	887
Alternator Cover Pullers	447
Alternator Drive Flange Holders	451
Alternator Tool Sets	623-626
Aluminium Hacksaw Frames	271-272
Aluminium Miter Boxes	273
Aluminium Tool Cases	331
Aluminium Water Levels	266
Angled Drill Heads	228-229
Anti-Slip Mats	898
Assembly Cart Attachments	21
Assembly Fork Sets	513-514
Assembly Forks	519
Assembly Hooks	589-590
Assembly Hooks for Brake Springs	486
Assembly Hooks for Headlights	486
Assembly Hooks for O-Rings	864
Assembly Levers for Truck Tyres	457
Assembly Pliers	375-376
Assembly Tools for Callipers	485
Assortment Compartments	46,47
ATV Car Jacks	894
Auger Drill Bit Sets	225
Automatic Bit-Holders	172-174
Automatic Centre Punches	255
Automatic Wire Strippers	342
Automotive Clips	852-859
Axes	218
Axle Boot Clamp Sets	506
Axle Boot Clamps	66,357,362-363
Axle Boot Installing Tools (Air)	417
Axle Boot Pliers	504
Axle Boot Set	506
Axle Damper Socket	440
Axle Socket Tools	458
Axle Stands	890
Axle Tolerance Testing Tool	505

Description	Page
B	
Bags	918
Balance Shaft Pullers	718
Balancer Shaft Fixing Tools	719
Ball Bearing Separators	213-214
Ball Ejectors	516
Ball Joint Ejectors	513,517-519
Ball Joint Ejectors (Commercial Vehicle)	460
Ball Joint Pullers	516,521
Ball Joint Separators	513,516-519
Ball Joint Separators (for Commercial Vehicles)	460
Ball Joint Sockets	114
Ball Joint Spreaders	516
Ball Joint Tools	513-516,519-520
Ball Joints	200
Ball Pen	917
Ball Point Reversible Ratchets	188
Ball Point Tools	512
Banner/Flags	916
Bar Clamps	326
Basin Wrench	275-276,458
Batteries	268
Battery Disconnect Adaptors	811
Battery Emergency Switches	811
Battery Filler	810
Battery Lifter	898
Battery Load Testers	809-810
Beachflags	920
Bearing Drivers	552-553
Bearing Inner Ring Puller	216
Bearing Pullers	213
Bearing Ring Drivers	717
Bearing Ring Puller	218
Bearing Ring Removal Tools	547
Bearing Tight	911
Belt Gauges	732
Belt Pulley Holders	713
Belt Pulley Pullers	217-218,716
Belt Pulley Wrenches	731-732
Belt Tensioner Wrenches	656
Belt Tensioners	695
Bench Vice Clamping Tools for Struts	511
Bench Vice Handles	324
Bench Vice Jaw Protectors	325-326
Bench Vises	324
Bendy Lamps	770
Bimetal Hole Saws	219
Bit Adaptor	172-174
Bit and Socket Sets	176
Bit Holders	172-174
Bit Ratchet Adaptor	195
Bit Ratchets	182,189-190
Bit Screwdriver	197
Bit Sets	29,51,175-182
Bit Sets Spline (for XZN)	171
Bit Socket Sets	29,151-171
Bit Socket Sets (Inch Sizes)	155,158-159
Bit Socket Sets Cylinder Head Screws	154
Bit Socket Sets Internal Hexagon	152-159,166
Bit Socket Sets Special Automotive Sizes	152
Bit Socket Sets, Spline (for RIBE)	163-164
Bit Sockets	QF6-8,22,53
Bit Sockets Sales Displays	142
Bit Sockets specially for cars	152
Bit Spinner Handles	197
Bits	QF9, 171-172
Bits Internal Hexagon	171
Bits T-Star (for Torx)	171-172
Blades	261
Bleeder Bottle for Brakes	442

Description	Page
Bleeder Nipple	469-470
Bleeder Wrench for Brakes	473-474
Bleeding Tools for Cooling Systems	592-593
Blind Rivet Devices	355
Blind Rivets Assortments	859
Blindhole Bearing Puller	215
Blow Guns (Air)	399-401
Blow-dryer	428
Body Chisels	256-258
Body Dent Removal Tools	561
Body Edge Protection	575
Body File Holders	562
Body File Sheets	562
Body Pliers	347-352
Body Repair Clamps	558-560
Body Repair Kits	555,560
Body Sheet Shears	37-38,262
Bolt Cutter	371
Bonnet Lamps	771
Boosters	426,897
Bottle Opener	916,917
Bowden Cable Hose Clamp Pliers	66
Bowden Cable Oiler	444
Bowden Cable Pliers	357,359
Brake Band Piston Assembly Tools	526
Brake Bleeder Tool Adaptors	469-470
Brake Bleeder Tools	467-471
Brake Bleeder Valves	471
Brake Bleeder Wrenches	473-474
Brake Bleeding Bottles	442,471-472
Brake Cable Spring Pliers	490
Brake Calliper Bleeder Adaptor Sets	482
Brake Calliper Brushes	484-485
Brake Calliper Carrier Repair Kits	483-484
Brake Calliper Files	485
Brake Calliper L-Key	486
Brake Calliper Sealing Groove Cleaners	486
Brake Calliper Socket	456,483-484
Brake Cylinder Honing / Cleaning Tools	753
Brake Disc Calliper	487-488
Brake Drum Gauges	491
Brake Drum Tools	488-489
Brake Flaring Tools	464-466
Brake Fluid Tester	812
Brake Line Scrapers	473
Brake Line Wrenches	472-473
Brake Lining Wear Indicators	487-488
Brake Pedal Adjusting Tools	474
Brake Pedal Separating Tools	486
Brake Piston Pliers	442
Brake Piston Removal Sets	442
Brake Piston Reset Tools	481
Brake Piston Wind Back Adaptors	478-479
Brake Piston Wind Back Sets	50,456,475-481
Brake Piston Wind Back Spindles	479
Brake Saddle Assembly Bolts	485
Brake Spring Assembly Tools	489-490
Brake Spring Mounting Hooks	486
Brake Spring Pliers	490
Brake Thread Repair Kits	482
Branch Connector Sets	876
Brass Caliper Brushes	484-485
Brush Assortments	46
Brushes	229-234
Brushes for Tyre Mounting Lubricant	839
Bumping Hammers	251-252,254, 560-561,845
Bush Extractors	462
Bushing Drivers	552-553
Bushing Locking Fluids	911

Description	Page
-------------	------

Button Pliers	377
---------------	-----

C

Cable Cutters	372
Cable Drums	431
Cable Knives	263
Cable Lug Assortment	875
Cable Lug Crimping Tools	342
Cable Lug Pliers	346-347
Cable Splice Release Tools	493-494
Cable Tie Tensioning Guns	378
Cable Ties	874
Cable Winches	896-897
Cable Wire Strippers	343
Caliper	264
Caliper Accessories Sets	265
Calipers for Brake Disc	487-488
Calliper for Inch Screws	267
Calliper for Tyre Tread Measurement	836
Camber Adjusting Tools	527-528,530
Camshaft Central Valve Sockets	700
Camshaft Locking Tool (Motorcycle)	448-449
Camshaft Locking Tools	702
Camshaft Pulley Extractors	657
Camshaft Pulley Nut Sockets	451-452
Camshaft Rulers	701
Camshaft Spacers	706
Camshaft Sprocket Locking Tools	689-690
Camshaft Sprocket Puller	218,451,657
Camshaft Tools	704-708
Can	767
Cantilever Tool Box	331
Cap Nut Assortment	881
Cap Wrench Set	458
Car Fuse Assortment	883-884
Car Light Tester	831
Car Multimeter	825-829
Car Opening Sets	578-579
Car Positioning Shells	888
Car Tyre Boosters	837
Car Windshield Removal Tool	567
Carabiner Hook Assortment	886
Carbon Dioxide Leak Testers	815
Carburetor Screwdrivers	294,621
Carburetor Testers	453
Carrier Bags	918
Carrier Handles for Tiles	913
Castor Adjustment Tools	530
Castors for Workshop Trolley	72
Catalytic Converter Pressure Cleaner	417
Caulking Guns	764-765
Center Punches	50,254-255
Central Lifts for Enduros / Cross Motorcycles	455
Centre Bit Sets	225
Centring Tools for Clutch Disc	452
Chain Adjusting Tools	438
Chain Cutters (for Motorcycle)	438
Chain Housing Cover Alignment Tools	655
Chain Oil Filter Wrench	41,793-794
Chain Pipe Cutter	595
Chain Pulleys	896
Chain Saw Sharpeners	281
Charging Clip Assortments	887
Charging System Testers	810
Chisel Sets	43,50,913
Chisels	254,256-258
Cigarette Lighter Removal Tool for VAG	496
Circlip Assortment	885-886

Description	Page
-------------	------

Circlip Pliers	372-375
Circlip Pliers Sets	36,58
Circlip Squeezing Pliers	376
Circlip Tool Sets	376
Clamp Pliers	40,365-366,504
Clamp Pliers for Drive Shafts	379
Clamp Pliers for Special Exhaust	598
Clamping Jaw Flaring Tools	464-466
Clamping Jaws for Flaring Tools	464-466
Clamping Pliers	342,353
Clamping Screw Removers	532
Clamping Tool for Hose Clamps	363-364
Clamping Tool for Threading Die	250
Clamping Wrench for Adjusting Track Rods	529-530
Claw Socket for Mercedes Ignition Lock Rosette	131,580
Claw Tools	772
Claws	772,774
Cleaning Agents	905
Cleaning Brushes for Glow Plug Shafts	609
Cleaning Brushes for Injector Seats	609
Cleaning Brushes for Motorcycle Chains	439
Cleaning Brushes for Stud Bolts	234
Cleaning Brushes for Wheel Nut Bolts	234
Cleaning Kits for Paint Spray Guns	413
Cleaning Nozzle Adjusting Tools	584
CLIC Hose Clamp Pliers	361-362
Clip Assortments	852-859
Clip Removers	586
Clip Rivet Pliers	578
Clutch Cage Counteracting Spanners	446
Clutch Cage Holders	438
Clutch Cage Holding Tools	446,448
Clutch Disc Centring Tools	452
Clutch Tools	453,522-525
CNG Cylinder Valve Wrenches	623
Coating Thickness Gauges	815
Coating Thickness Gun	815
COB LED Lamps	770-771
Coffee Cups	917
Coils for Induction Heaters	433-434
Color Bit Sets	180,182
Combi Bit Sets	29,51
Combination Air Nailer	420
Combination Edge Setter and Folding Pliers	557
Combination Pliers	379-381
Combination Spanner Holders	323
Combination Spanner Sets	112,297-305
Combination Spanners	QF11,31,54-56,323
Combination Wrenches	320
Commercial Vehicle Tools	456-463
Common Rail Diagnosis Kit	612-613
Common-Rail High Pressure Pump Sprocket Pullers	23
Compressed Air Adaptor	820
Compression Tester	817-819
Compressor Pressure Regulator	422
Connector Disassembly Tools	495
Connectors	343
Contour Gauges	561
Control Cabinet Key	275-276
Cooler Filling Device	594
Cooling Hose Removers	368
Cooling System Bleeding Tools	592-593
Cooling System Chargers	592-593
Cooling System Diagnostics Tool Sets	460
Cooling System Filling Tools	592-593
Cooling System Pullers	591-593
Cooling Water Cans	757-758
Copper Drain Plug Seal Rings	792
Copper Hammers	252

Description	Page
Copper Ring Assortment	866-869
Cordless Angle Grinder	430
Cordless Bendy Lamps	770
Cordless Caulking Guns	427
Cordless Drills	429
Cordless Grinders	429-430
Cordless Polishers	429-430
Cordless Polishing Machines	429-430
Cordless Tools	432
Cotton Polishing Heads	278
Cotter Pin Assortment	870-871
Counteracting Spanners for Fly Wheels / Clutch Cage	446
Countersink Sets	226
Countersinks	329
Crankshaft Belt Pulley Holding Tools	717-718,721
Crankshaft Locking Tools	462,689-690,696
Crankshaft Locking Tools (Bike)	448-449
Crankshaft Pullers	714
Crankshaft Sealing Washer Tools	719
Crankshaft Tools	703
Creeper Roller	847-850
Crimping Pliers	38,39,346-347,377
Crimping Tools	38,39,344-347
Cross Chisel	256-258
Cross Screwdriver Sets	48,49,54,57
Cross Slot (Car)	533
Cross Slot (Sanitary)	274
Cross Slot (Truck)	457-458
Cross Slot Bit Socket Sets	154
Cross Slot Screwdrivers	282-285,288-290,294
Crowbar	777
Crowfoot Spanner Sets	295-296
Crowfoot Spanners	42
Crowfoot Wrench Sets	295-296
Crowfoot Wrenches	42
Cup Brushes	232-234
Cup Holders	68
Current Tester	825-829
Current Tester for Fuses	830
Cutter	236-237
Cutting Chisel Sets for Ball Bearings	213-214
Cutting Chisels	256-258
Cutting Discs	282
Cutting Knives Set for Air Window Remover	416
Cutting Wire Counterholder	567
Cutting Wire for Windscreens	565-566
Cylinder Head Repair Tools	722
Cylinder Head Screws Bit Socket Sets	154
Cylinder Head Sockets	131
Cylinder Head Stud Tools	722
Cylinder Liner Pullers	462
Cylinder Valve Wrenches	623

D

Dashboard Protector	568-569
Deburring Tool	270
Dent Mirror	576
Dent Removal Pens	575
Diagnostic Tool Set for Cooling Systems	460
Diagnostics Case for Turbochargers	723-724
Diagonal Side Cutters	369-370
Diamond Core Drill Bits	219
Diamond Files	235-236
Diamond Grinding Tools	237
Diesel Filter Sockets	619
Diesel Injection Nozzles Test Equipment	613-614
Diesel Injector Tools	599-615
Diesel Low Pressure Circuit Bleeding	621
Diesel Pump Adjustment Tools	689-690

Description	Page
Diesel Pump Sprocket Pullers	657
Diesel Service Filling Pumps	756
Digital Dial Gauge	268
Digital Laser Thermometer	832-833
Digital Micrometer	265
Digital Multimeter	825-829
Digital Protractors	266
Digital Refractometer	594
Digital Tachometers	499
Diode Testing Light	830
Disassembly Levers for Truck Tyres	457
Disc Brushes	232-234
Disc Puller for Camshaft	713
Document Storage for Workshop Trolleys	70
Document Trays for Workshop Trolleys	19-20,70
Document Trays for Workshop Trolleys PRO	70
Door Adjusting Lever	577
Door Adjusting Tool	577
Door Bolt Mounting Tools	578
Door Handle Tools	579
Door Hinge Mounting Tools	577
Door Opener Sets	578-579
Door Trim Removal Tools	587-588
Double Clutch Tools	524,526
Double Open End Ratchet and Flexible Spanners	316
Double Open End Spanner	QF13
Double Open End Spanner Sets	31,305-306,321
Double Ring Spanner	QF12-13
Double Ring Spanner (open)	312-314
Double Ring Spanner Sets	31,307-314
Double Ring Spanner Sets for Tool Box	112
Double Rubber Suction	569-571
Double T-Handle	198
Double-Joint Pliers	382
Double-Joint Side Cutter	370
Drawer Dividers for Workshop Trolley	71
Drill Adaptor Sets	172-174
Drill Chuck	228
Drill Chuck Key	229
Drill Grinding Attachment for Twist Drills	227
Drill Sets	219-227
Drill Sockets	227-228
Drive Belt Gauges	736
Drive Shaft Bit Socket Set	162
Drive Shaft Feeder Set	501
Drive Shaft Puller	501
Drive Shaft Removal Tools	505
Drive Shaft Socket Sets	145-146,505
Drive Shaft Threads	242
Drive Shaft Threads Repair Sets	504
Drive-On Ramps	888
Driver Tool Sets (motorcycle)	443
Drum Pumps	807-808
Dual-Mass Flywheel Testing Tool	525
Dust Masks	904

E

Ear Defenders	904
Ear Hose Clamp Pliers	363
Edge Protection for Body	575
Edge Protection Remover	587
Edge Protection Sets	839
Edge Setter Pliers	557-558
Edge Setter Pliers (Air)	397
Ejection Pliers	500
Elbow Connector Sockets	127-128
Electric Drill Adaptor Sets	194-195
Electrician's Scissors	263
Electronic Brake Resetting Devices	499

Description	Page
Electronic Combination Pliers	379
Electronic Diagonal Side Cutter	369
Electronic Long Nose Pliers	380
Electronic Mini Pliers	379
Electronic Round Nose Pliers	380
Electronic Soldering Stations	428
Electronic Stethoscope	831-832
Emergency Pumps	754-755
Emergency Switch for Batteries	811
Empty Cassettes for Small Parts	332
Empty Inlays	46,47
Empty Inlays for Tool Boxes	111-113
Empty Inlays for Workshop Trolleys	22-65
Empty Tool Case	331
End Cutting Pliers	370,382-383
Engine Compression Testers	817-819
Engine Cranes	760
Engine Mounting Ring Spanners	723
Engine Oil Dipsticks	806-807
Engine Stands	758
Engine Stethoscopes	831-832
Engine Supports	761-762
Engine Timing Tool for Alfa Romeo	63,642-644,685
Engine Timing Tool for Audi	62,65,684,687,691-711
Engine Timing Tool for BMW	46,626-640
Engine Timing Tool for Chevrolet	64,669,686
Engine Timing Tool for Chrysler	640-641,680
Engine Timing Tool for Citroen	61,641,649,659,671-676,683,714
Engine Timing Tool for Dodge	640
Engine Timing Tool for Fiat	61,63,64,642-651,675,683,685,686,714
Engine Timing Tool for Ford	61-65,651-657,659,675,681,683-687
Engine Timing Tool for Hyundai	687
Engine Timing Tool for Jaguar	658-660
Engine Timing Tool for Jeep	640
Engine Timing Tool for Lancia	63,64,642-653,685-686
Engine Timing Tool for Land Rover	632,658-660
Engine Timing Tool for Mazda	62,65,684,687
Engine Timing Tool for Mercedes-Benz	661-664
Engine Timing Tool for MINI	626-627,641
Engine Timing Tool for Mitsubishi	680,687-688
Engine Timing Tool for Nissan	60,678,682
Engine Timing Tool for Opel	60,63,64,648,650-671,678,680,682,685-686
Engine Timing Tool for Peugeot	61,641,649,659,671-676,683,714
Engine Timing Tool for Porsche	676-677
Engine Timing Tool for PSA	627,671-676
Engine Timing Tool for Renault	60,678-682
Engine Timing Tool for Saab	64,669-670,686
Engine Timing Tool for Seat	62,65,684,687,691-711
Engine Timing Tool for Skoda	62,65,684,687,691-711
Engine Timing Tool for Suzuki	63,64,648,685-686
Engine Timing Tool for Toyota	688
Engine Timing Tool for VAG	62,65,684,687,691-711
Engine Timing Tool for Volkswagen	62,65,684,687,691-711
Engine Timing Tool for Volvo	60,62,65,675,680-682,684,687,712
Engine Timing Tool Sets	46,60-65,626-702
English	320
Equaliser Flange Pullers	714
E-Ring Circlips Assortment	886
E-Ring Tool Sets	376
E-type Ratchet Ring Spanners	316-317
E-type Socket Sets	130-131,136,142,146-147,150

Description	Page
E-type Sockets	QF4-5
E-type Spanner Sets	311-312
E-type Spanners	54
Exhaust Air Hose for Air Tools	423
Exhaust Gas Recirculation Valve Disassembly Tools	598
Exhaust Gas Temperature Sensor Wrenches	597
Exhaust Pipe Chisels (Air)	421-422
Exhaust Pipe Compressor	598
Exhaust Pipe Expander Tools	594
Exhaust Pipe Remover	598
Exhaust Pipe Rubber Ejection Pliers	599
Exhaust Rubber Hook Set	598
Extendable Reversible Ratchet	187
Extension Bar Sets	QF10,30,191-194
Extension Bar Sets with Magnetic Holder	194
Extension Bars	190-194
External Pullers	209-218
Extraction Tool for Brake Shoe Springs	489
Extractor for Common Rail Injector Needles	609
Extractor for Screw and Studs	326-328
Extractor Sets	118-122
Eyelet Assortment	377,886
Eyelet Pliers	377

F

Face Plate Removing Tools	701
Feather Key Assortment	872
Feeder for Drive Shafts	501
Feeler Gauges	728
Fender Flaring Tools	556
Fender Protectors	851
Ferrules Assortments	876
Figure Punch Set	235
File Sets	39
Files	235-236
Files for Brake Calliper	485
Filling Flasks	757-758
Filling Nipple	423
Filling Tube for Liquids	757-758
Filling Tubes for Urea	756
Fine Contoure Gauges	561
Fine Thread Puller	209-210
Fir Tree Clip Assortment	858
Fitting Clamp Locking Pliers	351
Fixing Bolts for VAG Subframe	531-532
Fixing Clamps	353
Fixing Plates for Smart Repair	576
Fixing Tools for Camshaft	702
Flags	916
Flare Nut Spanners	41,42,312-314,317-318,472-473
Flaring Tools	464-466
Flashlight	768
Flat Chisel	256-258
Flat Nose Pliers	381
Flexible Belt Mounting Tools	735
Flexible Extension Bars	190,193
Flexible Grippers	772
Flexible Handles with Reversible Ratchet	200
Flexible Hexagon Screwdrivers	131
Floor Jack	889
Fluid Extractors	754-755
Fluid Flasks	757-758
Fluid Tanks	757-758
Flywheel Blocking Tools	626
Flywheel Holding Lever	715
Flywheel Locking Tools	450
Flywheel Pullers	446-447

Description	Page
Foam Inserts	22-66
Foam Inserts for Tool Boxes	111-113
Foil Erasers	281
Folding Benches	556
Folding Knife	45,263
Folding Pliers	557-558
Folding Rulers	267
Folding Spate	913
Foot Pumps	763
Footballs	916
Fork Cap Wrench for Öhlins Forks	440
Fork Ring Spanner Sets	297-305
Fork Ring Spanners	QF11,31,54-56
Fork Seal Drivers	444
Fork Separator Sets	513-514
Fork Type Separators	519
Forming Gas Leak Detector	813
Foru Way Wheel Wrenches	457-458
Free Wheel Ratchets	186
Front Axle Wishbone Bushing Tools	548
Front Hub Pullers	503
Front Wheel Bearing Pullers	547
Front Wiper Repair Kits	581
FSI Nozzle Assembly Tools	608
Fuel Filter Wrenches	619-620
Fuel Line Pliers	358,614-615
Fuel Line Sealing Plugs	368
Fuel Line Wrenches	616
Fuel Pressure Gauge	816
Fuel Pressure Testers	816
Fuel Pump Testers	817-819
Fuel Suction Devices	778,785,807
Fuel Suction Devices (Air)	419
Fully Equipped Workshop Trolleys	4-15
Funnel	756-757
Fuse Assortment	883-884
Fuse Tester	830

G

Gap Gauges	562
Gas Detectors	813
Gas Soldering Irons	915
Gas Torches	915
Gasket Scraper	278
Gaspipe Wrenches	356
Gauges	268
Gear Box Compression Test Kit	821
Gear Lock Ratchet Sets	76,86,92,104
Gear Lock Socket Sets	76,86,92,104,135,143,146
Gear Lock Sockets	QF3
Gear Oil Dipsticks	806-807
Gear Oil Filling Hoses	785
Gear Oil Filling Tools	783-785
Gear Wheel Puller for High Pressure Pumps	23
Gear Wheel Pullers	23
Gearbox Compression Testers	821
Gearbox Flange Pin Wrenches	458
Gearbox Lifter	759
Gearbox Setting Gauges	526
Gearbox Supports	762
Glaser Tools	564-567
Glasses	902-903
Gloves	900
Glow Plug Analysers	824
Glow Plug Electrodes Turn Off Sockets	746
Glow Plug Removal Tools	747
Glow Plug Shaft Cleaning Brushes	609
Glow Plug Socket Pliers	747

Description	Page
Glow Plug Socket Pullers	453,741
Glow Plug Sockets	744-746
Glow Plug Thread Repair Kits	748-752
Glow Plug Wrenches	744-746
Go-Trough Ratchet	188-189,273
Grease Nipple Assortment	880
Grinding Disc Flap	279-281
Grinding Mechanism Twist Drills	227
Grommet Assortments	870
Groove Nut Socket Sets	125-127
Groove Nut Sockets (Motorcycle)	441
Groove Nut Wrenches	125-127,459,461
Groove Nut Wrenches (Motorcycle)	451
GRP Repair Mats	905
Grub Screw Assortment	882

H

Hacksaw Frames	271-272
Hammer Sets	43,45,54
Hammer with Interchangeable Heads	254
Hammers	251-254
Hammers for Dent Pulling	560-561
Hand Axes	218
Hand Drills	330
Hand Grinder	561
Hand Pumps	754-755
Handheld Lamps	44
Handheld Lights	769-772
Handle	QF10
Handle Brushes	231
Handle for Bench Vices	324
Handle Hose Clamps Assortment	878
Handles for Glass Removal Wire	565
Hard Hats	903
HD Side Cutters	370
Head Lamps	768
Headlamps Adjustment Tools	496
Heavy Duty Gearbox Lifters	759
Helmets	903
Hexagon Nut Assortment	881
Hexagon Screwdrivers	364
Hexagon Socket Screwdriver	283,288
High End Taper Cutter	330
High Precision Drill Sets	226
High Pressure Pump Sprocket Locking Tools	711,721
High Pressure Pump Sprocket Puller	23,711,721
Holders for Camshaft Support	716
Holders for Clutch Cage	438
Holders for Toothbelt	717
Holding Rails for Clutch Baskets	446,448
Holding Tool for Drum Brake Pistons	491
Hole Cutter Sets	226
Hole Cutters	329-330
Hole Saws	219
Hollow Punch Sets	45
Hollow Punches	913-914
Honing Tools for Brake Cylinders	753
Hook Blades	261
Hook Sets	59,251,293
Hook Wrench	250,322
Hook Wrench with flexible Jaw	250
Hooks	589-590
Hooks for Exhaust Pipe Rubber	598
Hooks for O-rings	864
Hose Band Tensioning Tools	363-364
Hose Clamp Assortment	877-878
Hose Clamp Clamping Tools	66
Hose Clamp Pliers	40,357-362,365-366
Hose Clamp Pliers CLIC	361-362

Description	Page
Hose Clamp Pliers Set	66
Hose Clamp Pliers with Bowden Cable	357,359
Hose Clamp Screwdrivers	132,364
Hose Clamp Tools	357-362
Hose Clamps	366
Hose Connector Assortment	879
Hose Connector for Bleeding Diesel Systems	470
Hose Cutting Pliers	372
Hose Disconnecting Tools	616
Hose Flaring Tools	464-466
Hose Locking Pliers	367
Hose Pumps	755
Hose Scraper Pliers	368
Hoses for Tyre Inflation Guns	403
Hot Air Gun	428
HSS Counter Sinks	329
HSS Cutters	236-237
HSS Drill Sets	219-227
HSS Lathe Tools	281
HSS Saw Bows	271-272
HSS Screw Extractor Sets	120
HSS Taper Cutters	329-330
HSS Threading Dies	248
Hydraulic Adaptors	764
Hydraulic Drive Shaft Pullers	501
Hydraulic Flaring Tools	464-466
Hydraulic Floor Jack	892-893
Hydraulic Foot Pumps	763
Hydraulic Hoses	764
Hydraulic Jacks	890-893
Hydraulic Lifters for Motorcycle and ATV	454
Hydraulic Pullers	215,500
Hydraulic Pumps	764
Hydraulic Ram for Pullers	215
Hydraulic Shunt Lift Trucks	889
Hydraulic Workshop Presses	894

I	
Ignition Adjustment Gauges	452
Ignition Coil Extractors	741-742
Ignition Coil Pullers	719
Ignition Lock Rosette Sockets	131
Ignition Module Pullers	742
Ignition-Firing Testers	500
Impact Adaptors	196
Impact Ball Joint Sockets	114
Impact Ball Joints	196,200
Impact Bit Socket Sets	153-155,157-158,161-163,166-168
Impact Bits	22
Impact Chisel Sets	420
Impact Driver	294
Impact Driver, Offset Type	294
Impact Extension Bar Sets	194
Impact Extension Bars	192-194
Impact Extension Bars with Ball Bearing Handle	192
Impact Loosening for Oxygen Sensors	130
Impact Loosening Lever for Air Hammer	422
Impact Protection Sockets	114-116
Impact Socket Sets	80,103,143-150
Impact Sockets	QF4-5
Impact Wrenches	386-392
Impact Wrenches (cordless)	432
Inch Sizes Socket Sets	134-135,137-140,147,155,158-159
Inch Socket	QF1-2
Inch Socket Sets	74,77,79,81,94
Induction Coils	433-434

Description	Page
Induction Heaters	433-434
Induction Heating Unit	433-434
Industrial Cleaners	905
Injection Line Sockets	605-606
Injection Line Wrenches	604-606
Injection Nozzle Extractor	461,604-611
Injection Nozzle Seating Surfaces Cutter	604
Injection Pump Sockets	618,622
Injection Pump Wheel Pullers	722
Injector Copper Seal Ring Assortment	866,868
Injector Fastening Screws Repair Kits	23,243
Injector Gasket Pullers	609
Injector Puller Hooks	600-602
Injector Sealing Plugs	612
Injector Sealing Surfaces Cutters	603
Injector Seat Cleaning Brushes	609
Injector Seat Cleaning Tools	603
Injector Socket Set	602
Injector Tools	599-615
Inlays for Tool Boxes	111-113
Inlays for Workshop Trolleys	22-66
Inner Ring Pullers for Wheel Bearing	554
Inspection Mirror	775-776
Installation Wrenches for WC seat	274
Insulating Tape Rolls	873-874
Interior Lining and Clip Tools	585
Internal Hexagon Bit Socket Sets	152-159,166
Internal Hexagon Bit Sockets	QF6,QF8
Internal Hexagon Bits	QF9,171
Internal Hexagon L-Key Sets	332-336,339-340
Internal Hexagon Screwdrivers	283,288
Internal Hexagon Wrenches	58
Internal Pullers	209-218

J	
Jack	890-893
Joint Sets	30
Joint Socket Wrench Sets	56,135,138
Joint Socket Wrenches	316
Jump Leads	897

K	
Knee Protector Mats	850-851
Knife for Insulating Material	264
Knife Sets	45
Knives	259-260

L	
Lamps	767-772
Laser Thermometers	832-833
Lathe Tools	281
Laundry Basket for Small Parts	847
Lead Perlon Cable	590
Leak Detectors for Gas	813
Leak Testers for Gas, Air and Water Containers	816
Leather Gloves	900
LED Extension Bars	193
LED Flashlights	768
LED Head Lamps	768
LED Lamps	767-772
LED Magnet Lifters	774
LED Mirrors	776
LED Pens	767
Left Cutting Drill Sets	224
Letter Punch Set	235
Letters for Punching	235

Description	Page
Levels	266
Levels for Steering Wheel Settings	533
Lever Grease Gun Accessories	766
Lever Grease Guns	765-766
Levers	456
Lighters	917
Lights	767-772
Linchpin Assortment	871
L-Key (Air)	409-410
L-Key (cordless)	430
L-Key for Brake Calliper	486
L-Key Sets	332-339
L-Key Sets Internal Hexagon	332-336,339-340
L-key Sets Spline (for Ribe)	339
L-Key Sets TS-Star (for Torx Plus)	339
L-Key Sets T-Star (for Torx)	336-341
Lock Ring Pliers for Drive Shafts	379
Locking Clamp for Trunk Openers	580
Locking Handle for Bench Vices	324
Locking Pliers	367
Locking Pliers for Oil Filters	805
Locking Pliers Sets	37
Long Arm Hand Riveters	353-354
Long Nose Pliers	379
Longs Nose Locking Pliers	349-351
L-Type Key	340-341
L-Type Locking Pliers	351

M

Machinist's Hammer Sets	43
Machinist's Hammers	54,58,253
Magnetic Arm Rotation Angle Gauges	208
Magnetic Bench Vise Jaw Protectors	325-326
Magnetic Bit Holders	172
Magnetic Camber Gauges	530
Magnetic Compartments	47
Magnetic Cup Holders	68
Magnetic Holder for Bits and Socket Wrenches	173
Magnetic Holders	68,775
Magnetic Holding Rail Socket	69
Magnetic Holding Rails for Socket Wrenches	69
Magnetic Jaw Covers for Bench Vises	325-326
Magnetic Paper Towel Holder	68
Magnetic Pick Up Tools	44,772-775
Magnetic Shells	66-68
Magnetic Sockets for Oil Drain Screws	788-789
Magnetic Spray Can Trays	68
Magnetic Stand for Measuring Instruments	267
Magnetic Tray	66-68
Magnets	775
Magnifiers	915
Main Headlamp Adjusting Tools	496
Manual Impact Wrench Bits	285
Manual Impact Wrench Sets	285
Manual Staple Guns	914
Marker Pen for Tyres	837
Markers	837
Mats	850-851
MDF Wooden Panel Inserts for Workshop Trolley	70
Measurement Cables	822-824
Measuring Cup	757-758
Measuring Gripper with Cable Piercer	823
Measuring Tape	267
Measuring Tool Sets	42
Mechanics Creeper	847-850
Mechanics Gloves	900
Merchandise	916-920
Metal Bands Pliers	362
Metal Saw Blades	272

Description	Page
Metal Workshop Trolley	19-21,108,110
Micro Die Grinders (Air)	406-407
Microfibre Cloths	918
Micrometer	265
Micro-Pullers	212
Milling Drill Sets	225
Milter Boxes	273
Mini Bolt Cutters	371
Mini Drill Sets	224
Mini Grease Guns	765-766
Mini Locking Pliers	348
Mini Pliers	35,379
Mini Reversible Ratchets	183
Mirrors	775-776
Mobile Assembly Trolley	21
Mobile Assembly Trolley for Windscreens	568-569
Mobile Tables	22
Moisture Meter	914
Molly Bolt Assortment	887
Motorcycle Battery Disconnect Adaptors	453
Motorcycle Bit Sets	437
Motorcycle Chain Tools	439
Motorcycle Clutch Tools	453
Motorcycle Front Axle Alignment Tools	440-441
Motorcycle Lifters	454-455
Motorcycle Oil Filter Wrench	449-450
Motorcycle Special Sockets	437
Motorcycle Special Tools	436-455
Motorcycle Spring Compressors	436-437
Motorcycle Tyre Balancers	454
Motorcycle Tyre Levers	436
Motorcycle Variomatic Tools	453
Motorcycle Wheel Balancers	454
Motorcycle Wheel Bearing Tool Sets	443
Mounting Devices for Hose Tapes	363-364
Mounting Pastes for Tyres	840
Multi Purpose Drill Sets	228
Multi Sockets	128
Multimeter	825-829
Multimeter Test Leads	822-824
Multi-Purpose Oil Pumps	754-755
Multi-Purpose Tables	763
Multi-Screwdriver	76
Multitester	825-829

N

Nails for Manual Nail Guns	914
Navigation Device Disassembly Kits	491-492
Needle Files	235-236
Needle Pliers	381
Needle Scaler Heads for Compressed Air Chisels	420
Nibbler Sheet Shears	371
Nozzle Block Special Sockets	461
Nozzle Gauges	621
Numbers for Punching	235
Nut Assortment	881
Nut Extractors	118
Nut Splitter	268-269
Nuts	QF1-5,26-28
Nylon Brushes	229-231

O

OBD Reading Devices	499
Obstruction Ring Spanner Sets	309
Offset Screwdrivers	294
OHC Valve Spring Compressors	726
Oil Can	767
Oil Cannisters	780-781

Description	Page
Oil Dipsticks	806-807
Oil Drain Adaptor Hoses for Oil Filter	803
Oil Drain Plug Seal Rings	792
Oil Drain Plug Sockets	788-790
Oil Drain Thread Repair Kits	791
Oil Drip Pans	779-782
Oil Drum Attachments	782
Oil Drum Cart	778
Oil Drum Pumps	807-808
Oil Filler Tool Adaptors	786-788
Oil Filling Adaptors	786-788
Oil Filling Funnels	786-788
Oil Filter Caps	795-804
Oil Filter Chain Wrenches	793-794
Oil Filter Disassembly Tools	804
Oil Filter Drain Hoses	803
Oil Filter Grip Pliers	805
Oil Filter Pliers	805
Oil Filter Ratchet Ring Spanners	801
Oil Filter Strap Wrench	463,792-793
Oil Filter Wrench	785,795-804
Oil Filter Wrenches	792-793,803-804
Oil Filter Wrenches (Commercial Vehicle)	463
Oil Filter Wrenches (for utility Vehicles)	463
Oil Filter Wrenches (Motorcycle)	449-450
Oil Funnels	786-788
Oil Pan Cleaning Kits	778
Oil Pan Screws	792
Oil Pan Sealing Rings	792
Oil Pan Sockets	41,788-790
Oil Pans	779-782
Oil Pressure Test Kit	816
Oil Service Wrench	788-790,802
Oil Suction Devices	467-471,778,785
Oil Suction Pumps	807
Oiler	767
Oiler with flexible Nozzle	757-758
One-hand Grease Guns	765-766
One-hand Pipe Wrenches	356
One-hand Reversible Ratchets	185
Open End Spanner	QF13,31
Open End Spanner Sets	31,305-306,321
Open End Torque Wrench	205
O-ring Assortment	860-863
O-ring Mounting Hooks	589
O-rings for Impact Wrenches	390
OT Gauges for Ignition Adjustment	452
Overvoltage Protection	898
Oxygen Sensor Impact Loosening Wrench	130,595
Oxygen Sensor Ring Wrenches	322
Oxygen Sensor Sockets	130,596-597
Oxygen Sensor Thread Repair Kits	242

P

Panel Beating Irons	561,572
Panel Beating Tools	555,560,573-574
Panel Clips	852-859
Panel Removal Tools	587-588
Panel Removal Wedge Set	587
Paper Roll Holders	68,69
Parallel Bench Vices	324
Parallel Pullers	209-218
Parking Sensor Assembly Tools	562
Parts Cleaner	846-847
Parts Washer	846-847
PDC Assembly Tools	562
Pedestals	763
Perlon Cable	590

Description	Page
PH-Bits	QF9
Piercing Awls	496,567
Pin Punches	43,50,58,254-259
Pin Wrench	250
Pin Wrench for Suspension Joints	519-520
Pin Wrenches for Ball Joint	519-520
Pin Wrenches for Gearbox Flange	458
Pipe Connector for Bleeding Diesel Systems	470
Pipe Connector Loosening Clip Sets	615
Pipe Connector Removal Tools	615
Pipe Connector Sockets	127-128
Pipe Cutter	269-270
Pipe Pliers	356
Pipe Ratchet Wrenches	322-323
Pipe Reamer	270
Pipe Socket Wrench	321
Pipe Socket Wrench for Bumper	590
Pipe Thread Sealing	910
Pipe Threading Set	276
Pipe Wrenches	616
Piston Height Adjustment Tools	452
Piston Pin Disassembly Pliers	526
Piston Ring Pliers	753
Piston Ring Tension Bands	752
Plastic Case for Small Parts	332
Plastic Chisel	586
Plastic Mitre Boxes	273
Plastic Pads for Workshop Trolleys	70
Plastic Plug Assortment	887
Plastic Repair Kits	563,426-427
Plastic Rivet Assortment	858
Plastic Riveting Pliers	355
Plastic Scrapers	277-278
Pliers	341-385
Pliers for Earless Axle Boot Clamps	363
Pliers for Eyelets	377
Pliers for Fuel Line Connections	614-615
Pliers for Glow Plug Sockets	747
Pliers for Hose Clamps	357-362
Pliers for Metal Bands	362
Pliers for Piston Rings	753
Pliers for Valve Shims	729
Pliers for Valve Stem Seal Ring	728-729
Pliers Sets	36,49,54,58
Pliers Sets for Tool Boxes	112
Pliers Sets VDE	35
Pliers Type Multimeter	825-829
Plug Installing Tools for Tyre Repair	842
Pneumatic Dent Hammers	398
Pneumatic Special Oils	420
Pocket Gas Torch	915
Pole Terminal Pullers	583
Polisher Kits	279
Polishing Discs	279
Polishing Heads	278
Positioning Shells	888
Poster	918
Pouring Spout for Containers	757
Power Cable	431
Pre-Chamber Sockets	605
Precision Combination Pliers	379
Precision Diagonal Side Cutters	369
Precision Feeler Gauges	728
Precision Long Nose Pliers	380
Precision Mini Pliers	379
Precision Mini Pliers Sets	35
Precision Oilers	767
Precision Pliers Sets	35
Precision Round Nose Pliers	380

Description	Page
Precision Screwdriver T-Profile (for Torx)	285,293-294
Precision Screwdrivers	285,293-294
Precision Side Cutters	369
Precision Vernier Calliper	264
Press and Pull Sleeve Kits	534-535
Press Mandrels for Flaring Tools	464-466
Pressing Frame	554
Pressure Cleaners	417
Pressure Gauge for Tyres	837
Pressure Loss Testing Kit	817-819
Pressure Mandrel Flaring Tools	464-466
Pressure Piece Flaring Tools	464-466
Pressure Regulator for Compressors	422
Pressure Sprayers	754-755
Pre-Tensioning Tool for SAC Clutches	525
Probes	822-824
Promotional Items	916-918
Prop Shaft Separators	505
Prop Shaft Thread Repair Kits	242
Protection Sockets	114-116
Protective Impact Socket Sets	147-148
Protective Mats	850-851
Protective Plastic Cover for Protective Inserts	114-116
Protective Seat Covers	851
Protective Socket Sets	147-148
Protractor	266
Pry Bars	777
Puller for Common Rail Injectors	461,604-611
Pullers	209-218,896-897
Pump Nozzle Adjustment Gauges	710
Pump Nozzle Tools	608
Pump Sockets	622
Pump Sprocket Locking Tools	657
Pump Wheel Extractor	657
Pump Wheel Removal Tools	655
Pumps	754-755,764
Pumps for Oil Barrels	807-808
Punch Pliers	557-558
Punches	256
Punches for Brakes	486
Push Rod Separator	517
Push Type Clip Assortment	859
Push-through Bit Sets	78
Push-through Socket Sets	78,104
PZ-Bits	QF9

Q

Quad Jack	894
-----------	-----

R

Radio Removal Tool Sets	491-492
Ratchet Adaptors	189
Ratchet Combination Spanners Sets	32,55
Ratchet Head Repair Kits	190
Ratchet Joint Wrench	316
Ratchet Ring Spanner Adaptors	323
Ratchet Ring Spanner Sets	32,55
Ratchet Ring Spanners	314-319
Ratchet Ring Spanners (angled)	316,318
Ratchet Ring Spanners (open)	317-318
Ratchet Ring Spanners (reversible)	314-319
Ratchet Ring Wrench	314-319
Ratchet Ring Wrench for Oil Filter	801
Ratchet Rotary Handles	197
Ratchet Screwdrivers	393-394
Ratchet Sets	24,25,47,51,52,56,73-107
Ratchet Sets 12-point	80-81,96

Description	Page
Ratchet Sets Gear Lock	76,86,92,104
Ratchet Sets Inch Sizes	74,77,79,81,94
Ratchet Wrenches	23,47,76
Ratchet Wrenches, adjustable	316,318
Ratcheting Tool Holders	249
Ratchets	183-190
Ratchets for Bits	182,189-190
Ratchets for Scaffolders	189
Reamer Sets for Glow Plug Bores	749-750
Reamers	481
Reamers for ABS Sensors	481
Rear Axle Adjustment Tools	550
Rear Axle Bearing Tools	540-541
Rear Axle Bushing Tools	546-554
Rear Axle Guide Bushing Tools	544-545
Rear Axle Nut Spanner	459
Rear Window Washer Repair Kit Sets	581
Reinforced Hoses for Grease Guns	766
Relay Pliers	495
Release Pliers for Clips	578
Release Shaft Pullers	525
Release Tools	59
Release Tools for Airbags	495
Release Tools for Cable Connectors	493-494
Release Tools for Panelling	587-588
Release Tools for Wheel Nut Caps	839
Remover for Exhaust Pipe	598
Repair Kits for Brake Caliper Brackets	483-484
Repair Kits for Brake Calliper Bleed Valves	482
Repair Kits for Brake Threads	482
Repair Kits for Glow Plug Threads	748-752
Repair Kits for Oil Drain Threads	791
Repair Kits for Plastics	426-427
Repair Kits for Ratchet Ends	190
Repair Kits for Spark Plug Threads	743-744
Repair Kits for Threads	23,240-243
Repair Kits for Torque Wrenches	208
Repair Kits for Tyre Valves	844-845
Repair Mats	905
Repair Plugs	44
Repair Plugs for Tyres	841
Replacement Blades for Knife	261
Replacement Hose with Adaptor for Air Inflators	403
Replacement Locks for Workshop Trolley	71
Replacement Sleeves for Protective Inserts	114-116
Replacement Wheels for Workshop Trolley	72
Retaining Rings for Air Impact Wrench	390
Retractable Knives	45, 259-260
Reversible Ratchet for One Hand Operation	185
Reversible Ratchet Ring Spanner	314-319
Reversible Ratchet with Ball Head	188
Reversible Ratchet with Rotary Handle	187
Reversible Ratchet with Rotary Head	186
Reversible Ratchets	183-190
Reversible Ratchets with Interchangeable Handles	186
Reversible Ratchets, extendable	187
Revolving Punch Pliers	377
Rim Bore-Circle Callipers	835
Rim Lock Dismantling Socket Sets	125
Rim Lock Sockets	122-125
Rim Protective Socket Sets	147-148
Rim Protective Sockets	114-116
Ring Ratchet Wrenches	23,47
Ring Spanner Set	31,307-314
Ring Spanners	QF12-13,31,473-474
Ring Spanners (open)	41,42,312-314
Rivet Guns	353-354
Rivet Nut Attachments	355,876-877
Rivet Nut Heads	355
Rivet Nut Pliers	353-354

Description	Page
Riveters	353-354
Riveting Tools for Motorcycle Chains	439
Roll Base Sets for Drums	778
Roll Pin Assortment	872
Roller Cabinets	4-19
Roller Seat for Mechanics	847-850
Roll-up Bag for Tools	332
Roofing Hammers	253
Rotary Drum Pumps	807-808
Rotary Handle Reversible Ratchets	187
Rotor Counteracting Spanners	446
Rotor Pullers	444-446
Round Battery Terminals	810
Round Brush for Tyre Mounting Paste	839
Rubber Backing Disc	915
Rubber Grommet Assortment	870
Rubber Hammers	251-252
Rubber Hose Clamp Assortment	878

S

SAC Clutch Tools	523
Safety Bolt Assortment	871
Safety Cutter	45,259-260
Safety Glasses	902-903
Safety Helmets	903
Safety Masks	904
Sales Display Walls	919
Sales Displays	912,920
Sales Displays Socket / Bit Socket Sets	142
Sanding Discs	279-281
Sanding Pads	280
Sanding Tools	237
Sanitary Cross Wrench	274
Sanitary Wrench	274
Saw Blades	272
Saws	271-272
Scaffolding Ratchets	189
Scissor Sets	45
Scissors	262-263
Scraper Sets	60
Scrapers	277-278
Screw Assortment	880,882
Screw Doctor	909
Screw Extractor Set	QF5,116-122
Screw Hook Assortment	881
Screw Locking Fluid	909-910
Screw Pitch Gauges	250
Screw Punch	276
Screw Securing Wire	888
Screwdriver Bit Sets	182-183
Screwdriver Interchangeable Blade	287-288
Screwdriver Set for Tool Boxes	113
Screwdriver Sets	33-34, 48,49,54,57
Screwdriver Sets T-Star (for Torx)	285-288
Screwdrivers	282-295
Screwdrivers Cross Slot	282-285,288-290,294
Screwdrivers for Hose Clamps	132,364
Screwdrivers for Torx	33,48,57
Screwdrivers Internal Spline (for XZN)	283
Screwdrivers VDE	284-285,289,292
Screwdrivers with Flexible Round Handle	198
Screwdrivers with T-Handle	288,336,339-340
Screws for Oil Pans	792
Scriber	255
SDS Adaptors	194-195
SDS Bitholder	173
SDS Bit-Holder	173
SDS Socket Sets	194-195

Description	Page
Seal Removing Hooks	251
Seal Ring Assortments	860-869
Seal Ring Tools	713,715,717,720
Seal Tapes	873-874
Sealants	906,912
Sealing Rubber Looseners	587
Self Grip Pliers	347-352
Self-adjusting Water Pump Pliers	385
Sensor Simulators	498
Separating Pliers for BMW Oil Coolers	715
Serpentine Belt Tool	702
Setting Gauges for Gearboxes	526
Shaft Drive Belt Pulley Puller	713
Sharpeners for Saw Chains	281
Sheet Metal Rotary Shears	372
Sheet Metal Shears	261-262
Sheet Shears	261-262,371
Shock Absorber Counteracting Spanner	510
Shock Absorber Spanner	510
Shock Absorber Tools	508-509
Shopping Trolley Chips	917
Shrink Tube Assortment	882-883
Side Tables	22
Silent Block Tools	536-554
Silent Deflator	843
Silicon Puller	575
Single Compartment for Workshop Trolleys	71
Single L-Keys	340-341
Single Open End Spanner Sets	305
Sledge Hammers	254
Sliding Gauge	264
Sliding Gauge Accessories Sets	265
Sliding Hammer Extractor for Valve Stem Seal Ring	729
Sliding Hammer for Wheel Hub Pullers	502-503
Sliding Hammer Puller Feet	503
Sliding Hammer Puller Sets	503
Sliding Handle Adaptors	201
Sliding T-Bars	QF10
Slot Bit Socket Sets	154
Slot Bits	QF9
Slotted Screwdriver Sets	48,49,54,57
Slotted Screwdrivers	282-285,289-292,294
Small parts cassettes (empty)	332
Smart Repair	576
Socket Adaptors	QF10
Socket for Gear Locks	QF3
Socket Holding Rails	69
Socket Rails	196-197
Socket Sets	24,25,47,51,52,56,73-107,133-150,284,286
Socket Sets (12-point)	133-135,137-138,140-141,150
Socket Sets (E-Type)	136,142,146-147,150
Socket Sets (Gear Lock)	135,143,146
Socket Sets (Impact)	80
Socket Sets (Inch Sizes)	134-135,137-140,147
Socket Sets 12-point	80-81,96
Socket Sets for Tool Boxes	111
Socket Sets Gear Lock	76,86,92,104
Socket Sets Holding Rail (Magnetic)	69
Socket Sets Inch Sizes	74,77,79,81,94
Socket Sets Rails	196-197
Socket Sets with T-Handle	132-133
Socket Wrench Adaptors	QF10
Socket Wrench Adaptors for Drills	194-195
Sockets	QF1-5,26-28
Sockets E-Type (Torx)	QF4-5
Sockets for Axle Nuts	440
Sockets for Brake Callipers	456,483-484

Description	Page
Sockets for Diesel Filters	619
Sockets for Drills	227-228
Sockets for Drive Shafts	505
Sockets for Glow Plugs	744-746
Sockets for Injection Lines	605-606
Sockets for Injection Pumps	618,622
Sockets for Injectors	602
Sockets for Oil Drain Plugs	788-789
Sockets for Oil Pans	41,788-790
Sockets for Oxygen Sensors	596-597
Sockets for Pre-Chambers	605
Sockets for Socket Sets	QF1-5,26-28
Sockets for Spare Tyre Locks	839
Sockets for Spark Plugs	736-740
Sockets for Struts	510
Sockets for Thermo Switches	597
Sockets for Track Rod Ball Head	532
Sockets Sets Sales Displays	142
Sockets, 12-point	QF1-5,26
Sockets, Hexagon	QF1-5,26-28
Sockets, Inch sizes	QF1-2
Soft Head Hammers	252,254,845
Soldering Aid Pliers	378
Soldering Connector Assortment	876
Soldering Iron	431,915
Soldering Stations	428
Sorting Inlays	22
Spanners	QF11-13, 320-323
Spanners for Air Filters	804
Spanners for Belt Pulleys	731-732
Spanners for Brake Lines	472-473
Spanners for Spark Plugs	736-740
Spanners for Tensioner Pulleys	730-732
Spanners Glow Plugs	744-746
Spark Plug Brushes	743
Spark Plug Cleaning Brush	231,743
Spark Plug Pliers	740-741
Spark Plug Socket Puller	453,741
Spark Plug Sockets	736-740
Spark Plug Thread Repair Kits	743-744
Spark Plug Wrench	736-740
Splate	913
Special Adhesive	906-908
Special Exhaust Clamp Pliers	598
Special Extension Bars	191-192
Special Screwdrivers	295
Special Shape Ratchets	188
Special Shape Ratchets with T-Handle	186
Special Socket Sets	116-118
Special Sockets	QF5,41,128-131
Special Sockets for Axle Nuts	440
Special Sockets for Camshafts	451-452
Special Sockets for Elbow Connectors	127-128
Special Sockets for Motorcycles	437
Special Spanners	320-323
Special Wheel Bolt Sockets	114-116
Spindles for Brake Piston Wind Back Sets	479
Spinner Handles	197-198
Spline (for XZN)	QF9,171
Spline Bit Socket Sets	152,155,160-163
Spline Bit Socket Sets (for RIBE)	163-164
Spline Bit Sockets	QF6,QF8
Spline Bit Sockets (for RIBE)	QF7-8
Spline Bits (for RIBE)	QF9
Spline Impact Bit Socket Sets	152,155,160-163
Spline L-key Sets (for RIBE)	339
Spline Screwdrivers (for XZN)	283
Spline Sockets (for RIBE)	129
Splitting Axes	218
Spoke Torque Wrench	441

Description	Page
Spoke Wrench (Motorcycle)	441
Spot Weld Cutters	238
Spot Weld Drills	238
Spot Welding Clamps	350-351
Spot Welding Cutter	398
Spray Can Trays	68
Spreader for Ball Joints	516
Spreader Socket for Spring Strut Clamps	509
Spring Assortment	872-873
Spring Band Clamp Pliers	66,357-358,360
Spring Clamp Pliers for Fuel Lines	358
Spring Compressors	511-512
Spring Compressors for Exhaust	598
Spring Compressors for Motorcycles	436-437
Spring Cotter Pin Assortment	870-871
Spring Plate Pliers	490
Spring Retainer for Spring Compressors	512
Spring steel Hose Clamp Clamping Tools	358
Spring Strut Sockets	510
Spring Strut Spreader Sockets	509
Spring Strut Tools	507
Spring Washer Assortment	865
Spud Wrench	273-274
Square Cutting Wire for Car Glass Removal	565-566
Stabiliser Ball Joint Tools	515
Stainless Steel Brushes	231
Stainless Steel Cutting Discs	282
Stainless Steel Hose Clamp Assortments	877-878
Stainless Steel Tweezers	378
Stands for Windscreens	568-569,763
Staple Gun	914
Staple Gun Bolts	914
Staples	914
Staples for Manual Staple Gun	914
Star Punch	235
Starter Socket Wrench Sets	309
Steel Bench Vices	324
Steel Brushes	229-234
Steel Cable Cutters	371
Steel Line Stopper Sets	367
Steering Head Bearing Remover	444
Steering Head Mounting Tool Sets	443
Steering Tools	527
Steering Wheel Levels	533
Steering Wheel Protective Cover	851
Steering Wheel Puller	216
Steering Wheel Sleeve Pullers	531
Step Drill Sets	221,226
Step Drills	38,328,330
Stethoscope	831-832
Stickers	920
Stitch Awl	44
Stitch Awl for Tyre Repair	842
Stoning Hammers	43,251
Stoppers	367
Storage Trays	46,47
Storage Trays for Workshop Trolleys PRO	71
Straight Edge	821
Strap Wrench	713-714
Stripping Pliers	39,40,341-343,368
Stroboscopic Guns	497
Stud Bolt Cleaning Brush	234
Stud Bolt Extractor Sets	118
Stud Extractors	326-328
S-Type Spanner Sets	310
Suction jets	754-755
Suction Lifters	569-571
Suction Valve Grinders	730
Superglue	906-908
Surface Sealing	911

Description	Page
-------------	------

Swivel Castor Wheels for Workshop Trolley	72
Swivel Joint Handle	QF10,200
Synchronous Carburetor Testers	453

T

Tachometers	499
Taillight Disassembly Tools	495
Tank Sensor Wrenches	616-618
Tap and Die Sets	238-248
Tap Sets	227,238-248
Tap Wrench	248-249
Tapes Measures	267
Taps	238-239
TDC Finder	690
Telephone Pliers	380-382
Telescope Mirror	776
Telescopic Support for Trunk Lid	580
Tensioner Pulley Wrench	701,730-732
Tensioning Guns for Cable Ties	378
Tensioning Tool for Spring Band Hose Clamps	358
Terminal Tool Kits	494
Test Leads	822-824
Tester for Oil Pressure	816
Tester fro Trailer	895-896
Testers for Air Conditioning Systems	814
Testers for Diesel Injection Nozzles	613-614
Testers for Glow Plugs	824
Testing Tools for Turbo Charger Systems	461, 723-724
T-Handle Screwdrivers	58,288,336,339-340
T-Handle Socket Sets	57,132-133
T-Handle Spanners	333,336
T-Handles	198-199
Theft Protection Sockets	122-125
Thermo Switch Sockets	597
Thermometer	832-833
Thread Files	239
Thread Repair Kits	23,240-243
Thread Repair Kits for Drive Shaft	504
Thread Restorer Files	239
Thread Sealings	910
Threading Die	238-239
Threading Die Clamping Tool Sets	250
Tie Rod Joint Tools	527-530
Tie Rod Separators	517
Tie Rod Spherical Head Sockets	532
Tile Carrying Handles	913
Tile Drill Bit Sets	219
Tile Drill Bits	219
Timing Chain Riveting Tools	716
Timing Chain Tensioner Lever	720
Tips for Grease Guns	766
Tire Deflating Caps for "TPMS" Valves	838
Toilet Installation Wrenches	274
Tool Bags	332
Tool Boxes (empty)	19-21,331
Tool Exhibition Walls	919
Tool Holders for Taps	249
Tool Roll-up Bag	109
Tool Sets	105-113
Tool Sets for Axial Joints	529
Tool Trolleys	4-19
Tool Walls	919
Tools for Hose Clamps	357-362
Toothbelt Gauge	732
Toothed Belt Pulley Holders	690
Toothed Belt Wheel Pullers	217
Torque Adaptors	207
Torque Multipliers	206

Description	Page
-------------	------

Torque Screwdriver for Valve Cores	844
Torque Setting Angular Gauges	207-208
Torque Tools	202-208
Torque Wrench	202-205
Torque Wrench Repair Kits	208
Torque Wrenches	202,205
Torsion Bars	207
Tow Ropes	895
Towing Braces	895
Towing Vehicle Testers	895-896
TPMS Tool Sets	836
Trailer Tester	895-896
Trailing Arm Bushing Tools	545
Trailing Arm Silent Block Tools	546
Transmission Oil Filling Tool Adaptors	783-785
Transmission Oil Filling Tools	783-785
Transport Trolley for Tyres	842
Tread Depth Gauges	836
Trim Strip Wedge Sets	60
Trim Strip Wedges	59,585,587
Trolley	4-19
Truck Bit Sets	175
Truck Cross Wrench	457-458
Truck Four Way Wheel Wrenches	457-458
Truck Oil Filter Wrench	463
Truck Socket Tools	458
Truck Strap Wrenches	463
Truck Tools	456-463
Truck Tyre Mounting Lever	457
Truck Tyre Transporter	890
Truck Tyre Trolley	842
Trucks Bit Set	175
Trunk Lid Telescopic Supports	580
Trunk Mats	898
Trunk Opener Locking Clamp	580
T-Shirts	916
T-Star (for Torx plus) L-Key Sets	339
T-Star (for Torx Plus) Bit Socket Sets	171
T-Star (for Torx) Bit Socket Sets	151-154,165-171
T-Star (for Torx) Extractor Sets	121
T-Star Bit Socket Sets (for Torx Plus)	171
T-Star Bit Sockets	QF6
T-Star Bit Sockets (for Torx)	QF6-8
T-Star Bits (for Torx)	QF9, 171-172
T-Star L-Key Sets (for Torx)	336-341
T-Star Precision Screwdriver Sets (for Torx)	285,293-294
T-Star Screwdriver Sets (for Torx)	33,48,57
T-Star Screwdrivers (for Torx)	285-288
T-Star Spanners	58
Tube Bending Pliers	466-467
Tube Cutter for Exhaust Pipes	595
Tufted Wire Brushes	233
Turbocharger System Test Sets	461
Turbocharger Test Sets	723-724
Turbocharger Tools	723-724
Turn Off Sockets for Glow Plug Electrodes	746
Tweezers	378
Twist Drill Sets	219-227
Twist Sockets	116-118
Tyre Bead Retainer	838-839
Tyre Boosters	837
Tyre Change Insert	59
Tyre Depth Gauge	836
Tyre Inflation Gun Hoses	403
Tyre Levers	456,840-841
Tyre Levers (for Motorcycle)	436
Tyre Locking Mechanism Sockets	839
Tyre Marker Pens	837
Tyre Mounting Paste Brush	839

Description	Page
Tyre Mounting Pastes	840
Tyre Pressure Gauges	837
Tyre Pressure Monitoring System Tool Sets	836
Tyre Repair Kit Sets	44
Tyre Repair Kits	841-842
Tyre Repair Plugs	841
Tyre Service Inserts	59
Tyre Transporter for Truck Tyres	890
Tyre Valve Cutting Tools	844-845
Tyre Valve Puller	843-844
Tyre Valve Repair Kits	844-845

U

Ultrasonic Cleaner	905
Ultrasonic Leak Testers for Gas, Air and Water Containers	816
Ultrasonic Parts Cleaner	846-847
Universal Cleaners	905
Universal Drill Chuck Keys	229
Universal Joint Socket Sets	135,138
Universal Joint Sockets	114
Universal Joints	199-200
Universal Knives	259-260
Universal Shears	262-263
Universal Spanners	275-276
Universal Support Hook	773
Universal Wrenches	320
Unlocking Tool for Brake Shoe Spring	489
Unlocking Tools Brake Pedal	486
Upholstery Clip Pliers	378
Urea Filling Tubes	756
U-Type Cushion Assortments	880

V

Vacuum Body Repair Sets	573-574
Vacuum Guns	833
Vacuum Pressure Pumps	833
Valve Core Torque Tools	844
Valve Cutters	729-730,844-845
Valve Lapping Tool Attachment	730
Valve Mounting Tools	724-727
Valve Repair Kits	844-845
Valve Retraction Tools	843-844
Valve Shim Remover	727
Valve Shim Removers	727
Valve Shims Pliers	729
Valve Spring Compressor Sets	447
Valve Spring Compressors	724-727
Valve Spring Compressors for OHC	726
Valve Stem Seal Mounting Tools	451
Valve Stem Seal Ring Pliers	728-729
Valve Stem Seal Ring Sliding Hammer Extractors	729
Valve Wedge Removing Tools	728
Variomatic Tools (Motorcycle)	453
V-belt Disassembly Tools	731-735
V-Belt Installation Tool Kit	731-735
V-Belt Timing Belt Wrenches	702
VDE Insulating Tape Rolls	873-874
VDE Knives	263
VDE Pliers	383-384
VDE Pliers Sets	35,58
VDE Screwdriver Sets	34
VDE Screwdrivers	284-285,289,292
VDE Side Cutters	370
VDE Single Open End Spanner Sets	305
VDE Stripping Pliers	341
VDE Water Pump Pliers	385
VE Pump Sockets	622
Vernier Caliper, Digital Type	264

Description	Page
Voltage Tester	825-831

W

Washer Assortment	866
Washing Appliances for Small Parts	846-847
Water Pump Belt Pulley Holders	713
Water Pump Disassembly Tools	715
Water Pump Pliers	277,384-385
Water Pump Pliers Sets	36
Water Remover	575
WC Seat Installation Wrenches	274
Weights for balancing	834-835
Welding Clamp	350-351
Welding Goggles	902
Welding Helmets	901-902
Wheel Arch Flanging Pliers	556
Wheel Balancing Weight Pliers	834
Wheel Balancing Weights	834-835
Wheel Bearing Hub Unit Installing Tools	535
Wheel Bearing Inner Ring Puller	554
Wheel Bearing Ring Pullers	554
Wheel Bearing Tool Sets (Motorcycle)	443
Wheel Bearing Tools	534-554
Wheel Bolt Sockets	114-116
Wheel Camber Adjustment Tools	530
Wheel Cross Slot (Car)	533
Wheel Hub Pullers	460,500-503
Wheel Hub Retaining Tool	503
Wheel Hub Tools	538
Wheel Nut Bolt Cleaning Brushes	234
Wheel Nut Cap Loosening Tools	839
Wheel Stud Mounting Sets	838
Wheel Stud Repair Kits	241
Wheel Stud Repair Tool	241
Wheeled Kneeboards	850-851
Wheels for Workshop Trolley	72
Winches	896-897
Wind Back Adaptor for Brake Pistons	478-479
Wind Back Kits for Brake Pistons	50,456
Wind Back Tools for Brake Pistons	475-481
Wind Back Tools for SAC Clutches	524
Window Cutting Wires	565-566
Window Seal Cutter Tools	564-567
Window Seal Cutters	565-566
Windowpane Installation Rollers	567
Windscreen Carriers	569-571
Windscreen Carrying Tool Carts	568-569
Windscreen Mounting Frames	568-569
Windscreen Tools	564-567
Windscreen Wiper Adjustment Tools	584
Windscreen Wiper Arm Pullers	581-584
Windshield Seal Nylon Cutting Wire	566
Windshield Stand	568-569,763
Wing Nut Assortment	881
Wire Brush	229-234
Wire Spoke Wrench	442
Wire Stripper	343
Wire Strippers	342-343
Wire-piercing Probes	567
Wishbone Bushing Tools	544-545,548-549
Wishbone Hydro Bearings Tools	544-545
Wishbone Lever Tools	506-507
Wobble Extension Bar Sets	191-193
Wood Crown and Milling Drill Sets	225
Wood Drill Sets	225
Wooden Folding Rulers	267
Wooden Inserts for Workshop Trolley	70
Woodruff Key Assortment	887
Work Gloves	900

Description	Page
Working Lamps	767-772
Working mats	850-851
Working Platforms	763
Workshop Creepers	847-850
Workshop Files	235-236
Workshop Gloves	900
Workshop Lights	769-772
Workshop Press	894
Workshop Seats	849
Workshop Trolley Attachments	19-20
Workshop Trolley Locks	71
Workshop Trolley Supports	70
Workshop Trolley Tool Trays	22-66
Workshop Trolley Tool Trays (empty)	22-65
Workshop Trolley Tool Trays 1/3	24-47
Workshop Trolley Tool Trays 1/6	22-23
Workshop Trolley Tool Trays 2/3	47-50
Workshop Trolley Tool Trays 3/3	51-65
Workshop Trolley Trays	70
Workshop Trolley Wheel Bases	72
Workshop Trolley Wheels	72

X,Y,Z

Yardsticks	267
------------	-----

Art.		BGS/ KM
8	916	BGS
16	916	BGS
18	916	BGS
19	916	BGS
47	359	BGS
49	919	BGS
49-2	919	BGS
49-3	919	BGS
49-5	919	BGS
49-6	919	BGS
49-7	919	BGS
49-8	n/a	BGS
57	919	BGS
57-1	919	BGS
57-2	919	BGS
62	188	KM
68	n/a	KM
72	831	BGS
90	73	KM
93-1	35	KM
93-2	35	KM
93-3	35	KM
93-4	35	KM
93-6	35	KM
93-7	35	KM
94	32	KM
98	203	BGS
98-LEER	n/a	BGS
101	237	BGS
105	187	BGS
106	187	BGS
107	187	BGS
110	221	BGS
111	237	BGS
112	188	BGS
113	188	BGS
114	188	BGS
115	182	BGS
116	221	BGS
117	10_18	BGS
118	714	BGS
120	595	BGS
121	599	BGS
123	791	BGS
124	127	KM
126	791	BGS
126-BM13	791	BGS
126-BM15	791	BGS
126-BM17	791	BGS
126-BM20	791	BGS
126-SM13	791	BGS
126-SM15	791	BGS
126-SM17	791	BGS
126-SM20	791	BGS
126-UM13	791	BGS
126-UM15	791	BGS
126-UM17	791	BGS
126-UM20	791	BGS
127	595	BGS
128	595	BGS
129	595	BGS

Art.		BGS/ KM
130	596	BGS
133	596	BGS
133-Kette	596	BGS
134	596	BGS
136	750	BGS
137	123	KM
138-1	750	BGS
138-2	750	BGS
138-3	750	BGS
142	123	KM
143	737	BGS
144	737	BGS
146	737	BGS
148	483	BGS
148-1	483	BGS
148-2	483	BGS
148-3	483	BGS
149	744	BGS
149-1	744	BGS
149-11	744	BGS
149-16	744	BGS
149-19	744	BGS
150	744	BGS
150-1	744	BGS
151	791	BGS
152	744	BGS
153	791	BGS
155	511	BGS
156	791	BGS
157	791	BGS
158	791	BGS
159	791	BGS
161	363	BGS
162	417	BGS
163	362	BGS
164	507	BGS
165	744	BGS
165-1	744	BGS
166	744	BGS
166-1	744	BGS
167	744	BGS
167-1	744	BGS
168	791	BGS
170	115	KM
171	QF10	BGS
172	QF10	BGS
173	QF10	BGS
174	QF10	BGS
176	190	BGS
177	190	BGS
178	190	BGS
179	190	BGS
180	190	BGS
182	190	BGS
183	190	BGS
184	190	BGS
185	207	BGS
185-120	207	BGS
185-135	207	BGS
185-150	207	BGS
186	207	BGS

Art.		BGS/ KM
187	207	BGS
188	200	BGS
189	200	BGS
190	200	BGS
191	192	BGS
192	192	BGS
193	192	BGS
194	192	BGS
195	QF10	BGS
196	QF10	BGS
197	200	BGS
198	194	BGS
199	195	BGS
199-LEER	n/a	BGS
200	196	BGS
200-LEER	n/a	BGS
205	138	BGS
206	201	BGS
209	183	BGS
210	183	BGS
211-REPAIR	190	BGS
212	183	BGS
213	07_18	BGS
213-REPAIR	02_19	BGS
215	183	BGS
216	198	BGS
217	197	BGS
220	135	BGS
221	28	KM
227	183	BGS
228	200	BGS
228-1	200	BGS
231	185	BGS
232	185	BGS
232-REPAIR	190	BGS
233	QF10	BGS
234	QF10	BGS
235	QF10	BGS
236	QF10	BGS
239	198	BGS
242	QF10	BGS
243	QF10	BGS
244	QF10	BGS
246	QF10	BGS
247	QF10	BGS
248	QF10	BGS
249	QF10	BGS
250	199	BGS
251	199	BGS
252	199	BGS
258	200	BGS
263	QF10	BGS
263-1	201	BGS
264	QF10	BGS
265	QF10	BGS
265-REPAIR	QF10	BGS
266	QF10	BGS
267	QF10	BGS
267-REPAIR	QF10	BGS
268	QF10	BGS
269	QF10	BGS

Art.		BGS/ KM
270	QF10	BGS
271	QF10	BGS
272	QF10	BGS
273	QF10	BGS
274	QF10	BGS
275	QF10	BGS
276	QF10	BGS
277	QF10	BGS
279	QF10	BGS
280	QF10	BGS
283	QF10	BGS
283-1	QF10	BGS
284	174	BGS
285	188	BGS
286	188	BGS
287	188	BGS
288	201	BGS
289	201	BGS
290	174	BGS
291	174	BGS
292	174	BGS
293	174	BGS
294	QF10	BGS
295	QF10	BGS
296	QF10	BGS
299	199	BGS
300	185	BGS
300-1	185	BGS
300-REPAIR	190	BGS
301	28	KM
302	184	BGS
303	184	BGS
304	184	BGS
305	189	BGS
306	189	BGS
307	189	BGS
308	189	BGS
309	189	BGS
310	189	BGS
311	189	BGS
312	189	BGS
313	189	BGS
313-1	04_19	BGS
314	273	BGS
315	184	BGS
316	184	BGS
317	184	BGS
318	184	BGS
319	184	BGS
320	184	BGS
321-REPAIR	190	BGS
322-REPAIR	190	BGS
323-REPAIR	190	BGS
324	184	BGS
325	93	KM
326	93	KM
327	93	KM
329	91	KM
330	94	KM
331	90	KM
332	90	KM

Art.		BGS/KM
333	91	KM
334	91	KM
335	91	KM
336	93	KM
337	93	KM
338	93	KM
339	86	KM
340	94	KM
341	381	BGS
342	98	KM
353	189	BGS
354	189	BGS
355	185	BGS
355-REPAIR	190	BGS
356	185	BGS
356-REPAIR	190	BGS
357-REPAIR	190	BGS
358	380	BGS
360	466	BGS
361	341	BGS
363	277	BGS
364	277	BGS
364-12	277	BGS
364-16	277	BGS
364-16x53	277	BGS
364-20	277	BGS
364-LEER	277	BGS
365	277	BGS
366	278	BGS
367	277	BGS
368	587	BGS
369	381	BGS
370	381	BGS
371	381	BGS
372	QF10	BGS
373	382	BGS
374	QF10	BGS
375	QF10	BGS
376	QF10	BGS
377	QF10	BGS
378	381	BGS
379	230	BGS
379-LEER	230	BGS
380	379	BGS
381	369	BGS
382	380	BGS
383	380	BGS
384	369	BGS
385	371	BGS
386	380	BGS
387	369	BGS
388	381	BGS
389	381	BGS
393	369	BGS
394	369	BGS
395	370	BGS
396	370	BGS
397	370	BGS
398	89	KM
400	88	KM
401	88	KM

Art.		BGS/KM
401-LEER	n/a	BGS
402	354	BGS
402-2	354	BGS
403	88	KM
404	04_18	BGS
405	353	BGS
405-1	353	BGS
405-2	353	BGS
405-3	353	BGS
405-4	353	BGS
405-LEER	n/a	BGS
405-M4	353	BGS
405-M5	353	BGS
405-M6	353	BGS
405-M8	353	BGS
405-M10	353	BGS
405-ZANGE	353	BGS
406	355	BGS
407	355	BGS
408	354	BGS
409	354	BGS
409-1	354	BGS
410	94	KM
411	95	KM
412	95	KM
413	95	KM
414	379	BGS
415	95	KM
416	96	KM
418	342	BGS
421	121	KM
423	95	KM
424	382	BGS
428	374	BGS
429	374	BGS
432	374	BGS
433	164	KM
434	374	BGS
439	362	BGS
441	86	KM
442	342	BGS
443	87	KM
444	372	BGS
445	375	BGS
446	375	BGS
447	373	BGS
447-1	01_19	BGS
447-2	01_19	BGS
447-3	01_19	BGS
447-4	01_19	BGS
449	375	BGS
450	373	BGS
450-1	01_19	BGS
450-2	01_19	BGS
450-3	01_19	BGS
450-4	01_19	BGS
453	373	BGS
454	92	KM
457	384	BGS
457-2	384	BGS
457-TASCHE	384	BGS

Art.		BGS/KM
461	98	KM
463	379	BGS
466	360	BGS
467	122	KM
470	359	BGS
471	361	BGS
472	359	BGS
473	358	BGS
474	350	BGS
475	350	BGS
476	350	BGS
477	359	BGS
478	373	BGS
479	505	BGS
480	352	BGS
482	352	BGS
484	352	BGS
485	349	BGS
486	368	BGS
487	368	BGS
489	96	KM
490	96	KM
491	352	BGS
492	368	BGS
493	348	BGS
494	348	BGS
495	351	BGS
496	350	BGS
497	350	BGS
499	360	BGS
504	66	BGS
504-1	02_19	BGS
505	348	BGS
506	349	BGS
507	350	BGS
508	92	KM
517	28	KM
518	28	KM
519	28	KM
525	356	BGS
526	356	BGS
527	356	BGS
528	356	BGS
530	375	BGS
531	376	BGS
533	370	BGS
534	382	BGS
535	382	BGS
540	356	BGS
541	356	BGS
542	356	BGS
543	356	BGS
544	356	BGS
551	382	BGS
552	382	BGS
555	383	BGS
556	383	BGS
557	383	BGS
561	377	BGS
562	276	BGS
564	377	BGS

Art.		BGS/KM
565	913	BGS
566	914	BGS
568	90	KM
569	90	KM
569-1	90	KM
570	90	KM
570-1	90	KM
572	377	BGS
572-LEER	377	BGS
600-REPAIR	10_18	BGS
601	10_18	BGS
601-REPAIR	10_18	BGS
602	10_18	BGS
602-REPAIR	10_18	BGS
610	10_18	BGS
611	10_18	BGS
612	10_18	BGS
650	373	BGS
650-1	01_19	BGS
650-2	01_19	BGS
650-3	01_19	BGS
650-4	01_19	BGS
651	373	BGS
651-1	01_19	BGS
651-2	01_19	BGS
651-3	01_19	BGS
651-4	01_19	BGS
652	02_19	BGS
652-1	02_19	BGS
652-2	02_19	BGS
652-3	02_19	BGS
652-4	02_19	BGS
710	285	BGS
711	285	BGS
712	74	KM
721	113	KM
723	830	BGS
724	830	BGS
725	830	BGS
726	113	KM
728	65	KM
729	64	KM
730	282	BGS
731	292	BGS
732	290	BGS
757	179	BGS
759	23	KM
762	181	BGS
763	23	KM
765	180	BGS
765-LEER	n/a	BGS
773	333	BGS
777	339	BGS
784	181	BGS
786	181	BGS
787	64	KM
790	334	BGS
790-1.5	340	BGS
790-2	340	BGS
790-2.5	340	BGS
790-3	340	BGS

Art.		BGS/ KM
790-4	340	BGS
790-5	340	BGS
790-6	340	BGS
790-7	340	BGS
790-8	340	BGS
790-9	340	BGS
790-10	340	BGS
791	62	KM
793	337	BGS
794	337	BGS
794-T10	341	BGS
794-T15	341	BGS
794-T20	341	BGS
794-T25	341	BGS
794-T27	341	BGS
794-T30	341	BGS
794-T40	341	BGS
794-T45	341	BGS
794-T50	341	BGS
795	332	BGS
797	70	KM
797-LEER	n/a	BGS
798	136	KM
799	335	BGS
800	339	BGS
802	334	BGS
803	69	KM
805	338	BGS
807	335	BGS
808	334	BGS
809	338	BGS
810	63	KM
815	63	KM
816	68	KM
829	326	BGS
830	326	BGS
841	326	BGS
843	326	BGS
845	326	BGS
850	253	BGS
851	253	BGS
852	253	BGS
853	253	BGS
854	253	BGS
855	253	BGS
856	253	BGS
857	253	BGS
858	253	BGS
865	574	BGS
865-1	574	BGS
865-2	574	BGS
865-3	574	BGS
865-4	577	BGS
865-5	577	BGS
865-6	575	BGS
865-7	575	BGS
867	574	BGS
868	426	BGS
873	427	BGS
873-1	427	BGS
873-2	427	BGS

Art.		BGS/ KM
873-3	427	BGS
873-4	02_19	BGS
873-5	02_19	BGS
873-6	02_19	BGS
873-7	02_19	BGS
873-8	02_19	BGS
874	574	BGS
875	398	BGS
890	252	BGS
891	252	BGS
892	252	BGS
900	245	BGS
901	247	BGS
930	238	BGS
931	238	BGS
932	238	BGS
933	238	BGS
934	238	BGS
935	238	BGS
936	238	BGS
940	248	BGS
941	248	BGS
942	248	BGS
943	248	BGS
944	248	BGS
945	249	BGS
946	249	BGS
954	203	BGS
956	202	BGS
958	205	BGS
958-REPAIR	208	BGS
958-LEER	n/a	BGS
959	203	BGS
959-REPAIR	208	BGS
960	203	BGS
961	205	BGS
962	203	BGS
963	30	KM
964	203	BGS
964-LEER	n/a	BGS
965	203	BGS
965-LEER	n/a	BGS
965-REPAIR	208	BGS
965-1	208	BGS
965-2	208	BGS
966	203	BGS
966-REPAIR	208	BGS
967	203	BGS
967-REPAIR	208	BGS
968	203	BGS
968-REPAIR	208	BGS
968-1	208	BGS
968-2	208	BGS
969	203	BGS
969-REPAIR	208	BGS
970	203	BGS
970-REPAIR	208	BGS
971	203	BGS
971-REPAIR	208	BGS
973	205	BGS
973-REPAIR	208	BGS

Art.		BGS/ KM
975	202	BGS
977	207	BGS
978	207	BGS
979	207	BGS
980-1	n/a	BGS
985	512	BGS
987	30	KM
988	30	KM
990	203	BGS
991	436	BGS
992	437	BGS
997	799	BGS
998	800	BGS
1000	123	KM
1001	617	BGS
1002	794	BGS
1004	725	BGS
1006	790	BGS
1007	798	BGS
1008	792	BGS
1009	796	BGS
1010	806	BGS
1010-A	806	BGS
1010-B	806	BGS
1010-C	806	BGS
1010-D	806	BGS
1011	793	BGS
1012	790	BGS
1014	788	BGS
1015	789	BGS
1016	789	BGS
1017	789	BGS
1019	463	BGS
1019-1	463	BGS
1019-2	463	BGS
1019-36	463	BGS
1019-74	463	BGS
1019-106	463	BGS
1019-107	463	BGS
1019-108	463	BGS
1019-108-18	463	BGS
1019-135	463	BGS
1020	124	KM
1021	124	KM
1022	124	KM
1023	124	KM
1024	732	BGS
1025	793	BGS
1026	733	BGS
1027	793	BGS
1028	793	BGS
1029	793	BGS
1030	804	BGS
1031	803	BGS
1032	804	BGS
1033	794	BGS
1034	124	KM
1035	125	KM
1035-75x12	125	KM
1036	798	BGS
1037	796	BGS

Art.		BGS/ KM
1038	805	BGS
1039	795	BGS
1039-65-67	795	BGS
1039-66-6	795	BGS
1039-68-14	795	BGS
1039-73-14	795	BGS
1039-74-15	795	BGS
1039-74-76	795	BGS
1039-75-77	795	BGS
1039-76-8	795	BGS
1039-76-12	795	BGS
1039-76-30	795	BGS
1039-78-15	795	BGS
1039-80-15	795	BGS
1039-80-82	795	BGS
1039-86-16	795	BGS
1039-86-18	795	BGS
1039-90-15	795	BGS
1039-92-10	795	BGS
1039-93-15	795	BGS
1039-93-36	795	BGS
1039-93-45	795	BGS
1039-95-15	795	BGS
1039-96-18	795	BGS
1039-106-15	795	BGS
1039-108-15	795	BGS
1039-108-18	795	BGS
1039-ADAPT	795	BGS
1039-LEER	795	BGS
1039-SPINNE	795	BGS
1041	798	BGS
1042	798	BGS
1043	449	BGS
1044	801	BGS
1045	798	BGS
1046	798	BGS
1047	798	BGS
1048	802	BGS
1049	804	BGS
1050	125	KM
1051	125	KM
1052	806	BGS
1053	799	BGS
1054	793	BGS
1056	QF11	BGS
1057	QF11	BGS
1058	QF11	BGS
1059	QF11	BGS
1060	QF11	BGS
1061	QF11	BGS
1062	QF11	BGS
1063	QF11	BGS
1064	QF11	BGS
1065	QF11	BGS
1066	QF11	BGS
1067	QF11	BGS
1068	QF11	BGS
1069	QF11	BGS
1070	QF11	BGS
1071	QF11	BGS
1072	QF11	BGS

Art.		BGS/ KM
1074	QF11	BGS
1075	QF11	BGS
1076	QF11	BGS
1077	QF11	BGS
1080	QF11	BGS
1082	QF11	BGS
1084	QF11	BGS
1086	QF11	BGS
1088	QF11	BGS
1091	QF11	BGS
1096	QF11	BGS
1100	QF11	BGS
1101	481	BGS
1102	50	BGS
1104	456	BGS
1105	128	BGS
1106	479	BGS
1107	81	BGS
1109	110	KM
1110	110	KM
1111	511	BGS
1112	484	BGS
1112-1	484	BGS
1113	481	BGS
1114	477	BGS
1114-1	476	BGS
1117	478	BGS
1117-LEER	478	BGS
1118	479	BGS
1119	475	BGS
1119-1	479	BGS
1119-LEER	475	BGS
1120	480	BGS
1121	480	BGS
1122	487	BGS
1123	480	BGS
1124	482	BGS
1126	481	BGS
1127	475	BGS
1134	513	BGS
1134-1	513	BGS
1134-10	513	BGS
1134-20	513	BGS
1134-25	513	BGS
1134-30	513	BGS
1134-50	513	BGS
1134-60	513	BGS
1134-70	513	BGS
1134-75	513	BGS
1134-80	513	BGS
1134-85	513	BGS
1134-90	513	BGS
1134-95	513	BGS
1134-100	513	BGS
1134-108	513	BGS
1134-110	513	BGS
1135	490	BGS
1136-1	n/a	BGS
1136-2	n/a	BGS
1138	598	BGS
1139	598	BGS

Art.		BGS/ KM
1140	130	BGS
1140-LEER	597	BGS
1140-22	130	BGS
1140-27	130	BGS
1141	242	BGS
1141-LEER	242	BGS
1142	599	BGS
1144	512	BGS
1145	754	BGS
1146	754	BGS
1147	754	BGS
1148	130	BGS
1149	597	BGS
1150	66	BGS
1151	67	BGS
1155	754	BGS
1156	754	BGS
1157	754	BGS
1158	68	BGS
1159	68	BGS
1173	598	BGS
1174	436	BGS
1175	323	BGS
1176	323	BGS
1177	323	BGS
1178	81	KM
1179	306	BGS
1182	305	BGS
1184	306	BGS
1184-6x7	QF13	BGS
1184-8x9	QF13	BGS
1184-10x11	QF13	BGS
1184-10X13	QF13	BGS
1184-12x13	QF13	BGS
1184-14x15	QF13	BGS
1184-16x17	QF13	BGS
1184-18x19	QF13	BGS
1184-20x22	QF13	BGS
1184-21x23	QF13	BGS
1184-24x27	QF13	BGS
1184-25x28	QF13	BGS
1184-30x32	QF13	BGS
1184-36x41	QF13	BGS
1184-LEER	306	BGS
1185	76	KM
1185-34	76	KM
1185-36	76	KM
1185-38	76	KM
1185-41	76	KM
1185-46	76	KM
1185-50	76	KM
1185-55	76	KM
1185-57	76	KM
1185-60	76	KM
1185-65	76	KM
1185-70	76	KM
1185-75	76	KM
1185-80	04_18	KM
1186-10x11	QF12	BGS
1186-12x14	QF12	BGS
1186-13x15	QF12	BGS

Art.		BGS/ KM
1186-16x18	QF12	BGS
1186-17x19	QF12	BGS
1186-21x23	QF12	BGS
1186-22x24	QF12	BGS
1187	311	BGS
1187-LEER	311	BGS
1188	300	BGS
1190	299	BGS
1192	297	BGS
1193	297	BGS
1194	298	BGS
1195	298	BGS
1196	299	BGS
1196-LEER	299	BGS
1197	298	BGS
1198	75	KM
1198-LEER	n/a	BGS
1199	301	BGS
1200	320	BGS
1201	321	BGS
1202	11	KM
1202-LEER	n/a	BGS
1204	206	BGS
1204-REPAIR	206	BGS
1204-LEER	n/a	BGS
1206	81	BGS
1206-LEER	n/a	BGS
1207	80	BGS
1207-60	QF1	BGS
1207-LEER	n/a	BGS
1209	307	BGS
1210	81	BGS
1210-LEER	n/a	BGS
1211	298	BGS
1212	307	BGS
1213	307	BGS
1214	308	BGS
1214-6x7	QF13	BGS
1214-8x9	QF13	BGS
1214-10x11	QF13	BGS
1214-12x13	QF13	BGS
1214-14x15	QF13	BGS
1214-16x17	QF13	BGS
1214-18x19	QF13	BGS
1214-20x22	QF13	BGS
1214-21x23	QF13	BGS
1214-24x27	QF13	BGS
1214-25x28	QF13	BGS
1214-30x32	QF13	BGS
1214-LEER	308	BGS
1215	309	BGS
1216	310	BGS
1217	309	BGS
1218	321	BGS
1219	301	BGS
1219-LEER	301	BGS
1222	309	BGS
1223	80	BGS
1225	136	KM
1226	250	BGS
1228	303	BGS

Art.		BGS/ KM
1228-6	QF11	BGS
1228-7	QF11	BGS
1228-8	QF11	BGS
1228-9	QF11	BGS
1228-10	QF11	BGS
1228-11	QF11	BGS
1228-12	QF11	BGS
1228-13	QF11	BGS
1228-14	QF11	BGS
1228-15	QF11	BGS
1228-16	QF11	BGS
1228-18	QF11	BGS
1228-17	QF11	BGS
1228-19	QF11	BGS
1228-LEER	303	BGS
1229	304	BGS
1229-21	QF11	BGS
1229-22	QF11	BGS
1229-24	QF11	BGS
1229-27	QF11	BGS
1229-30	QF11	BGS
1229-32	QF11	BGS
1229-LEER	304	BGS
1230	206	BGS
1230-1	206	BGS
1230-REPAIR	206	BGS
1230-LEER	n/a	BGS
1231	109	KM
1232	75	KM
1233	77	KM
1234	77	KM
1239	76	KM
1240	472	BGS
1257	754	BGS
1258	754	BGS
1300	128	BGS
1301	511	BGS
1310	731	BGS
1310-14	731	BGS
1311	732	BGS
1312	732	BGS
1314	732	BGS
1325	120	KM
1326	587	BGS
1327	586	BGS
1328	587	BGS
1330	588	BGS
1401	803	BGS
1402	785	BGS
1403	04_19	BGS
1408	810	BGS
1410	345	BGS
1410-A	345	BGS
1410-BNC	345	BGS
1410-B	345	BGS
1410-C	345	BGS
1410-C1	345	BGS
1410-D	345	BGS
1410-F	345	BGS
1410-G3	02_19	BGS
1410-H	345	BGS

Art.		BGS/ KM
1410-H1	345	BGS
1410-H6	02_18	BGS
1410-H7	02_18	BGS
1410-I2	345	BGS
1411	345	BGS
1412	346	BGS
1414	811	BGS
1415	811	BGS
1416	811	BGS
1417	346	BGS
1418	346	BGS
1419	346	BGS
1422	342	BGS
1423	87	KM
1426	346	BGS
1428	346	BGS
1429	347	BGS
1430	377	BGS
1435	840	BGS
1436	840	BGS
1437	840	BGS
1438	840	BGS
1439	840	BGS
1440	320	BGS
1441	320	BGS
1442	320	BGS
1443	320	BGS
1446	320	BGS
1448	81	KM
1449	80	KM
1450	81	KM
1450-LEER	n/a	BGS
1455	534	BGS
1456	534	BGS
1457	458	BGS
1458	457	BGS
1459	534	BGS
1461	273	BGS
1462	274	BGS
1463	250	BGS
1464	250	BGS
1464-4	250	BGS
1464-5	250	BGS
1469	276	BGS
1470	77	KM
1471	77	KM
1472	77	KM
1473	77	KM
1474	77	KM
1476	77	KM
1477	97	KM
1480	87	KM
1482	88	KM
1509	363	BGS
1510	114	KM
1513	458	BGS
1514	536	BGS
1514-M10	536	BGS
1514-M12	536	BGS
1514-M14	536	BGS
1514-M16	536	BGS

Art.		BGS/ KM
1514-LEER	536	BGS
1518	506	BGS
1519	531	BGS
1521	364	BGS
1522	554	BGS
1522-10	554	BGS
1523	531	BGS
1523-1	531	BGS
1523-LEER	531	BGS
1524	554	BGS
1527	841	BGS
1527-1	841	BGS
1528	436	BGS
1529	436	BGS
1530	841	BGS
1531	841	BGS
1532	841	BGS
1533	841	BGS
1534	841	BGS
1535	843	BGS
1536	844	BGS
1537	01_19	BGS
1538	844	BGS
1539	834	BGS
1540	841	BGS
1541	316	BGS
1541-LEER	316	BGS
1548	840	BGS
1550	844	BGS
1551	844	BGS
1555-LEER	n/a	BGS
1556	316	BGS
1558	318	BGS
1560	318	BGS
1561	318	BGS
1562	318	BGS
1564	318	BGS
1565	318	BGS
1567	318	BGS
1581	317	BGS
1582	317	BGS
1584	317	BGS
1585	317	BGS
1589	317	BGS
1591	317	BGS
1596	315	BGS
1600	237	BGS
1601	237	BGS
1604	49	KM
1605	371	BGS
1606	371	BGS
1607	237	BGS
1609	764	BGS
1610	n/a	BGS
1611	764	BGS
1613	763	BGS
1613-1	764	BGS
1615	330	BGS
1616	39	KM
1618	330	BGS
1619	330	BGS

Art.		BGS/ KM
1620	330	BGS
1621	330	BGS
1622	330	BGS
1624	328	BGS
1632	238	BGS
1634	120	KM
1636	121	KM
1638	562	BGS
1639	573	BGS
1640	257	BGS
1641	256	BGS
1642	573	BGS
1642-LEER	573	BGS
1646	258	BGS
1650	256	BGS
1651	259	BGS
1651-3	259	BGS
1651-4	259	BGS
1651-5	259	BGS
1651-6	259	BGS
1651-7	259	BGS
1651-8	259	BGS
1651-10	259	BGS
1651-12	259	BGS
1655	258	BGS
1656	255	BGS
1657	258	BGS
1658	254	BGS
1659	573	BGS
1659-KÖPFE	573	BGS
1659-LEER	573	BGS
1670	119	KM
1670-LEER	n/a	BGS
1672	561	BGS
1672-1	561	BGS
1672-2	561	BGS
1672-3	561	BGS
1672-4	561	BGS
1672-5	561	BGS
1672-6	561	BGS
1672-7	561	BGS
1674	119	KM
1674-LEER	n/a	BGS
1675	562	BGS
1676	561	BGS
1677	119	KM
1678	606	BGS
1680	261	BGS
1681	262	BGS
1682	715	BGS
1683	715	BGS
1684	715	BGS
1685	562	BGS
1686	07_18	BGS
1688	556	BGS
1688-1	556	BGS
1688-2	556	BGS
1688-4	556	BGS
1688-LEER	556	BGS
1689	556	BGS
1689-1	556	BGS

Art.		BGS/ KM
1689-2	556	BGS
1689-3	556	BGS
1689-LEER	556	BGS
1690	257	BGS
1691	257	BGS
1692	257	BGS
1693	257	BGS
1695	258	BGS
1696	255	BGS
1697	317	BGS
1698	257	BGS
1699	257	BGS
1702	317	BGS
1703	735	BGS
1705	733	BGS
1706	732	BGS
1707	733	BGS
1708	523	BGS
1709	523	BGS
1710	524	BGS
1712	524	BGS
1713	438	BGS
1714	733	BGS
1715	365	BGS
1716	365	BGS
1717	365	BGS
1718	366	BGS
1719	367	BGS
1721	367	BGS
1722	472	BGS
1723	173	BGS
1724	173	BGS
1727	172	BGS
1729	172	BGS
1730	172	BGS
1731	172	BGS
1732	173	BGS
1734	173	BGS
1735	173	BGS
1736	173	BGS
1737	741	BGS
1738	731	BGS
1738-1	731	BGS
1738-2	731	BGS
1738-20	04_19	BGS
1738-30	04_19	BGS
1738-35	04_19	BGS
1738-40	04_19	BGS
1739	742	BGS
1740	731	BGS
1741	731	BGS
1743	438	BGS
1744	726	BGS
1745	313	BGS
1745-8X9	312	BGS
1747	714	BGS
1749	109	KM
1749-1	109	KM
1749-2	109	KM
1749-3	109	KM
1749-4	109	KM

Art.		BGS/ KM
1749-LEER	n/a	BGS
1750	312	BGS
1751	312	BGS
1752	312	BGS
1753-7	474	BGS
1753-8	474	BGS
1753-9	474	BGS
1753-10	474	BGS
1753-11	474	BGS
1755	314	BGS
1756	295	BGS
1756-10	295	BGS
1756-11	295	BGS
1756-12	295	BGS
1756-13	295	BGS
1756-14	295	BGS
1756-15	295	BGS
1756-16	295	BGS
1756-17	295	BGS
1756-18	295	BGS
1756-19	295	BGS
1757	296	BGS
1757-20	296	BGS
1757-21	296	BGS
1757-22	296	BGS
1757-23	296	BGS
1757-24	296	BGS
1757-25	296	BGS
1757-26	296	BGS
1757-27	296	BGS
1757-28	296	BGS
1757-30	296	BGS
1757-32	296	BGS
1757-LEER	296	BGS
1759	296	BGS
1759-33	296	BGS
1759-36	296	BGS
1759-38	296	BGS
1759-41	296	BGS
1759-46	296	BGS
1759-50	296	BGS
1760	473	BGS
1761	313	BGS
1761-8x10	312	BGS
1761-9x11	312	BGS
1761-12x13	312	BGS
1761-14x15	312	BGS
1761-16x18	312	BGS
1761-17x19	312	BGS
1761-19x22	312	BGS
1761-24x27	312	BGS
1761-30x32	312	BGS
1762	727	BGS
1763	714	BGS
1764	661	BGS
1767	714	BGS
1768	447	BGS
1769	671	BGS
1770	671	BGS
1771	715	BGS
1772	715	BGS

Art.		BGS/ KM
1773	593	BGS
1773-3	593	BGS
1774	715	BGS
1775	671	BGS
1775-LEER	671	BGS
1777	727	BGS
1778	725	BGS
1779	667	BGS
1780	729	BGS
1781	727	BGS
1782	313	BGS
1783	131	KM
1784	742	BGS
1788	874	BGS
1789	185	KM
1790	513	BGS
1791	491	BGS
1792	486	BGS
1793	486	BGS
1793-1	485	BGS
1794	193	KM
1795	518	BGS
1795-1	518	BGS
1796	517	BGS
1797	517	BGS
1798	486	BGS
1798-1	486	BGS
1799	691	BGS
1799-Z	112	KM
1800	579	BGS
1801	579	BGS
1802	460	BGS
1803	518	BGS
1804	518	BGS
1805	520	BGS
1806	514	BGS
1807	518	BGS
1808	520	BGS
1809	520	BGS
1810	269	BGS
1811	269	BGS
1812	269	BGS
1813	514	BGS
1813-23	514	BGS
1813-28	514	BGS
1813-34	514	BGS
1815	365	BGS
1817	491	BGS
1818	490	BGS
1818-1	490	BGS
1819	269	BGS
1819-1	269	BGS
1820	122	KM
1822	122	KM
1823	366	BGS
1824	595	BGS
1824-1	595	BGS
1825	366	BGS
1826	366	BGS
1827	366	BGS
1828	366	BGS

Art.		BGS/ KM
1829	82	KM
1830	82	KM
1831	491	BGS
1832	491	BGS
1833	489	BGS
1834	116	KM
1834-LEER	n/a	BGS
1835	84	KM
1836	84	KM
1837	84	KM
1838	84	KM
1840	84	KM
1841	82	KM
1842	83	KM
1843	82	KM
1844	82	KM
1845	82	KM
1847	50	KM
1850	50	KM
1851	50	KM
1852	50	KM
1853	50	KM
1854	50	KM
1855	50	KM
1856	50	KM
1857	50	KM
1858	50	KM
1859	254	BGS
1859-30	12_18	BGS
1860	50	KM
1861	50	KM
1862	50	KM
1863	252	BGS
1864	120	KM
1865	253	BGS
1868	252	BGS
1869	120	KM
1871	890	BGS
1872	890	BGS
1873	728	BGS
1874	753	BGS
1876	252	BGS
1877	727	BGS
1878	726	BGS
1880	143	KM
1882	326	BGS
1883	327	BGS
1884	327	BGS
1885	327	BGS
1886	327	BGS
1887	753	BGS
1888	753	BGS
1889	753	BGS
1890	127	KM
1891	49	KM
1891-LEER	n/a	BGS
1892	276	BGS
1893	243	BGS
1893-1	249	BGS
1893-2	248	BGS
1893-LEER	243	BGS

Art.		BGS/ KM
1895	122	BGS
1896	122	BGS
1897	18	KM
1898	244	BGS
1899	244	BGS
1900	245	BGS
1900-1	249	BGS
1900-2	249	BGS
1900-3	248	BGS
1900-4	248	BGS
1900-M6X1.0-B	239	BGS
1900-M8X1.0-B	239	BGS
1900-M8X1.0-S	02_19	BGS
1900-M8X1.25-B	239	BGS
1900-M10X0.75-B	239	BGS
1900-M10X1.0-B	239	BGS
1900-M10X1.25-B	239	BGS
1900-M10X1.5-B	239	BGS
1900-M11X0.75-B	239	BGS
1900-M11X1.0-B	239	BGS
1900-M11X1.25-B	239	BGS
1900-M12X0.75-B	239	BGS
1900-M12X1.0-B	239	BGS
1900-M12X1.25-B	239	BGS
1900-M12X1.5-B	239	BGS
1900-M12X1.75-B	239	BGS
1900-M14X1.0-B	239	BGS
1900-M14X1.25-B	239	BGS
1900-M14X1.5-B	239	BGS
1900-M8X1.25-S	239	BGS
1900-M10X1.25-S	239	BGS
1900-M10X1.5-S	239	BGS
1900-M12X1.25-S	239	BGS
1900-M12X1.5-S	239	BGS
1900-M14X1.25-S	239	BGS
1900-M14X1.5-S	239	BGS
1900-M18X1.5-S	239	BGS
1900-LEER	245	BGS
1902	163	KM
1903	327	BGS
1905	162	KM
1906	163	KM
1907	92	KM
1908	92	KM
1909	92	KM
1910	163	KM
1911	45	KM
1912	163	KM
1914	92	KM
1915	92	KM
1916	849	BGS
1917	371	BGS
1919	849	BGS
1920	236	BGS
1921	236	BGS
1922	239	BGS
1923	239	BGS
1924	247	BGS
1925	246	BGS
1926	248	BGS
1926-LEER	248	BGS

Art.		BGS/ KM
1927	246	BGS
1929	239	BGS
1930	264	BGS
1930-1	265	BGS
1930-LEER	264	BGS
1931	268	BGS
1932	264	BGS
1933	264	BGS
1934	264	BGS
1934-LEER	264	BGS
1935	265	BGS
1935-LEER	265	BGS
1937	488	BGS
1937-LEER	488	BGS
1938	267	BGS
1938-1	268	BGS
1938-2	268	BGS
1939	492	BGS
1940	727	BGS
1941	836	BGS
1943	489	BGS
1944	226	BGS
1945	328	BGS
1945-1	330	BGS
1946	372	BGS
1950	241	BGS
1951	241	BGS
1952	240	BGS
1952-3	01_19	BGS
1953	240	BGS
1953-3	01_19	BGS
1954	240	BGS
1954-3	01_19	BGS
1955	240	BGS
1955-3	01_19	BGS
1956	240	BGS
1956-3	01_19	BGS
1957	240	BGS
1957-3	01_19	BGS
1958	240	BGS
1958-3	01_19	BGS
1958-1	240	BGS
1959	240	BGS
1959-1	240	BGS
1959-2	240	BGS
1959-3	240	BGS
1959-4	240	BGS
1959-5	240	BGS
1959-6	240	BGS
1959-7	240	BGS
1960	251	BGS
1961	251	BGS
1962	251	BGS
1963	251	BGS
1965	251	BGS
1966	329	BGS
1967	251	BGS
1968	252	BGS
1969	252	BGS
1970	730	BGS
1974	890	BGS

Art.		BGS/ KM
1975	889	BGS
1975-1	889	BGS
1977	891	BGS
1979	889	BGS
1980	249	BGS
1981	249	BGS
1982	249	BGS
1983	249	BGS
1984	250	BGS
1984-1	250	BGS
1987	248	BGS
1987-1	248	BGS
1988	241	BGS
1988-1	241	BGS
1989	114	KM
1990	591	BGS
1991	163	KM
1992	163	KM
1993	163	KM
1994	220	BGS
1995	220	BGS
1995-LEER	220	BGS
1996	39	KM
1997	329	BGS
1997-4	04_19	BGS
1997-5	04_19	BGS
1997-6	04_19	BGS
1998	329	BGS
2000	220	BGS
2001	17	BGS
2001-1	n/a	BGS
2001-2	72	BGS
2001-3	72	BGS
2001-9	71	BGS
2002	21	BGS
2002-1	21	BGS
2004	18	BGS
2005	35	KM
2005-LEER	n/a	BGS
2006	35	KM
2007	35	KM
2009	221	BGS
2010	39	KM
2012	36	KM
2013	223	BGS
2014	224	BGS
2016	36	KM
2017	40	KM
2018	40	KM
2019	219	BGS
2020	131	BGS
2021	222	BGS
2022	41	KM
2023	224	BGS
2026	142	BGS
2027	135	BGS
2028	130	BGS
2029	487	BGS
2030	235	BGS
2031	235	BGS
2032	235	BGS

Art.		BGS/ KM
2033	235	BGS
2034	235	BGS
2035	235	BGS
2037	15	KM
2038	136	BGS
2039	14	KM
2040	223	BGS
2040-1	223	BGS
2040-1.5	223	BGS
2040-2	223	BGS
2040-2.5	223	BGS
2040-3	223	BGS
2040-3.5	223	BGS
2040-4	223	BGS
2040-4.5	223	BGS
2040-5	223	BGS
2040-5.5	223	BGS
2040-6	223	BGS
2040-6.5	223	BGS
2040-7	223	BGS
2040-7.5	223	BGS
2040-8	223	BGS
2040-8.5	223	BGS
2040-9	223	BGS
2040-9.5	223	BGS
2040-10	223	BGS
2044	166	KM
2048	53	KM
2049	53	KM
2050	235	BGS
2052	56	KM
2053	267	BGS
2054	56	KM
2055	56	KM
2058	56	KM
2060	59	KM
2061	272	BGS
2064	271	BGS
2065	59	KM
2067	58	KM
2068	58	KM
2069	59	KM
2070	52	KM
2070-SPITZ	52	KM
2071	166	KM
2072	831	BGS
2073	272	BGS
2077	271	BGS
2079	271	BGS
2080	53	KM
2081	271	BGS
2082	58	KM
2083	272	BGS
2085	255	BGS
2085-1	255	BGS
2086	509	BGS
2086-H5	509	BGS
2086-H6	509	BGS
2086-T50	02_19	BGS
2087	509	BGS
2087-H6	02_19	BGS

Art.		BGS/ KM
2087-H7	02_19	BGS
2087-H8	02_19	BGS
2101	837	BGS
2104	146	KM
2105	146	KM
2120	196	BGS
2126	186	BGS
2135	913	BGS
2136	218	BGS
2140	10_18	BGS
2141	74	BGS
2142	10	KM
2143	75	BGS
2143-LEER	n/a	BGS
2144	75	BGS
2144-1	n/a	BGS
2145	73	BGS
2146	74	BGS
2146-LEER	n/a	BGS
2147	73	BGS
2147-LEER	n/a	BGS
2148	10_18	BGS
2150	135	BGS
2151	75	BGS
2152	143	BGS
2152-LEER	n/a	BGS
2159	57	KM
2160	57	KM
2161	159	BGS
2161-10	QF6	BGS
2161-12	QF6	BGS
2162	163	BGS
2163	154	BGS
2164	170	BGS
2164-T45	QF7	BGS
2164-T50	QF7	BGS
2165	170	BGS
2165-T45	QF7	BGS
2165-T50	QF7	BGS
2166	159	BGS
2169	433	BGS
2169-1	433	BGS
2169-1-32	433	BGS
2169-1-38	433	BGS
2169-1-45	433	BGS
2169-2	434	BGS
2169-2-32	434	BGS
2169-2-38	434	BGS
2169-2-45	434	BGS
2169-3	434	BGS
2169-4	433	BGS
2169-5	434	BGS
2169-6	433	BGS
2169-8	434	BGS
2169-9	434	BGS
2169-10	04_18	BGS
2171	895	BGS
2172	113	KM
2175	895	BGS
2178	824	BGS
2181	104	BGS

Art.		BGS/ KM
2181-1	04_18	BGS
2181-2	04_18	BGS
2181-3	04_18	BGS
2182	113	KM
2184	822	BGS
2185	823	BGS
2186	822	BGS
2186-1	822	BGS
2187	896	BGS
2188	500	BGS
2188-1	500	BGS
2189	810	BGS
2191	914	BGS
2192-1	824	BGS
2193	815	BGS
2194-1	824	BGS
2196-ROLLE	n/a	BGS
2197	815	BGS
2198	813	BGS
2199	15	KM
2202	825	BGS
2203	825	BGS
2204	13	KM
2204-LEER	13	KM
2205	183	BGS
2206	183	BGS
2207	183	BGS
2210	QF10	BGS
2211	QF10	BGS
2215	77	BGS
2216	79	BGS
2217	04_19	BGS
2218	77	BGS
2219	QF10	BGS
2220	QF10	BGS
2221	133	BGS
2222	136	BGS
2223	139	BGS
2224	79	BGS
2224-LEER	n/a	BGS
2225	10_18	BGS
2226	140	BGS
2227	78	BGS
2227-LEER	n/a	BGS
2229	76	BGS
2229-1	195	BGS
2229-LEER	n/a	BGS
2231	QF10	BGS
2232	QF10	BGS
2233	191	BGS
2235	191	BGS
2236	191	BGS
2237	193	BGS
2239	192	BGS
2240	193	BGS
2242	76	BGS
2243	90	BGS
2244	316	BGS
2244-10x12	317	BGS
2245	94	BGS
2246	139	BGS

Art.		BGS/ KM
2247	92	BGS
2248	10_18	BGS
2252-LEER	n/a	BGS
2253	191	BGS
2255	115	BGS
2256	788	BGS
2258	315	BGS
2259	82	BGS
2260	QF12	BGS
2261	QF12	BGS
2262	QF12	BGS
2263	QF12	BGS
2264	311	BGS
2265	QF12	BGS
2266	QF12	BGS
2267	141	BGS
2268	311	BGS
2269	133	BGS
2271-LEER	n/a	BGS
2272	186	BGS
2274	186	BGS
2275	592	BGS
2281	312	BGS
2281-6X8	QF12	BGS
2281-10X12	QF12	BGS
2281-14X18	QF12	BGS
2281-20X24	QF12	BGS
2282-LEER	01_19	BGS
2283	5	KM
2283-LEER	n/a	BGS
2286	96	BGS
2287	6	KM
2289	102	BGS
2290	86	BGS
2290-LEER	n/a	BGS
2292	88	BGS
2292-LEER	n/a	BGS
2294	100	BGS
2294-LEER	n/a	BGS
2296	7	KM
2296-LEER	n/a	BGS
2297-LEER	n/a	BGS
2298	98	BGS
2298-LEER	n/a	BGS
2299	103	BGS
2300	28	KM
2301	189	BGS
2304	183	BGS
2308	183	BGS
2315	186	BGS
2315-REPAIR	190	BGS
2316	196	BGS
2317	196	BGS
2318	196	BGS
2320	190	BGS
2321	190	BGS
2323	193	BGS
2325	287	BGS
2330	196	BGS
2335	QF10	BGS
2336	QF10	BGS

Art.		BGS/ KM
2338	QF10	BGS
2339	QF3	BGS
2343	QF3	BGS
2344	QF3	BGS
2345	QF3	BGS
2346	QF3	BGS
2347	QF3	BGS
2348	QF3	BGS
2349	QF3	BGS
2350	QF3	BGS
2351	QF3	BGS
2352	QF3	BGS
2353	QF3	BGS
2354	QF3	BGS
2355	171	BGS
2355-TS15	QF6	BGS
2355-TS20	QF6	BGS
2355-25	QF6	BGS
2355-TS27	QF6	BGS
2355-TS30	QF6	BGS
2355-TS40	QF6	BGS
2355-TS50	QF6	BGS
2356	QF7	BGS
2357	QF7	BGS
2358	QF7	BGS
2359	QF7	BGS
2360	QF7	BGS
2361	QF7	BGS
2362	QF7	BGS
2363	QF7	BGS
2364	QF7	BGS
2366	QF3	BGS
2367	QF3	BGS
2368	QF3	BGS
2369	QF3	BGS
2370	QF3	BGS
2371	QF3	BGS
2372	QF3	BGS
2373	QF3	BGS
2374	QF3	BGS
2375	QF3	BGS
2376	QF3	BGS
2377	QF3	BGS
2378	QF3	BGS
2379	QF3	BGS
2380	QF3	BGS
2381	QF3	BGS
2382	QF3	BGS
2384	QF3	BGS
2385	740	BGS
2386	740	BGS
2387	740	BGS
2390	738	BGS
2391	738	BGS
2392	738	BGS
2400	739	BGS
2401	740	BGS
2402	740	BGS
2403	740	BGS
2404	738	BGS
2405	738	BGS

Art.		BGS/ KM
2408	QF3	BGS
2409	QF3	BGS
2410	QF3	BGS
2411	QF3	BGS
2412	QF3	BGS
2413	QF3	BGS
2414	QF3	BGS
2415	QF3	BGS
2416	QF3	BGS
2417	QF3	BGS
2418	QF3	BGS
2419	QF3	BGS
2420	QF3	BGS
2421	QF3	BGS
2422	QF3	BGS
2424	QF3	BGS
2427	QF3	BGS
2428	QF3	BGS
2429	134	BGS
2430	QF3	BGS
2432	QF3	BGS
2433	134	BGS
2434	139	BGS
2434-LEER	n/a	BGS
2435	140	BGS
2436	QF9	BGS
2437	QF9	BGS
2438	QF9	BGS
2439	QF9	BGS
2440	QF9	BGS
2441	QF9	BGS
2442	QF9	BGS
2443	QF9	BGS
2444	QF9	BGS
2445	QF9	BGS
2446	737	BGS
2447	739	BGS
2448	740	BGS
2449	738	BGS
2450	114	BGS
2452	114	BGS
2453	114	BGS
2454	114	BGS
2455	114	BGS
2456	114	BGS
2457	114	BGS
2458	114	BGS
2459	114	BGS
2460	01_19	BGS
2461	739	BGS
2463	740	BGS
2464	739	BGS
2465	123	KM
2466	739	BGS
2468	740	BGS
2469	740	BGS
2470	739	BGS
2471	739	BGS
2472	739	BGS
2473	QF1	BGS
2474	QF1	BGS

Art.		BGS/ KM
2475	QF1	BGS
2476	QF1	BGS
2477	QF1	BGS
2478	QF1	BGS
2479	QF1	BGS
2480	QF1	BGS
2481	QF1	BGS
2482	QF1	BGS
2483	QF1	BGS
2484	QF1	BGS
2485	QF1	BGS
2486	QF1	BGS
2487	QF7	BGS
2488	QF7	BGS
2489	QF7	BGS
2490	QF7	BGS
2491	QF7	BGS
2492	QF7	BGS
2493	QF7	BGS
2494	QF7	BGS
2495	QF7	BGS
2496	QF7	BGS
2497	QF6	BGS
2498	QF6	BGS
2499	QF6	BGS
2500	QF6	BGS
2501	QF6	BGS
2502	QF6	BGS
2503	QF6	BGS
2504	QF7	BGS
2505	QF7	BGS
2506	QF6	BGS
2507	QF6	BGS
2533	128	BGS
2537	598	BGS
2531	128	BGS
2538	606	BGS
2539	606	BGS
2540	196	BGS
2541	QF7	BGS
2542	QF7	BGS
2543	QF7	BGS
2544	QF7	BGS
2545	QF7	BGS
2546	QF7	BGS
2547	QF7	BGS
2548	QF7	BGS
2549	QF7	BGS
2550	QF7	BGS
2551	QF7	BGS
2552	QF7	BGS
2553	QF7	BGS
2554	QF7	BGS
2556	QF7	BGS
2557	QF7	BGS
2560	129	BGS
2565	QF7	BGS
2565-75	QF7	BGS
2567	QF7	BGS
2568	QF7	BGS
2571	QF7	BGS

Art.		BGS/ KM
2572	QF7	BGS
2573	QF7	BGS
2574	QF7	BGS
2575	QF7	BGS
2576	QF6	BGS
2577	QF6	BGS
2578	QF6	BGS
2579	QF6	BGS
2580	QF6	BGS
2581	QF6	BGS
2582	QF6	BGS
2583	QF6	BGS
2584	QF6	BGS
2587	QF6	BGS
2588	QF7	BGS
2589	QF7	BGS
2590	QF7	BGS
2591	QF7	BGS
2592	QF7	BGS
2593	QF7	BGS
2594	QF7	BGS
2595	QF7	BGS
2596	QF7	BGS
2597	QF7	BGS
2599	QF7	BGS
2600	QF3	BGS
2601	QF3	BGS
2602	QF3	BGS
2603	QF3	BGS
2604	QF3	BGS
2605	QF3	BGS
2606	QF3	BGS
2607	QF3	BGS
2608	QF3	BGS
2609	QF3	BGS
2610	QF3	BGS
2611	QF3	BGS
2710	QF4	BGS
2711	QF4	BGS
2712	QF4	BGS
2713	QF4	BGS
2714	QF4	BGS
2715	QF4	BGS
2720	QF6	BGS
2721	QF6	BGS
2722	QF6	BGS
2723	QF6	BGS
2726	224	BGS
2726-3	224	BGS
2726-4	224	BGS
2727	QF6	BGS
2729	QF6	BGS
2730	QF6	BGS
2731	224	BGS
2740	QF6	BGS
2741	QF6	BGS
2742	QF6	BGS
2743	QF6	BGS
2744	QF6	BGS
2745	QF6	BGS
2746	QF6	BGS

Art.		BGS/ KM
2747	QF6	BGS
2748	QF6	BGS
2749	159	BGS
2755	134	BGS
2756	137	BGS
2757	135	BGS
2758	228	BGS
2759	227	BGS
2760	QF7	BGS
2761	QF7	BGS
2762	227	BGS
2763	227	BGS
2764	227	BGS
2765	227	BGS
2766	227	BGS
2767	227	BGS
2768	227	BGS
2769	227	BGS
2770	QF1	BGS
2771	QF1	BGS
2772	QF1	BGS
2773	QF1	BGS
2774	QF1	BGS
2775	QF1	BGS
2776	QF1	BGS
2777	QF1	BGS
2778	QF1	BGS
2779	QF1	BGS
2784	04_18	BGS
2786	04_18	BGS
2787	04_18	BGS
2788	04_18	BGS
2790	581	BGS
2798	205	BGS
2798-REPAIR	208	BGS
2799-REPAIR	208	BGS
2800-REPAIR	208	BGS
2801-REPAIR	208	BGS
2803	204	BGS
2803-REPAIR	208	BGS
2804	204	BGS
2804-REPAIR	208	BGS
2805	204	BGS
2805-REPAIR	208	BGS
2806	204	BGS
2806-REPAIR	208	BGS
2807	204	BGS
2807-REPAIR	208	BGS
2808	204	BGS
2808-REPAIR	208	BGS
2813	12_18	BGS
2830	n/a	BGS
2832	849	BGS
2850	847	BGS
2883	891	BGS
2884	894	BGS
2885	892	BGS
2888	891	BGS
2889	892	BGS
2889-1	892	BGS
2889-2	892	BGS

Art.		BGS/ KM
2894	225	BGS
2897	892	BGS
2900	559	BGS
2901	559	BGS
2902	559	BGS
2903	560	BGS
2904	560	BGS
2905	560	BGS
2906	560	BGS
2907	561	BGS
2908	QF1	BGS
2909	QF1	BGS
2910	QF1	BGS
2911	QF1	BGS
2912	QF1	BGS
2913	QF1	BGS
2914	QF1	BGS
2915	QF1	BGS
2916	QF1	BGS
2917	QF1	BGS
2918	QF1	BGS
2919	QF1	BGS
2920	QF1	BGS
2921	QF1	BGS
2922	QF1	BGS
2924	QF1	BGS
2926	QF1	BGS
2927	QF1	BGS
2928	QF1	BGS
2930	QF1	BGS
2932	QF1	BGS
2934	QF1	BGS
2935	QF1	BGS
2936	QF1	BGS
2943	QF3	BGS
2944	QF3	BGS
2945	QF3	BGS
2946	QF3	BGS
2947	QF3	BGS
2948	QF3	BGS
2949	QF3	BGS
2951	QF3	BGS
2952	QF3	BGS
2956	QF3	BGS
2964	QF3	BGS
2965	QF3	BGS
2966	QF3	BGS
2967	QF3	BGS
2968	QF3	BGS
2969	QF3	BGS
2970	QF3	BGS
2971	QF3	BGS
2972	QF3	BGS
2973	QF3	BGS
2974	QF3	BGS
2980	746	BGS
2981	746	BGS
2982	746	BGS
2983	746	BGS
2984	746	BGS
2984-1	738	BGS

Art.		BGS/ KM
2985	746	BGS
2986	745	BGS
2987	738	BGS
2989	849	BGS
2990	746	BGS
2992	848	BGS
2994	849	BGS
2995	848	BGS
2996	848	BGS
2996-1	848	BGS
2997	848	BGS
2999	888	BGS
3001	888	BGS
3002	143	KM
3004	775	BGS
3005	166	KM
3006	167	KM
3007	775	BGS
3008	775	BGS
3009	775	BGS
3010	914	BGS
3010-1	914	BGS
3011	167	KM
3011-1	69	BGS
3011-2	69	BGS
3011-3	69	BGS
3012	167	KM
3014	890	BGS
3014-9	890	BGS
3015	890	BGS
3015-9	890	BGS
3016	890	BGS
3016-9	890	BGS
3018	188	KM
3020	167	KM
3021	167	KM
3022	167	KM
3023	167	KM
3024	187	KM
3025	873	BGS
3026	188	KM
3027	586	BGS
3028	235	BGS
3029	588	BGS
3030	501	BGS
3031	235	BGS
3032	588	BGS
3033	235	BGS
3034	235	BGS
3035	235	BGS
3036	235	BGS
3038	235	BGS
3039	235	BGS
3040	235	BGS
3041	622	BGS
3043	45	KM
3044	325	BGS
3045	325	BGS
3046	325	BGS
3048	162	KM
3050	895	BGS

Art.		BGS/ KM
3051	555	BGS
3051-LEER	555	BGS
3056	85	KM
3057	465	BGS
3057-13	465	BGS
3057-14	465	BGS
3057-15	465	BGS
3057-16	465	BGS
3057-17	465	BGS
3057-18	465	BGS
3057-19	465	BGS
3057-20	465	BGS
3057-21	465	BGS
3057-22	465	BGS
3057-23	465	BGS
3057-24	465	BGS
3057-25	465	BGS
3057-26	465	BGS
3058	04_18	BGS
3060	112	KM
3061	467	BGS
3062	466	BGS
3063	278	BGS
3064	754	BGS
3065	765	BGS
3065-1	765	BGS
3066	766	BGS
3067	250	BGS
3068	250	BGS
3069	250	BGS
3070	207	BGS
3073	231	BGS
3074	915	BGS
3076	232	BGS
3077	232	BGS
3078	229	BGS
3078-1	01_19	BGS
3078-2	01_19	BGS
3078-3	01_19	BGS
3078-8-S	01_19	BGS
3078-9-S	01_19	BGS
3078-10-S	01_19	BGS
3078-11-S	01_19	BGS
3078-12-S	01_19	BGS
3078-13-S	01_19	BGS
3078-14-S	01_19	BGS
3078-15-S	01_19	BGS
3078-16-S	01_19	BGS
3078-17-S	01_19	BGS
3078-18-S	01_19	BGS
3078-19-S	01_19	BGS
3078-8-M	01_19	BGS
3078-9-M	01_19	BGS
3078-10-M	01_19	BGS
3078-11-M	01_19	BGS
3078-12-M	01_19	BGS
3078-13-M	01_19	BGS
3078-14-M	01_19	BGS
3078-15-M	01_19	BGS
3078-16-M	01_19	BGS
3078-17-M	01_19	BGS

Art.		BGS/ KM
3078-18-M	01_19	BGS
3078-19-M	01_19	BGS
3078-8-N	01_19	BGS
3078-9-N	01_19	BGS
3078-10-N	01_19	BGS
3078-11-N	01_19	BGS
3078-12-N	01_19	BGS
3078-13-N	01_19	BGS
3078-14-N	01_19	BGS
3078-15-N	01_19	BGS
3078-16-N	01_19	BGS
3078-17-N	01_19	BGS
3078-18-N	01_19	BGS
3078-19-N	01_19	BGS
3079	44	KM
3080	231	BGS
3081	776	BGS
3082	729	BGS
3083	729	BGS
3084	207	BGS
3085	278	BGS
3086	139	KM
3087	139	KM
3088	774	BGS
3089	773	BGS
3090	140	KM
3091	774	BGS
3092	589	BGS
3093	140	KM
3094	772	BGS
3095	775	BGS
3096	178	KM
3098	178	KM
3099	178	KM
3100	178	KM
3101	178	KM
3102	772	BGS
3103	178	KM
3104	589	BGS
3105	04_18	KM
3109	04_19	BGS
3120	QF10	BGS
3121	QF10	BGS
3125	193	BGS
3130	405	BGS
3131	255	BGS
3132	QF10	BGS
3134	QF10	BGS
3135	729	BGS
3140	765	BGS
3141	765	BGS
3142	766	BGS
3143	766	BGS
3144	138	KM
3145-1	n/a	BGS
3145-3	n/a	BGS
3150	512	BGS
3154	773	BGS
3155	467	BGS
3156	754	BGS
3157	468	BGS

Art.		BGS/ KM
3158	773	BGS
3159	773	BGS
3160	466	BGS
3161	466	BGS
3162	466	BGS
3163	466	BGS
3164	466	BGS
3165	466	BGS
3166	466	BGS
3169	208	BGS
3170	208	BGS
3171	231	BGS
3172	231	BGS
3173	231	BGS
3174	774	BGS
3175	10_18	BGS
3175-1	10_18	BGS
3175-2	10_18	BGS
3175-3	10_18	BGS
3176	776	BGS
3177	281	BGS
3178	281	BGS
3180	281	BGS
3183	774	BGS
3184	729	BGS
3187	774	BGS
3188	775	BGS
3192	589	BGS
3193	589	BGS
3197	772	BGS
3200	227	BGS
3201	402	BGS
3202	401	BGS
3203	412	BGS
3204	412	BGS
3205	398	BGS
3205-1	398	BGS
3205-2	398	BGS
3206	411	BGS
3206-1	02_18	BGS
3206-2	02_18	BGS
3206-3	02_18	BGS
3207	401	BGS
3208	401	BGS
3209	389	BGS
3210	399	BGS
3211	100	KM
3212	399	BGS
3213	102	KM
3213-1	102	KM
3214	403	BGS
3215	399	BGS
3216	563	BGS
3217	563	BGS
3217-1	563	BGS
3217-2	563	BGS
3217-3	563	BGS
3218	415	BGS
3219	416	BGS
3220	412	BGS
3221	188	KM

Art.		BGS/ KM
3222	424	BGS
3222-1	424	BGS
3222-2	425	BGS
3222-3	425	BGS
3222-4	425	BGS
3223	390	BGS
3223-LEER	390	BGS
3224	394	BGS
3225	392	BGS
3226	425	BGS
3226-1	425	BGS
3227	424	BGS
3228	424	BGS
3229	394	BGS
3230	898	BGS
3231	913	BGS
3232	851	BGS
3233	387	BGS
3234	393	BGS
3235	391	BGS
3236	418	BGS
3236-1	418	BGS
3237	397	BGS
3237-2	397	BGS
3238	386	BGS
3239	393	BGS
3240	392	BGS
3241	423	BGS
3242	402	BGS
3242-1	403	BGS
3243	415	BGS
3243-TASCHE	415	BGS
3243-1	415	BGS
3244	414	BGS
3244-1	414	BGS
3245	388	BGS
3245-1	389	BGS
3246	389	BGS
3246-7	389	BGS
3247	387	BGS
3249	406	BGS
3250	405	BGS
3253	404	BGS
3255	397	BGS
3256	416	BGS
3257	416	BGS
3258	416	BGS
3259	388	BGS
3260-1	397	BGS
3262	395	BGS
3263	422	BGS
3264	407	BGS
3265	406	BGS
3266	409	BGS
3267	417	BGS
3268	408	BGS
3269	407	BGS
3269-1	02_19	BGS
3270	413	BGS
3271	407	BGS
3272	844	BGS

Art.		BGS/ KM
3274-1-1	n/a	BGS
3274-1-2	n/a	BGS
3274-1-3	n/a	BGS
3274-2	n/a	BGS
3274-3	n/a	BGS
3276	410	BGS
3276-1	410	BGS
3277	401	BGS
3277-REP01	401	BGS
3278	399	BGS
3279	100	KM
3280	388	BGS
3282	394	BGS
3284	417	BGS
3285	404	BGS
3286	408	BGS
3286-1	408	BGS
3287	408	BGS
3288	101	KM
3290	409	BGS
3290-1	409	BGS
3291	409	BGS
3291-30	409	BGS
3291-50	409	BGS
3291-70	409	BGS
3292	07_18	BGS
3294	103	KM
3295	391	BGS
3297	404	BGS
3300	331	BGS
3301	331	BGS
3302	331	BGS
3304	331	BGS
3306	108	BGS
3307	331	BGS
3312	20	BGS
3314	332	BGS
3315	411	BGS
3315-1	02_18	BGS
3315-2	02_18	BGS
3317	411	BGS
3317-1	02_18	BGS
3317-2	02_18	BGS
3317-3	02_18	BGS
3318	110	BGS
3319	04_18	BGS
3320	386	BGS
3321	431	BGS
3321-1	431	BGS
3322	109	BGS
3323	02_19	BGS
3341	111	BGS
3341-1	111	BGS
3342	112	BGS
3342-1	112	BGS
3343	113	BGS
3343-1	113	BGS
3344	112	BGS
3344-1	112	BGS
3400	397	BGS
3401	813	BGS

Art.		BGS/ KM
3419	QF1	BGS
3421	QF1	BGS
3422	QF1	BGS
3423	QF1	BGS
3426	QF1	BGS
3424	QF1	BGS
3427	QF1	BGS
3430	QF1	BGS
3432	QF1	BGS
3433	QF1	BGS
3434	QF1	BGS
3435	QF1	BGS
3436	QF1	BGS
3438	QF1	BGS
3441	QF1	BGS
3442	QF1	BGS
3444	QF1	BGS
3446	QF1	BGS
3448	QF1	BGS
3450	QF1	BGS
3455	QF1	BGS
3460	196	BGS
3480	897	BGS
3482	897	BGS
3483	896	BGS
3484	896	BGS
3485	896	BGS
3494	149	KM
3495	148	KM
3507	138	KM
3510	765	BGS
3511	764	BGS
3512	765	BGS
3513	764	BGS
3514	418	BGS
3515	418	BGS
3515-1	420	BGS
3516	901	BGS
3516-1	901	BGS
3516-2	901	BGS
3517	902	BGS
3518	902	BGS
3521	507	BGS
3525	557	BGS
3530	831	BGS
3530-1	831	BGS
3530-LEER	02_19	BGS
3531	831	BGS
3532	832	BGS
3535	832	BGS
3538	578	BGS
3539	578	BGS
3541	121	KM
3542	579	BGS
3543	579	BGS
3544	580	BGS
3545	588	BGS
3546	579	BGS
3547	580	BGS
3548	578	BGS
3550	147	KM

Art.		BGS/ KM
3553	148	KM
3554	148	KM
3559	190	BGS
3597	147	KM
3574	266	BGS
3598	147	KM
3599	147	KM
3600	147	KM
3620	904	BGS
3622	902	BGS
3623	904	BGS
3624	151	KM
3625	904	BGS
3627	902	BGS
3628	903	BGS
3630	903	BGS
3631	903	BGS
3640	903	BGS
3641	903	BGS
3650	102	KM
3650-1	04_19	KM
3736	QF1	BGS
3741	QF1	BGS
3746	QF1	BGS
3750	QF1	BGS
3755	QF1	BGS
3760	QF1	BGS
3765	QF1	BGS
3770	QF1	BGS
3775	QF1	BGS
3780	QF1	BGS
3800	218	BGS
3830	218	BGS
3834	218	BGS
3835	51	KM
3846	251	BGS
3847	251	BGS
3848	251	BGS
3849	251	BGS
3850	253	BGS
3852	253	BGS
3854	253	BGS
3855	253	BGS
3856	253	BGS
3857	253	BGS
3858	253	BGS
3860	254	BGS
3865	251	BGS
3870	561	BGS
3871	561	BGS
3872	561	BGS
3873	561	BGS
3902	276	BGS
3903	41	KM
3904	41	KM
3906	219	BGS
3906-1	219	BGS
3910	219	BGS
3911	219	BGS
3913	219	BGS
3914	219	BGS

Art.		BGS/ KM
3915	219	BGS
3916	219	BGS
3917	219	BGS
3921	85	KM
3922	282	BGS
3927	282	BGS
3931	86	KM
3932	86	KM
3934	86	KM
3935	282	BGS
3936	282	BGS
3937	282	BGS
3941	86	KM
3944	86	KM
3950	61	KM
3952	61	KM
3953	61	KM
3954	61	KM
3955	61	KM
3956	61	KM
3957	61	KM
3958	61	KM
3965	279	BGS
3970	279	BGS
3971	279	BGS
3972	279	BGS
3973	279	BGS
3974	279	BGS
3975	279	BGS
3976	279	BGS
3977	279	BGS
3978	280	BGS
3980	233	BGS
3981	232	BGS
3982	232	BGS
3983	233	BGS
3985	232	BGS
3986	232	BGS
3987	233	BGS
3988	233	BGS
3989	279	BGS
3990	279	BGS
3991	279	BGS
3993	233	BGS
3994	233	BGS
3995	278	BGS
3999	281	BGS
3999-1	02_19	BGS
4001	20	BGS
4010	58	BGS
4010-1	339	BGS
4010-2	339	BGS
4010-3	339	BGS
4010-4	339	BGS
4010-5	339	BGS
4010-6	339	BGS
4010-7	339	BGS
4010-8	339	BGS
4010-9	339	BGS
4010-10	340	BGS
4010-11	340	BGS

Art.		BGS/ KM
4010-12	340	BGS
4010-13	340	BGS
4010-14	340	BGS
4010-15	340	BGS
4010-16	340	BGS
4010-17	340	BGS
4010-18	340	BGS
4010-20	58	BGS
4011	58	BGS
4011-5	58	BGS
4012	54	BGS
4012-5	54	BGS
4013	57	BGS
4013-5	57	BGS
4014	57	BGS
4014-5	57	BGS
4015	51	BGS
4015-5	51	BGS
4016	55	BGS
4016-5	55	BGS
4017	53	BGS
4017-5	53	BGS
4019	429	BGS
4020	56	BGS
4020-5	56	BGS
4022	36	BGS
4022-1	36	BGS
4024	35	BGS
4024-1	35	BGS
4025	36	BGS
4025-1	36	BGS
4026	38	BGS
4026-1	38	BGS
4027	38	BGS
4027-1	38	BGS
4028	40	BGS
4028-1	40	BGS
4029	39	BGS
4029-1	39	BGS
4030	39	BGS
4030-1	39	BGS
4031	42	BGS
4031-1	42	BGS
4032	44	BGS
4032-1	44	BGS
4033	60	BGS
4033-1	60	BGS
4034	59	BGS
4034-1	59	BGS
4035	10_18	BGS
4035-1	10_18	BGS
4036	52	BGS
4036-1	52	BGS
4037	34	BGS
4037-1	34	BGS
4038	54	BGS
4038-1	54	BGS
4040	37	BGS
4040-1	37	BGS
4041	45	BGS
4041-1	45	BGS

Art.		BGS/ KM
4042	36	BGS
4042-1	36	BGS
4043	46	BGS
4043-1	46	BGS
4045	50	BGS
4045-1	50	BGS
4046	43	BGS
4046-1	43	BGS
4048	41	BGS
4048-1	41	BGS
4049	42	BGS
4049-1	42	BGS
4050	7	BGS
4051	30	BGS
4051-1	30	BGS
4052	25	BGS
4052-1	25	BGS
4053	47	BGS
4053-1	47	BGS
4054	24	BGS
4054-1	24	BGS
4055	48	BGS
4055-1	48	BGS
4056	26	BGS
4056-1	26	BGS
4057	28	BGS
4057-1	28	BGS
4058	27	BGS
4058-1	27	BGS
4059	26	BGS
4059-1	26	BGS
4060	9	BGS
4061	10	BGS
4062	11	BGS
4063	756	BGS
4064	755	BGS
4065	807	BGS
4066	755	BGS
4067	754	BGS
4067-1	754	BGS
4068	754	BGS
4068-1	754	BGS
4070-2	2	KM
4074	02_18	KM
4074-1	04_18	KM
4076	33	BGS
4076-1	33	BGS
4077	47	BGS
4077-1	47	BGS
4078	33	BGS
4078-1	33	BGS
4079	48	BGS
4079-1	48	BGS
4080	12	BGS
4081	31	BGS
4081-1	31	BGS
4082	31	BGS
4082-1	31	BGS
4083	31	BGS
4083-1	31	BGS
4084	32	BGS

Art.		BGS/ KM
4084-1	32	BGS
4086	13	BGS
4087	15	BGS
4088	4	BGS
4089	55	BGS
4089-1	55	BGS
4090	8	BGS
4091	46	BGS
4092	30	BGS
4092-1	30	BGS
4093	29	BGS
4093-1	29	BGS
4094	41	BGS
4094-1	41	BGS
4095	142	BGS
4095-2	920	BGS
4096	45	BGS
4096-1	45	BGS
4097	29	BGS
4097-1	29	BGS
4098	27	BGS
4098-1	27	BGS
4099	27	BGS
4099-1	27	BGS
4100	16	BGS
4100-1	n/a	BGS
4100-3	72	BGS
4100-4	72	BGS
4100-9	71	BGS
4101	22	BGS
4102	16	BGS
4103	04_19	BGS
4104	02_19	BGS
4105	18	BGS
4110	17	BGS
4110-2	72	BGS
4110-3	72	BGS
4110-9	71	BGS
4111	15	BGS
4111-2	72	BGS
4111-3	72	BGS
4111-9	71	BGS
4112	19	BGS
4113	6	BGS
4114	5	BGS
4115	14	BGS
4116	02_18	BGS
4116-1	02_18	BGS
4117	02_18	BGS
4117-1	02_18	BGS
4118	02_18	BGS
4118-1	02_18	BGS
4119	02_18	BGS
4119-1	02_18	BGS
4120	02_18	BGS
4120-1	02_18	BGS
4121	26	BGS
4121-1	26	BGS
4122	49	BGS
4122-1	49	BGS
4123	40	BGS

Art.		BGS/KM
4123-1	40	BGS
4124	44	BGS
4124-1	44	BGS
4125	37	BGS
4125-1	37	BGS
4126	25	BGS
4126-1	25	BGS
4127	24	BGS
4127-1	24	BGS
4128	32	BGS
4128-1	32	BGS
4129	43	BGS
4129-1	43	BGS
4130	28	BGS
4130-1	28	BGS
4131	34	BGS
4131-1	34	BGS
4132	35	BGS
4132-1	35	BGS
4133	49	BGS
4133-1	49	BGS
4134	60	BGS
4135	61	BGS
4136	62	BGS
4137	63	BGS
4138	64	BGS
4139	65	BGS
4140	14	BGS
4141	QF7	BGS
4142	QF7	BGS
4143	QF7	BGS
4145	QF7	BGS
4150	QF7	BGS
4151	QF7	BGS
4152	QF7	BGS
4153	QF7	BGS
4154	QF7	BGS
4155	QF7	BGS
4156	QF7	BGS
4157	QF7	BGS
4158	QF7	BGS
4159	10_18	BGS
4160	QF7	BGS
4161	QF7	BGS
4162	QF7	BGS
4163	QF7	BGS
4165	QF7	BGS
4166	QF7	BGS
4167	QF7	BGS
4168	QF7	BGS
4173	QF7	BGS
4174	QF7	BGS
4176	QF7	BGS
4177	QF7	BGS
4178	QF7	BGS
4179	QF7	BGS
4183	QF7	BGS
4184	QF7	BGS
4185	QF7	BGS
4186	QF7	BGS
4187	QF7	BGS

Art.		BGS/KM
4188	QF7	BGS
4189	QF7	BGS
4190	12_18	BGS
4194	02_19	BGS
4194-1	02_19	BGS
4200	19	BGS
4202	QF7	BGS
4203	QF7	BGS
4215	QF6	BGS
4216	QF6	BGS
4217	QF6	BGS
4218	QF6	BGS
4224	162	BGS
4227	QF6	BGS
4228	QF6	BGS
4229	QF6	BGS
4233	QF6	BGS
4234	QF7	BGS
4240	626	BGS
4245	627	BGS
4246	626	BGS
4246-T40	171	BGS
4246-T50	171	BGS
4246-M10	171	BGS
4246-LEER	626	BGS
4247	625	BGS
4248	624	BGS
4248-2	624	BGS
4248-3	624	BGS
4248-4	624	BGS
4249	626	BGS
4250	QF6	BGS
4251	QF6	BGS
4252	QF6	BGS
4253	QF6	BGS
4254	QF6	BGS
4255	QF6	BGS
4256	QF6	BGS
4257	QF6	BGS
4258	157	BGS
4258-5	QF6	BGS
4258-6	QF6	BGS
4258-7	QF6	BGS
4258-8	QF6	BGS
4258-10	QF6	BGS
4258-12	QF6	BGS
4259	QF6	BGS
4260	QF6	BGS
4261	QF6	BGS
4262	QF6	BGS
4263	QF6	BGS
4264	QF6	BGS
4265	QF6	BGS
4266	QF6	BGS
4267	04_18	BGS
4268	QF6	BGS
4270	QF6	BGS
4271	QF6	BGS
4272	QF6	BGS
4273	QF6	BGS
4274	QF6	BGS

Art.		BGS/KM
4275	QF6	BGS
4276	QF6	BGS
4277	QF6	BGS
4278	QF6	BGS
4279	QF6	BGS
4280	QF6	BGS
4286	QF8	BGS
4295	QF6	BGS
4296	QF6	BGS
4326	QF7	BGS
4327	QF7	BGS
4328	QF7	BGS
4329	QF7	BGS
4330	QF6	BGS
4331	QF6	BGS
4332	QF6	BGS
4333	QF6	BGS
4334	QF6	BGS
4335	QF6	BGS
4336	QF6	BGS
4337	QF6	BGS
4340	QF6	BGS
4344	QF6	BGS
4346	QF6	BGS
4347	QF6	BGS
4349	QF6	BGS
4350	QF6	BGS
4351	QF6	BGS
4352	QF6	BGS
4353	QF6	BGS
4354	QF6	BGS
4355	QF6	BGS
4356	QF6	BGS
4357	QF6	BGS
4358	QF8	BGS
4359	QF6	BGS
4360	QF6	BGS
4361	QF6	BGS
4362	QF6	BGS
4363	QF6	BGS
4364	QF6	BGS
4365	QF6	BGS
4367	QF7	BGS
4368	QF7	BGS
4369	QF7	BGS
4370	QF7	BGS
4371	QF7	BGS
4372	QF7	BGS
4373	QF7	BGS
4374	QF7	BGS
4375	QF7	BGS
4376	QF7	BGS
4377	QF7	BGS
4378	QF7	BGS
4379	QF7	BGS
4380	QF9	BGS
4381	QF9	BGS
4382	QF9	BGS
4383	QF9	BGS
4384	QF9	BGS
4385	QF9	BGS

Art.		BGS/KM
4386	QF9	BGS
4387	QF9	BGS
4388	QF9	BGS
4389	QF9	BGS
4390	QF9	BGS
4391	QF9	BGS
4410	QF9	BGS
4415	QF9	BGS
4420	QF9	BGS
4425	QF9	BGS
4427	QF9	BGS
4430	QF9	BGS
4432	QF6	BGS
4440	QF9	BGS
4445	QF9	BGS
4450	QF9	BGS
4455	QF9	BGS
4456	QF9	BGS
4457	QF9	BGS
4458	QF9	BGS
4460	QF9	BGS
4462	QF8	BGS
4463	QF8	BGS
4467	QF7	BGS
4468	QF7	BGS
4469	QF7	BGS
4470	QF7	BGS
4471	QF7	BGS
4472	QF7	BGS
4473	QF7	BGS
4474	QF7	BGS
4475	QF7	BGS
4476	QF7	BGS
4477	QF7	BGS
4478	602	BGS
4479	QF7	BGS
4480	QF7	BGS
4481	QF7	BGS
4482	QF7	BGS
4483	QF7	BGS
4484	QF7	BGS
4485	QF7	BGS
4490	349	BGS
4491	349	BGS
4494	349	BGS
4495	347	BGS
4496	351	BGS
4497	351	BGS
4498	351	BGS
4499	348	BGS
4500	351	BGS
4566	QF9	BGS
4567	QF9	BGS
4568	QF9	BGS
4569	QF9	BGS
4570	QF9	BGS
4571	QF9	BGS
4572	QF9	BGS
4573	QF9	BGS
4574	QF9	BGS
4575	QF9	BGS

Art.		BGS/ KM
4576	QF9	BGS
4581	QF9	BGS
4590	QF9	BGS
4591	QF9	BGS
4592	QF9	BGS
4593	QF9	BGS
4595	QF9	BGS
4596	04_18	BGS
4597	04_18	BGS
4598	04_18	BGS
4599	04_18	BGS
4600	04_18	BGS
4601	04_18	BGS
4602	04_18	BGS
4610	QF9	BGS
4615	QF9	BGS
4620	QF9	BGS
4625	QF9	BGS
4627	QF9	BGS
4630	QF9	BGS
4640	QF9	BGS
4645	QF9	BGS
4650	QF9	BGS
4655	QF9	BGS
4660	QF9	BGS
4670	QF9	BGS
4710	QF9	BGS
4727	QF9	BGS
4735	QF9	BGS
4736	QF9	BGS
4760	QF9	BGS
4761	QF9	BGS
4762	QF9	BGS
4763	QF9	BGS
4764	QF9	BGS
4765	QF9	BGS
4766	QF9	BGS
4767	QF9	BGS
4768	QF9	BGS
4770	QF9	BGS
4771	QF9	BGS
4772	QF9	BGS
4773	QF9	BGS
4774	QF9	BGS
4775	QF9	BGS
4776	QF9	BGS
4777	QF9	BGS
4778	QF9	BGS
4779	QF9	BGS
4780	QF9	BGS
4800	851	BGS
4801	851	BGS
4802	456	BGS
4803	839	BGS
4804	850	BGS
4805	850	BGS
4810	01_19	BGS
4811	01_19	BGS
4813	24	KM
4814	24	KM
4815	180	BGS

Art.		BGS/ KM
4815-1	n/a	BGS
4816	180	BGS
4830	24	KM
4838	294	BGS
4842	622	BGS
4845	27	KM
4846	27	KM
4847	229	BGS
4850	QF9	BGS
4851	QF9	BGS
4852	QF9	BGS
4853	QF9	BGS
4854	QF9	BGS
4859	QF9	BGS
4860	QF9	BGS
4861	QF9	BGS
4862	QF9	BGS
4863	QF9	BGS
4864	QF9	BGS
4866	QF9	BGS
4867	QF9	BGS
4868	QF9	BGS
4869	QF9	BGS
4870	QF9	BGS
4871	QF9	BGS
4872	QF9	BGS
4873	QF9	BGS
4874	QF9	BGS
4875	QF9	BGS
4876	QF9	BGS
4901	291	BGS
4902	291	BGS
4903	291	BGS
4904	291	BGS
4905	291	BGS
4906	291	BGS
4907	289	BGS
4908	289	BGS
4909	289	BGS
4910	289	BGS
4911	289	BGS
4912	289	BGS
4913	292	BGS
4914	292	BGS
4915	292	BGS
4916	292	BGS
4917	292	BGS
4918	292	BGS
4919	292	BGS
4920	292	BGS
4921	292	BGS
4922	292	BGS
4923	292	BGS
4924	292	BGS
4925	292	BGS
4926	289	BGS
4927	289	BGS
4928	291	BGS
4929	291	BGS
4930	291	BGS
4931	291	BGS

Art.		BGS/ KM
4932	290	BGS
4933	290	BGS
4934	290	BGS
4935	289	BGS
4936	289	BGS
4937	289	BGS
4940	292	BGS
4941	292	BGS
4942	289	BGS
4943	287	BGS
4944	293	BGS
4945	293	BGS
4946	293	BGS
4947	293	BGS
4950	QF9	BGS
4951	QF9	BGS
4952	QF9	BGS
4953	QF9	BGS
4954	QF9	BGS
4955	QF9	BGS
4956	QF9	BGS
4957	QF9	BGS
4959	QF9	BGS
4960	QF9	BGS
4961	QF9	BGS
4962	QF9	BGS
4963	QF9	BGS
4964	QF9	BGS
4965	QF9	BGS
4966	QF9	BGS
4993	181	BGS
4995	485	BGS
4996	485	BGS
4997	485	BGS
5003	QF3	BGS
5006	177	BGS
5007	QF7	BGS
5009	QF6	BGS
5010	QF7	BGS
5013	176	BGS
5013-LEER	n/a	BGS
5014	154	BGS
5016	177	BGS
5017	177	BGS
5021	169	BGS
5022	176	BGS
5023	176	BGS
5023-LEER	n/a	BGS
5025	176	BGS
5025-LEER	n/a	BGS
5028	175	BGS
5030	21	KM
5040	22	KM
5052	155	BGS
5052-14	QF6	BGS
5052-16	QF6	BGS
5052-17	QF6	BGS
5052-18	QF6	BGS
5052-19	QF6	BGS
5053	155	BGS
5054	155	BGS

Art.		BGS/ KM
5054-12	QF8	BGS
5054-14	QF8	BGS
5054-17	QF8	BGS
5054-19	QF8	BGS
5054-21	QF8	BGS
5054-22	QF8	BGS
5054-23	QF8	BGS
5054-24	QF8	BGS
5054-M16	QF8	BGS
5054-M18	QF8	BGS
5054-M24	QF8	BGS
5055	166	BGS
5058	437	BGS
5059	437	BGS
5060	437	BGS
5061	440	BGS
5062	440	BGS
5063	447	BGS
5064	448	BGS
5065	448	BGS
5066	448	BGS
5067	448	BGS
5068	440	BGS
5069	441	BGS
5070	22	KM
5071	440	BGS
5073	449	BGS
5074	449	BGS
5076	449	BGS
5077	450	BGS
5078	451	BGS
5079	451	BGS
5080	n/a	BGS
5081	238	BGS
5082	451	BGS
5083	451	BGS
5084	451	BGS
5085	452	BGS
5086	438	BGS
5087	438	BGS
5088	438	BGS
5089	452	BGS
5090	452	BGS
5091	452	BGS
5097	167	BGS
5098	168	BGS
5099	157	BGS
5100	166	BGS
5100-LEER	n/a	BGS
5101	166	BGS
5103	167	BGS
5103-TB70	QF7	BGS
5103-TB80	QF7	BGS
5103-TB90	QF7	BGS
5103-TB100	QF7	BGS
5103-LEER	n/a	BGS
5104	158	BGS
5105	163	BGS
5105-M4	QF6	BGS
5105-M5	QF6	BGS
5105-M6	QF6	BGS

Art.		BGS/ KM
5105-M8	QF6	BGS
5107	158	BGS
5108	169	BGS
5109	158	BGS
5110	QF6	BGS
5111	QF6	BGS
5112	QF6	BGS
5113	QF6	BGS
5114	QF6	BGS
5115	QF6	BGS
5151	159	BGS
5152	QF6	BGS
5153	QF6	BGS
5154	QF6	BGS
5155	QF6	BGS
5180	160	BGS
5180-M17	QF6	BGS
5181	156	BGS
5181-LEER	n/a	BGS
5182	165	BGS
5183	164	BGS
5184	152	BGS
5184-H7	QF6	BGS
5184-H10	QF6	BGS
5184-H11	QF6	BGS
5184-H13	QF6	BGS
5184-H17	QF6	BGS
5184-H19	QF6	BGS
5184-H22	QF6	BGS
5184-H24	QF6	BGS
5184-HB5	QF6	BGS
5184-LEER	n/a	BGS
5184-M9	QF6	BGS
5184-M10	QF6	BGS
5184-M12	QF6	BGS
5184-M14	QF6	BGS
5184-M18	QF8	BGS
5184-R7	QF7	BGS
5184-R8	QF7	BGS
5184-R9	QF7	BGS
5184-R10	QF7	BGS
5184-T30	QF7	BGS
5184-T40	QF7	BGS
5184-T45	QF7	BGS
5184-T50	QF7	BGS
5184-T55	QF7	BGS
5184-T60	QF7	BGS
5184-T70	QF7	BGS
5184-TB30	QF7	BGS
5184-TB80	QF7	BGS
5184-TS10	QF6	BGS
5184-TS15	QF6	BGS
5184-TS20	QF6	BGS
5184-TS25	QF6	BGS
5184-TS27	QF6	BGS
5184-TS30	QF6	BGS
5184-TS40	QF6	BGS
5184-TS45	QF6	BGS
5184-TS50	QF6	BGS
5185	163	BGS
5186	19	KM

Art.		BGS/ KM
5188	151	BGS
5189	166	BGS
5189-H14	QF6	BGS
5189-H17	QF6	BGS
5189-H19	QF6	BGS
5189-H22	QF6	BGS
5189-T60	QF7	BGS
5189-T70	QF7	BGS
5189-T80	QF7	BGS
5189-T90	QF7	BGS
5189-T100	QF7	BGS
5190	02_19	BGS
5191	02_19	BGS
5200	145	BGS
5208	147	BGS
5200-16	114	BGS
5200-17	114	BGS
5200-18	114	BGS
5200-19	114	BGS
5204	146	BGS
5204-10	QF5	BGS
5204-11	QF5	BGS
5204-12	QF5	BGS
5204-14	QF5	BGS
5204-16	QF5	BGS
5204-18	QF5	BGS
5204-20	QF5	BGS
5204-22	QF5	BGS
5204-24	QF5	BGS
5205	143	BGS
5205-8	QF4	BGS
5205-33	QF4	BGS
5205-34	QF4	BGS
5205-36	QF4	BGS
5205-38	QF4	BGS
5205-LEER	n/a	BGS
5206	144	BGS
5206-LEER	n/a	BGS
5207	144	BGS
5209	146	BGS
5210	QF4	BGS
5211	QF4	BGS
5212	QF4	BGS
5213	QF4	BGS
5214	QF4	BGS
5215	QF4	BGS
5216	QF4	BGS
5217	QF4	BGS
5218	QF4	BGS
5219	QF4	BGS
5221	QF4	BGS
5222	QF4	BGS
5224	QF4	BGS
5227	QF4	BGS
5230	QF4	BGS
5232	QF4	BGS
5233	QF4	BGS
5234	QF5	BGS
5240	149	BGS
5241	149	BGS
5242	149	BGS

Art.		BGS/ KM
5245	150	BGS
5245-LEER	n/a	BGS
5246	175	BGS
5246-1	174	BGS
5246-2	174	BGS
5246-E18	131	BGS
5246-E20	131	BGS
5246-E22	131	BGS
5246-E24	131	BGS
5246-H17	171	BGS
5246-H19	171	BGS
5246-H22	171	BGS
5246-H24	171	BGS
5246-T60	172	BGS
5246-T70	172	BGS
5246-T80	172	BGS
5246-T90	172	BGS
5246-T100	172	BGS
5246-LEER	n/a	BGS
5250	150	BGS
5250-E26	QF5	BGS
5250-E28	QF5	BGS
5250-E30	QF5	BGS
5250-E32	QF5	BGS
5251	134	BGS
5252	137	BGS
5253	141	BGS
5255	103	BGS
5258	80	BGS
5259	386	BGS
5260	118	BGS
5261	119	BGS
5262	118	BGS
5264	117	BGS
5264-17	QF5	BGS
5264-19	QF5	BGS
5264-21	QF5	BGS
5264-22	QF5	BGS
5264-TB	118	BGS
5265	116	BGS
5266	116	BGS
5266-10	QF5	BGS
5266-11	QF5	BGS
5266-12	QF5	BGS
5266-13	QF5	BGS
5266-14	QF5	BGS
5266-15	QF5	BGS
5266-16	QF5	BGS
5266-17	QF5	BGS
5266-19	QF5	BGS
5268	117	BGS
5268-22	QF5	BGS
5268-24	QF5	BGS
5268-27	QF5	BGS
5268-32	QF5	BGS
5268-36	QF5	BGS
5268-41	QF5	BGS
5269	117	BGS
5269-8	QF5	BGS
5269-21	QF5	BGS
5270	QF5	BGS

Art.		BGS/ KM
5271	QF5	BGS
5272	QF5	BGS
5273	QF5	BGS
5274	QF5	BGS
5275	QF5	BGS
5276	QF5	BGS
5277	QF5	BGS
5278	QF5	BGS
5279	QF5	BGS
5280	121	BGS
5281	119	BGS
5281-2	119	BGS
5281-3	119	BGS
5281-4	119	BGS
5281-6	119	BGS
5281-8	119	BGS
5281-10	119	BGS
5282	119	BGS
5284	120	BGS
5285	122	BGS
5289	120	BGS
5290	747	BGS
5290-2.6	747	BGS
5290-3.2	747	BGS
5290-4.5	747	BGS
5290-6.5	747	BGS
5290-8.25	747	BGS
5291	04_19	BGS
5334	145	BGS
5335	146	BGS
5336	QF5	BGS
5337	QF5	BGS
5338	QF5	BGS
5339	QF5	BGS
5340	QF5	BGS
5341	QF5	BGS
5342	QF5	BGS
5343	QF5	BGS
5344	QF5	BGS
5345	QF5	BGS
5346	QF5	BGS
5347	QF5	BGS
5348	QF5	BGS
5349	QF5	BGS
5350	619	BGS
5351	QF5	BGS
5352	QF5	BGS
5353	QF5	BGS
5360	441	BGS
5367	QF8	BGS
5369	QF8	BGS
5370	QF8	BGS
5371	QF8	BGS
5372	QF8	BGS
5373	QF8	BGS
5374	QF8	BGS
5375	QF8	BGS
5378	QF8	BGS
5380	162	BGS
5381	161	BGS
5381-M12	QF8	BGS

Art.		BGS/ KM
5381-M14	QF8	BGS
5381-M16	QF8	BGS
5381-M18	QF8	BGS
5404	460	BGS
5405	n/a	BGS
5410	458	BGS
5413	458	BGS
5416	458	BGS
5417	458	BGS
5420	520	BGS
5421	458	BGS
5422	521	BGS
5423	459	BGS
5430	606	BGS
5467	QF8	BGS
5469	QF8	BGS
5470	QF8	BGS
5471	QF8	BGS
5472	QF8	BGS
5473	QF8	BGS
5474	QF8	BGS
5475	QF8	BGS
5480	168	BGS
5480-T20	QF8	BGS
5480-T25	QF8	BGS
5480-T30	QF8	BGS
5480-T40	QF8	BGS
5480-T45	QF8	BGS
5480-T50	QF8	BGS
5480-T55	QF8	BGS
5480-T60	QF8	BGS
5480-T70	QF8	BGS
5481	158	BGS
5481-M5	QF8	BGS
5481-M6	QF8	BGS
5481-M7	QF8	BGS
5481-M8	QF8	BGS
5481-M10	QF8	BGS
5481-M12	QF8	BGS
5481-M14	QF8	BGS
5481-M17	QF8	BGS
5481-M19	QF8	BGS
5482	161	BGS
5482-M4	QF8	BGS
5482-M5	QF8	BGS
5482-M6	QF8	BGS
5482-M8	QF8	BGS
5482-M9	QF8	BGS
5482-M10	QF8	BGS
5482-M12	QF8	BGS
5482-M14	QF8	BGS
5482-M16	QF8	BGS
5483	163	BGS
5483-M5	QF8	BGS
5483-M6	QF8	BGS
5483-M7	QF8	BGS
5483-M8	QF8	BGS
5483-M9	QF8	BGS
5483-M10	QF8	BGS
5483-M12	QF8	BGS
5483-M13	QF8	BGS

Art.		BGS/ KM
5483-M14	QF8	BGS
5484	153	BGS
5485	157	BGS
5485-5	QF8	BGS
5485-6	QF8	BGS
5485-7	QF8	BGS
5485-8	QF8	BGS
5485-9	QF8	BGS
5485-10	QF8	BGS
5485-11	QF8	BGS
5485-12	QF8	BGS
5485-13	QF8	BGS
5485-14	QF8	BGS
5486	167	BGS
5486-T20	QF8	BGS
5486-T25	QF8	BGS
5486-T27	QF8	BGS
5486-T30	QF8	BGS
5486-T40	QF8	BGS
5486-T45	QF8	BGS
5486-T50	QF8	BGS
5486-T55	QF8	BGS
5486-T60	QF8	BGS
5486-T70	QF8	BGS
5486-T80	QF8	BGS
5487	161	BGS
5487-M4	QF8	BGS
5487-M5	QF8	BGS
5487-M6	QF8	BGS
5487-M8	QF8	BGS
5487-M10	QF8	BGS
5500	150	BGS
5500-17	QF4	BGS
5500-19	QF4	BGS
5500-21	QF4	BGS
5500-22	QF4	BGS
5500-24	QF4	BGS
5500-27	QF4	BGS
5500-30	QF4	BGS
5500-32	QF4	BGS
5500-33	QF4	BGS
5500-34	QF4	BGS
5500-36	QF4	BGS
5500-38	QF4	BGS
5500-41	QF4	BGS
5500-46	QF4	BGS
5500-50	QF4	BGS
5500-55	QF4	BGS
5500-60	QF4	BGS
5500-65	QF4	BGS
5500-70	QF4	BGS
5500-75	QF4	BGS
5500-80	QF4	BGS
5500-85	QF4	BGS
5500-90	QF4	BGS
5500-95	QF4	BGS
5500-100	QF4	BGS
5500-105	QF4	BGS
5500-110	QF4	BGS
5500-115	QF4	BGS
5545	01_19	BGS

Art.		BGS/ KM
5550	01_19	BGS
5555	01_19	BGS
5560	01_19	BGS
5565	01_19	BGS
5570	01_19	BGS
5580	01_19	BGS
5590	01_19	BGS
5600	01_19	BGS
5617	QF4	BGS
5618	QF4	BGS
5619	QF4	BGS
5621	QF4	BGS
5622	QF4	BGS
5624	QF4	BGS
5626	QF4	BGS
5627	QF4	BGS
5630	QF4	BGS
5632	QF4	BGS
5633	QF4	BGS
5634	QF4	BGS
5635	QF4	BGS
5636	QF4	BGS
5638	QF4	BGS
5641	QF4	BGS
5646	QF4	BGS
5648	QF4	BGS
5650	QF4	BGS
5655	QF4	BGS
5660	QF4	BGS
5717	QF4	BGS
5718	QF4	BGS
5719	QF4	BGS
5721	QF4	BGS
5722	QF4	BGS
5724	QF4	BGS
5726	QF4	BGS
5727	QF4	BGS
5730	QF4	BGS
5732	QF4	BGS
5733	QF4	BGS
5734	QF4	BGS
5736	QF4	BGS
5738	QF4	BGS
5741	QF4	BGS
5746	QF4	BGS
5750	QF4	BGS
5755	QF4	BGS
5760	QF4	BGS
5827	QF4	BGS
5830	QF4	BGS
5832	QF4	BGS
5833	QF4	BGS
5834	QF4	BGS
5835	QF4	BGS
5836	QF4	BGS
5838	QF4	BGS
5839	QF4	BGS
5841	QF4	BGS
5846	QF4	BGS
5850	QF4	BGS
5855	QF4	BGS

Art.		BGS/ KM
5856	QF4	BGS
5860	QF4	BGS
5865	QF4	BGS
5870	QF4	BGS
5875	QF4	BGS
5880	QF4	BGS
5885	QF4	BGS
5890	QF4	BGS
5895	QF4	BGS
5905	QF4	BGS
5910	QF4	BGS
5915	QF4	BGS
5920	QF4	BGS
6005	832	BGS
6110	29	KM
6111	29	KM
6112	29	KM
6113	29	KM
6120	559	BGS
6121	559	BGS
6122	559	BGS
6136	262	BGS
6137	262	BGS
6138	262	BGS
6140	558	BGS
6141	558	BGS
6160	558	BGS
6161	558	BGS
6162	558	BGS
6249	117	KM
6250	536	BGS
6250-1	536	BGS
6251	111	KM
6402	01_19	BGS
6403	136	BGS
6404	QF4	BGS
6405	QF4	BGS
6406	QF4	BGS
6407	QF4	BGS
6408	QF4	BGS
6410	QF4	BGS
6411	QF4	BGS
6412	QF4	BGS
6414	QF4	BGS
6416	QF4	BGS
6417	QF4	BGS
6418	QF4	BGS
6420	QF4	BGS
6422	QF4	BGS
6424	QF4	BGS
6425	142	BGS
6430	QF4	BGS
6431	QF4	BGS
6440	QF4	BGS
6442	QF4	BGS
6444	QF4	BGS
6446	QF4	BGS
6448	QF4	BGS
6450	QF4	BGS
6451	456	BGS
6452	456	BGS

Art.		BGS/ KM
6453	510	BGS
6454	510	BGS
6455	510	BGS
6456	543	BGS
6457	508	BGS
6460	QF4	BGS
6461	QF4	BGS
6462	QF4	BGS
6464	QF4	BGS
6466	QF4	BGS
6470	01_19	BGS
6471	01_19	BGS
6472	01_19	BGS
6473	01_19	BGS
6474	01_19	BGS
6475	01_19	BGS
6476	01_19	BGS
6477	01_19	BGS
6478	01_19	BGS
6479	01_19	BGS
6480	01_19	BGS
6481	01_19	BGS
6482	01_19	BGS
6483	01_19	BGS
6484	01_19	BGS
6508	10_18	BGS
6509	10_18	BGS
6510	10_18	BGS
6511	10_18	BGS
6512	10_18	BGS
6513	10_18	BGS
6514	10_18	BGS
6515	10_18	BGS
6516	10_18	BGS
6517	10_18	BGS
6518	10_18	BGS
6519	10_18	BGS
6521	10_18	BGS
6522	10_18	BGS
6524	10_18	BGS
6527	10_18	BGS
6530	10_18	BGS
6532	10_18	BGS
6540	10_18	BGS
6541	10_18	BGS
6550	07_18	BGS
6551	07_18	BGS
6552	07_18	BGS
6553	07_18	BGS
6554	07_18	BGS
6555	07_18	BGS
6556	07_18	BGS
6557	07_18	BGS
6558	07_18	BGS
6559	07_18	BGS
6560	07_18	BGS
6561	07_18	BGS
6562	07_18	BGS
6563	07_18	BGS
6564	07_18	BGS
6570	07_18	BGS

Art.		BGS/ KM
6571	07_18	BGS
6572	07_18	BGS
6573	07_18	BGS
6574	07_18	BGS
6575	07_18	BGS
6576	07_18	BGS
6577	07_18	BGS
6578	07_18	BGS
6579	07_18	BGS
6590	07_18	BGS
6591	07_18	BGS
6592	07_18	BGS
6593	07_18	BGS
6594	07_18	BGS
6608	04_19	BGS
6609	04_19	BGS
6610	04_19	BGS
6611	04_19	BGS
6612	04_19	BGS
6613	04_19	BGS
6614	04_19	BGS
6615	04_19	BGS
6616	04_19	BGS
6617	04_19	BGS
6618	04_19	BGS
6619	04_19	BGS
6670	04_19	BGS
6708	04_19	BGS
6709	04_19	BGS
6710	04_19	BGS
6711	04_19	BGS
6712	04_19	BGS
6713	04_19	BGS
6714	04_19	BGS
6715	04_19	BGS
6716	04_19	BGS
6717	04_19	BGS
6718	04_19	BGS
6719	04_19	BGS
6900-7	12_18	BGS
6900-8	12_18	BGS
6900-9	12_18	BGS
6900-10	12_18	BGS
6900-11	12_18	BGS
6900-12	12_18	BGS
6900-13	12_18	BGS
6900-14	12_18	BGS
6900-15	12_18	BGS
6900-16	12_18	BGS
6900-17	12_18	BGS
6900-18	12_18	BGS
6900-19	12_18	BGS
6902-7	12_18	BGS
6902-8	12_18	BGS
6902-10	12_18	BGS
6902-11	12_18	BGS
6902-12	12_18	BGS
6902-13	12_18	BGS
6902-14	12_18	BGS
6902-15	12_18	BGS
6902-16	12_18	BGS

Art.		BGS/ KM
6902-17	12_18	BGS
6902-18	12_18	BGS
6902-19	12_18	BGS
6902-21	12_18	BGS
6902-22	12_18	BGS
6904-10	12_18	BGS
6904-11	12_18	BGS
6904-12	12_18	BGS
6904-13	12_18	BGS
6904-14	12_18	BGS
6904-16	12_18	BGS
6904-17	12_18	BGS
6904-18	12_18	BGS
6904-19	12_18	BGS
6904-21	12_18	BGS
6904-22	12_18	BGS
7071	175	BGS
7071-LEER	n/a	BGS
7075	82	KM
7099	63	KM
7100	148	BGS
7101	116	BGS
7102	116	BGS
7103	116	BGS
7112	n/a	BGS
7150	383	BGS
7151	383	BGS
7152	384	BGS
7153	384	BGS
7154	370	BGS
7155	370	BGS
7156	341	BGS
7157	385	BGS
7158	383	BGS
7159	305	BGS
7073	21	KM
7180	442	BGS
7191	746	BGS
7195	746	BGS
7198	114	BGS
7199-LEER	n/a	BGS
7200	147	BGS
7200-LEER	n/a	BGS
7201	114	BGS
7202	114	BGS
7203	114	BGS
7204	114	BGS
7205	114	BGS
7206	114	BGS
7207	114	BGS
7208	114	BGS
7209	114	BGS
7210	QF4	BGS
7211	QF4	BGS
7212	QF4	BGS
7213	QF4	BGS
7214	QF4	BGS
7215	QF4	BGS
7216	QF4	BGS
7217	QF4	BGS
7218	QF4	BGS

Art.		BGS/ KM
7219	QF4	BGS
7221	QF4	BGS
7222	QF4	BGS
7224	QF4	BGS
7227	QF4	BGS
7230	QF4	BGS
7232	QF4	BGS
7236	QF4	BGS
7248	QF4	BGS
7300	148	BGS
7301	115	BGS
7302	115	BGS
7303	115	BGS
7304	115	BGS
7305	115	BGS
7306	115	BGS
7307	148	BGS
7309	115	BGS
7310	16	KM
7419	QF2	BGS
7421	QF2	BGS
7422	QF2	BGS
7424	QF2	BGS
7427	QF2	BGS
7430	QF2	BGS
7432	QF2	BGS
7434	QF2	BGS
7436	QF2	BGS
7438	QF2	BGS
7441	QF2	BGS
7446	QF2	BGS
7450	QF2	BGS
7460	129	BGS
7461	129	BGS
7462	129	BGS
7463	129	BGS
7464	129	BGS
7681	501	BGS
7682	117	KM
7683	116	KM
7685	569	BGS
7690	209	BGS
7691	209	BGS
7692	209	BGS
7693	209	BGS
7694	209	BGS
7695	209	BGS
7696	211	BGS
7697	211	BGS
7698	211	BGS
7699	211	BGS
7700	211	BGS
7701	211	BGS
7710	215	BGS
7710-1	215	BGS
7710-8x11	215	BGS
7710-12x17	215	BGS
7710-18x23	215	BGS
7710-24x29	215	BGS
7710-30x34	215	BGS
7711	715	BGS

Art.		BGS/ KM
7712	504	BGS
7713	209	BGS
7714	209	BGS
7715	33	KM
7715-34x38	02_19	KM
7715-39x43	02_19	KM
7715-44x48	02_19	KM
7715-49x53	02_19	KM
7715-54x58	02_19	KM
7716	209	BGS
7718	209	BGS
7719	504	BGS
7719-1	02_19	BGS
7721-X	215	BGS
7721-X-KAPPE	215	BGS
7723	211	BGS
7724	211	BGS
7726	211	BGS
7727	532	BGS
7728	211	BGS
7729	215	BGS
7730	34	KM
7731	217	BGS
7733	504	BGS
7734	216	BGS
7734-2	216	BGS
7735	503	BGS
7737	212	BGS
7738	212	BGS
7739	532	BGS
7741	214	BGS
7742	214	BGS
7743	584	BGS
7744	213	BGS
7745	501	BGS
7746	445	BGS
7747	445	BGS
7748	444	BGS
7748-A	04_18	BGS
7748-B	04_18	BGS
7748-C	04_18	BGS
7748-D	04_18	BGS
7748-E	04_18	BGS
7748-F	04_18	BGS
7748-G	04_18	BGS
7748-I	04_18	BGS
7748-K	04_18	BGS
7749	214	BGS
7750	213	BGS
7750-LEER	213	BGS
7752	216	BGS
7753	214	BGS
7754	04_18	BGS
7760	212	BGS
7760-LEER	212	BGS
7760-1	212	BGS
7760-2	212	BGS
7761	02_18	BGS
7763	555	BGS
7764	216	BGS
7770	217	BGS

Art.		BGS/ KM
7771	602	BGS
7771-1	602	BGS
7771-2	602	BGS
7771-3	602	BGS
7771-6	602	BGS
7771-4	602	BGS
7771-5	602	BGS
7772	503	BGS
7772-1	503	BGS
7772-2	503	BGS
7772-4	02_19	BGS
7774	502	BGS
7774-1	502	BGS
7774-2	502	BGS
7774-3	502	BGS
7775	04_18	KM
7776	503	BGS
7776-1	503	BGS
7777	600	BGS
7777-1	601	BGS
7777-2	601	BGS
7777-3	601	BGS
7777-4	601	BGS
7777-5	601	BGS
7779	217	BGS
7780	209	BGS
7781	210	BGS
7782	210	BGS
7783	210	BGS
7784	210	BGS
7785	211	BGS
7790	213	BGS
7791	213	BGS
7792	583	BGS
7793	583	BGS
7794	583	BGS
7795	583	BGS
7796	584	BGS
7797	584	BGS
7798	584	BGS
7800	199	BGS
7802	199	BGS
7802-1	199	BGS
7805	199	BGS
7805-1	199	BGS
7806	132	BGS
7807	132	BGS
7808	132	BGS
7809	132	BGS
7810	132	BGS
7811	132	BGS
7812	132	BGS
7813	132	BGS
7814	132	BGS
7824	132	BGS
7825	198	BGS
7826	131	BGS
7827	131	BGS
7828	131	BGS
7829	197	BGS
7830	66	KM

Art.		BGS/ KM
7840	288	BGS
7841	287	BGS
7842	63	KM
7844	67	KM
7844-T6	67	KM
7844-T7	67	KM
7844-T8	67	KM
7844-T9	67	KM
7844-T10	67	KM
7844-T15	67	KM
7844-T20	67	KM
7844-T25	67	KM
7844-T27	67	KM
7844-T30	67	KM
7844-T40	67	KM
7844-T45	67	KM
7845	68	KM
7846	286	BGS
7847	64	KM
7848	68	KM
7849	286	BGS
7849-T8	293	BGS
7849-T10	293	BGS
7849-T15	293	BGS
7849-T20	293	BGS
7849-T25	293	BGS
7849-T27	293	BGS
7849-T30	293	BGS
7849-T40	293	BGS
7880	66	KM
7880-LEER	n/a	BGS
7880-T10	66	KM
7880-T15	66	KM
7880-T20	66	KM
7880-T25	66	KM
7880-T27	66	KM
7880-T30	66	KM
7880-T40	66	KM
7880-T45	66	KM
7880-T50	66	KM
7881	72	KM
7882	62	KM
7882-2	62	KM
7882-2.5	62	KM
7882-3	62	KM
7882-4	62	KM
7882-5	62	KM
7882-6	62	KM
7882-7	62	KM
7882-8	62	KM
7882-10	62	KM
7890	71	KM
7895	284	BGS
7895-LEER	284	BGS
7910	289	BGS
7911	289	BGS
7912	289	BGS
7913	289	BGS
7914	289	BGS
7915	289	BGS
7916	291	BGS

Art.		BGS/ KM
7917	291	BGS
7918	291	BGS
7919	291	BGS
7920	291	BGS
7921	291	BGS
7924	283	BGS
7931	290	BGS
7932	290	BGS
7933	290	BGS
7934	288	BGS
7935	288	BGS
7936	290	BGS
7937	290	BGS
7943	283	BGS
7944	283	BGS
7946	71	KM
7946-3	65	KM
7946-4	65	KM
7946-5	65	KM
7946-6	65	KM
7946-8	65	KM
7946-PH0	65	KM
7946-PH1	65	KM
7946-PH2	65	KM
7946-PH3	65	KM
7946-PZ1	65	KM
7946-PZ2	65	KM
7946-PZ3	65	KM
7952	295	BGS
7955	260	BGS
7957	64	KM
7958	260	BGS
7959	68	KM
7961	52	KM
7962	262	BGS
7963	263	BGS
7964	52	KM
7965	263	BGS
7966	260	BGS
7967	285	BGS
7968	69	KM
7969	69	KM
7970	54	KM
7971	261	BGS
7972	54	KM
7973	261	BGS
7975	261	BGS
7976	261	BGS
7977	43	KM
7980	260	BGS
7982	71	KM
7983	571	BGS
7985	284	BGS
7985-1	198	BGS
7985-25X27	284	BGS
7985-LEER	284	BGS
7987	572	BGS
7988	74	KM
7988-1	74	KM
7991	572	BGS
7992	228	BGS

Art.		BGS/ KM
7993	571	BGS
7995	572	BGS
7996	571	BGS
7997	570	BGS
7998	572	BGS
7999	566	BGS
8000	571	BGS
8001	566	BGS
8002	565	BGS
8003	566	BGS
8004	566	BGS
8005	819	BGS
8005-10	819	BGS
8005-12	819	BGS
8006	566	BGS
8007	816	BGS
8007-2	02_18	BGS
8008	817	BGS
8008-1	817	BGS
8008-2	817	BGS
8008-35	817	BGS
8008-52	817	BGS
8008-55	817	BGS
8008-56	817	BGS
8008-69	817	BGS
8008-70	817	BGS
8008-72	817	BGS
8008-M10K	817	BGS
8008-M10X1.0	817	BGS
8009	616	BGS
8011	493	BGS
8012	615	BGS
8014	492	BGS
8015	590	BGS
8016	136	KM
8017	294	BGS
8018	487	BGS
8022	567	BGS
8023	702	BGS
8025	562	BGS
8026	816	BGS
8026-1	816	BGS
8027	593	BGS
8027-1	593	BGS
8027-2	593	BGS
8027-3	593	BGS
8027-4	593	BGS
8027-5	593	BGS
8027-6	593	BGS
8027-7	593	BGS
8027-8	593	BGS
8027-9	593	BGS
8027-10	593	BGS
8027-11	593	BGS
8027-12	593	BGS
8027-13	593	BGS
8027-14	593	BGS
8027-15	593	BGS
8027-16	593	BGS
8027-17	593	BGS
8027-18	593	BGS

Art.		BGS/ KM
8027-19	593	BGS
8027-30	593	BGS
8027-31	593	BGS
8027-32	593	BGS
8027-33	593	BGS
8027-LEER	593	BGS
8028	821	BGS
8029	167	KM
8030	756	BGS
8031	168	KM
8033	57	KM
8034	57	KM
8035	590	BGS
8036	616	BGS
8037	815	BGS
8037-1	815	BGS
8037-2	10_18	BGS
8038	833	BGS
8039	886	BGS
8040	164	KM
8041	164	KM
8042	882	BGS
8043	871	BGS
8044	862	BGS
8045	860	BGS
8045-LEER	860	BGS
8046	885	BGS
8047	873	BGS
8048	870	BGS
8049	885	BGS
8050	105	KM
8051	107	KM
8052	867	BGS
8053	865	BGS
8054	872	BGS
8055	877	BGS
8057	119	KM
8058	859	BGS
8059	863	BGS
8060	226	BGS
8061	861	BGS
8062	48	KM
8063	48	KM
8065	880	BGS
8065-1	880	BGS
8066	470	BGS
8066-1	470	BGS
8066-2	470	BGS
8066-3	470	BGS
8067	833	BGS
8067-1	833	BGS
8067-2	833	BGS
8068	197	KM
8071-2	470	BGS
8072	192	KM
8073	196	KM
8074	190	KM
8076	188	KM
8077	149	KM
8078	886	BGS
8080	468	BGS

Art.		BGS/ KM
8080-31	468	BGS
8080-31-1	468	BGS
8080-32	468	BGS
8080-32-1	468	BGS
8081	181	KM
8082	181	KM
8083	187	KM
8084	187	KM
8085	187	KM
8086	187	KM
8087	871	BGS
8088	177	KM
8090	176	KM
8091	177	KM
8092	177	KM
8093	177	KM
8094	177	KM
8095	877	BGS
8095-8x12	877	BGS
8095-10x16	877	BGS
8095-12x20	877	BGS
8095-16x25	877	BGS
8095-20x32	877	BGS
8095-25x40	877	BGS
8095-30x45	877	BGS
8095-32x50	877	BGS
8095-40x60	877	BGS
8095-50x70	877	BGS
8095-60x80	877	BGS
8096	594	BGS
8098	592	BGS
8098-1	592	BGS
8098-2	592	BGS
8098-3	592	BGS
8098-20	592	BGS
8098-21	592	BGS
8098-22	592	BGS
8098-LEER	592	BGS
8100	332	BGS
8101	614	BGS
8101-1	614	BGS
8101-2	614	BGS
8101-LEER	614	BGS
8102	613	BGS
8103	614	BGS
8105	862	BGS
8106	127	KM
8107	866	BGS
8109	883	BGS
8111	886	BGS
8112	870	BGS
8113	866	BGS
8114	880	BGS
8117	887	BGS
8118	792	BGS
8119	792	BGS
8120	868	BGS
8121	863	BGS
8122	702	BGS
8123	882	BGS
8124	884	BGS

Art.		BGS/ KM
8125	870	BGS
8126	884	BGS
8127	884	BGS
8128	193	KM
8129	852	BGS
8131	194	KM
8132	869	BGS
8133	881	BGS
8134	191	KM
8135	881	BGS
8136	881	BGS
8137	871	BGS
8138	887	BGS
8139	887	BGS
8140	129	KM
8141	872	BGS
8142	867	BGS
8143	865	BGS
8144	869	BGS
8145	682	BGS
8147	494	BGS
8147-T30	494	BGS
8148	648	BGS
8148-13	648	BGS
8149	562	BGS
8150	702	BGS
8151-1	666	BGS
8151-2	666	BGS
8151-3	666	BGS
8151-6	666	BGS
8151-8	666	BGS
8151-10	666	BGS
8151-12	666	BGS
8151-17	666	BGS
8151-19	666	BGS
8151-22	666	BGS
8151-LEER	n/a	BGS
8152	673	BGS
8152-7	01_19	BGS
8152-19	673	BGS
8152-30	673	BGS
8154	679	BGS
8154-1	679	BGS
8154-2	679	BGS
8154-4	679	BGS
8154-11	679	BGS
8154-15	679	BGS
8154-LEER	679	BGS
8155	692	BGS
8155-01	692	BGS
8155-1	692	BGS
8155-2	692	BGS
8155-5	692	BGS
8155-6	692	BGS
8155-8	692	BGS
8155-9	692	BGS
8155-12	692	BGS
8155-15	692	BGS
8155-16	692	BGS
8155-17	692	BGS
8155-18	692	BGS

Art.		BGS/ KM
8155-19	692	BGS
8155-20	692	BGS
8155-23	692	BGS
8155-25	692	BGS
8155-26	692	BGS
8155-LEER	692	BGS
8156	653	BGS
8156-2	653	BGS
8156-3	653	BGS
8156-4	653	BGS
8156-5	653	BGS
8156-6	653	BGS
8156-12	653	BGS
8156-14	653	BGS
8156-17	653	BGS
8156-18	653	BGS
8156-19	653	BGS
8157	690	BGS
8157-1	690	BGS
8158	697	BGS
8159-6	648	BGS
8159-16	648	BGS
8159-17	648	BGS
8160	QF9	BGS
8161	QF9	BGS
8162	QF9	BGS
8163	QF9	BGS
8164	QF9	BGS
8165	QF9	BGS
8166	QF9	BGS
8167	QF9	BGS
8168	QF9	BGS
8169	QF9	BGS
8170	QF9	BGS
8171	442	BGS
8172	QF9	BGS
8173	QF9	BGS
8174	QF9	BGS
8176	QF9	BGS
8177	QF9	BGS
8178	QF9	BGS
8179	QF9	BGS
8180	QF9	BGS
8181	QF9	BGS
8182	QF9	BGS
8183	04_19	BGS
8185	QF9	BGS
8186	QF9	BGS
8187	QF9	BGS
8188	QF9	BGS
8189	QF9	BGS
8190	QF9	BGS
8191	QF9	BGS
8192	QF9	BGS
8193	QF9	BGS
8194	QF9	BGS
8195	QF9	BGS
8196	QF9	BGS
8197	QF9	BGS
8198	QF9	BGS
8199	QF9	BGS

Art.		BGS/ KM
8201	174	BGS
8202	195	BGS
8204	28	KM
8208	QF9	BGS
8209	QF9	BGS
8210	323	BGS
8212	43	KM
8213	174	BGS
8214	195	BGS
8214-1	194	BGS
8215	652	BGS
8215-1	652	BGS
8216	697	BGS
8217	QF9	BGS
8218	653	BGS
8219	696	BGS
8220	734	BGS
8221	716	BGS
8224	716	BGS
8224-1	716	BGS
8224-2	716	BGS
8225	174	BGS
8227	665	BGS
8228	466	BGS
8229	467	BGS
8231	515	BGS
8232	703	BGS
8233	703	BGS
8234	703	BGS
8235	819	BGS
8236	819	BGS
8237	608	BGS
8237-29	608	BGS
8238	728	BGS
8239	703	BGS
8240	643	BGS
8241	696	BGS
8242	442	BGS
8243	690	BGS
8244	608	BGS
8245	502	BGS
8246	581	BGS
8247	493	BGS
8248	447	BGS
8249	704	BGS
8250	599	BGS
8251	174	BGS
8252	728	BGS
8253	537	BGS
8253-1	537	BGS
8253-2	537	BGS
8253-3	537	BGS
8254	538	BGS
8256	600	BGS
8257	839	BGS
8258	600	BGS
8259	802	BGS
8260	615	BGS
8261	694	BGS
8262	502	BGS
8264	747	BGS

Art.		BGS/ KM
8265	126	BGS
8265-1	126	BGS
8265-2	126	BGS
8265-3	126	BGS
8265-4	126	BGS
8265-5	126	BGS
8265-6	126	BGS
8265-7	126	BGS
8265-8	126	BGS
8265-9	126	BGS
8265-10	126	BGS
8265-11	126	BGS
8266-1	127	BGS
8266-2	127	BGS
8266-3	127	BGS
8266-4	127	BGS
8266-5	127	BGS
8266-6	127	BGS
8266-7	127	BGS
8266-8	127	BGS
8266-9	127	BGS
8266-10	127	BGS
8267	530	BGS
8268	459	BGS
8269	459	BGS
8270	540	BGS
8271	805	BGS
8272	322	BGS
8273	217	BGS
8274	615	BGS
8275	705	BGS
8278	691	BGS
8279	696	BGS
8281	691	BGS
8283	525	BGS
8284	526	BGS
8285	590	BGS
8286	524	BGS
8289	716	BGS
8290	620	BGS
8291	606	BGS
8292	506	BGS
8293	515	BGS
8293-1	516	BGS
8297	752	BGS
8297-1	752	BGS
8297-2	752	BGS
8297-3	752	BGS
8297-4	752	BGS
8299	695	BGS
8301	735	BGS
8301-1	734	BGS
8302	628	BGS
8303	667	BGS
8304	691	BGS
8304-LEER	691	BGS
8305	528	BGS
8306	532	BGS
8306-LEER	532	BGS
8307	511	BGS
8308	490	BGS

Art.		BGS/ KM
8309	608	BGS
8310	464	BGS
8310-1	464	BGS
8310-2	464	BGS
8310-3	464	BGS
8310-4	464	BGS
8310-5	464	BGS
8310-6	464	BGS
8312	496	BGS
8313	496	BGS
8314	616	BGS
8315	468	BGS
8315-3	468	BGS
8315-4	04_18	BGS
8316	469	BGS
8317	654	BGS
8319	452	BGS
8319-1	452	BGS
8320	525	BGS
8321	540	BGS
8322	540	BGS
8323	540	BGS
8324	540	BGS
8328	270	BGS
8329	270	BGS
8330	275	BGS
8332	02_19	BGS
8334	704	BGS
8335	704	BGS
8340	270	BGS
8340-1	270	BGS
8341	269	BGS
8341-1	269	BGS
8343	807	BGS
8344	269	BGS
8344-1	269	BGS
8345	808	BGS
8346	531	BGS
8347	361	BGS
8348	716	BGS
8349	607	BGS
8351	603	BGS
8355	618	BGS
8356	755	BGS
8357	726	BGS
8359	363	BGS
8360	441	BGS
8362	439	BGS
8363	233	BGS
8364	233	BGS
8365	837	BGS
8366	763	BGS
8367	835	BGS
8367-1	835	BGS
8369	270	BGS
8370	754	BGS
8371	754	BGS
8372	915	BGS
8373	443	BGS
8374	754	BGS
8375	745	BGS

Art.		BGS/ KM
8376	745	BGS
8377	797	BGS
8377-27	797	BGS
8377-36	797	BGS
8378	118	BGS
8379	342	BGS
8380	570	BGS
8381	412	BGS
8382	414	BGS
8382-1	02_18	BGS
8383	07_18	BGS
8384	797	BGS
8385	500	BGS
8386	889	BGS
8386-1	889	BGS
8388	849	BGS
8389	454	BGS
8389-1	454	BGS
8390	803	BGS
8391	444	BGS
8392	267	BGS
8393	267	BGS
8394	267	BGS
8395	803	BGS
8396	803	BGS
8397	821	BGS
8398	76	BGS
8400	817	BGS
8401	818	BGS
8403	471	BGS
8403-1	471	BGS
8405	251	BGS
8406	756	BGS
8407	682	BGS
8408	483	BGS
8408-1	483	BGS
8408-2	483	BGS
8408-3	483	BGS
8409	359	BGS
8410	519	BGS
8411	519	BGS
8412	360	BGS
8413	674	BGS
8414	360	BGS
8415	578	BGS
8416	620	BGS
8417	682	BGS
8418	677	BGS
8419	442	BGS
8420	671	BGS
8421	680	BGS
8422	676	BGS
8424	455	BGS
8425	814	BGS
8426	834	BGS
8427	265	BGS
8432	605	BGS
8433	605	BGS
8434	605	BGS
8435	605	BGS
8436	420	BGS

Art.		BGS/ KM
8437	542	BGS
8438	683	BGS
8439	208	BGS
8440	599	BGS
8441	767	BGS
8442	326	BGS
8443	695	BGS
8444	729	BGS
8446-1	757	BGS
8447	751	BGS
8448	274	BGS
8449	162	BGS
8450	605	BGS
8451	590	BGS
8452	294	BGS
8453	845	BGS
8454	735	BGS
8457	446	BGS
8459	454	BGS
8460	570	BGS
8460-1	02_18	BGS
8461	443	BGS
8462	120	BGS
8463	355	BGS
8463-1	355	BGS
8463-2	355	BGS
8463-3	355	BGS
8463-4	355	BGS
8464	543	BGS
8465	446	BGS
8466	445	BGS
8467	553	BGS
8468	830	BGS
8469	607	BGS
8470	362	BGS
8471	396	BGS
8472	393	BGS
8473	393	BGS
8474	443	BGS
8476	261	BGS
8477	173	BGS
8478	888	BGS
8479	591	BGS
8480	551	BGS
8481	552	BGS
8482	516	BGS
8483	193	BGS
8484	333	BGS
8484-1	333	BGS
8485	336	BGS
8486	545	BGS
8487	01_19	BGS
8489	343	BGS
8490	343	BGS
8491	767	BGS
8492	761	BGS
8493	767	BGS
8494	236	BGS
8495	428	BGS
8496	427	BGS
8497	392	BGS

Art.		BGS/ KM
8500	641	BGS
8501	717	BGS
8501-1	717	BGS
8501-2	717	BGS
8502	n/a	BGS
8504	839	BGS
8505	786	BGS
8505-1	786	BGS
8505-2	04_19	BGS
8505-13P	786	BGS
8508	576	BGS
8509	444	BGS
8510	444	BGS
8511	441	BGS
8512	333	BGS
8512-1	333	BGS
8514	460	BGS
8514-1	460	BGS
8514-2	460	BGS
8514-3	460	BGS
8514-4	460	BGS
8514-5	460	BGS
8514-6	460	BGS
8514-7	460	BGS
8514-8	460	BGS
8514-9	460	BGS
8515	762	BGS
8516	823	BGS
8517	806	BGS
8519	471	BGS
8520	526	BGS
8522	705	BGS
8526	820	BGS
8527	713	BGS
8528	519	BGS
8529	676	BGS
8530	688	BGS
8531	705	BGS
8532	706	BGS
8533	657	BGS
8534	629	BGS
8535	618	BGS
8536	792	BGS
8536-1	792	BGS
8537	792	BGS
8537-1	792	BGS
8539	450	BGS
8540	418	BGS
8540-1	418	BGS
8541	520	BGS
8542	322	BGS
8544-1	778	BGS
8544-2	778	BGS
8545	778	BGS
8547	120	BGS
8549	121	BGS
8551	717	BGS
8552	723	BGS
8553	620	BGS
8554	781	BGS
8555	706	BGS

Art.		BGS/ KM
8557	814	BGS
8557-1	814	BGS
8558	143	KM
8559	400	BGS
8560	274	BGS
8561	610	BGS
8562	713	BGS
8563	724	BGS
8563-1	724	BGS
8565	701	BGS
8568	757	BGS
8569	757	BGS
8570	629	BGS
8571	605	BGS
8572	506	BGS
8573	627	BGS
8575	521	BGS
8576	328	BGS
8577	680	BGS
8578	654	BGS
8579	544	BGS
8580	419	BGS
8580-1	419	BGS
8580-3	419	BGS
8580-4	419	BGS
8580-5	419	BGS
8582	874	BGS
8583	567	BGS
8584	403	BGS
8589	549	BGS
8590	280	BGS
8591	280	BGS
8592	281	BGS
8595	131	KM
8596	804	BGS
8598	32	KM
8599	594	BGS
8599-1	594	BGS
8599-2	594	BGS
8599-3	594	BGS
8600	360	BGS
8602	638	BGS
8603	422	BGS
8604	889	BGS
8604-1	889	BGS
8605	322	BGS
8606	762	BGS
8608	129	BGS
8611	586	BGS
8612	428	BGS
8613	446	BGS
8615	466	BGS
8616	191	BGS
8617	192	BGS
8618	170	BGS
8620	378	BGS
8621	228	BGS
8622	712	BGS
8624	n/a	BGS
8625	43	KM
8626	236	BGS

Art.		BGS/ KM
8627	595	BGS
8628	272	BGS
8629	283	BGS
8629-1	288	BGS
8629-2	288	BGS
8629-3	288	BGS
8629-4	288	BGS
8629-5	288	BGS
8629-6	288	BGS
8629-7	288	BGS
8629-8	288	BGS
8630	620	BGS
8631	582	BGS
8632	582	BGS
8633	506	BGS
8634	438	BGS
8635	145	KM
8640	126	KM
8641	497	BGS
8642	491	BGS
8643	341	BGS
8644	267	BGS
8646	297	BGS
8647	752	BGS
8647-1	752	BGS
8648	752	BGS
8648-1	752	BGS
8649	752	BGS
8649-1	752	BGS
8650	752	BGS
8650-1	752	BGS
8650-2	752	BGS
8651	752	BGS
8651-1	752	BGS
8651-2	752	BGS
8651-3	752	BGS
8652	249	BGS
8653	753	BGS
8655	839	BGS
8656	125	BGS
8656-3	125	BGS
8656-4	125	BGS
8656-5	125	BGS
8656-6	125	BGS
8656-7	125	BGS
8656-8	125	BGS
8656-9	125	BGS
8656-10	125	BGS
8657	750	BGS
8658	838	BGS
8661	202	BGS
8662	741	BGS
8665	322	BGS
8665-24	323	BGS
8665-27	323	BGS
8665-30	323	BGS
8665-32	323	BGS
8667	796	BGS
8668	730	BGS
8669	649	BGS
8670	554	BGS

Art.		BGS/ KM
8671	657	BGS
8672	657	BGS
8673	658	BGS
8674	717	BGS
8675	265	BGS
8676	135	KM
8676-LEER	135	KM
8677	801	BGS
8678	736	BGS
8679	510	BGS
8681	526	BGS
8682	557	BGS
8683	528	BGS
8684	575	BGS
8686	372	BGS
8687	557	BGS
8688	410	BGS
8688-23	01_19	BGS
8689	488	BGS
8690	706	BGS
8691	241	BGS
8693	846	BGS
8695	788	BGS
8697	668	BGS
8698	751	BGS
8698-1	751	BGS
8698-2	751	BGS
8698-3	751	BGS
8698-4	751	BGS
8699	748	BGS
8700	528	BGS
8702	419	BGS
8702-1	02_18	BGS
8703	574	BGS
8704	464	BGS
8704-1	464	BGS
8705	367	BGS
8706	400	BGS
8707	548	BGS
8707-1	548	BGS
8707-2	548	BGS
8708	541	BGS
8709	539	BGS
8710	628	BGS
8713	576	BGS
8714	833	BGS
8715	533	BGS
8716	546	BGS
8717	414	BGS
8717-1	414	BGS
8717-2	414	BGS
8718	467	BGS
8719	781	BGS
8720	782	BGS
8721	671	BGS
8722	749	BGS
8723	604	BGS
8724	630	BGS
8725	650	BGS
8726	445	BGS
8727	802	BGS

Art.		BGS/ KM
8728	802	BGS
8729	453	BGS
8731	472	BGS
8732	270	BGS
8733	550	BGS
8734	549	BGS
8735	550	BGS
8736	553	BGS
8737	539	BGS
8738	538	BGS
8739	538	BGS
8740	650	BGS
8741	650	BGS
8742	638	BGS
8743	630	BGS
8744	639	BGS
8745	639	BGS
8746	631	BGS
8747	631	BGS
8748	631	BGS
8749	619	BGS
8750	723	BGS
8750-1	723	BGS
8751	706	BGS
8752	361	BGS
8754	808	BGS
8758	n/a	BGS
8759	721	BGS
8760	523	BGS
8761	798	BGS
8763	563	BGS
8764	365	BGS
8765	800	BGS
8766	843	BGS
8766-1	843	BGS
8767	214	BGS
8768	214	BGS
8769	697	BGS
8770	547	BGS
8771	612	BGS
8772	741	BGS
8774	353	BGS
8774-1	353	BGS
8775	785	BGS
8776	546	BGS
8777	724	BGS
8778	537	BGS
8779	541	BGS
8780	542	BGS
8781	517	BGS
8782	607	BGS
8784	n/a	BGS
8785	668	BGS
8786	643	BGS
8787	533	BGS
8788	539	BGS
8789	569	BGS
8790	879	BGS
8790-3	879	BGS
8790-5	879	BGS
8790-6	879	BGS

Art.		BGS/ KM
8790-8	879	BGS
8790-10	879	BGS
8791	130	BGS
8792	533	BGS
8793	463	BGS
8794	632	BGS
8796	529	BGS
8799	328	BGS
8802	439	BGS
8804	358	BGS
8805	357	BGS
8806	143	BGS
8807	850	BGS
8808	28	KM
8815	651	BGS
8816	580	BGS
8817	569	BGS
8819	622	BGS
8819-1	622	BGS
8820	84	BGS
8820-LEER	n/a	BGS
8821	797	BGS
8822	837	BGS
8823	837	BGS
8825	122	KM
8827	623	BGS
8829	552	BGS
8830	730	BGS
8831	374	BGS
8831-1	374	BGS
8831-2	374	BGS
8832	639	BGS
8833	293	BGS
8834	632	BGS
8835	678	BGS
8835-1	678	BGS
8836	677	BGS
8837	678	BGS
8839	698	BGS
8840	194	BGS
8841	413	BGS
8842	545	BGS
8842-LEER	01_19	BGS
8843	547	BGS
8845	546	BGS
8846	548	BGS
8849	551	BGS
8850	672	BGS
8851	496	BGS
8852	395	BGS
8853	410	BGS
8853-1	410	BGS
8854	718	BGS
8855	576	BGS
8856	204	BGS
8857	669	BGS
8858	901	BGS
8859	800	BGS
8860	568	BGS
8863	737	BGS
8864	473	BGS

Art.		BGS/ KM
8867	439	BGS
8868	372	BGS
8868-1	372	BGS
8869	372	BGS
8869-1	372	BGS
8870	621	BGS
8871	706	BGS
8872	378	BGS
8873	378	BGS
8874	655	BGS
8875	551	BGS
8877	510	BGS
8878	707	BGS
8879	838	BGS
8880-1	56	BGS
8880-9	n/a	BGS
8880-11	n/a	BGS
8880-14	n/a	BGS
8880-15	n/a	BGS
8880-16	n/a	BGS
8880-18	n/a	BGS
8881	844	BGS
8882	698	BGS
8883	707	BGS
8884	612	BGS
8885	168	BGS
8886	168	BGS
8887	157	BGS
8889	836	BGS
8890	826	BGS
8891	457	BGS
8892	330	BGS
8893	376	BGS
8894	515	BGS
8895	444	BGS
8896	462	BGS
8897	472	BGS
8898	787	BGS
8899	787	BGS
8900	841	BGS
8901	841	BGS
8902	805	BGS
8903	218	BGS
8904	842	BGS
8905	665	BGS
8906	842	BGS
8907	639	BGS
8908	841	BGS
8910	580	BGS
8914	07_18	BGS
8917	465	BGS
8918	465	BGS
8918-1	02_18	BGS
8918-2	02_18	BGS
8918-3	02_18	BGS
8919	836	BGS
8920	588	BGS
8921	640	BGS
8922	699	BGS
8922-1	02_19	BGS
8924	699	BGS

Art.		BGS/ KM
8925	07_18	BGS
8926	07_18	BGS
8927	07_18	BGS
8928	700	BGS
8929	486	BGS
8932	123	BGS
8933	123	BGS
8934	589	BGS
8935	621	BGS
8936	376	BGS
8937	823	BGS
8939	453	BGS
8940	707	BGS
8942	782	BGS
8943	421	BGS
8944	446	BGS
8946	707	BGS
8951	700	BGS
8952	549	BGS
8953	623	BGS
8954	609	BGS
8955	229	BGS
8956	396	BGS
8957	723	BGS
8958	725	BGS
8959	461	BGS
8960	846	BGS
8961	747	BGS
8962	123	BGS
8963	123	BGS
8964	218	BGS
8965	396	BGS
8966	776	BGS
8967	807	BGS
8968	527	BGS
8969	619	BGS
8971	672	BGS
8972	672	BGS
8973	672	BGS
8974	658	BGS
8976	496	BGS
8977	708	BGS
8978	675	BGS
8979	801	BGS
8980	818	BGS
8981	484	BGS
8982	400	BGS
8983	531	BGS
8984	598	BGS
8985	220	BGS
8986	220	BGS
8989-1	n/a	BGS
8990	847	BGS
8991	789	BGS
8992	847	BGS
8993	823	BGS
8994	133	BGS
8995	133	BGS
8996	133	BGS
8998	713	BGS
8999	112	KM

Art.		BGS/ KM
8999-1	02_18	KM
9000	803	BGS
9001	469	BGS
9002	421	BGS
9003	718	BGS
9004	173	BGS
9005	660	BGS
9006	659	BGS
9007	718	BGS
9008	661	BGS
9009	659	BGS
9010	660	BGS
9015	719	BGS
9016	n/a	BGS
9017	611	BGS
9019	321	BGS
9021	621	BGS
9023	525	BGS
9024	268	BGS
9025	842	BGS
9026	745	BGS
9028	492	BGS
9029	105	BGS
9031	521	BGS
9038	736	BGS
9041	852	BGS
9042	853	BGS
9043	853	BGS
9044	854	BGS
9045	854	BGS
9046	855	BGS
9047	855	BGS
9048	856	BGS
9049	856	BGS
9051	856	BGS
9052	857	BGS
9053	857	BGS
9054	858	BGS
9055	858	BGS
9057	859	BGS
9060	790	BGS
9061	592	BGS
9063	618	BGS
9064	701	BGS
9065	719	BGS
9066	719	BGS
9069	818	BGS
9070	87	KM
9071	633	BGS
9072	656	BGS
9073	743	BGS
9074	829	BGS
9077	798	BGS
9081	259	BGS
9082	259	BGS
9083	259	BGS
9084	259	BGS
9085	259	BGS
9086	540	BGS
9087	405	BGS
9088	563	BGS

Art.		BGS/ KM
9089	127	BGS
9090	184	BGS
9091	720	BGS
9092	n/a	BGS
9093	363	BGS
9094	720	BGS
9095	457	BGS
9096	343	BGS
9097	344	BGS
9098	344	BGS
9099	124	BGS
9101	541	BGS
9102	133	BGS
9104	136	BGS
9105	137	BGS
9106	138	BGS
9107	140	BGS
9108	138	BGS
9109	140	BGS
9110	137	BGS
9111	155	KM
9112	138	BGS
9113	139	BGS
9114	141	BGS
9115	567	BGS
9120	189	KM
9127	189	KM
9132	136	KM
9133	777	BGS
9134	777	BGS
9135	777	BGS
9136	141	KM
9137	777	BGS
9137-1	777	BGS
9137-2	777	BGS
9137-3	777	BGS
9137-4	777	BGS
9144	01_19	BGS
9146	677	BGS
9147	577	BGS
9148	585	BGS
9149	60	KM
9150	197	BGS
9151	294	BGS
9152	469	BGS
9153	617	BGS
9154	741	BGS
9155	576	BGS
9156	533	BGS
9157	736	BGS
9158	170	BGS
9159	479	BGS
9160	188	BGS
9161	188	BGS
9162	194	BGS
9163	799	BGS
9164	758	BGS
9170	121	BGS
9171	487	BGS
9172	496	BGS
9174	718	BGS

Art.		BGS/ KM
9175	623	BGS
9176	254	BGS
9177	488	BGS
9179	421	BGS
9180	422	BGS
9181	50	KM
9182	421	BGS
9183	280	BGS
9184	280	BGS
9185	723	BGS
9186	234	BGS
9187	234	BGS
9190	426	BGS
9191	8	KM
9192	9	KM
9193	197	BGS
9194	197	BGS
9195	197	BGS
9197	139	KM
9199	376	BGS
9201	800	BGS
9202	720	BGS
9203	497	BGS
9204	708	BGS
9205	497	BGS
9206	711	BGS
9207	459	BGS
9209	708	BGS
9210	808	BGS
9212	621	BGS
9213	652	BGS
9214	642	BGS
9215	663	BGS
9216	644	BGS
9217	644	BGS
9218	678	BGS
9220	548	BGS
9222	720	BGS
9223	640	BGS
9224	720	BGS
9225	646	BGS
9226	647	BGS
9227	644	BGS
9228	647	BGS
9229	647	BGS
9230	758	BGS
9231	758	BGS
9232	137	KM
9232-1	137	KM
9233	759	BGS
9233-1	759	BGS
9233-2	759	BGS
9234	761	BGS
9234-1	761	BGS
9234-2	761	BGS
9235	761	BGS
9236	890	BGS
9237	762	BGS
9238	763	BGS
9239	759	BGS
9240-1	n/a	BGS

Art.		BGS/ KM
9242-1	n/a	BGS
9242-2	n/a	BGS
9244	454	BGS
9245	760	BGS
9245-1	760	BGS
9246	894	BGS
9246-1	894	BGS
9246-2	894	BGS
9246-3	894	BGS
9247-1	n/a	BGS
9247-2	n/a	BGS
9247-3	n/a	BGS
9248	893	BGS
9249	760	BGS
9252	893	BGS
9254	761	BGS
9255	893	BGS
9258	430	BGS
9258-1	430	BGS
9258-2	430	BGS
9259	430	BGS
9259-1	430	BGS
9259-2	430	BGS
9259-3	430	BGS
9259-4	430	BGS
9259-5	430	BGS
9259-6	430	BGS
9260	10_18	KM
9260-1	10_18	KM
9260-2	10_18	KM
9261	646	BGS
9262	646	BGS
9263	646	BGS
9264	645	BGS
9265	645	BGS
9266	645	BGS
9267	647	BGS
9268	645	BGS
9274	366	BGS
9286	145	BGS
9287	843	BGS
9269	799	BGS
9270	839	BGS
9271	838	BGS
9272	721	BGS
9273	452	BGS
9275	47	BGS
9276	527	BGS
9277	736	BGS
9279	358	BGS
9280	721	BGS
9282	325	BGS
9283	325	BGS
9284	325	BGS
9285	325	BGS
9288	423	BGS
9289	424	BGS
9290	303	BGS
9291	415	BGS
9296	227	BGS
9297	222	BGS

Art.		BGS/ KM
9298	371	BGS
9299	401	BGS
9300	138	KM
9302	776	BGS
9303	768	BGS
9306	864	BGS
9307	690	BGS
9309	633	BGS
9308	609	BGS
9310	453	BGS
9311	766	BGS
9312	766	BGS
9313	868	BGS
9314	231	BGS
9315	230	BGS
9316	230	BGS
9317	230	BGS
9318	60	KM
9319	709	BGS
9320	387	BGS
9321	263	BGS
9322	263	BGS
9323	527	BGS
9324	610	BGS
9326	642	BGS
9327	778	BGS
9328	178	BGS
9328-LEER	02_19	BGS
9329	756	BGS
9330	266	BGS
9331	555	BGS
9332	722	BGS
9333	581	BGS
9334	785	BGS
9336	129	BGS
9338	124	BGS
9339	527	BGS
9341	169	BGS
9342	69	BGS
9343	69	BGS
9344	69	BGS
9346	483	BGS
9346-1	483	BGS
9347	484	BGS
9348	QF7	BGS
9349	QF7	BGS
9350	QF6	BGS
9351	QF6	BGS
9352	QF6	BGS
9353	QF7	BGS
9354	QF7	BGS
9355	QF1	BGS
9356	QF2	BGS
9357	QF2	BGS
9358	QF3	BGS
9359	QF2	BGS
9360	QF2	BGS
9361	QF3	BGS
9362	QF3	BGS
9363	QF2	BGS
9364	QF6	BGS

Art.		BGS/ KM
9365	QF7	BGS
9366	78	BGS
9367	681	BGS
9368	378	BGS
9371	115	BGS
9372	551	BGS
9373	234	BGS
9373-12	234	BGS
9373-13	234	BGS
9373-14	234	BGS
9373-16	234	BGS
9374	336	BGS
9375	338	BGS
9376	618	BGS
9377	423	BGS
9378	662	BGS
9379	641	BGS
9380	905	BGS
9381	905	BGS
9382	840	BGS
9383	840	BGS
9384	182	BGS
9385	126	BGS
9386	QF8	BGS
9387	656	BGS
9388	564	BGS
9389	564	BGS
9390	773	BGS
9391	787	BGS
9392	489	BGS
9393	416	BGS
9393-1	416	BGS
9394	670	BGS
9395	480	BGS
9396	02_18	KM
9397	347	BGS
9401	07_18	BGS
9402	04_18	BGS
9403	02_19	BGS
9404	883	BGS
9405	883	BGS
9406	887	BGS
9408	209	BGS
9409	04_18	BGS
9409-1	04_18	BGS
9409-2	04_18	BGS
9409-3	04_18	BGS
9409-4	04_18	BGS
9409-5	04_18	BGS
9409-6	04_18	BGS
9411	575	BGS
9412	485	BGS
9413	400	BGS
9414	508	BGS
9415	275	BGS
9416	275	BGS
9417	417	BGS
9418	712	BGS
9419	585	BGS
9420	516	BGS
9421	743	BGS

Art.		BGS/ KM
9422	633	BGS
9423	552	BGS
9424	790	BGS
9425	835	BGS
9425-5	835	BGS
9425-10	835	BGS
9425-15	835	BGS
9425-20	835	BGS
9425-25	835	BGS
9425-30	835	BGS
9425-35	835	BGS
9425-40	835	BGS
9425-45	835	BGS
9426	834	BGS
9427	240	BGS
9427-1	240	BGS
9427-3	01_19	BGS
9428	240	BGS
9428-1	240	BGS
9428-3	01_19	BGS
9429	240	BGS
9429-1	240	BGS
9429-3	01_19	BGS
9430	240	BGS
9430-1	240	BGS
9430-3	01_19	BGS
9431	240	BGS
9431-1	240	BGS
9431-3	01_19	BGS
9432	240	BGS
9432-1	240	BGS
9432-3	01_19	BGS
9433	240	BGS
9433-1	240	BGS
9433-3	01_19	BGS
9434	240	BGS
9434-1	240	BGS
9434-3	01_19	BGS
9435	240	BGS
9435-1	240	BGS
9435-3	01_19	BGS
9436	240	BGS
9436-1	240	BGS
9436-3	01_19	BGS
9437	240	BGS
9437-1	240	BGS
9437-3	01_19	BGS
9438	240	BGS
9438-1	240	BGS
9438-3	01_19	BGS
9439	04_18	BGS
9440	488	BGS
9441	04_18	BGS
9442	641	BGS
9444	547	BGS
9445	464	BGS
9446	542	BGS
9447	545	BGS
9449	04_18	BGS
9450	262	BGS
9451	507	BGS

Art.		BGS/ KM
9452	507	BGS
9453	725	BGS
9454	04_18	BGS
9455	743	BGS
9456	332	BGS
9457	602	BGS
9458	46	BGS
9459	200	BGS
9460	420	BGS
9461	617	BGS
9462	04_18	BGS
9463	04_18	BGS
9464	722	BGS
9465	462	BGS
9466	QF6	BGS
9467	QF6	BGS
9468	02_18	BGS
9469	02_18	BGS
9470	504	BGS
9471	843	BGS
9472	599	BGS
9473	302	BGS
9474	780	BGS
9475	02_18	BGS
9476	878	BGS
9479	778	BGS
9480	888	BGS
9490	04_18	BGS
9491	04_18	BGS
9492	712	BGS
9493	712	BGS
9495	04_18	BGS
9496	10_18	BGS
9497	23	BGS
9498	02_18	BGS
9499	124	BGS
9500	834	BGS
9501	02_18	BGS
9502	594	BGS
9504	04_18	KM
9505	02_18	KM
9519	820	BGS
9520	368	BGS
9523	22	BGS
9524	724	BGS
9525	04_18	BGS
9527	487	BGS
9528	04_18	BGS
9529	04_18	BGS
9530	04_18	BGS
9532	04_18	BGS
9533	10_18	BGS
9533-1	10_18	BGS
9533-2	10_18	BGS
9535	04_18	BGS
9537	02_18	BGS
9538	23	BGS
9539	375	BGS
9540	613	BGS
9541	01_19	BGS
9542	01_19	BGS

Art.		BGS/ KM
9543	01_19	BGS
9544	01_19	BGS
9545	01_19	BGS
9546	02_18	BGS
9547	04_18	BGS
9548	01_19	KM
9550	71	BGS
9551	144	BGS
9553	04_18	BGS
9555	04_18	BGS
9556	02_18	BGS
9557	02_18	BGS
9558	02_18	BGS
9559	02_18	BGS
9560	10_18	BGS
9561	10_18	KM
9565	01_19	BGS
9569	04_18	BGS
9570	04_18	BGS
9571	04_18	BGS
9572	04_18	BGS
9573	02_18	BGS
9576	04_18	KM
9577	04_18	KM
9578	04_18	BGS
9579	02_19	BGS
9580	04_18	BGS
9582	10_18	BGS
9583	04_19	BGS
9584	04_18	BGS
9585	04_18	BGS
9586	04_18	BGS
9587	04_18	BGS
9588	04_18	BGS
9589	04_18	BGS
9591	04_18	BGS
9592	04_18	BGS
9593	02_18	BGS
9594	02_18	BGS
9595	390	BGS
9596	04_18	BGS
9597	577	BGS
9598	274	BGS
9599	274	BGS
9601	04_18	BGS
9603	10_18	BGS
9602	04_19	BGS
9605	07_18	BGS
9606	07_18	BGS
9610	897	BGS
9611	897	BGS
9612	897	BGS
9613	897	BGS
9614	07_18	BGS
9615	07_18	BGS
9616	07_18	BGS
9617	07_18	BGS
9620	898	BGS
9621	07_18	BGS
9622	10_18	BGS
9623	10_18	BGS

Art.		BGS/ KM
9624	07_18	BGS
9625	07_18	BGS
9626	07_18	BGS
9627	02_19	BGS
9628	02_19	BGS
9629	07_18	BGS
9631	07_18	BGS
9632	07_18	BGS
9633	10_18	BGS
9634	10_18	BGS
9635	12_18	BGS
9636	12_18	BGS
9637	07_18	BGS
9638	07_18	BGS
9639	07_18	BGS
9640	10_18	BGS
9641	10_18	BGS
9642	07_18	BGS
9647	10_18	BGS
9648	10_18	BGS
9649	10_18	BGS
9651	07_18	KM
9652	07_18	BGS
9653	07_18	BGS
9655	10_18	BGS
9656	07_18	BGS
9657	07_18	BGS
9660	895	BGS
9661	n/a	BGS
9665	04_19	BGS
9666	04_19	BGS
9667	07_18	KM
9668	07_18	KM
9669	02_19	BGS
9670	10_18	BGS
9671	10_18	BGS
9672	10_18	KM
9673	10_18	BGS
9683	12_18	BGS
9684	12_18	BGS
9685	10_18	BGS
9686	12_18	BGS
9687	12_18	BGS
9688	12_18	BGS
9689	12_18	BGS
9690	12_18	BGS
9691	01_19	BGS
9692	12_18	BGS
9693	12_18	BGS
9694	12_18	BGS
9695	12_18	BGS
9697	12_18	BGS
9699	12_18	BGS
9700	268	BGS
9704	769	BGS
9710	n/a	KM
9711	138	KM
9737	10_18	BGS
9738	12_18	BGS
9739	12_18	BGS
9746	04_18	BGS

Art.		BGS/ KM
9747	04_18	BGS
9748	04_18	BGS
9749	04_18	BGS
9753	10_18	BGS
9754	12_18	BGS
9758	04_19	BGS
9759	02_19	BGS
9764	04_19	KM
9765	12_18	BGS
9766	02_19	BGS
9767	10_18	BGS
9768	02_19	BGS
9769	12_18	BGS
9771	02_19	BGS
9775	768	BGS
9777	12_18	BGS
9778	04_19	BGS
9779	12_18	BGS
9779-10	01_19	BGS
9779-12	01_19	BGS
9779-14	01_19	BGS
9779-16	01_19	BGS
9779-18	01_19	BGS
9779-20	01_19	BGS
9779-22	01_19	BGS
9779-24	01_19	BGS
9781	12_18	KM
9782	04_19	BGS
9783	04_19	KM
9789	10_18	KM
9780	01_19	BGS
9786	04_19	BGS
9787	04_19	KM
9791	01_19	BGS
9792	04_19	BGS
9793	02_19	KM
9794	10_18	KM
9795	04_19	BGS
9796	12_18	BGS
9798	01_19	KM
9799	01_19	BGS
9801	01_19	BGS
9803	02_19	BGS
9805	04_19	BGS
9808	02_19	BGS
9811	01_19	BGS
9812	01_19	BGS
9813	01_19	BGS
9815	04_19	BGS
9816	04_19	BGS
9826	02_19	BGS
9827	02_19	BGS
9831	02_19	BGS
9832	02_19	BGS
9833	02_19	BGS
9835	04_19	BGS
9838	04_19	BGS
9842	04_19	BGS
9844	04_19	BGS
9845	04_19	BGS
9846	04_19	BGS

Art.		BGS/ KM
9847	01_19	BGS
9856	01_19	BGS
9857	01_19	BGS
9858	02_19	BGS
9859	04_19	BGS
9860	04_19	BGS
9862	04_19	BGS
9863	04_19	BGS
9864	04_19	BGS
9865	02_19	BGS
9866	04_19	BGS
9867	04_19	BGS
9868	04_19	BGS
9872	915	BGS
9873	04_19	BGS
9874	04_19	BGS
9876	04_19	BGS
9877	04_19	BGS
9878	02_19	BGS
9879	04_19	BGS
9880	04_19	BGS
9880-REP	04_19	BGS
9898	918	BGS
9899	918	BGS
9901	n/a	BGS
9902	n/a	BGS
9910	807	BGS
9916	430	BGS
9919	432	BGS
9919-LEER	n/a	BGS
9919-REP01	432	BGS
9919-REP02	432	BGS
9919-REP03	432	BGS
9920	105	KM
9921	105	KM
9923	432	BGS
9924	432	BGS
9925	281	BGS
9926	810	BGS
9927	02_19	BGS
9931	429	BGS
9933	04_19	KM
9935	43	KM
9936	43	KM
9937	228	BGS
9938	757	BGS
9939	757	BGS
9940	104	KM
9941	104	KM
9942	915	BGS
9943	757	BGS
9944	757	BGS
9945	378	BGS
9946	758	BGS
9947	900	BGS
9948	431	BGS
9949	900	BGS
9950	900	BGS
9951	900	BGS
9953	900	BGS
9954	900	BGS

Art.		BGS/ KM
9956	900	BGS
9957	900	BGS
9959	151	KM
9961	151	KM
9965	585	BGS
9965-1	585	BGS
9966	585	BGS
9967	584	BGS
9974	583	BGS
9976	474	BGS
9977	534	BGS
9978	782	BGS
9979	779	BGS
9980	780	BGS
9981	779	BGS
9982	780	BGS
9983	757	BGS
9984	757	BGS
9985	767	BGS
9986	788	BGS
9987	781	BGS
9988	757	BGS
9989	810	BGS
9990	784	BGS
9991	783	BGS
9991-2	783	BGS
9992	784	BGS
9992-1	783	BGS
9992-2	784	BGS
9992-109	784	BGS
9992-110	784	BGS
9992-111	784	BGS
9992-112	784	BGS
9992-113	784	BGS
9992-114	784	BGS
9992-115	784	BGS
9992-116	784	BGS
9992-118	784	BGS
9994	779	BGS
9997	780	BGS
10101	QF3	BGS
10102	QF3	BGS
10104	QF3	BGS
10105	QF3	BGS
10106	QF3	BGS
10107	QF3	BGS
10108	QF3	BGS
10109	QF3	BGS
10110	QF3	BGS
10111	QF3	BGS
10112	QF3	BGS
10113	QF3	BGS
10114	QF3	BGS
10154	QF3	BGS
10155	QF3	BGS
10156	QF3	BGS
10157	QF3	BGS
10158	QF3	BGS
10159	QF3	BGS
10160	QF3	BGS
10161	QF3	BGS

Art.		BGS/ KM
10162	QF3	BGS
10163	QF3	BGS
10208	QF3	BGS
10209	QF3	BGS
10210	QF3	BGS
10211	QF3	BGS
10212	QF3	BGS
10213	QF3	BGS
10214	QF3	BGS
10215	QF3	BGS
10216	QF3	BGS
10217	QF3	BGS
10218	QF3	BGS
10219	QF3	BGS
10220	QF3	BGS
10221	QF3	BGS
10222	QF3	BGS
10224	QF3	BGS
10227	QF3	BGS
10230	QF3	BGS
10232	QF3	BGS
10254	QF3	BGS
10255	QF3	BGS
10256	QF3	BGS
10257	QF3	BGS
10258	QF3	BGS
10259	QF3	BGS
10268	QF3	BGS
10270	QF3	BGS
10271	QF3	BGS
10272	QF3	BGS
10310	QF3	BGS
10311	QF3	BGS
10312	QF3	BGS
10313	QF3	BGS
10314	QF3	BGS
10315	QF3	BGS
10316	QF3	BGS
10317	QF3	BGS
10318	QF3	BGS
10319	QF3	BGS
10350	QF3	BGS
10351	QF3	BGS
10352	QF3	BGS
10353	QF3	BGS
10354	QF3	BGS
10355	QF3	BGS
10408	12_18	BGS
10410	12_18	BGS
10411	12_18	BGS
10412	12_18	BGS
10413	12_18	BGS
10414	12_18	BGS
10503	QF1	BGS
10504	QF1	BGS
10505	QF1	BGS
10506	QF1	BGS
10507	QF1	BGS
10508	QF1	BGS
10509	QF1	BGS
10510	QF1	BGS

Art.		BGS/KM
10511	QF1	BGS
10512	QF1	BGS
10513	QF1	BGS
10514	QF1	BGS
10528	QF1	BGS
10530	QF1	BGS
10531	QF1	BGS
10532	QF1	BGS
10533	QF1	BGS
10534	QF1	BGS
10535	QF1	BGS
10536	QF1	BGS
10537	QF1	BGS
10538	QF1	BGS
10539	QF1	BGS
10550	QF1	BGS
10551	QF1	BGS
10552	QF1	BGS
10553	QF1	BGS
10554	QF1	BGS
10555	QF1	BGS
10556	QF1	BGS
10557	QF1	BGS
10558	QF1	BGS
10559	QF1	BGS
10560	QF1	BGS
10561	QF1	BGS
10562	QF1	BGS
10564	QF1	BGS
10566	QF1	BGS
10567	QF1	BGS
10568	QF1	BGS
10570	QF1	BGS
10572	QF1	BGS
10610	QF1	BGS
10611	QF1	BGS
10612	QF1	BGS
10613	QF1	BGS
10614	QF1	BGS
10615	QF1	BGS
10616	QF1	BGS
10617	QF1	BGS
10618	QF1	BGS
10619	QF1	BGS
10625	QF2	BGS
10626	QF2	BGS
10627	QF1	BGS
10628	QF2	BGS
10629	QF2	BGS
10630	QF2	BGS
10631	QF2	BGS
10632	QF2	BGS
10633	QF2	BGS
10634	QF2	BGS
10635	QF2	BGS
10636	QF2	BGS
10637	QF2	BGS
10638	QF2	BGS
10639	QF2	BGS
10640	QF2	BGS
10641	QF2	BGS

Art.		BGS/KM
10642	QF2	BGS
10644	QF2	BGS
10645	QF2	BGS
10646	QF2	BGS
10647	QF2	BGS
10648	QF2	BGS
10649	QF2	BGS
10650	QF1	BGS
10651	QF1	BGS
10652	QF1	BGS
10653	QF1	BGS
10654	QF1	BGS
10655	QF1	BGS
10656	QF1	BGS
10657	QF1	BGS
10658	QF1	BGS
10659	QF1	BGS
10662	QF2	BGS
10663	QF2	BGS
10664	QF2	BGS
10670	QF1	BGS
10671	QF1	BGS
10672	QF1	BGS
10673	QF1	BGS
10674	QF1	BGS
10680	QF2	BGS
10681	QF2	BGS
10682	QF2	BGS
10683	QF2	BGS
10684	QF2	BGS
10685	QF2	BGS
10686	QF2	BGS
10687	QF2	BGS
10688	QF2	BGS
10689	QF2	BGS
10772	QF2	BGS
10773	QF2	BGS
10774	QF2	BGS
10775	QF2	BGS
10776	QF2	BGS
10777	QF2	BGS
10778	QF2	BGS
10779	QF2	BGS
10780	QF2	BGS
10781	QF2	BGS
10782	QF2	BGS
10783	QF2	BGS
10784	QF2	BGS
10870	04_18	BGS
10871	04_18	BGS
10872	04_18	BGS
10873	04_18	BGS
10874	04_18	BGS
10875	04_18	BGS
10876	04_18	BGS
10877	04_18	BGS
10878	04_18	BGS
10879	04_18	BGS
10880	04_18	BGS
10881	04_18	BGS
11000	480	BGS

Art.		BGS/KM
11006	479	BGS
11007	479	BGS
11008	479	BGS
11009	479	BGS
11010	479	BGS
11011	479	BGS
11012	479	BGS
11013	479	BGS
11014	479	BGS
11015	479	BGS
11016	479	BGS
11017	479	BGS
11018	479	BGS
11019	479	BGS
11020	479	BGS
14105	875	BGS
14110	875	BGS
14115	878	BGS
14120	876	BGS
14125	12_18	BGS
14126	876	BGS
14127	877	BGS
14130	881	BGS
14135	882	BGS
14136	10_18	BGS
14140	12_18	BGS
14145	878	BGS
15007	15	KM
15008	15	KM
15105	10	KM
15110	11	KM
15111	12	KM
15112	11	KM
15113	12	KM
15123	16	KM
15125	16	KM
15216	4	KM
15216-1	n/a	BGS
15217	02_18	KM
15501	106	BGS
15501-2	875	BGS
15501-LEER	n/a	BGS
18087	112	KM
19500	49	KM
20100	179	BGS
20101	22	KM
20102	10	KM
20122	10_18	KM
20131	01_19	KM
20138	20	KM
20210	18	KM
20801	27	KM
20802	24	KM
20804	25	KM
20805	25	KM
20806	97	KM
20810	23	KM
20816	25	KM
20820	25	KM
20823	26	KM
20831	26	KM

Art.		BGS/KM
22474	12_18	BGS
22475	12_18	BGS
22476	12_18	BGS
22477	12_18	BGS
22478	12_18	BGS
22479	12_18	BGS
22480	12_18	BGS
22481	12_18	BGS
22482	12_18	BGS
22483	12_18	BGS
22484	12_18	BGS
22485	12_18	BGS
22486	12_18	BGS
22908	12_18	BGS
22909	12_18	BGS
22910	12_18	BGS
22911	12_18	BGS
22912	12_18	BGS
22913	12_18	BGS
22914	12_18	BGS
22915	12_18	BGS
22916	12_18	BGS
22917	12_18	BGS
22918	12_18	BGS
22919	12_18	BGS
22921	12_18	BGS
22922	12_18	BGS
22924	12_18	BGS
22927	12_18	BGS
22930	12_18	BGS
22932	12_18	BGS
25103	187	BGS
25104	187	BGS
25105	187	BGS
25106	187	BGS
25107	187	BGS
25108	187	BGS
25140	196	BGS
25150	294	BGS
25151	422	BGS
26404	12_18	BGS
26405	12_18	BGS
26406	12_18	BGS
26407	12_18	BGS
26408	12_18	BGS
26430	12_18	BGS
26431	12_18	BGS
30000	79	KM
30001	78	KM
30002	78	KM
30003	80	KM
30004	79	KM
30005	79	KM
30006	78	KM
30007	80	KM
30030	77	KM
30035	75	KM
30100	302	BGS
30101	302	BGS
30106	QF11	BGS
30107	QF11	BGS

Art.		BGS/KM
30108	QF11	BGS
30109	QF11	BGS
30110	QF11	BGS
30111	QF11	BGS
30112	QF11	BGS
30113	QF11	BGS
30114	QF11	BGS
30115	QF11	BGS
30116	QF11	BGS
30117	QF11	BGS
30118	QF11	BGS
30119	QF11	BGS
30120	QF11	BGS
30121	QF11	BGS
30122	QF11	BGS
30123	QF11	BGS
30124	QF11	BGS
30125	QF11	BGS
30126	QF11	BGS
30127	QF11	BGS
30128	QF11	BGS
30129	QF11	BGS
30130	QF11	BGS
30132	QF11	BGS
30134	04_18	BGS
30136	04_18	BGS
30141	04_18	BGS
30146	04_18	BGS
30155	04_18	BGS
30160	04_18	BGS
30188	QF12	BGS
30189	QF12	BGS
30190	QF12	BGS
30191	QF12	BGS
30192	QF12	BGS
30193	QF12	BGS
30194	QF12	BGS
30195	QF12	BGS
30196	QF12	BGS
30197	QF12	BGS
30198	QF12	BGS
30199	QF12	BGS
30200	308	BGS
30206	QF13	BGS
30208	QF13	BGS
30210	QF13	BGS
30211	QF13	BGS
30212	QF13	BGS
30213	QF13	BGS
30214	QF13	BGS
30215	QF13	BGS
30216	QF13	BGS
30217	QF13	BGS
30218	QF13	BGS
30220	QF13	BGS
30221	QF13	BGS
30223	QF13	BGS
30224	QF13	BGS
30230	QF13	BGS
30236	QF13	BGS
30246	QF13	BGS

Art.		BGS/KM
30300	310	BGS
30300-LEER	310	BGS
30301	300	BGS
30302	300	BGS
30306	308	BGS
30330	QF13	BGS
30331	QF13	BGS
30332	QF13	BGS
30333	QF13	BGS
30334	QF13	BGS
30335	QF13	BGS
30336	QF13	BGS
30337	QF13	BGS
30338	04_19	BGS
30339	04_19	BGS
30412	473	BGS
30413	473	BGS
30500	301	BGS
30501	300	BGS
30506	QF11	BGS
30507	QF11	BGS
30508	QF11	BGS
30509	QF11	BGS
30510	QF11	BGS
30511	QF11	BGS
30512	QF11	BGS
30513	QF11	BGS
30514	QF11	BGS
30515	QF11	BGS
30516	QF11	BGS
30517	QF11	BGS
30518	QF11	BGS
30519	QF11	BGS
30520	QF11	BGS
30521	QF11	BGS
30522	QF11	BGS
30523	QF11	BGS
30524	QF11	BGS
30525	QF11	BGS
30526	QF11	BGS
30527	QF11	BGS
30528	QF11	BGS
30530	QF11	BGS
30532	QF11	BGS
30552	QF11	BGS
30553	QF11	BGS
30554	QF11	BGS
30555	QF11	BGS
30556	QF11	BGS
30557	QF11	BGS
30558	QF11	BGS
30559	QF11	BGS
30560	QF11	BGS
30561	QF11	BGS
30562	QF11	BGS
30563	QF11	BGS
30564	QF11	BGS
30565	QF11	BGS
30566	QF11	BGS
30567	QF11	BGS
30568	QF11	BGS

Art.		BGS/KM
30569	QF11	BGS
30570	QF11	BGS
30571	QF11	BGS
30572	QF11	BGS
30573	07_18	BGS
30574	QF11	BGS
30577	QF11	BGS
30578	QF11	BGS
30579	QF11	BGS
30600	306	BGS
30601	306	BGS
30605	QF13	BGS
30606	QF13	BGS
30608	QF13	BGS
30610	QF13	BGS
30611	QF13	BGS
30612	QF13	BGS
30613	QF13	BGS
30614	QF13	BGS
30616	QF13	BGS
30617	QF13	BGS
30618	QF13	BGS
30620	QF13	BGS
30621	QF13	BGS
30622	QF13	BGS
30623	QF13	BGS
30624	QF13	BGS
30625	QF13	BGS
30627	QF13	BGS
30630	QF13	BGS
30631	QF13	BGS
30632	QF13	BGS
30636	QF13	BGS
30673	QF12	BGS
30675	QF12	BGS
30680	10_18	BGS
30681	10_18	BGS
30683	10_18	BGS
30685	10_18	BGS
30708	319	BGS
30709	319	BGS
30710	319	BGS
30711	319	BGS
30712	319	BGS
30713	319	BGS
30714	319	BGS
30715	319	BGS
30716	319	BGS
30717	319	BGS
30718	319	BGS
30719	319	BGS
30720	315	BGS
30721	QF13	BGS
30722	QF13	BGS
30723	QF13	BGS
30724	QF13	BGS
30725	QF13	BGS
30741	QF13	BGS
30742	QF13	BGS
30743	QF13	BGS
30744	QF13	BGS

Art.		BGS/KM
30745	QF13	BGS
30760	QF11	BGS
30761	QF11	BGS
30762	QF11	BGS
30763	QF11	BGS
30764	QF11	BGS
30775	QF11	BGS
30776	QF11	BGS
30765	QF11	BGS
30778	QF11	BGS
30779	QF11	BGS
30809	319	BGS
30812	319	BGS
30816	319	BGS
30828	318	BGS
30829	318	BGS
30830	318	BGS
30831	318	BGS
30832	318	BGS
30833	23	BGS
30833-1	23	BGS
30835	318	BGS
30836	317	BGS
30838	318	BGS
30839	318	BGS
30840	318	BGS
30841	318	BGS
30842	318	BGS
30900-LEER	n/a	BGS
30902	314	BGS
30908	319	BGS
30911	319	BGS
30914	319	BGS
30915	319	BGS
30917	319	BGS
30918	319	BGS
30950	314	BGS
32100	297	BGS
32105	309	BGS
32140	299	BGS
32150	310	BGS
32400	304	BGS
32400-LEER	304	BGS
32500	305	BGS
32801	420	BGS
32802	n/a	BGS
32805	391	BGS
32899	390	BGS
34206	QF11	BGS
34207	QF11	BGS
34208	QF11	BGS
34209	QF11	BGS
34210	QF11	BGS
34211	QF11	BGS
34212	QF11	BGS
34213	QF11	BGS
34214	QF11	BGS
34215	QF11	BGS
34216	QF11	BGS
34217	QF11	BGS
34218	QF11	BGS

Art.		BGS/ KM
34219	QF11	BGS
34221	QF11	BGS
34222	QF11	BGS
34223	QF11	BGS
34224	QF11	BGS
34225	QF11	BGS
34227	QF11	BGS
34230	QF11	BGS
34232	QF11	BGS
34234	QF11	BGS
34236	QF11	BGS
34238	QF11	BGS
34241	QF11	BGS
34246	QF11	BGS
34250	QF11	BGS
34255	QF11	BGS
34260	QF11	BGS
34265	QF11	BGS
34270	QF11	BGS
34275	QF11	BGS
34280	QF11	BGS
34285	QF11	BGS
34290	QF11	BGS
34295	QF11	BGS
35100	335	BGS
35101	336	BGS
35105	337	BGS
35124	10_18	BGS
35127	10_18	BGS
35130	10_18	BGS
35132	10_18	BGS
35134	10_18	BGS
35136	10_18	BGS
35138	10_18	BGS
35141	10_18	BGS
35146	10_18	BGS
35150	10_18	BGS
35155	10_18	BGS
35160	10_18	BGS
35165	10_18	BGS
35170	10_18	BGS
35175	10_18	BGS
35180	10_18	BGS
35318	10_18	BGS
35230	10_18	BGS
35232	10_18	BGS
35236	10_18	BGS
35241	10_18	BGS
35246	10_18	BGS
35250	10_18	BGS
35255	10_18	BGS
35260	10_18	BGS
35265	10_18	BGS
35270	10_18	BGS
35275	10_18	BGS
35280	10_18	BGS
35285	10_18	BGS
35290	10_18	BGS
35295	10_18	BGS
35320	10_18	BGS
35324	10_18	BGS

Art.		BGS/ KM
35334	10_18	BGS
35336	02_19	BGS
35807	70	KM
35808	70	KM
35812	284	BGS
35815	72	KM
35820	73	KM
35826	67	KM
35831	21	KM
35835	72	KM
35838	285	BGS
40100	826	BGS
40105	827	BGS
40106	498	BGS
40107	498	BGS
40108	131	KM
40110	827	BGS
42015	01_19	BGS
42016	01_19	BGS
42025	01_19	BGS
42026	01_19	BGS
42027	01_19	BGS
42028	01_19	BGS
42031	01_19	BGS
42032	01_19	BGS
50200	235	BGS
50210	45	KM
50235	45	KM
50240	52	KM
50300	42	KM
50305	42	KM
50310	42	KM
50315	42	KM
50335	59	KM
50340	59	KM
50350	272	BGS
50355	60	KM
50401	225	BGS
50403	225	BGS
50405	40	KM
50406	10_18	KM
50407	40	KM
50408	10_18	KM
50410	18	KM
50440	266	BGS
50500	82	KM
50505	10_18	KM
50602	259	BGS
50603	n/a	KM
50604	54	KM
50605	263	BGS
50606	260	BGS
50611	54	KM
50613	55	KM
50615	146	KM
50616	n/a	KM
50619	51	KM
50620	53	KM
50625	259	BGS
50626	259	BGS
50628	55	KM

Art.		BGS/ KM
50630	02_18	KM
50801	38	KM
50802	46	KM
50803	46	KM
50804	47	KM
50805	37	KM
50807	37	KM
50808	38	KM
50813	38	KM
50815	04_19	KM
50816	36	KM
50817	04_19	KM
50818	04_19	KM
50819	37	KM
50820	36	KM
50830	156	KM
50835	48	KM
50840	85	KM
50850	60	KM
50855	273	BGS
50860	273	BGS
50861	168	KM
50865	273	BGS
50869	57	KM
50870	57	KM
50871	57	KM
50872	57	KM
50873	57	KM
50877	57	KM
50880	02_19	KM
50885	58	KM
50888	58	KM
50903	44	KM
50908	44	KM
52104	142	KM
52106	142	KM
52109	142	KM
52138	141	KM
52302	253	BGS
52303	253	BGS
52304	253	BGS
52305	253	BGS
52308	253	BGS
52310	253	BGS
52315	253	BGS
52320	253	BGS
52326	254	BGS
52712	913	BGS
52830	141	KM
53801	168	KM
53820	56	KM
55400	402	BGS
55401	403	BGS
55410	401	BGS
55411	403	BGS
55412	04_18	KM
55415	402	BGS
59001	324	BGS
59002	324	BGS
59003	324	BGS
59004	324	BGS

Art.		BGS/ KM
59110	324	BGS
59112	324	BGS
59115	324	BGS
59255	324	BGS
59260	324	BGS
59265	324	BGS
59270	324	BGS
59505	137	KM
59804	84	KM
59810	83	KM
59811	84	KM
59812	83	KM
59813	84	KM
59815	83	KM
59816	10_18	KM
59820	02_19	KM
59824	02_19	KM
59826	02_19	KM
59830	02_19	KM
59835	02_19	KM
60100	494	BGS
60100-1	494	BGS
60100-CE56	494	BGS
60100-CE91	494	BGS
60120	495	BGS
60150	495	BGS
60160	495	BGS
60300	120	KM
62005	603	BGS
62005-1	603	BGS
62050	640	BGS
62051	12_18	BGS
62505	679	BGS
62506	669	BGS
62604	604	BGS
62605	604	BGS
62606	605	BGS
62610	730	BGS
62614	634	BGS
62616	634	BGS
62616-2	634	BGS
62617	635	BGS
62617-14	635	BGS
62618	627	BGS
62619	636	BGS
62622	675	BGS
62623	662	BGS
62623-1	662	BGS
62625	701	BGS
62625-1	701	BGS
62626	640	BGS
62627	636	BGS
62628	663	BGS
62630	610	BGS
62630-1	610	BGS
62632	664	BGS
62633	664	BGS
62634	637	BGS
62635	603	BGS
62635-1	603	BGS
62635-2	603	BGS

Art.		BGS/ KM
62635-3	603	BGS
62636	134	KM
62637	637	BGS
62637-1	637	BGS
62640	709	BGS
62641	709	BGS
62642	710	BGS
62643	710	BGS
62644	128	KM
62645	819	BGS
62645-1	819	BGS
62646	133	KM
62650	615	BGS
62650-1	615	BGS
62650-2	615	BGS
62650-3	615	BGS
62655	614	BGS
62660	133	KM
62665	651	BGS
62666	652	BGS
62666-1	652	BGS
62670	453	BGS
62671	612	BGS
62672	637	BGS
62673	728	BGS
62674	611	BGS
62675	131	BGS
63150	841	BGS
63151	841	BGS
63215	142	KM
63221	n/a	BGS
63246	n/a	BGS
63247	02_18	BGS
63250	586	BGS
63311	500	BGS
63400	829	BGS
63401	828	BGS
63402	828	BGS
63404	499	BGS
63500	809	BGS
63502	809	BGS
63505	809	BGS
63520	830	BGS
63524	816	BGS
63525	812	BGS
63528	n/a	BGS
63535	815	BGS
63800	514	BGS
64100	550	BGS
64111	553	BGS
64200	624	BGS
64201	624	BGS
64202	624	BGS
64203	624	BGS
64204	624	BGS
64205	624	BGS
64206	624	BGS
64207	624	BGS
64208	624	BGS
65260	742	BGS
65505	327	BGS

Art.		BGS/ KM
66514	474	BGS
66515	326	BGS
66515-5	327	BGS
66515-7	327	BGS
66515-9	327	BGS
66515-10.5	327	BGS
66515-11	327	BGS
66515-14	327	BGS
66515-16	327	BGS
66520	482	BGS
66521	482	BGS
66522	482	BGS
66525	482	BGS
66550	520	BGS
66590	242	BGS
66591	242	BGS
66592	517	BGS
66601	748	BGS
66630	750	BGS
66631	749	BGS
66700	582	BGS
66700-1	582	BGS
66701	898	BGS
66101	616	BGS
66102	358	BGS
66103	754	BGS
66105	379	BGS
66107	379	BGS
66109	379	BGS
66110	379	BGS
66120	362	BGS
66150	617	BGS
66151	529	BGS
66155	748	BGS
66157	748	BGS
66200	693	BGS
66200-1	693	BGS
66202	670	BGS
66205	693	BGS
66210	695	BGS
66211	702	BGS
66215	242	BGS
66215-1	242	BGS
66250	596	BGS
66250-1	596	BGS
66251	596	BGS
66255	596	BGS
66350	658	BGS
66512	473	BGS
66512-1	473	BGS
66512-2	473	BGS
66513	474	BGS
66516	04_19	BGS
66525	530	BGS
66526	530	BGS
66527	530	BGS
66528	406	BGS
66529	851	BGS
66530	530	BGS
66530-2	530	BGS
66531	851	BGS

Art.		BGS/ KM
66534	529	BGS
66535	529	BGS
66540	405	BGS
66541	406	BGS
66701	710	BGS
66703	710	BGS
66720	711	BGS
66725	711	BGS
67100	67	BGS
67102	67	BGS
67150	67	BGS
67156	68	BGS
67159	68	BGS
67160	68	BGS
67161	69	BGS
67162	70	BGS
67163	70	BGS
67164	70	BGS
67165	70	BGS
67166	71	BGS
67200	568	BGS
67201	568	BGS
67202	568	BGS
67203	497	BGS
67210	461	BGS
67210-1	461	BGS
67213	522	BGS
67214	522	BGS
67215	522	BGS
67216	522	BGS
67218	522	BGS
67220	125	BGS
67230	461	BGS
67240	812	BGS
67241	812	BGS
67242	812	BGS
67300	n/a	KM
67300-9	115	KM
67300-2	115	KM
67300-3	115	KM
67301	535	BGS
67301-1	535	BGS
67301-2	535	BGS
67301-3	535	BGS
67302	535	BGS
67302-1	535	BGS
67302-M10	535	BGS
67302-M12	535	BGS
67302-M14	535	BGS
67302-M16	535	BGS
67305	115	KM
67307	134	KM
67308	20	KM
67309	481	BGS
67310	115	KM
67801	141	KM
67850	168	KM
68000	398	BGS
68000-1	398	BGS
68000-2	398	BGS
68000-60	398	BGS

Art.		BGS/ KM
68000-120	398	BGS
68000-160	398	BGS
68010	423	BGS
68012	423	BGS
68310	689	BGS
68340	742	BGS
68341	711	BGS
68345	609	BGS
68346	731	BGS
69500	565	BGS
69505	565	BGS
69510	591	BGS
75109	01_19	BGS
75110	385	BGS
75111	385	BGS
75112	385	BGS
75113	385	BGS
75120	277	BGS
75200	385	BGS
75201	385	BGS
75205	385	BGS
75206	99	KM
75207	99	KM
75208	99	KM
75209	99	KM
75210	99	KM
75810	164	KM
75812	02_18	KM
75820	96	KM
75825	96	KM
75830	89	KM
75835	93	KM
75840	04_18	KM
75845	88	KM
75847	89	KM
75848	89	KM
75849	89	KM
78950	909	BGS
79901	02_18	KM
79903	02_18	KM
79905	02_18	KM
79907	02_18	KM
79909	02_18	KM
79911	02_18	KM
79913	02_18	KM
79915	02_18	KM
79919	02_18	KM
80330	159	KM
80332	160	KM
80336	160	KM
80338	160	KM
80340	175	KM
80550	10_18	KM
80601	905	BGS
80602	906	BGS
80603	906	BGS
80603-1	906	BGS
80604	909	BGS
80605	909	BGS
80606	908	BGS
80607	908	BGS

Art.		BGS/ KM
80608	911	BGS
80609	912	BGS
80610	912	BGS
80612	910	BGS
80613	911	BGS
80614	907	BGS
80615	907	BGS
80616	910	BGS
80617	12_18	BGS
80650	162	KM
80652	162	KM
80655	162	KM
80657	162	KM
80663	161	KM
80664	161	KM
80701	10_18	KM
80703	10_18	KM
80711	10_18	KM
80713	10_18	KM
80724	169	KM
80725	194	KM
80727	194	KM
80751	144	KM
80752	144	KM
80753	144	KM
80754	144	KM
80756	811	BGS
80757	876	BGS
80760	145	KM
80761	108	KM
80762	108	KM
80770	186	KM
80772	186	KM
80773	186	KM
80774	186	KM
80775	186	KM
80776	186	KM
80777	186	KM
80778	186	KM
80779	186	KM
80781	181	KM
80782	156	KM
80783	181	KM
80784	181	KM
80785	181	KM
80787	181	KM
80802	169	KM
80804	170	KM
80805	170	KM
80807	170	KM
80815	47	KM
80817	47	KM
80819	48	KM
80823	04_18	KM
80824	04_18	KM
80825	194	KM
80836	873	BGS
80841	194	KM
80843	195	KM
80844	195	KM
80845	105	KM

Art.		BGS/ KM
80847	108	KM
80848	108	KM
80849	107	KM
80850	195	KM
80851	107	KM
80852	107	KM
80853	171	KM
80854	171	KM
80855	193	KM
80859	878	BGS
80860	152	KM
80861	152	KM
80862	154	KM
80863	152	KM
80864	172	KM
80865	152	KM
80866	155	KM
80867	155	KM
80868	154	KM
80869	155	KM
80870	173	KM
80871	189	KM
80872	189	KM
80873	187	KM
80874	874	BGS
80875	186	KM
80876	874	BGS
80877	186	KM
80878	874	BGS
80879	186	KM
80880	170	KM
80881	874	BGS
80885	173	KM
80887	151	KM
80895	175	KM
80896	172	KM
80897	172	KM
80898	173	KM
80900	n/a	KM
80902	182	KM
80904	182	KM
80906	182	KM
80908	157	KM
80910	157	KM
80912	157	KM
80913	189	KM
80915	182	KM
80916	157	KM
80920	184	KM
80921	182	KM
80923	182	KM
80925	182	KM
80927	182	KM
80930	182	KM
80932	183	KM
80934	183	KM
80934-50	183	KM
80935	183	KM
80937	183	KM
80937-25	183	KM
80939	183	KM

Art.		BGS/ KM
80940	185	KM
80941	183	KM
80942	184	KM
80943	184	KM
80944	184	KM
80945	184	KM
80946	183	KM
80947	183	KM
80948	183	KM
80949	162	KM
80950	161	KM
80951	160	KM
80953	160	KM
80954	161	KM
80955	161	KM
80956	n/a	KM
80957	161	KM
80958	145	KM
80959	160	KM
80960	146	KM
80961	192	KM
80962	144	KM
80963	192	KM
80964	145	KM
80965	192	KM
80967	192	KM
80971	192	KM
80973	192	KM
80975	192	KM
80990	192	KM
80992	192	KM
80993	192	KM
80994	192	KM
80995	192	KM
80996	192	KM
80997	192	KM
80998	192	KM
80999	192	KM
81000	192	KM
81660	12_18	KM
81662	12_18	KM
81665	12_18	KM
81669	175	KM
81728	264	BGS
81735	264	BGS
81970	161	KM
85030	179	KM
85040	179	KM
85050	179	KM
85130	179	KM
85140	179	KM
85150	179	KM
85160	179	KM
85164	179	KM
85168	179	KM
85200	165	KM
85200-1	165	KM
85201	165	KM
85205	165	KM
85210	190	KM
85213	165	KM

Art.		BGS/ KM
85220	876	BGS
85301	769	BGS
85305	771	BGS
85305-1	771	BGS
85314	768	BGS
85316	771	BGS
85317	770	BGS
85319	770	BGS
85320	772	BGS
85321	770	BGS
85322	769	BGS
85323	02_18	BGS
85325	772	BGS
85412	771	BGS
85502	149	KM
85505	149	KM
85510	150	KM
85512	150	KM
85516	150	KM
85817	180	KM
85518	150	KM
85801	166	KM
85803	173	KM
85806	180	KM
85808	180	KM
85809	180	KM
85810	157	KM
85811	43	KM
85812	157	KM
85813	53	KM
85814	82	KM
85815	44	KM
85816	55	KM
85818	177	KM
85819	178	KM
85820	53	KM
85821	53	KM
85853	166	KM
85860	174	KM
85862	174	KM
85865	02_18	KM
86674	51	KM
86676	51	KM
86678	51	KM
86680	n/a	KM
88110	10_18	KM
88112	10_18	KM
88114	10_18	KM
88116	10_18	KM
88118	10_18	KM
88130	190	KM
88132	196	KM
88134	197	KM
88136	195	KM
88138	197	KM
88140	196	KM
88142	89	KM
88144	197	KM
88146	201	KM
88148	10_18	KM
88150	198	KM

Art.		BGS/ KM
88152	198	KM
88154	199	KM
88156	201	KM
88158	200	KM
88160	200	KM
88162	200	KM
88164	191	KM
88166	201	KM
88168	201	KM
88170	202	KM
88174	202	KM
88176	200	KM
88178	10_18	KM
88180	196	KM
88181	185	KM
88182	193	KM
88183	04_18	KM
88184	07_18	KM
88186	07_18	KM
88188	10_18	KM
88190	02_19	KM
88195	187	KM
88230	157	KM
88232	157	KM
89900	n/a	BGS
89901	n/a	BGS
89902	n/a	BGS
89903	n/a	BGS
89905	n/a	BGS
89906	n/a	BGS
89917	n/a	BGS
89920	n/a	BGS
89921	n/a	BGS
89927	n/a	BGS
89955	02_19	BGS
89956	02_19	BGS
89957	02_19	BGS
89958	02_19	BGS
89959	02_19	BGS
89960	07_18	KM
89961	07_18	KM
89962	07_18	BGS
90012	07_18	BGS
90013	07_18	BGS
90014	07_18	BGS
90015	07_18	BGS
90016	07_18	BGS
90017	07_18	BGS
90018	07_18	BGS
90019	07_18	BGS
90022	12_18	BGS
90023	12_18	BGS
90024	12_18	BGS
90025	12_18	BGS
90026	12_18	BGS
90027	12_18	BGS
90028	12_18	BGS
90032	12_18	BGS
90033	12_18	BGS
90034	12_18	BGS
90035	12_18	BGS

Art.		BGS/ KM
90036	12_18	BGS
90037	12_18	BGS
90038	12_18	BGS
90042	12_18	BGS
90043	12_18	BGS
90044	12_18	BGS
90045	12_18	BGS
90046	12_18	BGS
90047	12_18	BGS
90048	12_18	BGS
90052	12_18	BGS
90053	12_18	BGS
90054	12_18	BGS
90055	12_18	BGS
90056	12_18	BGS
90057	12_18	BGS
90058	12_18	BGS
90060	12_18	BGS
90061	12_18	BGS
90062	12_18	BGS
90063	12_18	BGS
90064	12_18	BGS
90065	12_18	BGS
90066	12_18	BGS
90067	12_18	BGS
90068	12_18	BGS
90069	12_18	BGS
90070	12_18	BGS
90071	12_18	BGS
90072	12_18	BGS
90073	12_18	BGS
90074	12_18	BGS
90075	12_18	BGS
90076	12_18	BGS
90077	12_18	BGS
90078	12_18	BGS
90079	12_18	BGS
90330	94	KM
90380	12_18	KM
90381	12_18	KM
90382	12_18	KM
90383	12_18	KM
90457	02_18	KM
90865	118	KM
91036	126	KM
91115	110	KM
91126	111	KM
91530	114	KM
91531	114	KM
91532	114	KM
91533	114	KM
91534	114	KM
91656	01_19	KM
91931	01_19	KM
92025	04_18	KM
93057	04_19	KM
93625	151	KM
95100	17	KM
95207	17	KM
97710	33	KM
97729	32	KM

Art.		BGS/ KM
97743	33	KM
98007	132	KM
98098	132	KM
98152	02_18	KM
98253	117	KM
98297	135	KM
98349	135	KM
98443	129	KM
98467	118	KM
98736	118	KM
99135	141	KM
99302	02_18	KM
99910	142	KM
962670	132	KM
AUFKLEBER	920	BGS
AUFKLEBER2	920	BGS
BALL	916	BGS
BANNER	916	BGS
BECHER	917	BGS
BOX13	10_18	BGS
BOX16	10_18	BGS
BOX26	04_19	BGS
Coin	917	BGS
F1	917	BGS
FLAG1	920	BGS
FLAG2	920	BGS
FLAG3	920	BGS
FLAG4	920	BGS
FLAG5	920	BGS
FLAG6	920	BGS
HANGER-1	n/a	BGS
HANGER-2	n/a	BGS
HANGER-3	n/a	BGS
HANGER-4	n/a	BGS
HANGER-5	n/a	BGS
HANGER-6	n/a	BGS
Kugel	917	BGS
Öffner	917	BGS
POSTER	918	BGS
TUCH	918	BGS
USB	n/a	BGS



**Are you looking for a local dealer?
Send us an Email mail@bgs-technic.de**

Sales only via specialist retailers!

Offer exclusively for commercial customers.

Explanation of pictogram: ✓ = usable with (not identical)

All images, texts and graphics Copyright© BGS technic KG; further use only with written consent.

BGS technic®, Kraftmann® & ProTorque® are registered trademarks of BGS technic KG.

XZN®, Ribe® and Torx® are registered trademarks of the respective trademark holders.

BGS "T-Profile is compatible with Torx®. All item information, in particular configuration and layout, can change unannounced in the course of continuous development and is non-binding.

Please refer to our internet site www.bgstechnic.com for the current version of each article.

Contact: BGS technic KG, Postfach 1450, 42907 Wermelskirchen;

HR Köln HRA 26256, Registered office: Wermelskirchen