

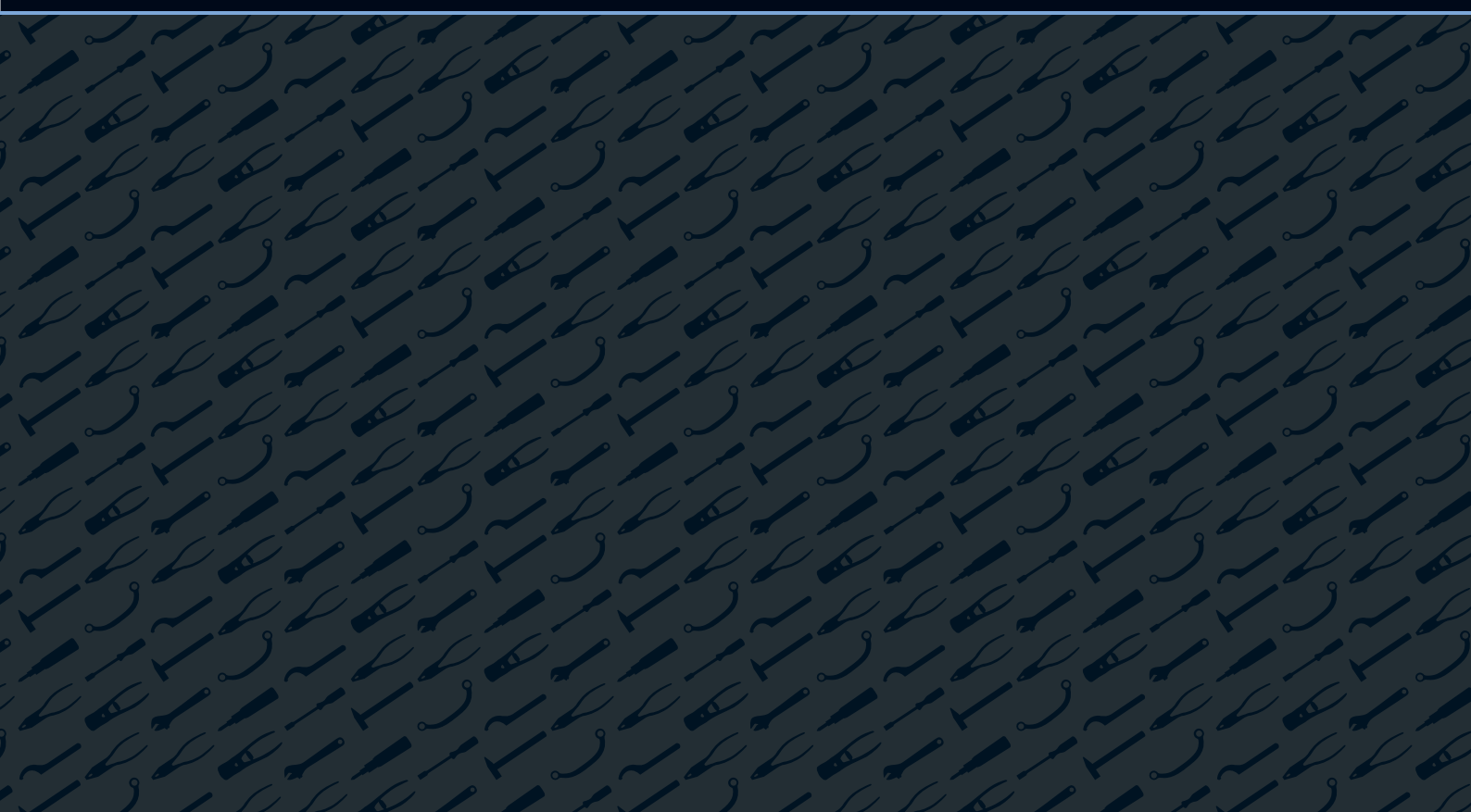

Schraubendreher

Screwdrivers



Schraubendreher Screwdrivers

2-Komponenten-Schraubendreher

- für höchste Ansprüche bei Drehmomentübertragung und ermüdungsfreiem Schrauben
- Klingen aus hochwertigem Molybdän-Vanadium- bzw. Chrom-Vanadium-Stahl, verchromt mit schwarzer Spitze
- ergonomisch geformter 2-K-Griff in modernem Design aus PP/TPE-Material mit Aufhängeloch.
- der Griff ist schlagzäh und beständig gegen handelsübliche Laugen, Lösungsmittel und Säuren.
- die Einsatzfähigkeit ist in Temperaturbereichen zwischen -30° und +80° gewährleistet.

Dual compound handle screwdrivers







- for highest demands regarding torquing and anti tiring tightening.
- high quality molybdenum vanadium or chrome vanadium steel, chrome plated with black tip.
- ergonomical 2-C-handle in modern design, PP/TPE-material with hole.
- impact resistance handle.
- resistant against solvents, acids and bases temperature resistance from -30° to +80°C

3290



Schraubendreher
DIN 5265
Klinge DIN 5264

Slotted engineer's screwdriver
DIN 5265
blade DIN 5264





Artikel-Nr. Order-No.	Ident-Nr. Ident-No.	€	 mm	 mm	 mm	 mm		
3290 / 1	3290 0010 011	7,25	1,0	5,5	125	235	88	10
3290/2	3290 0020 011	8,65	1,2	6,5	125	235	101	10
3290/3	3290 0030 011	10,90	1,2	8,0	150	270	143	10
3290/4	3290 0040 011	13,00	1,6	10,0	200	320	214	10
3290/5	3290 0050 011	14,40	2,0	12,0	200	320	249	10
3290/6	3290 0060 011	15,90	2,5	14,0	300	420	363	10

3294



Schraubendreher Philips
DIN 5265
Klinge DIN 5264

Screwdriver Philips
DIN 5265
blade DIN 5264





Artikel-Nr. Order-No.	Ident-Nr. Ident-No.	€		 mm	 mm		
3294/0	3294 0000 011	5,85	0	60	150	42	10
3294/1	3294 0010 011	7,25	1	80	180	66	10
3294/2	3294 0020 011	8,80	2	100	210	96	10
3294/3	3294 0030 011	12,45	3	150	270	164	10

3296



Schraubendreher Pozidriv
DIN 5265
Klinge DIN 5264





Screwdriver Pozidriv
DIN 5265
blade DIN 5264

Artikel-Nr. Order-No.	Ident-Nr. Ident-No.	€		 mm	 mm		
3296/0	3296 0000 011	6,70	0	60	150	42	10
3296/1	3296 0010 011	8,20	1	80	180	66	10
3296/2	3296 0020 011	9,80	2	100	210	96	10
3296/3	3296 0030 011	13,70	3	150	270	164	10



TX-Schraubendreher 

TX screwdriver 

Artikel-Nr. Order-No.	Ident-Nr. Ident-No.	€					
3297/6	3297 0060 011	7,90	TX 6	70	160	40	10
3297/7	3297 0070 011	7,90	TX 7	70	160	40	10
3297/8	3297 0080 011	7,90	TX 8	70	160	40	10
3297/9	3297 0090 011	7,90	TX 9	70	160	40	10
3297/10	3297 0100 011	8,50	TX 10	80	180	53	10
3297/15	3297 0150 011	8,90	TX 15	80	180	56	10
3297/20	3297 0200 011	9,20	TX 20	90	190	60	10
3297/25	3297 0250 011	9,45	TX 25	90	190	64	10
3297/27	3297 0270 011	10,50	TX 27	110	220	92	5
3297/30	3297 0300 011	11,00	TX 30	110	220	98	5
3297/40	3297 0400 011	13,00	TX 40	120	240	134	5
3297/45	3297 0450 011	14,50	TX 45	240	120	154	5

3297







Kugelkopf-Schraubendreher 

schraubt schwer zugänglich liegende Schrauben unter einem Winkel bis zu 25°

Ball ended hexagon screwdriver 

allows working in an angle of up to 25° at difficult to reach sites

Artikel-Nr. Order-No.	Ident-Nr. Ident-No.	€					
3299/3	3299 0030 011	6,35	3	100	190	43	10
3299/4	3299 0040 011	7,20	4	100	200	62	10
3299/5	3299 0050 011	7,80	5	100	200	71	10
3299/6	3299 0060 011	9,45	6	125	235	105	10
3299/8	3299 0080 011	10,60	8	150	260	152	10
3299/10	3299 0100 011	13,95	10	150	270	229	10

3299



Schraubendreher Screwdrivers

Profi-Werkstatt-Schraubendreher

- Klingen aus Molybdän-Vanadium- bzw. Chrom-Vanadium-Stahl und schwarzer Spitze
- ergonomisch geformter, schlagfester Griff mit Aufhängeloch
- Griffmaterial ist beständig gegen aggressive chemische Substanzen, Temperatureinsatzbereich zwischen -30° bis +80°C

Screwdrivers „Workshop“

- made of molybdenum vanadium or chrome vanadium steel, chrome plated with black tip
- ergonomically shaped, impact-resistant handle
- handle resistant against solvents acids and bases temperature resistance from -30° to +80°C

3250



Elektriker-Schraubendreher
DIN 5265
Klinge DIN 5264

Slotted instrument screwdriver
DIN 5265
blade DIN 5264

Artikel-Nr. Order-No.	Ident-Nr. Ident-No.	€	mm	mm	mm	mm		
3250/1	32500010011	3,20	0,4	2,5	60	130	20	10
3250/2	32500020011	3,40	0,5	3,0	75	155	30	10
3250/3	32500030011	3,95	0,6	3,5	100	180	47	10
3250/4	32500040011	4,65	0,8	4,0	125	215	50	10
3250/5	32500050011	5,30	0,8	5,0	150	250	75	10

3255



Elektriker-Schraubendreher
DIN 5265
Klinge DIN 5264
mit rot transparent isolierter Klinge

Slotted instrument screwdriver
DIN 5265
blade DIN 5264
red transparent insulated blade

Artikel-Nr. Order-No.	Ident-Nr. Ident-No.	€	mm	mm	mm	mm		
3255/1	32550010011	3,65	0,4	2,5	60	130	22	10
3255/2	32550020011	3,75	0,5	3,0	75	155	32	10
3255/3	32550030011	4,30	0,6	3,5	100	180	50	10
3255/4	32550040011	5,00	0,8	4,0	125	215	52	10
3255/5	32550050011	5,65	0,8	5,0	150	250	76	10

3260



Schraubendreher
DIN 5265
Klinge DIN 5264
Vergaser-Schraubendreher

Screwdriver
DIN 5265
blade DIN 5264
Slotted stubby screwdriver

Artikel-Nr. Order-No.	Ident-Nr. Ident-No.	€	mm	mm	mm	mm		
3260/1	32600010011	4,20	0,8	4,0	100	190	57	10
3260/2	32600020011	5,30	1,0	5,5	125	225	85	10
3260/3	32600030011	6,30	1,2	6,5	150	250	102	10
3260/4	32600040011	8,55	1,2	8,0	175	285	147	10
3260/5	32600050011	8,90	1,6	8,0	175	285	148	10
3260/6	32600060011	11,20	1,6	10,0	200	310	181	10
3260/01	32600001011	4,50	1,2	6,5	25	75	47	10
3260/02	32600002011	4,75	1,2	8,0	25	75	51	10

3265



Schraubendreher mit Sechskant
DIN 5265
Klinge DIN 5264





Slotted engineer's screwdriver with hexagon nut
DIN 5265
blade DIN 5264

Artikel-Nr. Order-No.	Ident-Nr. Ident-No.	€	mm	mm	mm	mm		
3265/1	32650010011	7,10	1,0	5,5	100	200	87	10
3265/2	32650020011	8,55	1,2	6,5	125	225	110	10
3265/3	32650030011	11,50	1,2	8,0	150	260	162	10
3265/4	32650040011	12,85	1,6	10,0	175	285	202	10
3265/5	32650050011	17,30	2,0	12,0	200	310	273	10
3265/6	32650060011	21,70	2,5	14,0	250	360	283	10

Schraubendreher Philips 
DIN 8764-2
Klinge DIN 8764-I

Screwdriver Philips 
DIN 8764-2
blade DIN 8764-I

3270





Artikel-Nr. Order-No.	Ident-Nr. Ident-No.	€		 mm	 mm		
3270/0	32700000011	3,95	0	60	130	28	10
3270/1	32700010011	4,65	1	80	170	62	10
3270/2	32700020011	6,50	2	100	200	91	10
3270/3	32700030011	10,30	3	150	260	160	10
3270/01	32700001011	4,60	1	25	75	42	10
3270/02	32700002011	4,85	2	25	75	47	10



Schraubendreher Philips mit Sechskant 
DIN 8764-2
Klinge DIN 8764-I

Screwdriver Philips with hexagon nut 
DIN 8764-2
blade DIN 8764-I

3272





Artikel-Nr. Order-No.	Ident-Nr. Ident-No.	€		 mm	 mm		
3272/1	32720010011	6,50	1	80	170	66	10
3272/2	32720020011	8,15	2	100	200	99	10
3272/3	32720030011	11,65	3	150	260	163	10
3272/4	32720040011	16,75	4	200	310	272	10



Schraubendreher Pozidriv 
DIN 8764-2
Klinge DIN 8764-I

Screwdriver Pozidriv 
DIN 8764-2
blade DIN 8764-I

3275





Artikel-Nr. Order-No.	Ident-Nr. Ident-No.	€		 mm	 mm		
3275/0	32750000011	5,40	0	60	130	28	10
3275/1	32750010011	6,55	1	80	170	62	10
3275/2	32750020011	8,20	2	100	200	93	10
3275/3	32750030011	11,70	3	150	260	159	10
3275/4	32750040011	17,25	4	200	310	237	10



TX-Schraubendreher 

TX screwdriver 

3277

Artikel-Nr. Order-No.	Ident-Nr. Ident-No.	€		 mm	 mm		
3277/1	32770060011	6,55	TX 6	70	150	36	10
3277/2	32770070011	6,55	TX 7	70	150	37	10
3277/3	32770080011	7,10	TX 8	70	150	37	10
3277/4	32770090011	7,10	TX 9	70	150	37	10
3277/5	32770100011	7,55	TX 10	80	170	51	10
3277/6	32770150011	7,55	TX 15	80	170	54	10
3277/7	32770200011	7,55	TX 20	90	180	57	10
3277/8	32770250011	7,55	TX 25	90	180	61	10
3277/9	32770270011	8,90	TX 27	110	210	87	5
3277/10	32770300011	8,95	TX 30	110	210	95	5
3277/11	32770400011	9,65	TX 40	120	230	133	5
3277/12	32770450011	12,30	TX 45	120	230	151	5









Schraubendreher Screwdrivers

3278



TX-Schraubendreher 
mit stirnseitiger Bohrung

TX screwdriver 
tamperproof





Artikel-Nr. Order-No.	Ident-Nr. Ident-No.	€			 mm	 mm		
3278/ 8	3278 0080 011	8,60	S-TX 08	0,8 x 1,2	70	150	37	10
3278/ 9	3278 0090 011	8,60	S-TX 09	0,9 x 1,3	70	150	37	10
3278/10	3278 0100 011	8,90	S-TX 10	1,0 x 1,5	80	170	51	10
3278/15	3278 0150 011	9,10	S-TX 15	1,3 x 1,7	80	170	54	10
3278/20	3278 0200 011	9,45	S-TX 20	1,6 x 2,0	90	180	57	10
3278/25	3278 0250 011	9,50	S-TX 25	2,0 x 2,3	90	180	61	10
3278/27	3278 0270 011	10,35	S-TX 27	2,3 x 2,5	110	210	87	5
3278/30	3278 0300 011	11,00	S-TX 30	2,8 x 3,0	110	210	95	5
3278/40	3278 0400 011	12,95	S-TX 40	3,2 x 3,5	120	230	133	5
3278/45	3278 0450 011	15,44	S-TX 45	3,5 x 3,5	120	230	151	5

3281



Kugelpf-Schraubendreher 
für Innensechskantschrauben, schraubt schwer
zugänglich liegende Schrauben unter einem Winkel
bis zu 25°

Ball ended hexagon screwdriver 
allows to work in an angle of up to 25° at
difficult to reach sites



Artikel-Nr. Order-No.	Ident-Nr. Ident-No.	€		 mm	 mm		
3281/1	32810030011	3,25	3	100	170	29	10
3281/2	32810040011	3,55	4	100	180	45	10
3281/3	32810050011	4,05	5	100	190	67	10
3281/4	32810060011	4,90	6	125	225	99	10
3281/5	32810080011	5,60	8	150	250	141	10
3281/6	32810100011	7,35	10	150	260	215	10

3280



Schraubendreher-Satz in Display-Karton
7 teilig

Screwdriver set in display box
7 pcs.

Artikel-Nr. Order-No.	Ident-Nr. Ident-No.	€	Inhalt Contents		
3280	32800073011	42,90	3260/1, 2, 3 3265/2 3270/0,1, 2	560	1

Werkstattsschraubendreher mit Holzheft

- Klinge aus Chrom-Vanadium-Stahl
- vernickelt mit angestauchtem Sechskant, durchgehend

Workshop screwdrivers with wooden handle







- end to end blade made of chrome vanadium steel
- nickel plated with hexagon nut

Schraubendreher mit Sechskant 
DIN 5265
Klinge DIN 5264

Screwdriver with hexagon nut 
DIN 5265
blade DIN 5264

3010







Artikel-Nr. Order-No.	Ident-Nr. Ident-No.	€	 mm	 mm	 mm	 mm		
3010/0	42153	3,95	0,6	3,5	75	170	52	10
3010/00	42163	4,10	0,8	4,5	90	185	55	10
3010/1	42173	4,50	1,0	5,5	100	200	70	10
3010/2	42183	5,70	1,2	6,5	125	235	100	10
3010/3	42193	6,90	1,2	8,0	150	270	160	10
3010/4	42203	8,00	1,6	10,0	175	300	200	10
3010/5	42213	10,35	2,0	12,0	200	330	220	10
3010/6	42223	13,65	2,5	14,0	250	380	420	10

Kreuzschlitz-Schraubendreher mit Sechskant 
DIN 8764-2
Klinge DIN 8764-1

Screwdriver with hexagon nut 
DIN 8764-2
blade DIN 8764-1

3015





Artikel-Nr. Order-No.	Ident-Nr. Ident-No.	€		 mm	 mm		
3015/1	42113	5,35	1	80	175	50	10
3015/2	42123	6,60	2	100	210	85	10
3015/3	42133	9,30	3	150	270	160	5
3015/4	42143	12,90	4	200	330	360	5

Schraubendreher-Satz in Display-Karton
7 teilig

screwdriver set in display box
7 pcs.

3010/15



Artikel-Nr. Order-No.	Ident-Nr. Ident-No.	€	Inhalt Contents		
3010/15	42150	38,00	3010/0,00,1,2,3 3015/1,2	585	1

Schraubendreher Screwdrivers

Profi-Industrie Schraubendreher

- Klingen aus Chrom-Vanadium-Stahl
- phosphatiert
- ergonomisch geformter, schlagfester Griff mit Aufhängeloch
- Griffmaterial ist beständig gegen Laugen, Lösungsmittel und Säuren, temperaturbeständig zwischen -30° bis +80°C.

Screwdrivers „Industry“

- made of chrome vanadium steel
- phosphatized
- ergonomically shaped, impact-resistant handle
- handle resistant against solvents, acids and bases,
- temperature resistance from -30° to +80°C

3030



Schraubendreher mit Sechskant
DIN 5265
Klinge DIN 5264

Slotted engineer's screwdriver with hexagon nut
DIN 5265
blade DIN 5264

Artikel-Nr. Order-No.	Ident-Nr. Ident-No.	€	$\frac{x}{x}$ mm	mm $\frac{x}{x}$	$\frac{x}{x}$ mm	$\frac{x}{x}$ mm		
3030/0	30301000040	4,10	0,6	3,5	75	155	34	10
3030/00	30300000040	4,45	0,8	4,5	90	180	47	10
3030/1	30300010040	5,20	1,0	5,5	100	200	67	10
3030/2	30300020040	6,25	1,2	6,5	125	225	92	10
3030/3	30300030040	8,55	1,2	8,0	150	260	136	10
3030/4	30300040040	8,90	1,6	10,0	175	285	176	10
3030/5	30300050040	12,85	2,0	12,0	200	310	248	10
3030/6	30300060040	15,60	2,5	14,0	250	360	305	10

3040



Schraubendreher
DIN 5265
Klinge DIN 5264

Slotted engineer's screwdriver
DIN 5265
blade DIN 5264

Artikel-Nr. Order-No.	Ident-Nr. Ident-No.	€	$\frac{x}{x}$ mm	mm $\frac{x}{x}$	$\frac{x}{x}$ mm	$\frac{x}{x}$ mm		
3040/1	30400010040	3,25	0,8	4,0	100	190	43	10
3040/2	30400020040	3,50	1,0	5,5	125	225	65	10
3040/3	30400030040	4,75	1,2	6,5	150	250	82	10
3040/4	30400040040	5,40	1,2	8,0	125	235	120	10
3040/5	30400050040	7,25	1,6	10,0	200	310	154	10
3040/6	30400060040	5,30	2,0	12,0	250	360	212	10
3040/7	30400070040	12,20	2,5	14,0	250	360	290	10

3050



Elektriker-Schraubendreher
DIN 5265
Klinge DIN 5264

Slotted instrument screwdriver
DIN 5265
blade DIN 5264

Artikel-Nr. Order-No.	Ident-Nr. Ident-No.	€	$\frac{x}{x}$ mm	mm $\frac{x}{x}$	$\frac{x}{x}$ mm	$\frac{x}{x}$ mm		
3050/1	30500010040	2,25	0,4	2,5	60	130	17	10
3050/2	30500020040	2,35	0,5	3,0	75	155	26	10
3050/3	30500030040	3,10	0,6	4,0	100	190	43	10
3050/4	30500040040	3,20	0,6	4,0	125	215	46	10
3050/5	30500050040	4,20	0,8	5,0	150	250	69	10

3055



Elektriker-Schraubendreher
DIN 5265
mit schwarz isolierter Klinge
Klinge DIN 5264





Slotted instrument screwdriver
DIN 5265
with black insulated blade
blade DIN 5264

Artikel-Nr. Order-No.	Ident-Nr. Ident-No.	€	$\frac{x}{x}$ mm	mm $\frac{x}{x}$	$\frac{x}{x}$ mm	$\frac{x}{x}$ mm		
3055/1	30550010040	2,65	0,4	2,5	60	130	18	10
3055/2	30550020040	2,90	0,5	3,0	75	155	28	10
3055/3	30550030040	3,40	0,6	4,0	100	190	45	10
3055/4	30550040040	3,45	0,6	4,0	125	215	48	10
3055/5	30550050040	4,55	0,8	5,0	150	250	72	10

Schraubendreher Philips 
 DIN 8764-2
 Klinge DIN 8764-1

Screwdriver Philips 
 DIN 8764-2
 blade DIN 8764-1

3070







Artikel-Nr. Order-No.	Ident-Nr. Ident-No.	€					
3070/0	30700000040	2,80	0	60	130	21	10
3070/1	30700010040	3,25	1	80	170	48	10
3070/2	30700020040	4,30	2	100	200	72	10
3070/3	30700030040	6,80	3	150	260	134	10
3070/4	30700040040	8,10	4	200	310	212	10
3070/01	30700001040	3,15	1	25	75	25	10
3070/02	30700002040	3,60	2	25	75	27	10



Vergaser-Schraubendreher 
 DIN 5265
 Klinge DIN 5264

Slotted stubby screwdriver 
 DIN 5265
 blade DIN 5264

3080



Artikel-Nr. Order-No.	Ident-Nr. Ident-No.	€						
3080/1	30800010040	3,45	1,2	6,5	25	75	27	10
3080/2	30800020040	4,20	1,2	8,0	25	50	30	10



Schraubendreher-Satz in Display-Karton
 7 teilig

Screwdriver set in display box
 7 pcs.

3045





Artikel-Nr. Order-No.	Ident-Nr. Ident-No.	€	Inhalt Contents		
3045	30450073040	30,00	3040/2, 3 3050/2, 3 3070/1, 2, 3	530	1



Spannungsprüfer 
 entsprechend VDE-Norm für 220 - 250 Volt,
 mit Metall-Clip, Klinge isoliert

Voltage Tester 
 as per VDE-standard for 220 - 250 V, with metal clip,
 insulated blade

3130

Artikel-Nr. Order-No.	Ident-Nr. Ident-No.	€					
3130	43413	2,15	3,0	60	140	15	10



Schraubendreher Screwdrivers

Winkelschraubendreher

- für Innensechskantschrauben
- aus Chrom-Vandium-Stahl
- durchgehend gehärtete

1000 N

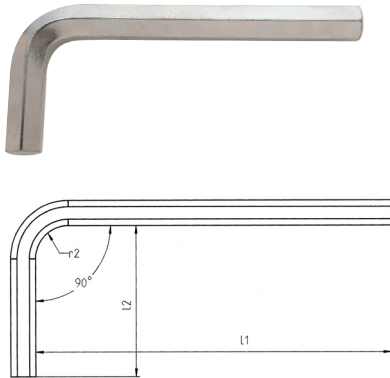

Offset screwdriver

- for hexagon socket screws
- made of chrome vandium steel
- fully hardened

Sechskant-Winkelschraubendreher
DIN ISO 2936 - (DIN 911)
Chrom-Vanadium-Stahl, vernickelt

Hexagon keys
DIN ISO 2936 - (DIN 911)
chrome vanadium steel, nickel plated

Artikel-Nr. Order-No.	Ident-Nr. Ident-No.	€	mm	L ₁	L ₂	⚖	📄
1000 N	I2613	0,25	1,5	45	14	1	10
1000 N	I2623	0,25	2,0	50	16	2	10
1000 N	I2633	0,30	2,5	56	18	4	10
1000 N	I2643	0,30	3,0	63	20	5	10
1000 N	I2653	0,45	3,5	67	23	8	10
1000 N	I2663	0,45	4,0	70	25	11	10
1000 N	I2645	0,55	4,5	75	26	14	10
1000 N	I2673	0,65	5,0	80	28	19	10
1000 N	I2675	0,75	5,5	85	30	23	10
1000 N	I2683	0,75	6,0	90	32	30	10
1000 N	I2693	0,95	7,0	95	34	45	10
1000 N	I2703	1,25	8,0	100	36	60	10
1000 N	I2713	1,65	9,0	105	38	81	10
1000 N	I2723	1,85	10,0	112	40	105	10
1000 N	I2733	2,50	11,0	119	40	134	10
1000 N	I2743	2,80	12,0	125	45	170	10
1000 N	I2843	3,65	13,0	133	50	210	10
1000 N	I2753	4,00	14,0	140	56	266	10
1000 N	I2763	7,10	17,0	160	63	444	10
1000 N	I2773	9,60	19,0	180	70	618	5
1000 N	I2783	14,15	22,0	200	80	950	5
1000 N	I2793	21,70	24,0	224	90	1260	1
1000 N	I2803	28,25	27,0	250	100	1780	1
1000 N	I2813	43,40	30,0	280	112	2460	1
1000 N	I2823	60,90	32,0	315	125	3140	1
1000 N	I2833	75,60	36,0	355	140	4470	1

1000 L

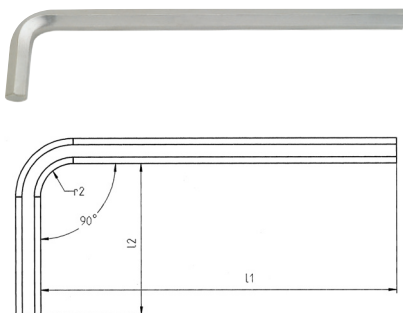

Sechskant-Winkelschraubendreher, lang
DIN ISO 2936 L - (DIN 911 L)
Chrom-Vanadium-Stahl, vernickelt



Hexagon keys, long pattern
DIN ISO 2936 L - (DIN 911 L)
chrome vanadium steel, nickel plated

Artikel-Nr. Order-No.	Ident-Nr. Ident-No.	€	mm	L ₁	L ₂	⚖	📄
1000 L	I3343	0,60	1,5	90	14	2	10
1000 L	I3353	0,55	2,0	100	16	3	10
1000 L	I3363	0,55	2,5	112	18	5	10
1000 L	I3373	0,65	3,0	126	20	8	10
1000 L	I3393	0,80	4,0	140	25	18	10
1000 L	I3403	1,00	5,0	160	28	31	10
1000 L	I3413	1,15	6,0	180	32	51	10
1000 L	I3423	2,00	7,0	190	34	74	10
1000 L	I3433	2,30	8,0	200	36	101	10
1000 L	I3443	3,00	9,0	210	38	135	10
1000 L	I3453	3,25	10,0	224	40	176	10
1000 L	I3473	4,10	12,0	250	45	282	10
1000 L	I3483	6,35	14,0	280	56	435	10
1000 L	I3493	11,20	17,0	320	63	730	5
1000 L	I3503	15,90	19,0	360	70	1020	1

Sechskant-Winkelschraubendreher 
 DIN ISO 2936 - (DIN 911)
 Spezial-Stahl, schwarz

Hexagon keys 
 DIN ISO 2936 - (DIN 911)
 Special steel, black

1000 WS

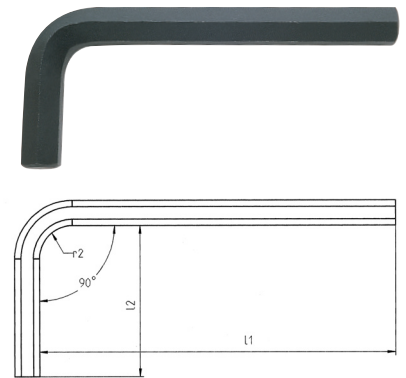

Artikel-Nr. Order-No.	Ident-Nr. Ident-No.	€	mm	L ₁	L ₂		
1000 WS	I2864	0,20	1,5	45	14	0,5	10
1000 WS	I2874	0,20	2,0	50	16	2	10
1000 WS	I2884	0,30	2,5	56	18	4	10
1000 WS	I2894	0,30	3,0	63	20	5	10
1000 WS	I2904	0,30	3,5	68	22	7	10
1000 WS	I2914	0,30	4,0	70	25	11	10
1000 WS	I2915	0,40	4,5	75	27	14	10
1000 WS	I2924	0,40	5,0	80	28	19	10
1000 WS	I2925	0,50	5,5	85	30	23	10
1000 WS	I2934	0,50	6,0	90	32	30	10
1000 WS	I2944	0,85	7,0	95	34	42	10
1000 WS	I2954	0,85	8,0	100	36	60	10
1000 WS	I2964	1,25	9,0	105	38	80	10
1000 WS	I2974	1,40	10,0	112	40	105	10
1000 WS	I2984	1,75	11,0	112	40	130	10
1000 WS	I2994	1,85	12,0	125	45	170	10
1000 WS	I3004	2,85	14,0	140	56	266	10
1000 WS	I3014	4,45	17,0	160	63	444	10
1000 WS	I3024	6,75	19,0	180	70	615	5
1000 WS	I3034	9,85	22,0	200	80	935	5
1000 WS	I3044	16,40	24,0	224	90	1250	1
1000 WS	I3045	19,95	27,0	250	100	1770	1
1000 WS	I3046	31,60	30,0	280	112	2460	1
1000 WS	I3047	41,35	32,0	315	125	3140	1
1000 WS	I3048	60,90	36,0	355	140	4400	1
1000 WS	I3049	160,00	41,0	401	153	6400	1
1000 WS	I3050	186,00	42,0	407	157	6800	1
1000 WS	I3051	215,00	46,0	444	166	8900	1
1000 WS	I3052	250,00	50,0	474	184	11300	1
1000 WS	I3058	275,00	55,0	520	194	14800	1
1000 WS	I3059	340,00	60,0	564	208	19100	1
1000 WS	I3060	525,00	65,0	689	223	23500	1



Sechskant-Winkelschraubendreher, lang 
 DIN ISO 2936 L - (DIN 911 L)
 mit Kugelkopf, Chrom-Vanadium-Stahl, vernickelt

Hexagon keys, long pattern 
 DIN ISO 2936 L - (DIN 911 L)
 ball end at long arm, chrome vanadium steel,
 nickel plated

1005

Artikel-Nr. Order-No.	Ident-Nr. Ident-No.	€	mm	L ₁	L ₂		
1005	I0050015030	1,85	1,5	90	14	3	10
1005	I0050020030	1,75	2,0	100	16	10	10
1005	I0050025030	1,85	2,5	112	18	15	10
1005	I0050030030	1,85	3,0	126	20	20	10
1005	I0050040030	2,20	4,0	140	25	25	10
1005	I0050050030	2,55	5,0	160	28	38	10
1005	I0050060030	2,95	6,0	180	32	58	10
1005	I0050070030	3,70	7,0	190	34	74	10
1005	I0050080030	3,70	8,0	200	36	110	10
1005	I0050100030	5,75	10,0	224	40	190	10
1005	I0050120030	7,15	12,0	250	45	300	10

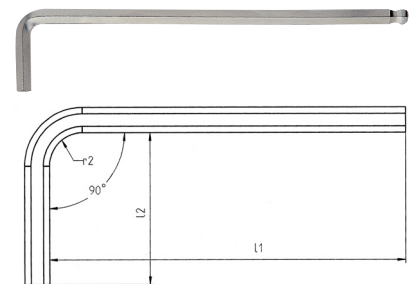

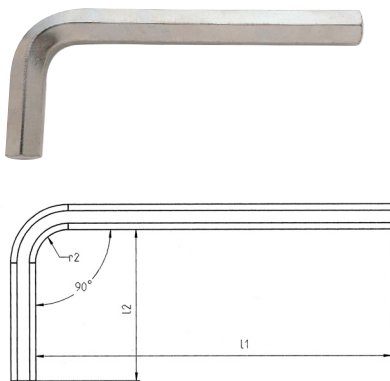

Schraubendreher Screwdrivers

1010 N



Sechskant-Winkelschraubendreher 
BS 2470
Chrom-Vanadium-Stahl, vernickelt

Hexagon keys 
BS 2470
chrome vanadium steel, nickel plated

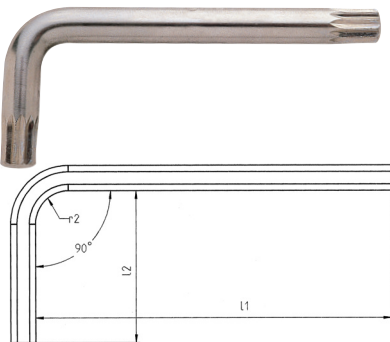

Artikel-Nr. Order-No.	Ident-Nr. Ident-No.	€	ΔAF	L ₁	L ₂		
1010 N	13543	0,30	1/16	44	14	1	10
1010 N	13553	0,30	5/64	48	16	2	10
1010 N	13563	0,30	3/32	51	17	3	10
1010 N	13565	0,40	7/64	54	18	4	10
1010 N	13573	0,45	1/8	57	19	6	10
1010 N	13733	0,45	9/64	60	20	7	10
1010 N	13583	0,55	5/32	63	21	10	10
1010 N	13593	0,65	3/16	70	24	15	10
1010 N	13603	0,75	7/32	76	26	24	10
1010 N	13613	0,85	1/4	82	28	33	10
1010 N	13623	1,35	9/32	92	31	47	10
1010 N	13633	1,35	5/16	95	31	53	10
1010 N	13643	1,50	11/32	102	35	70	10
1010 N	13653	1,80	3/8	108	35	85	10
1010 N	13663	2,80	7/16	115	40	127	10
1010 N	13673	3,60	1/2	133	41	185	10
1010 N	13683	4,00	9/16	146	44	249	10
1010 N	13693	7,45	5/8	160	47	342	10
1010 N	13703	11,35	3/4	178	70	603	5
1010 N	13713	12,30	7/8	200	80	905	1
1010 N	13723	21,45	1	222	89	1325	1

1020 N





Vielzahn-Winkelschraubendreher für XZN-Schrauben 
Chrom-Vanadium-Stahl, vernickelt

Keys for XZN screws with internal serration 
chrome vanadium steel, nickel plated

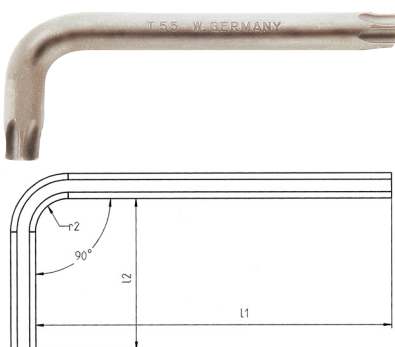

Artikel-Nr. Order-No.	Ident-Nr. Ident-No.	€	Nr. No.	L ₁	L ₂		
1020 N	13813	3,15	M 5	72	25	15	10
1020 N	13823	3,70	M 6	80	28	25	10
1020 N	13833	4,40	M 8	90	32	50	10
1020 N	13843	6,80	M 10	100	36	80	10
1020 N	13853	7,95	M 12	112	40	120	10
1020 N	13863	10,30	M 14	125	45	180	10

1040 N



TX Winkelschraubendreher 
Chrom-Vanadium-Stahl, vernickelt

TX keys 
chrome vanadium steel, nickel plated

Artikel-Nr. Order-No.	Ident-Nr. Ident-No.	€	Nr. No.	L ₁	L ₂		
1040 N	12514	4,55	T 10	50	16	4	10
1040 N	12524	4,55	T 15	54	18	5	10
1040 N	12534	4,55	T 20	57	19	7	10
1040 N	12544	4,90	T 25	63	20	10	10
1040 N	12554	4,90	T 27	67	23	13	10
1040 N	12564	4,90	T 30	70	25	20	10
1040 N	12574	5,30	T 40	76	25	29	10
1040 N	12584	6,30	T 45	85	30	45	10
1040 N	12594	6,80	T 50	95	34	62	10
1040 N	12604	11,45	T 55	108	36	113	10

Sechskant Winkelschraubendrehersatz mit Halter
Chrom-Vanadium-Stahl, vernickelt, Halter aus Metall,
mit Kunststoff-Griffschalen

Hexagon keys in clip holder
chrome vanadium steel, metal holder with plastic

1000 H
1010 H



Artikel-Nr. Order-No.	Ident-Nr. Ident-No.	€	Inhalt Contents		
1000 H / 7	I2840	10,80	1,5, 2, 2,5, 3, 4, 5, 6	140	I
1000 H / 70	I2841	16,25	2,5, 3, 4, 5, 6, 8, 10	350	I
1010 H / 7	I3736	10,80	1/16, 5/64, 3/32, 1/8, 5/32, 3/16, 7/32	130	I
1010 H / 70	I3737	16,25	3/32, 1/8, 5/32, 3/16, 1/4, 5/16, 3/8	340	I

Sechskant Winkelschraubendrehersatz in
Plastik-Tasche
Chrom-Vanadium-Stahl, vernickelt

Hexagon Keys in plastic bag
chrome vanadium steel, nickel plated

1000 T
1010 T

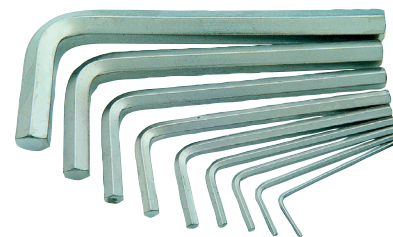

Artikel-Nr. Order-No.	Ident-Nr. Ident-No.	€	Inhalt Contents		
1000 T / 7	I3053	3,75	1,5, 2, 2,5, 3, 4, 5, 6	65	I
1000 T / 80	I3056	10,95	3, 4, 5, 6, 8, 10, 12	445	I
1000 T / 9	I3063	7,20	1,5, 2, 2,5, 3, 4, 5, 6, 8, 10	230	I
1010 T / 8	I3743	4,65	1/16, 5/64, 3/32, 1/8, 5/32, 3/16, 7/32, 1/4	110	I
1010 T / 10	I3746	8,25	1/16, 5/64, 3/32, 1/8, 5/32, 3/16, 7/32, 1/4, 5/16, 3/8	250	I

Sechskant-Winkelschraubendrehersatz am Ring
Chrom-Vanadium-Stahl, vernickelt

Hexagon keys on ring
chrome vanadium steel, nickel plated

1000 R
1010 R

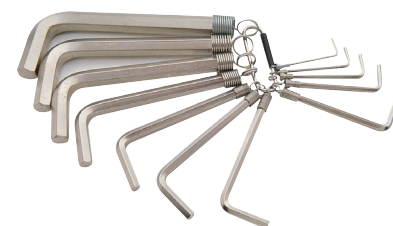

Artikel-Nr. Order-No.	Ident-Nr. Ident-No.	€	Inhalt Contents		
1000 / 12 R	I3089	16,20	1,5, 2, 2,5, 3, 4, 5, 5,5, 6, 8, 10, 11, 12	445	I
1010 / 12 R	I3756	17,50	1/16, 5/64, 3/32, 1/8, 5/32, 3/16, 7/32, 1/4, 5/16, 3/8, 7/16, 1/2	570	I

TX Winkelschraubendrehersatz mit Halter
Chrom-Vanadium-Stahl, vernickelt, Halter aus Metall,
mit Kunststoff-Griffschalen

TX keys in clip holder
chrome vanadium steel, metal holder with plastic

1000 R
1010 R



Artikel-Nr. Order-No.	Ident-Nr. Ident-No.	€	Inhalt Contents		
1000 R / 8	I3099	18,50	T09, T10, T15, T20, T25, T27, T30, T40	240	I

Schraubendreher Screwdrivers

- neu entwickeltes, ergonomisches Design
- 2-farbiger Stiftschlüssel Drehhalter
- Hochschlagfester Spezial-Kunststoff
- einfaches Entnehmen der Schlüssel durch patentrechtlich geschützte Drehtechnik
- Drehmodul arretiert in allen 90°-Positionen

- newly developed ergonomic design
- 2-color rotary holder for hexagon keys
- high impact special plastics
- easy removal of the key by a patent rotation technique
- rotating modul engages in all 90° positions



I000 SB

I010 SB



Sechskant-Winkelschraubendrehersatz 
in Kunststoffhalter; Chrom-Vanadium-Stahl, vernickelt

Hexagon keys 
in plastic holder; chrome vanadium steel, nickel plated

Artikel-Nr. Order-No.	Ident-Nr. Ident-No.	€	Inhalt Contents		
I000 SB 9	I0000098030	8,70	1,5, 2, 2,5, 3, 4, 5, 6, 8, 10	275	6
I010 SB 10	I0100108030	9,75	1/16, 5/64, 3/32, 1/8, 5/32, 3/16, 7/32, 1/4, 5/16, 3/8	300	6

I000 L SB



I010 L SB

I005 SB





Sechskant-Winkelschraubendrehersatz 
lange Ausführung
in Kunststoffhalter; Chrom-Vanadium-Stahl, vernickelt

Hexagon keys 
long version
in plastic holder; chrome vanadium steel, nickel plated

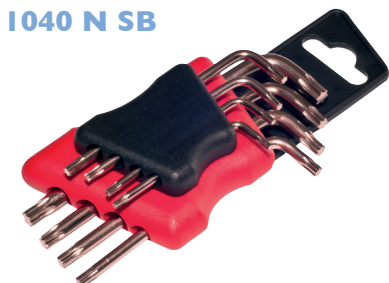

Artikel-Nr. Order-No.	Ident-Nr. Ident-No.	€	Inhalt Contents		
I000 LSB 9	I0000198030	13,85	1,5, 2, 2,5, 3, 4, 5, 6, 8, 10	445	6
I010 LSB 10	I0100198030	15,00	1/16, 5/64, 3/32, 1/8, 5/32, 3/16, 7/32, 1/4, 5/16, 3/8	460	6
I005 LSB 9 mit Kugelkopf	I0050098030	26,00	1,5, 2, 2,5, 3, 4, 5, 6, 8, 10	445	6

I040 N SB



Satz TX-Winkelschraubendreher 
Chrom-Vanadium-Stahl, vernickelt

Set of TX keys for TORX screws 
Euro hole, chrome vanadium steel, nickel plated

Artikel-Nr. Order-No.	Ident-Nr. Ident-No.	€	Inhalt Contents		
I040 N SB	I0400098030	37,80	T09, T10, T15, T20, T25, T27, T30, T40	175	1



Winkelschraubendreher
Hexagon keys

Sechskant-Schraubendreher 
mit Kunststoff-Quergriff, Chrom-Vanadium-Stahl,
Klinge vernickelt

T-handled hexagon keys 
chrome vanadium steel, blade nickel plated, with
plastic t-handle

1001 N

Artikel-Nr. Order-No.	Ident-Nr. Ident-No.	€	mm	mm	mm	mm	mm	mm
1001 N	10010215030	3,60	2	100	70	16	10	
1001 N	10012515030	3,65	2,5	100	70	19	10	
1001 N	10010315030	3,65	3	100	70	22	10	
1001 N	10010415030	4,10	4	150	90	41	10	
1001 N	10010515030	4,40	5	150	90	50	10	
1001 N	10010615030	4,80	6	150	90	60	10	
1001 N	10010815030	5,30	8	150	110	107	10	
1001 N	10011015030	6,50	10	150	110	170	10	

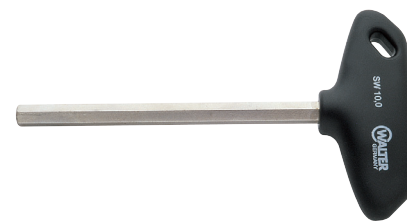

Sechskant T-Griff mit Halter 
mit Kunststoff-Quergriff, Chrom-Vanadium-Stahl,
Klinge vernickelt

T-handled hexagon keys in holder 
chrome vanadium steel, blade nickel plated, with
plastic t-handle

1001 H

Artikel-Nr. Order-No.	Ident-Nr. Ident-No.	€	Inhalt Contents	mm	mm
1001 H	10010198030	37,00	2, 2,5, 3, 4, 5, 6, 8, 10	500	1



Sechskant-Schraubendreher 
mit Kunststoff-Quergriff, schwarz isolierte Klinge,
Chrom-Vanadium-Stahl, vernickelt

T-handled hexagon keys 
blade black insulated, chrome vanadium steel,
nickel plated, with plastic t-handle

1002

Artikel-Nr. Order-No.	Ident-Nr. Ident-No.	€	mm	mm	mm	mm	mm	mm
1002	10022515030	4,45	2,5	2,5	150	70	23	10
1002	10020315030	4,45	3	3,0	150	70	27	10
1002	10020415030	4,65	4	4,0	150	70	36	10
1002	10020515030	4,80	5	5,0	150	70	46	10
1002	10020615030	5,35	6	6,0	150	90	74	10
1002	10020815030	5,90	8	8,0	150	90	108	10
1002	10021015030	7,10	10	10,0	150	110	175	10



TX Winkelschraubendreher 
mit Kunststoff-Quergriff, Chrom-Vanadium-Stahl,
vernickelt

TX keys 
chrome vanadium steel, nickel plated, with plastic
t-handle

1006 N

Artikel-Nr. Order-No.	Ident-Nr. Ident-No.	€	mm	mm	mm	mm	mm	mm
1006 N	10060815030	4,20	T8	100	70	34	10	
1006 N	10060915030	4,20	T9	100	70	36	10	
1006 N	10061015030	4,20	T10	100	70	36	10	
1006 N	10061515030	4,30	T15	100	70	40	10	
1006 N	10062015030	4,90	T20	125	90	44	10	
1006 N	10062515030	5,10	T25	125	90	48	10	
1006 N	10063015030	5,60	T30	125	90	63	10	
1006 N	10064015030	6,40	T40	125	110	98	10	



TX Winkelschraubendreher mit Halter 
mit Kunststoff-Quergriff, Chrom-Vanadium-Stahl,
vernickelt

TX keys in holder 
chrome vanadium steel, nickel plated, with plastic
t-handle

1006 H

Artikel-Nr. Order-No.	Ident-Nr. Ident-No.	€	Inhalt Contents	mm	mm
1006 H	10060098030	39,00	T8, T9, T10, T15, T20, T25, T30, T40	500	1

