

# Schraubendreher

**Screwdrivers**

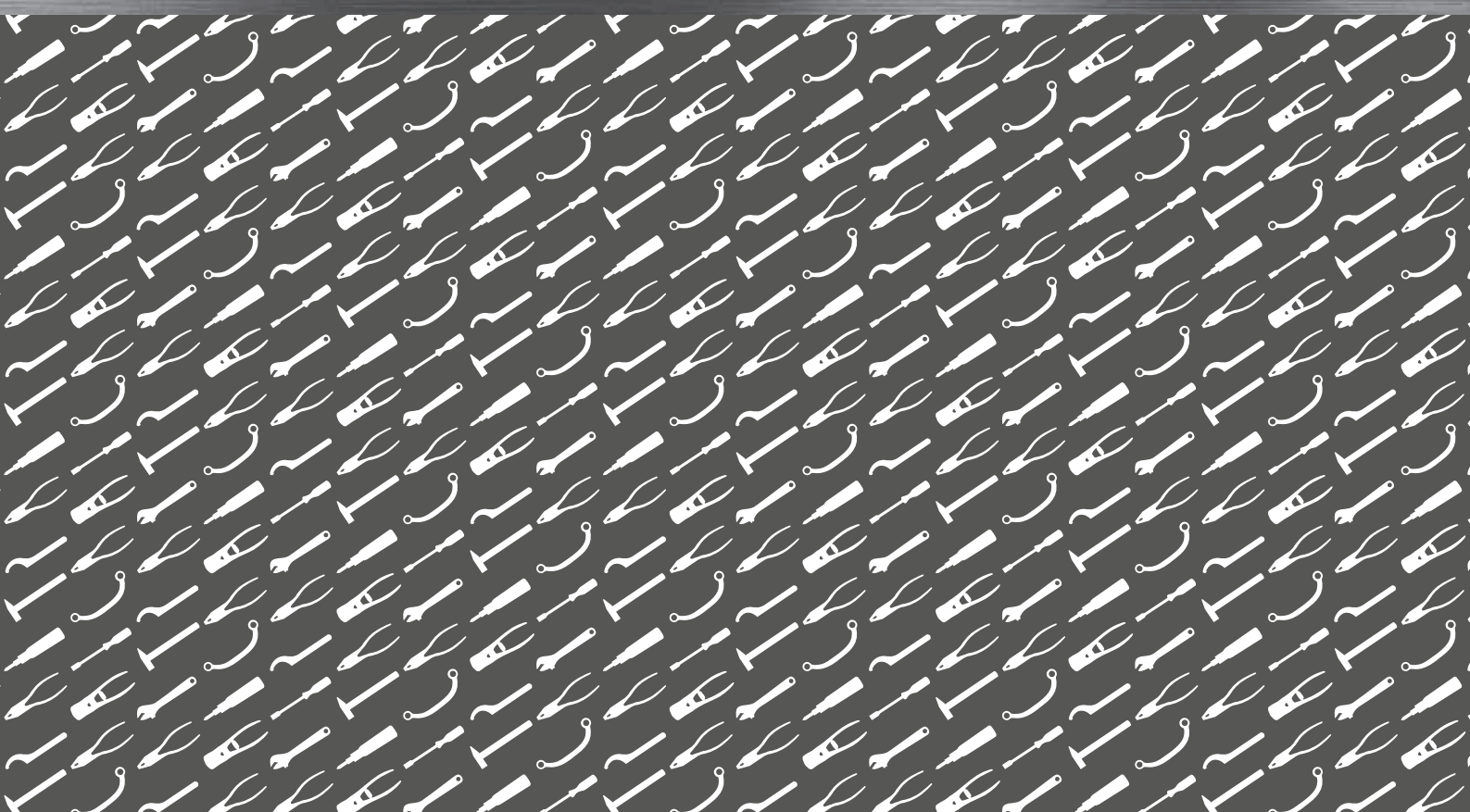

# Schraubendreher Screwdrivers

## 2-Komponenten-Schraubendreher

- für höchste Ansprüche bei Drehmomentübertragung und ermüdungsfreiem Schrauben
- Klingen aus hochwertigem Molybdän-Vanadium- bzw. Chrom-Vanadium-Stahl, verchromt mit schwarzer Spitze
- ergonomisch geformter 2-K-Griff in modernem Design aus PP/TPE-Material mit Aufhängeloch.
- der Griff ist schlagzäh und beständig gegen handelsübliche Laugen, Lösungsmittel und Säuren.
- die Einsatzfähigkeit ist in Temperaturbereichen zwischen  $-30^{\circ}$  und  $+80^{\circ}$  gewährleistet.

## Dual compound handle screwdrivers







- for highest demands regarding torquing and anti tiring tightening.
- high quality molybdenum vanadium or chrome vanadium steel, chrome plated with black tip.
- ergonomical 2-C-handle in modern design, PP/TPE-material with hole.
- impact resistance handle.
- resistant against solvents, acids and bases temperature resistance from  $-30^{\circ}$  to  $+80^{\circ}\text{C}$

Schraubendreher  
DIN 5265  
Klinge DIN 5264

Slotted engineer's screwdriver  
DIN 5265  
blade DIN 5264

3290







Artikel-Nr. Order-No.	Ident-Nr. Ident-No.		 mm	 mm	 mm	 mm		
3290 / 1	3290 0010 011		1,0	5,5	125	235	88	10
3290/2	3290 0020 011		1,2	6,5	125	235	101	10
3290/3	3290 0030 011		1,2	8,0	150	270	143	10
3290/4	3290 0040 011		1,6	10,0	200	320	214	10
3290/5	3290 0050 011		2,0	12,0	200	320	249	10
3290/6	3290 0060 011		2,5	14,0	300	420	363	10

Schraubendreher Philips  
DIN 5265  
Klinge DIN 5264

Screwdriver Philips  
DIN 5265  
blade DIN 5264

3294







Artikel-Nr. Order-No.	Ident-Nr. Ident-No.			 mm	 mm		
3294/0	3294 0000 011		0	60	150	42	10
3294/1	3294 0010 011		1	80	180	66	10
3294/2	3294 0020 011		2	100	210	96	10
3294/3	3294 0030 011		3	150	270	164	10

Schraubendreher Pozidriv  
DIN 5265  
Klinge DIN 5264

Screwdriver Pozidriv  
DIN 5265  
blade DIN 5264

3296







Artikel-Nr. Order-No.	Ident-Nr. Ident-No.			 mm	 mm		
3296/0	3296 0000 011		0	60	150	42	10
3296/1	3296 0010 011		1	80	180	66	10
3296/2	3296 0020 011		2	100	210	96	10
3296/3	3296 0030 011		3	150	270	164	10

# Schraubendreher Screwdrivers

## TX-Schraubendreher

## TX screwdriver

Artikel-Nr. Order-No.	Ident-Nr. Ident-No.			 mm	 mm		
3297/6	3297 0060 011		TX 6	70	160	40	10
3297/7	3297 0070 011		TX 7	70	160	40	10
3297/8	3297 0080 011		TX 8	70	160	40	10
3297/9	3297 0090 011		TX 9	70	160	40	10
3297/10	3297 0100 011		TX 10	80	180	53	10
3297/15	3297 0150 011		TX 15	80	180	56	10
3297/20	3297 0200 011		TX 20	90	190	60	10
3297/25	3297 0250 011		TX 25	90	190	64	10
3297/27	3297 0270 011		TX 27	110	220	92	5
3297/30	3297 0300 011		TX 30	110	220	98	5
3297/40	3297 0400 011		TX 40	120	240	134	5
3297/45	3297 0450 011		TX 45	120	240	154	5

3297







## Kugelpf-Schraubendreher

schraubt schwer zugänglich liegende Schrauben unter einem Winkel bis zu 25°

## Ball ended hexagon screwdriver

allows working in an angle of up to 25° at difficult to reach sites

Artikel-Nr. Order-No.	Ident-Nr. Ident-No.			 mm	 mm		
3299/3	3299 0030 011		3	100	190	43	10
3299/4	3299 0040 011		4	100	200	62	10
3299/5	3299 0050 011		5	100	200	71	10
3299/6	3299 0060 011		6	125	235	105	10
3299/8	3299 0080 011		8	150	260	152	10
3299/10	3299 0100 011		10	150	270	229	10

3299



# Schraubendreher Screwdrivers

## Profi-Werkstatt-Schraubendreher

- Klingen aus Molybdän-Vanadium- bzw. Chrom-Vanadium-Stahl und schwarzer Spitze
- ergonomisch geformter, schlagfester Griff mit Aufhängeloch
- Griffmaterial ist beständig gegen aggressive chemische Substanzen, Temperatureinsatzbereich zwischen -30° bis +80°C

## Screwdrivers „Workshop“

- made of molybdenum vanadium or chrome vanadium steel, chrome plated with black tip
- ergonomically shaped, impact-resistant handle
- handle resistant against solvents acids and bases temperature resistance from -30°to +80°C

Elektriker-Schraubendreher  
DIN 5265  
Klinge DIN 5264

Slotted instrument screwdriver  
DIN 5265  
blade DIN 5264

Artikel-Nr. Order-No.	Ident-Nr. Ident-No.		$\frac{x}{x}$ mm	mm $\frac{x}{x}$	$\frac{x}{x}$ mm	$\frac{x}{x}$ mm		
3250/1	32500010011		0,4	2,5	60	130	20	10
3250/2	32500020011		0,5	3,0	75	155	30	10
3250/3	32500030011		0,6	3,5	100	180	47	10
3250/4	32500040011		0,8	4,0	125	215	50	10
3250/5	32500050011		0,8	5,0	150	250	75	10



Elektriker-Schraubendreher  
DIN 5265  
Klinge DIN 5264  
mit rot transparent isolierter Klinge

Slotted instrument screwdriver  
DIN 5265  
blade DIN 5264  
red transparent insulated blade

Artikel-Nr. Order-No.	Ident-Nr. Ident-No.		$\frac{x}{x}$ mm	mm $\frac{x}{x}$	$\frac{x}{x}$ mm	$\frac{x}{x}$ mm		
3255/1	32550010011		0,4	2,5	60	130	22	10
3255/2	32550020011		0,5	3,0	75	155	32	10
3255/3	32550030011		0,6	3,5	100	180	50	10
3255/4	32550040011		0,8	4,0	125	215	52	10
3255/5	32550050011		0,8	5,0	150	250	76	10



Schraubendreher  
DIN 5265  
Klinge DIN 5264  
Vergaser-Schraubendreher

Screwdriver  
DIN 5265  
blade DIN 5264  
Slotted stubby screwdriver

Artikel-Nr. Order-No.	Ident-Nr. Ident-No.		$\frac{x}{x}$ mm	mm $\frac{x}{x}$	$\frac{x}{x}$ mm	$\frac{x}{x}$ mm		
3260/1	32600010011		0,8	4,0	100	190	57	10
3260/2	32600020011		1,0	5,5	125	225	85	10
3260/3	32600030011		1,2	6,5	150	250	102	10
3260/4	32600040011		1,2	8,0	175	285	147	10
3260/5	32600050011		1,6	8,0	175	285	148	10
3260/6	32600060011		1,6	10,0	200	310	181	10
3260/01	32600001011		1,2	6,5	25	75	47	10
3260/02	32600002011		1,2	8,0	25	75	51	10



Schraubendreher mit Sechskant  
DIN 5265  
Klinge DIN 5264

Slotted engineer's screwdriver with hexagon nut  
DIN 5265  
blade DIN 5264

Artikel-Nr. Order-No.	Ident-Nr. Ident-No.		$\frac{x}{x}$ mm	mm $\frac{x}{x}$	$\frac{x}{x}$ mm	$\frac{x}{x}$ mm		
3265/1	32650010011		1,0	5,5	100	200	87	10
3265/2	32650020011		1,2	6,5	125	225	110	10
3265/3	32650030011		1,2	8,0	150	260	162	10
3265/4	32650040011		1,6	10,0	175	285	202	10
3265/5	32650050011		2,0	12,0	200	310	273	10
3265/6	32650060011		2,5	14,0	250	360	283	10







# Schraubendreher Screwdrivers

Schraubendreher Philips   
DIN 8764-2  
Klinge DIN 8764-I

Screwdriver Philips   
DIN 8764-2  
blade DIN 8764-I

3270







Artikel-Nr. Order-No.	Ident-Nr. Ident-No.						
3270/0	32700000011		0	60	130	28	10
3270/1	32700010011		1	80	170	62	10
3270/2	32700020011		2	100	200	91	10
3270/3	32700030011		3	150	260	160	10
3270/01	32700001011		1	25	75	42	10
3270/02	32700002011		2	25	75	47	10

Schraubendreher Philips mit Sechskant   
DIN 8764-2  
Klinge DIN 8764-I

Screwdriver Philips with hexagon nut   
DIN 8764-2  
blade DIN 8764-I

3272







Artikel-Nr. Order-No.	Ident-Nr. Ident-No.						
3272/1	32720010011		1	80	170	66	10
3272/2	32720020011		2	100	200	99	10
3272/3	32720030011		3	150	260	163	10
3272/4	32720040011		4	200	310	272	10

Schraubendreher Pozidriv   
DIN 8764-2  
Klinge DIN 8764-I

Screwdriver Pozidriv   
DIN 8764-2  
blade DIN 8764-I

3275







Artikel-Nr. Order-No.	Ident-Nr. Ident-No.						
3275/0	32750000011		0	60	130	28	10
3275/1	32750010011		1	80	170	62	10
3275/2	32750020011		2	100	200	93	10
3275/3	32750030011		3	150	260	159	10
3275/4	32750040011		4	200	310	237	10

TX-Schraubendreher 

TX screwdriver 

3277









Artikel-Nr. Order-No.	Ident-Nr. Ident-No.						
3277/1	32770060011		TX 6	70	150	36	10
3277/2	32770070011		TX 7	70	150	37	10
3277/3	32770080011		TX 8	70	150	37	10
3277/4	32770090011		TX 9	70	150	37	10
3277/5	32770100011		TX 10	80	170	51	10
3277/6	32770150011		TX 15	80	170	54	10
3277/7	32770200011		TX 20	90	180	57	10
3277/8	32770250011		TX 25	90	180	61	10
3277/9	32770270011		TX 27	110	210	87	5
3277/10	32770300011		TX 30	110	210	95	5
3277/11	32770400011		TX 40	120	230	133	5
3277/12	32770450011		TX 45	120	230	151	5

# Schraubendreher Screwdrivers

TX-Schraubendreher   
mit stirnseitiger Bohrung

TX screwdriver   
tamperproof





Artikel-Nr. Order-No.	Ident-Nr. Ident-No.				 mm	 mm		
3278/ 8	3278 0080 011		S-TX 08	0,8 x 1,2	70	150	37	10
3278/ 9	3278 0090 011		S-TX 09	0,9 x 1,3	70	150	37	10
3278/10	3278 0100 011		S-TX 10	1,0 x 1,5	80	170	51	10
3278/15	3278 0150 011		S-TX 15	1,3 x 1,7	80	170	54	10
3278/20	3278 0200 011		S-TX 20	1,6 x 2,0	90	180	57	10
3278/25	3278 0250 011		S-TX 25	2,0 x 2,3	90	180	61	10
3278/27	3278 0270 011		S-TX 27	2,3 x 2,5	110	210	87	5
3278/30	3278 0300 011		S-TX 30	2,8 x 3,0	110	210	95	5
3278/40	3278 0400 011		S-TX 40	3,2 x 3,5	120	230	133	5
3278/45	3278 0450 011		S-TX 45	3,5 x 3,5	120	230	151	5



3278

Kugelpf-Schraubendreher   
für Innensechskantschrauben, schraubt schwer  
zugänglich liegende Schrauben unter einem Winkel  
bis zu 25°

Ball ended hexagon screwdriver   
allows to work in an angle of up to 25° at  
difficult to reach sites



Artikel-Nr. Order-No.	Ident-Nr. Ident-No.			 mm	 mm		
3281/1	32810030011		3	100	170	29	10
3281/2	32810040011		4	100	180	45	10
3281/3	32810050011		5	100	190	67	10
3281/4	32810060011		6	125	225	99	10
3281/5	32810080011		8	150	250	141	10
3281/6	32810100011		10	150	260	215	10



3281

Schraubendreher-Satz in Display-Karton  
7 teilig

Screwdriver set in display box  
7 pcs.

Artikel-Nr. Order-No.	Ident-Nr. Ident-No.	Inhalt Contents		
3280	32800073011	3260/1, 2, 3 3265/2 3270/0, 1, 2	560	1



3280

# Schraubendreher Screwdrivers

## Werkstattsschraubendreher mit Holzheft

- Klinge aus Chrom-Vanadium-Stahl
- vernickelt mit angestauchtem Sechskant, durchgehend







## Workshop screwdrivers with wooden handle

- end to end blade made of chrome vanadium steel
- nickel plated with hexagon nut

Schraubendreher mit Sechskant   
DIN 5265  
Klinge DIN 5264

Screwdriver with hexagon nut   
DIN 5265  
blade DIN 5264

3010





Artikel-Nr. Order-No.	Ident-Nr. Ident-No.	 mm	 mm	 mm	 mm		
3010/0	42153	0,6	3,5	75	170	52	10
3010/00	42163	0,8	4,5	90	185	55	10
3010/1	42173	1,0	5,5	100	200	70	10
3010/2	42183	1,2	6,5	125	235	100	10
3010/3	42193	1,2	8,0	150	270	160	10
3010/4	42203	1,6	10,0	175	300	200	10
3010/5	42213	2,0	12,0	200	330	220	10
3010/6	42223	2,5	14,0	250	380	420	10



Kreuzschlitz-Schraubendreher mit Sechskant   
DIN 8764-2  
Klinge DIN 8764-1

Screwdriver with hexagon nut   
DIN 8764-2  
blade DIN 8764-1

3015



Artikel-Nr. Order-No.	Ident-Nr. Ident-No.		 mm	 mm		
3015/1	42113	1	80	175	50	10
3015/2	42123	2	100	210	85	10
3015/3	42133	3	150	270	160	5
3015/4	42143	4	200	330	360	5



Schraubendreher-Satz in Display-Karton  
7 teilig

screwdriver set in display box  
7 pcs.

3010/15

Artikel-Nr. Order-No.	Ident-Nr. Ident-No.	Inhalt Contents		
3010/15	42150	3010/0,00,1,2,3 3015/1,2	585	1



# Schraubendreher Screwdrivers

## Profi-Industrie Schraubendreher







- Klängen aus Chrom-Vanadium-Stahl
- phosphatiert
- ergonomisch geformter, schlagfester Griff mit Aufhängeloch
- Griffmaterial ist beständig gegen Laugen, Lösungsmittel und Säuren, temperaturbeständig zwischen -30° bis +80°C.

## Screwdrivers „Industry“

- made of chrome vanadium steel
- phosphatized
- ergonomically shaped, impact-resistant handle
- handle resistant against solvents, acids and bases,
- temperature resistance from -30° to +80°C

Schraubendreher mit Sechskant  
DIN 5265  
Klinge DIN 5264

Slotted engineer's screwdriver with hexagon nut  
DIN 5265  
blade DIN 5264







Artikel-Nr. Order-No.	Ident-Nr. Ident-No.		 mm	 mm	 mm	 mm		
3030/0	30301000040		0,6	3,5	75	155	34	10
3030/00	30300000040		0,8	4,5	90	180	47	10
3030/1	30300010040		1,0	5,5	100	200	67	10
3030/2	30300020040		1,2	6,5	125	225	92	10
3030/3	30300030040		1,2	8,0	150	260	136	10
3030/4	30300040040		1,6	10,0	175	285	176	10
3030/5	30300050040		2,0	12,0	200	310	248	10
3030/6	30300060040		2,5	14,0	250	360	305	10



3030

Schraubendreher  
DIN 5265  
Klinge DIN 5264

Slotted engineer's screwdriver  
DIN 5265  
blade DIN 5264







Artikel-Nr. Order-No.	Ident-Nr. Ident-No.		 mm	 mm	 mm	 mm		
3040/1	30400010040		0,8	4,0	100	190	43	10
3040/2	30400020040		1,0	5,5	125	225	65	10
3040/3	30400030040		1,2	6,5	150	250	82	10
3040/4	30400040040		1,2	8,0	175	285	120	10
3040/5	30400050040		1,6	10,0	200	310	154	10
3040/6	30400060040		2,0	12,0	250	360	212	10
3040/7	30400070040		2,5	14,0	250	360	290	10



3040

Elektriker-Schraubendreher  
DIN 5265  
Klinge DIN 5264

Slotted instrument screwdriver  
DIN 5265  
blade DIN 5264







Artikel-Nr. Order-No.	Ident-Nr. Ident-No.		 mm	 mm	 mm	 mm		
3050/1	30500010040		0,4	2,5	60	130	17	10
3050/2	30500020040		0,5	3,0	75	155	26	10
3050/3	30500030040		0,6	4,0	100	190	43	10
3050/4	30500040040		0,6	4,0	125	215	46	10
3050/5	30500050040		0,8	5,0	150	250	69	10



3050

Elektriker-Schraubendreher  
DIN 5265  
mit schwarz isolierter Klinge  
Klinge DIN 5264

Slotted instrument screwdriver  
DIN 5265  
with black insulated blade  
blade DIN 5264

Artikel-Nr. Order-No.	Ident-Nr. Ident-No.		 mm	 mm	 mm	 mm		
3055/1	30550010040		0,4	2,5	60	130	18	10
3055/2	30550020040		0,5	3,0	75	155	28	10
3055/3	30550030040		0,6	4,0	100	190	45	10
3055/4	30550040040		0,6	4,0	125	215	48	10
3055/5	30550050040		0,8	5,0	150	250	72	10



3055







# Schraubendreher Screwdrivers

Schraubendreher Philips   
DIN 8764-2  
Klinge DIN 8764-I

Screwdriver Philips   
DIN 8764-2  
blade DIN 8764-I

3070







Artikel-Nr. Order-No.	Ident-Nr. Ident-No.						
3070/0	30700000040		0	60	130	21	10
3070/1	30700010040		1	80	170	48	10
3070/2	30700020040		2	100	200	72	10
3070/3	30700030040		3	150	260	134	10
3070/4	30700040040		4	200	310	212	10
3070/01	30700001040		1	25	75	25	10
3070/02	30700002040		2	25	75	27	10



Vergaser-Schraubendreher   
DIN 5265  
Klinge DIN 5264

Slotted stubby screwdriver   
DIN 5265  
blade DIN 5264

3080



Artikel-Nr. Order-No.	Ident-Nr. Ident-No.							
3080/1	30800010040		1,2	6,5	25	75	27	10
3080/2	30800020040		1,2	8,0	25	50	30	10



Schraubendreher-Satz in Display-Karton  
7 teilig

Screwdriver set in display box  
7 pcs.

3045





Artikel-Nr. Order-No.	Ident-Nr. Ident-No.	Inhalt Contents		
3045	30450073040	3040/2, 3 3050/2, 3 3070/1, 2, 3	530	1



Spannungsprüfer   
entsprechend VDE-Norm für 220 - 250 Volt,  
mit Metall-Clip, Klinge isoliert

Voltage Tester   
as per VDE-standard for 220 - 250 V, with metal clip,  
insulated blade

3130

Artikel-Nr. Order-No.	Ident-Nr. Ident-No.						
3130	43413		3,0	60	140	15	10





# Schraubendreher Screwdrivers

## Winkelschraubendreher

- für Innensechskantschrauben
- aus Chrom-Vandium-Stahl
- durchgehend gehärtete

Sechskant-Winkelschraubendreher   
DIN ISO 2936 - (DIN 911)  
Chrom-Vanadium-Stahl, vernickelt

Artikel-Nr. Order-No.	Ident-Nr. Ident-No.		$\varnothing$ mm	L <sub>1</sub>	L <sub>2</sub>		
1000 N	I2613		1,5	45	14	1	10
1000 N	I2623		2,0	50	16	2	10
1000 N	I2633		2,5	56	18	4	10
1000 N	I2643		3,0	63	20	5	10
1000 N	I2653		3,5	67	23	8	10
1000 N	I2663		4,0	70	25	11	10
1000 N	I2645		4,5	75	26	14	10
1000 N	I2673		5,0	80	28	19	10
1000 N	I2675		5,5	85	30	23	10
1000 N	I2683		6,0	90	32	30	10
1000 N	I2693		7,0	95	34	45	10
1000 N	I2703		8,0	100	36	60	10
1000 N	I2713		9,0	105	38	81	10
1000 N	I2723		10,0	112	40	105	10
1000 N	I2733		11,0	119	40	134	10
1000 N	I2743		12,0	125	45	170	10
1000 N	I2843		13,0	133	50	210	10
1000 N	I2753		14,0	140	56	266	10
1000 N	I2763		17,0	160	63	444	10
1000 N	I2773		19,0	180	70	618	5
1000 N	I2783		22,0	200	80	950	5
1000 N	I2793		24,0	224	90	1260	1
1000 N	I2803		27,0	250	100	1780	1
1000 N	I2813		30,0	280	112	2460	1
1000 N	I2823		32,0	315	125	3140	1
1000 N	I2833		36,0	355	140	4470	1

## Offset screwdriver



- for hexagon socket screws
- made of chrome vanadium steel
- fully hardened

Hexagon keys   
DIN ISO 2936 - (DIN 911)  
chrome vanadium steel, nickel plated

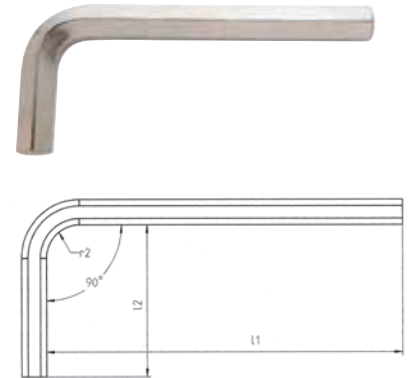
1000 N



Sechskant-Winkelschraubendreher, lang   
DIN ISO 2936 L - (DIN 911 L)  
Chrom-Vanadium-Stahl, vernickelt

Artikel-Nr. Order-No.	Ident-Nr. Ident-No.		$\varnothing$ mm	L <sub>1</sub>	L <sub>2</sub>		
1000 L	I3343		1,5	90	14	2	10
1000 L	I3353		2,0	100	16	3	10
1000 L	I3363		2,5	112	18	5	10
1000 L	I3373		3,0	126	20	8	10
1000 L	I3393		4,0	140	25	18	10
1000 L	I3403		5,0	160	28	31	10
1000 L	I3413		6,0	180	32	51	10
1000 L	I3423		7,0	190	34	74	10
1000 L	I3433		8,0	200	36	101	10
1000 L	I3443		9,0	210	38	135	10
1000 L	I3453		10,0	224	40	176	10
1000 L	I3473		12,0	250	45	282	10
1000 L	I3483		14,0	280	56	435	10
1000 L	I3493		17,0	320	63	730	5
1000 L	I3503		19,0	360	70	1020	1

Hexagon keys, long pattern   
DIN ISO 2936 L - (DIN 911 L)  
chrome vanadium steel, nickel plated

1000 L

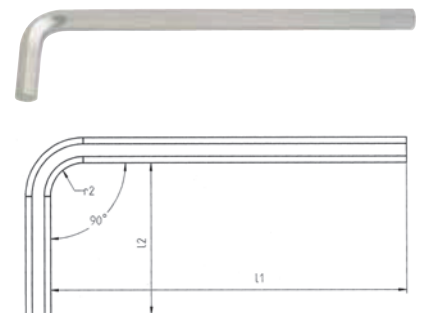



# Schraubendreher Screwdrivers

Sechskant-Winkelschraubendreher   
DIN ISO 2936 - (DIN 911)  
Spezial-Stahl, schwarz

Hexagon keys   
DIN ISO 2936 - (DIN 911)  
Special steel, black

**1000 WS**

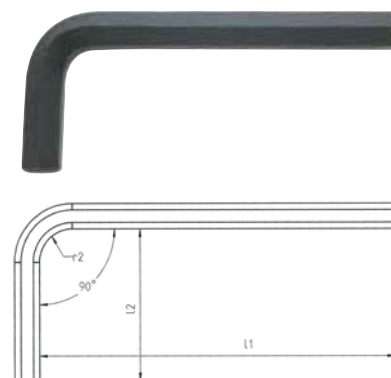

Artikel-Nr. Order-No.	Ident-Nr. Ident-No.		mm	L <sub>1</sub>	L <sub>2</sub>		
1000 WS	I2864		1,5	45	14	0,5	10
1000 WS	I2874		2,0	50	16	2	10
1000 WS	I2884		2,5	56	18	4	10
1000 WS	I2894		3,0	63	20	5	10
1000 WS	I2904		3,5	68	22	7	10
1000 WS	I2914		4,0	70	25	11	10
1000 WS	I2915		4,5	75	27	14	10
1000 WS	I2924		5,0	80	28	19	10
1000 WS	I2925		5,5	85	30	23	10
1000 WS	I2934		6,0	90	32	30	10
1000 WS	I2944		7,0	95	34	42	10
1000 WS	I2954		8,0	100	36	60	10
1000 WS	I2964		9,0	105	38	80	10
1000 WS	I2974		10,0	112	40	105	10
1000 WS	I2984		11,0	112	40	130	10
1000 WS	I2994		12,0	125	45	170	10
1000 WS	I3004		14,0	140	56	266	10
1000 WS	I3014		17,0	160	63	444	10
1000 WS	I3024		19,0	180	70	615	5
1000 WS	I3034		22,0	200	80	935	5
1000 WS	I3044		24,0	224	90	1250	1
1000 WS	I3045		27,0	250	100	1770	1
1000 WS	I3046		30,0	280	112	2460	1
1000 WS	I3047		32,0	315	125	3140	1
1000 WS	I3048		36,0	355	140	4400	1
1000 WS	I3049		41,0	401	153	6400	1
1000 WS	I3050		42,0	407	157	6800	1
1000 WS	I3051		46,0	444	166	8900	1
1000 WS	I3052		50,0	474	184	11300	1
1000 WS	I3058		55,0	520	194	14800	1
1000 WS	I3059		60,0	564	208	19100	1
1000 WS	I3060		65,0	689	223	23500	1



Sechskant-Winkelschraubendreher, lang   
DIN ISO 2936 L - (DIN 911 L)  
mit Kugelkopf, Chrom-Vanadium-Stahl, vernickelt

Hexagon keys, long pattern   
DIN ISO 2936 L - (DIN 911 L)  
ball end at long arm, chrome vanadium steel,  
nickel plated

**1005**

Artikel-Nr. Order-No.	Ident-Nr. Ident-No.		mm	L <sub>1</sub>	L <sub>2</sub>		
1005	I0050015030		1,5	90	14	3	10
1005	I0050020030		2,0	100	16	10	10
1005	I0050025030		2,5	112	18	15	10
1005	I0050030030		3,0	126	20	20	10
1005	I0050040030		4,0	140	25	25	10
1005	I0050050030		5,0	160	28	38	10
1005	I0050060030		6,0	180	32	58	10
1005	I0050070030		7,0	190	34	74	10
1005	I0050080030		8,0	200	36	110	10
1005	I0050100030		10,0	224	40	190	10
1005	I0050120030		12,0	250	45	300	10

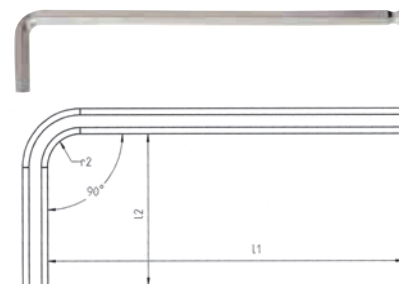



# Schraubendreher Screwdrivers

Sechskant-Winkelschraubendreher   
BS 2470  
Chrom-Vanadium-Stahl, vernickelt

Hexagon keys   
BS 2470  
chrome vanadium steel, nickel plated

1010 N

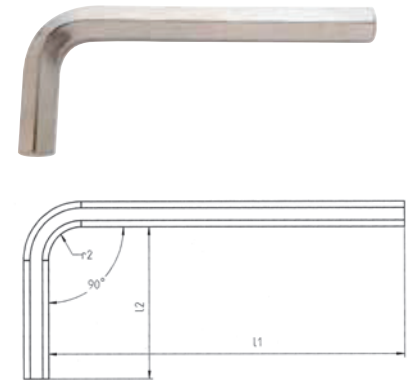

Artikel-Nr. Order-No.	Ident-Nr. Ident-No.		$\Delta AF$	L <sub>1</sub>	L <sub>2</sub>		
1010 N	13543		1/16	44	14	1	10
1010 N	13553		5/64	48	16	2	10
1010 N	13563		3/32	51	17	3	10
1010 N	13565		7/64	54	18	4	10
1010 N	13573		1/8	57	19	6	10
1010 N	13733		9/64	60	20	7	10
1010 N	13583		5/32	63	21	10	10
1010 N	13593		3/16	70	24	15	10
1010 N	13603		7/32	76	26	24	10
1010 N	13613		1/4	82	28	33	10
1010 N	13623		9/32	92	31	47	10
1010 N	13633		5/16	95	31	53	10
1010 N	13643		11/32	102	35	70	10
1010 N	13653		3/8	108	35	85	10
1010 N	13663		7/16	115	40	127	10
1010 N	13673		1/2	133	41	185	10
1010 N	13683		9/16	146	44	249	10
1010 N	13693		5/8	160	47	342	10
1010 N	13703		3/4	178	70	603	5
1010 N	13713		7/8	200	80	905	1
1010 N	13723		1	222	89	1325	1





Vielzahn-Winkelschraubendreher für XZN-Schrauben   
Chrom-Vanadium-Stahl, vernickelt

Keys for XZN screws with internal serration   
chrome vanadium steel, nickel plated

1020 N

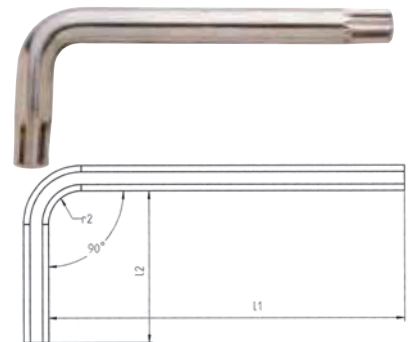

Artikel-Nr. Order-No.	Ident-Nr. Ident-No.	Nr. No.	L <sub>1</sub>	L <sub>2</sub>		
1020 N	13813	M 5	72	25	15	10
1020 N	13823	M 6	80	28	25	10
1020 N	13833	M 8	90	32	50	10
1020 N	13843	M 10	100	36	80	10
1020 N	13853	M 12	112	40	120	10
1020 N	13863	M 14	125	45	180	10



TX Winkelschraubendreher   
Chrom-Vanadium-Stahl, vernickelt

TX keys   
chrome vanadium steel, nickel plated

1040 N

Artikel-Nr. Order-No.	Ident-Nr. Ident-No.	Nr. No.	L <sub>1</sub>	L <sub>2</sub>		
1040 N	12514	T 10	50	16	4	10
1040 N	12524	T 15	54	18	5	10
1040 N	12534	T 20	57	19	7	10
1040 N	12544	T 25	63	20	10	10
1040 N	12554	T 27	67	23	13	10
1040 N	12564	T 30	70	25	20	10
1040 N	12574	T 40	76	25	29	10
1040 N	12584	T 45	85	30	45	10
1040 N	12594	T 50	95	34	62	10
1040 N	12604	T 55	108	36	113	10

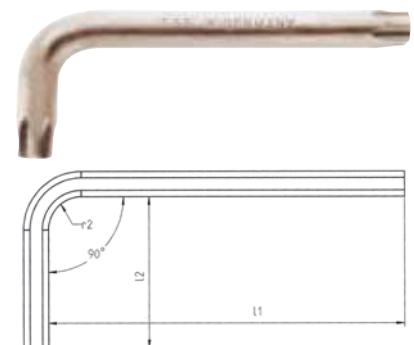



# Schraubendreher Screwdrivers

Sechskant Winkelschraubendrehersatz mit Halter   
Chrom-Vanadium-Stahl, vernickelt, Halter aus Metall,  
mit Kunststoff-Griffschalen

Hexagon keys in clip holder   
chrome vanadium steel, metal holder with plastic

1000 H  
1010 H





Artikel-Nr. Order-No.	Ident-Nr. Ident-No.	Inhalt Contents		
1000 H / 7	I2840	1,5, 2, 2,5, 3, 4, 5, 6	140	I
1000 H / 70	I2841	2,5, 3, 4, 5, 6, 8, 10	350	I
1010 H / 7	I3736	1/16, 5/64, 3/32, 1/8, 5/32, 3/16, 7/32	130	I
1010 H / 70	I3737	3/32, 1/8, 5/32, 3/16, 1/4, 5/16, 3/8	340	I

Sechskant Winkelschraubendrehersatz in  
Plastik-Tasche   
Chrom-Vanadium-Stahl, vernickelt

Hexagon Keys in plastic bag   
chrome vanadium steel, nickel plated

1000 T  
1010 T





Artikel-Nr. Order-No.	Ident-Nr. Ident-No.	Inhalt Contents		
1000 T / 7	I3053	1,5, 2, 2,5, 3, 4, 5, 6	65	I
1000 T / 80	I3056	3, 4, 5, 6, 8, 10, 12	445	I
1000 T / 9	I3063	1,5, 2, 2,5, 3, 4, 5, 6, 8, 10	230	I
1010 T / 8	I3743	1/16, 5/64, 3/32, 1/8, 5/32, 3/16, 7/32, 1/4	110	I
1010 T / 10	I3746	1/16, 5/64, 3/32, 1/8, 5/32, 3/16, 7/32, 1/4, 5/16, 3/8	250	I

Sechskant-Winkelschraubendrehersatz am Ring   
Chrom-Vanadium-Stahl, vernickelt

Hexagon keys on ring   
chrome vanadium steel, nickel plated

1000 R  
1010 R





Artikel-Nr. Order-No.	Ident-Nr. Ident-No.	Inhalt Contents		
1000 / 12 R	I3089	1,5, 2, 2,5, 3, 4, 5, 5,5, 6, 8, 10, 11, 12	445	I
1010 / 12 R	I3756	1/16, 5/64, 3/32, 1/8, 5/32, 3/16, 7/32, 1/4, 5/16, 3/8, 7/16, 1/2	570	I

TX Winkelschraubendrehersatz mit Halter   
Chrom-Vanadium-Stahl, vernickelt, Halter aus Metall,  
mit Kunststoff-Griffschalen

TX keys in clip holder   
chrome vanadium steel, metal holder with plastic

1000 R  
1010 R



Artikel-Nr. Order-No.	Ident-Nr. Ident-No.	Inhalt Contents		
1000 R / 8	I3099	T09, T10, T15, T20, T25, T27, T30, T40	240	I



# Schraubendreher Screwdrivers

- neu entwickeltes, ergonomisches Design
- 2-farbiger Stiftschlüssel Drehhalter
- Hochschlagfester Spezial-Kunststoff
- einfaches Entnehmen der Schlüssel durch patentrechtlich geschützte Drehtechnik
- Drehmodul arretiert in allen 90°-Positionen

- newly developed ergonomic design
- 2-color rotary holder for hexagon keys
- high impact special plastics
- easy removal of the key by a patent rotation technique
- rotating module engages in all 90° positions

Sechskant-Winkelschraubendrehersatz   
in Kunststoffhalter; Chrom-Vanadium-Stahl, vernickelt

Hexagon keys   
in plastic holder; chrome vanadium steel, nickel plated



Artikel-Nr. Order-No.	Ident-Nr. Ident-No.	Inhalt Contents		
I000 SB 9	I0000098030	1,5, 2, 2,5, 3, 4, 5, 6, 8, 10	275	6
I010 SB 10	I0100108030	1/16, 5/64, 3/32, 1/8, 5/32, 3/16, 7/32, 1/4, 5/16, 3/8	300	6

I000 SB  
I010 SB



Sechskant-Winkelschraubendrehersatz   
lange Ausführung  
in Kunststoffhalter; Chrom-Vanadium-Stahl, vernickelt

Hexagon keys   
long version  
in plastic holder; chrome vanadium steel, nickel plated



Artikel-Nr. Order-No.	Ident-Nr. Ident-No.	Inhalt Contents		
I000 LSB 9	I0000198030	1,5, 2, 2,5, 3, 4, 5, 6, 8, 10	445	6
I010 LSB 10	I0100198030	1/16, 5/64, 3/32, 1/8, 5/32, 3/16, 7/32, 1/4, 5/16, 3/8	460	6
I005 LSB 9 mit Kugelkopf	I0050098030	1,5, 2, 2,5, 3, 4, 5, 6, 8, 10	445	6

I000 L SB  
I010 L SB  
I005 SB



Satz TX-Winkelschraubendreher   
Chrom-Vanadium-Stahl, vernickelt

Set of TX keys for TORX screws   
Euro hole, chrome vanadium steel, nickel plated

Artikel-Nr. Order-No.	Ident-Nr. Ident-No.	Inhalt Contents		
I040 N SB	I0400098030	T09, T10, T15, T20, T25, T27, T30, T40	175	1

I040 N SB

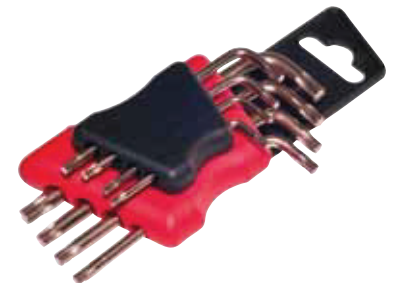





Winkelschraubendreher  
Hexagon keys

# Schraubendreher Screwdrivers

Sechskant-Schraubendreher   
mit Kunststoff-Quergriff, Chrom-Vanadium-Stahl,  
Klinge vernickelt

T-handled hexagon keys   
chrome vanadium steel, blade nickel plated, with  
plastic t-handle

1001 N



Artikel-Nr. Order-No.	Ident-Nr. Ident-No.		 mm	 mm			
1001 N	10010215030		2	100	70	16	10
1001 N	10012515030		2,5	100	70	19	10
1001 N	10010315030		3	100	70	22	10
1001 N	10010415030		4	150	70	41	10
1001 N	10010515030		5	150	70	50	10
1001 N	10010615030		6	150	90	60	10
1001 N	10010815030		8	150	90	107	10
1001 N	10011015030		10	150	110	170	10



Sechskant T-Griff mit Halter   
mit Kunststoff-Quergriff, Chrom-Vanadium-Stahl,  
Klinge vernickelt

T-handled hexagon keys in holder   
chrome vanadium steel, blade nickel plated, with  
plastic t-handle

1001 H







Artikel-Nr. Order-No.	Ident-Nr. Ident-No.	€	Inhalt Contents		
1001 H	10010198030		2, 2,5, 3, 4, 5, 6, 8, 10	500	I



Sechskant-Schraubendreher   
mit Kunststoff-Quergriff, schwarz isolierte Klinge,  
Chrom-Vanadium-Stahl, vernickelt

T-handled hexagon keys   
blade black insulated, chrome vanadium steel,  
nickel plated, with plastic t-handle

1002





Artikel-Nr. Order-No.	Ident-Nr. Ident-No.		 mm		 mm			
1002	10022515030		2,5	2,5	150	70	23	10
1002	10020315030		3	3,0	150	70	27	10
1002	10020415030		4	4,0	150	70	36	10
1002	10020515030		5	5,0	150	70	46	10
1002	10020615030		6	6,0	150	90	74	10
1002	10020815030		8	8,0	150	90	108	10
1002	10021015030		10	10,0	150	110	175	10



TX Winkelschraubendreher   
mit Kunststoff-Quergriff, Chrom-Vanadium-Stahl,  
vernickelt

TX keys   
chrome vanadium steel, nickel plated, with plastic  
t-handle

1006 N

Artikel-Nr. Order-No.	Ident-Nr. Ident-No.	€	 mm	 mm			
1006 N	10060815030		T8	100	70	34	10
1006 N	10060915030		T9	100	70	36	10
1006 N	10061015030		T10	100	70	36	10
1006 N	10061515030		T15	100	70	40	10
1006 N	10062015030		T20	125	90	44	10
1006 N	10062515030		T25	125	90	48	10
1006 N	10063015030		T30	125	90	63	10
1006 N	10064015030		T40	125	110	98	10



TX Winkelschraubendreher mit Halter   
mit Kunststoff-Quergriff, Chrom-Vanadium-Stahl,  
vernickelt

TX keys in holder   
chrome vanadium steel, nickel plated, with plastic  
t-handle

1006 H

Artikel-Nr. Order-No.	Ident-Nr. Ident-No.	€	Inhalt Contents		
1006 H	10060098030		T8, T9, T10, T15, T20, T25, T30, T40	500	I



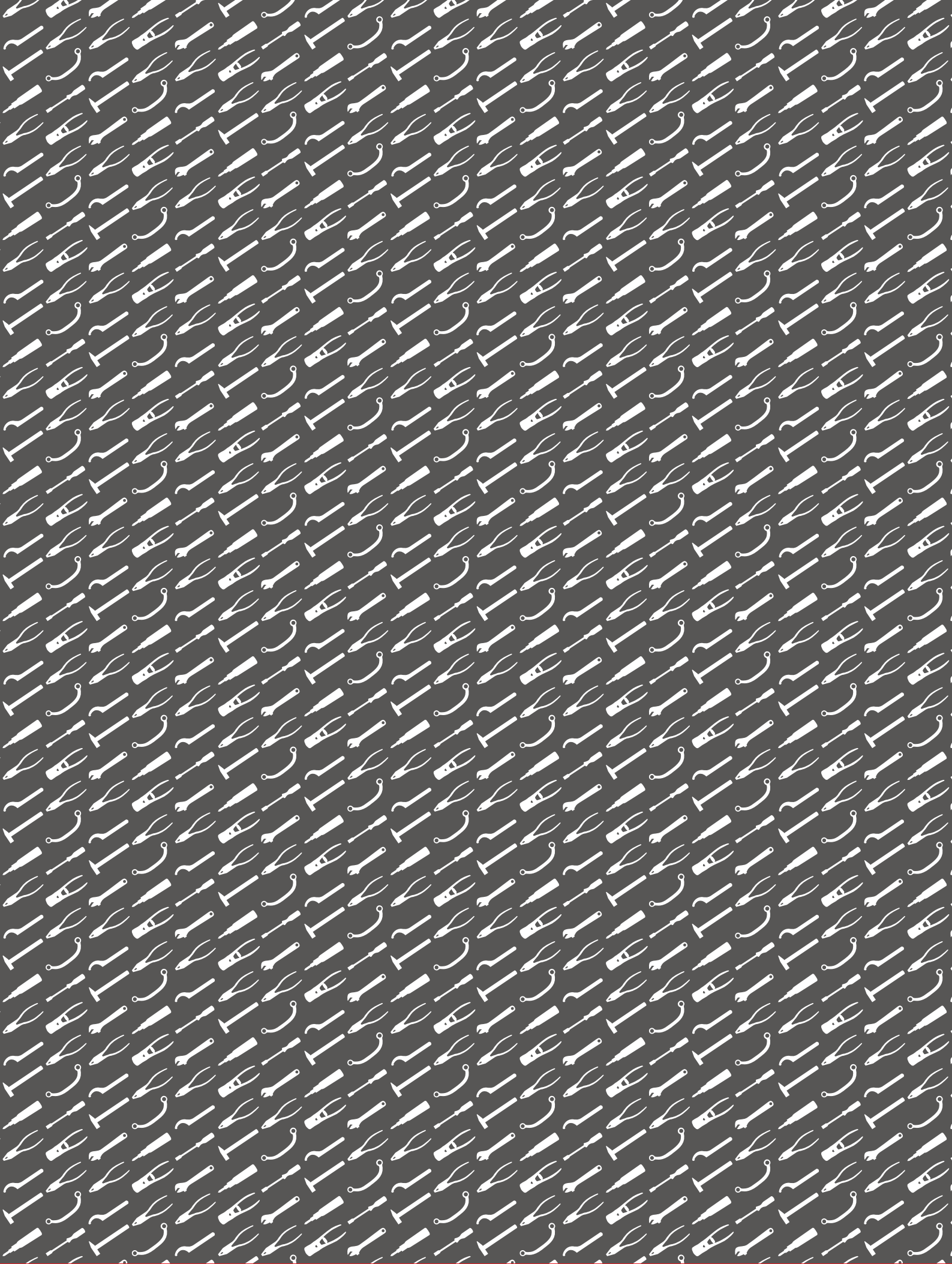

**CARL WALTER Schraubwerkzeug-Fabrik GmbH & Co. KG**

Hahnerberger Straße 82  
D-42349 Wuppertal

Postfach 15 02 44  
D-42340 Wuppertal

Telefon +49(0)202/409 24-0  
Telefax +49(0)202/409 24-98

info@cwalter.de  
www.cwalter.de